

ENEL DISTRIBUIÇÃO GOLÁS



Relatório de Evento em Situação de Emergência

Nº CHI-058

1.	INTRODUÇÃO	3
2.	DEFINIÇÃO	3
3.	RESUMO EXECUTIVO	5
3.1.	RELATÓRIO DE OCORRÊNCIAS DO PERÍODO	5
4.	LISTA DE OCORRÊNCIAS	9
5.	PLOTAGEM DAS OCORRÊNCIAS CONFORME A ESPACIALIZAÇÃO DAS CHUVAS	285
6.	CLIENTES AFETADOS E IMPACTOS GLOBAIS	286
7.	DIAGRAMAS UNIFILARES	288
8.	DEMAIS EVIDÊNCIAS	294
8.1.	DADOS TÉCNICO - OPERACIONAIS ENEL GO	294
8.2.	DADOS CLIMATOLÓGICOS PELO INMET	296
9.	NOTÍCIAS RELACIONADAS	300
10.	LAUDO TÉCNICO	304

1. Introdução

As concessionárias do serviço público de distribuição de energia elétrica devem prover o serviço de forma adequada, buscando sempre a eficiência, conforme disposto na legislação e nos respectivos contratos de concessão.

Dentre a legislação vigente, destacam-se os Procedimentos de Distribuição de Energia Elétrica no Sistema Elétrico Nacional – PRODIST, que consistem em documentos elaborados pela Agência Nacional de Energia Elétrica – ANEEL, com a participação dos agentes de distribuição e de outras entidades e associações do setor elétrico nacional, que normatizam e padronizam as atividades técnicas relacionadas ao funcionamento e desempenho dos sistemas de distribuição de energia elétrica.

O Módulo 8 do PRODIST – Revisão 11, mais especificamente em sua Seção 8.2, regulamenta a qualidade do serviço prestado pelas distribuidoras de energia elétrica, estabelecendo a metodologia para apuração dos indicadores de continuidade e dos tempos de atendimento a ocorrências emergenciais.

O referido regulamento prevê que, na apuração dos indicadores coletivos e individuais deverão ser consideradas todas as interrupções de longa duração que atingirem as unidades consumidoras, admitidas algumas exceções (denominadas expurgos), que podem ser encontradas no Item 5.6.2.2 da seção 8.2 do Módulo 8 do PRODIST, transcrito abaixo:

5.6.2.2 Na apuração dos indicadores DEC e FEC devem ser consideradas todas as interrupções, admitidas apenas as seguintes exceções:

i. falha nas instalações da unidade consumidora que não provoque interrupção em instalações de terceiros;

ii. interrupção decorrente de obras de interesse exclusivo do consumidor e que afete somente a unidade consumidora do mesmo;

iii. Interrupção em Situação de Emergência;

iv. suspensão por inadimplemento do consumidor ou por deficiência técnica e/ou de segurança das instalações da unidade consumidora que não provoque interrupção em instalações de terceiros, previstas em regulamentação;

v. vinculadas a programas de racionamento instituídos pela União;

vi. ocorridas em Dia Crítico;

vii. oriundas de atuação de Esquema Regional de Alívio de Carga estabelecido pelo ONS. [grifos nossos]

Para os casos de expurgo por Interrupção em Situação de Emergência (ISE), a alínea “h” do Item 5.12.1 da seção 8.2 do Módulo 8 do PRODIST estabelece a obrigatoriedade das distribuidoras em disponibilizar, em seu sítio eletrônico, relatórios digitais com as evidências do evento que tenha gerado tais interrupções enquadradas no inciso iii do Item 5.6.2.2 do mesmo.

Nesta seara, o presente documento, visa apresentar as evidências de um evento ocorrido na área de concessão da Eletropaulo, bem como informações relevantes a respeito das interrupções em Situação de Emergência decorrentes do mesmo.

Destaca-se que, para o entendimento completo das regras de apuração dos indicadores de continuidade e expurgos, faz-se necessário também a observação das regras contidas nos Módulos 1 e 6 do PRODIST. Todos os módulos destes procedimentos encontram-se disponíveis para consulta no site da ANEEL (www.aneel.gov.br) e as principais definições relacionadas ao tema estão contidas no item 2 deste documento.

2. Definição

Seção 1.2 do Módulo 1 do PRODIST – Revisão 10

2.198 Evento

Acontecimento que afete as condições normais de funcionamento de uma rede elétrica, podendo gerar uma ou mais interrupções no fornecimento de energia.

2.131 e 2.158 DIC

Duração de interrupção individual por unidade consumidora, ou seja, intervalo de tempo que, no período de apuração, em cada unidade consumidora ou ponto de conexão ocorreu descontinuidade da distribuição de energia elétrica.

2.216 e 2.220 FIC

Frequência de interrupção individual por unidade consumidora, ou seja, Número de interrupções ocorridas, no período de apuração, em cada unidade consumidora ou ponto de conexão.

2.87 Consumidor Hora Interrompido (CHI):

Somatório dos DICs dos consumidores atingidos por interrupção no fornecimento de energia, expresso em horas e centésimos de horas.

2.251 Interrupção em Situação de Emergência:

Interrupção originada no sistema de distribuição, resultante de Evento que comprovadamente impossibilite a atuação imediata da distribuidora e que não tenha sido provocada ou agravada por esta e que seja:

- Decorrentes de evento associado a Decreto de Declaração de Situação de Emergência ou Estado de Calamidade Pública emitido por órgão competente; ou
- Decorrentes de Evento cuja soma do CHI das interrupções ocorridas no sistema de distribuição seja superior ao calculado conforme equação a seguir:

$$2.612 \times N^{0,35}$$

N – número de unidades consumidoras faturadas e atendidas em BT ou MT, com 2 (duas) casas decimais, do mês de outubro do ano anterior ao período de apuração

3. Resumo Executivo

O Presente Relatório tem como objetivo a incorporação de informações que sejam relevantes para que se possa fazer a devida associação aos dados contidos no documento objeto da classificação de Situação de Emergência caracterizada pelo Módulo 8 do Prodist. Este enquadramento se apresenta na maioria das vezes em condições climáticas adversas com severidade dos fatores inerentes a situação, caracterizado na maioria dos casos por fortes ventos e chuvas de grande intensidade e continuidade.

Durante a manhã do dia 06/12/2020 – domingo – Nuvens de tempestade associadas a presença de uma ZCAS (Zona de Convergência do Atlântico Sul), avançaram sobre o estado de Goiás, na área de concessão da ENEL GO.

Conforme informações do Climatempo Meteorologia, o Instituto Nacional de Meteorologia (INMET) detectou rajadas de vento acima de 50km/h registradas por estações representativas da área de concessão da ENEL Distribuição Goiás. Na estação de Alto Araguaia, o maior valor registrado foi de 91,1 km/h entre as 16h e 17h do dia 09 de dezembro de 2020, classificada como tempestade, segundo a escala Beaufort.

O sistema de detecção da EarthNetworks registrou 307.573 descargas atmosféricas (73.377 nuvem-solo e 234.196 nuvem-nuvem) sobre a área de concessão da ENEL em Goiás entre as 09h45 do dia 06 de dezembro de 2020 e 00h20 do dia 13 de dezembro de 2020, causando grande instabilidade na rede.

Chuva forte foi registrada pelo INMET em estações representativas da área de concessão da ENEL Distribuição Goiás. Na estação de Formosa foram acumulados 85,4 mm de chuva entre a manhã do dia 08 e a manhã do dia 09 de dezembro de 2020, aproximadamente 31% da média climatológica para o mês na região.

3.1. Relatório de Ocorrências do período

Em todo o Estado de Goiás verificou-se também que a intensidade da chuva e dos ventos danificaram a rede de distribuição de energia elétrica em diversos pontos, registrando aproximadamente 682 mil clientes com interrupção no fornecimento de energia elétrica devido a eventos relacionados ao temporal, afetando 243 municípios e 331 Subestações.

Para otimizar o volume de atendimentos e reduzir os tempos de interrupção foram mobilizados os recursos extras da empresa que aumentou o contingente em relação a situação normal de operação. O acompanhamento da quantidade de equipes e o Tempo Médio de Atendimento podem ser consultados na Pág.08 do Relatório em anexo.

O impacto e severidade do evento estão relatados em artigos de mídia, como fotos e reportagens que demonstram os danos na Rede de Distribuição, oriundos dos eventos climáticos no período. Eventos estes que afetaram 682.021 consumidores com CHI de 2.868.123,07 superior ao de 482.597,74 estabelecido como limite para definição de Situação de Emergência, conforme resumo das informações obrigatórias.

Empresa		ENEL DISTRIBUIÇÃO GOIÁS			
Código do Relatório		CHI-058 - ENEL DISTRIBUIÇÃO GOIÁS			
Evento:		TEMPORAL NA AREA DE CONCESSÃO DA ENEL DISTRIBUIÇÃO GOIAS			
Código COBRADE:	1.3.1.2.0	Data Início	06/12/2020	Hora início	09h30
Código do Evento:	CHI-058-ENEL GO	Data Término	13/12/2020	Hora Término	08h59
Valor CHI (Limite e Real)	482.597,74		2.868.123,07		
Código do Decreto (Se Houver):					
Quantidade de Interrupções (Evento)		14.064			
Início 1ª Incidência (Data e Hora)	06/12/2020 09:31	Subestações Atingidas	ABADIANIA / ABC / ACREUNA / ADELANDIA / AEROPORTO / AGUA LIMPA (MARZAGAO) / AGUAS LINDAS / ALEXANIA / ALEXANIA TRANSMISSAO / ALMERINDONOPOLIS / ALOANDIA / ALPHAVILLE / ALTO BURITI / ALTO HORIZONTE / ALTO PARAISO DE GOIAS / ALVORADA DO NORTE / AMERICANO (RIO VERDE) / AMERICANO DO BRASIL / AMORINOPOLIS / ANAPOLIS UNIVERSITARIA / ANHANGUERA / ANICUNS / ANTONIO DO VITTO / APARECIDA DO RIO DOCE / APORE / ARACU / ARAGARCAS / ARAGOIANIA / ARAGUAPAZ / ARARAS / AREIAS / ARENOPOLIS / ARUANA / ARUANA (TRANSMISSAO) / ASA BRANCA / ATLANTICO / AURILANDIA / AVELINOPOLIS / BACURI (RIO VERDE) / BARBOSELANDIA / BARCELONA / BARREIRO (PORANGATU) / BARRO ALTO / BELA VISTA (TRANSMISSAO) / BOA VISTA / BOM JARDIM / BOM JESUS DE GOIAS / BONFINOPOLIS / BONITO / BONOPOLIS / BONSUCESSO (RIO VERDE) / BRAZABRANTES / BRITANIA / BRITANIA (TRANSMISSAO) / BURITI ALEGRE / BURITI DE GOIAS / BURITIZINHO / CABECEIRAS / CABRIUVA (RIO VERDE) / CACHOEIRA ALTA / CACHOEIRA DOURADA / CACHOEIRA NOVA / CACHOEIRINHA (ITARUMA) / CACU / CAIAPONIA / CALCILANDIA / CALDAS NOVAS / CALDAZINHA / CAMPESTRE / CAMPINAS / CAMPINORTE / CAMPO ALEGRE DE GOIAS / CAMPO LIMPO DE GOIAS / CAMPO NOVO / CAMPOS BELOS / CAMPOS VERDES / CARAIBAS / CARAJAS / CASTELANDIA / CATALAO / CATURAI / CEBRASA FABRICA DA AMBEV / CEMAT/BALIZA / CEPAIGO / CEZARINA / CHAPADAO DO CEU / CIDADE OCIDENTAL / COCALZINHO / COLINACU / CORREGO ALEGRE / CORREGO DO OURO / CORUMBA / CORUMBAIBA / CRISTALINA / CRISTALINA TRANSMISSAO / CRISTIANOPOLIS / CRIXAS / CROMINIA / CUMARI / DAIA - ANAPOLIS / DAMOLANDIA / DAVINOPOLIS / DESFECHO / DESTILARIA BRASIL CENTRAL / DIMIC / DIORAMA / DORCELINO PEIXOTO DE MORAES / DOVERLANDIA / EDEALINA / EDEIA / ENERSUL / ESTANIFERA / ESTRELA DO NORTE / FAINA / FAZENDA CANADA / FAZENDA NOVA / FERROVIARIO / FIRMINOPOLIS / FLORES DE GOIAS / FORMIGA / FORMOSO / FRONTEIRA / GAMELEIRA / GIRASSOL / GOIANAPOLIS / GOIANDIRA / GOIANESIA / GOIANIA LESTE / GOIANIRA / GOIAS / GOIATUBA / GOUVERLANDIA / GOYA / GUAPO / HEITORAI / HIDROLANDIA / HIDROLINA / IACIARA / INACIOLANDIA / INDEPENDENCIA / INDIARA / INHUMAS / IPAMERI / IPEGUARI / IPORA / ISRAELANDIA / ITABERAI / ITAGUARI / ITAGUARU / ITAJA / ITAPACI / ITAPACI (TRANSMISSAO) / ITAPIRAPUA / ITAPURANGA / ITAPURANGA (TRANSMISSAO) / ITARUMA / ITAUCU / ITIQUIRA (FORMOSA) / ITUMBIARA NOVA / ITUMBIARA VELHA / JACILANDIA / JANDAIA / JARAGUA / JARANAPOLIS / JATAI / JAUPACI / JESUPOLIS / JOVIANIA / JUNDIAI / JURUMIRIM / JUSCELANDIA / JUSSARA / LAGES / LAGOA DA SERRA / LAGOA DO BAUZINHO (RIO VERDE) / LEOPOLDO DE BULHOES / LUZIANIA / LUZIANIA INDUSTRIAL / MAIRIPOTABA / MAMBAI / MARA ROSA / MARAJOARA / MARCIANOPOLIS / MARIAPOLIS (PADRE BERNARDO) / MARZAGAO / MATO GRANDE / MATRINCHA / MAURILANDIA / MEIA PONTE / MINACU / MINEIROS / MINEIROS TRANSMISSAO / MOIPORA / MONTE ALEGRE / MONTES CLAROS DE GOIAS / MONTIVIDIU T / MORRINHOS / MORRO AGUDO / MOSSAMEDES / MOZARLANDIA / MOZARLANDIA (TRANSMISSAO) / MUNDO NOVO DE GOIAS / MUTUNOPOLIS / NAVESLANDIA (JATAI) / NAZARIO / NEROPOLIS / NIQUELANDIA / NIQUELANDIA 69KV / NOVA AMERICA / NOVA AURORA / NOVA CRIXAS (TRANSMISSAO) / NOVA IGUACU / NOVA PONTE / NOVA VENEZA / NOVO BRASIL / NOVO GAMA / NOVO PLANALTO / OLHOS DAGUA / OLOANA / ORIZONA / OURO VERDE DE GOIAS / OUVIDOR / PACAEMBU (NOVO GAMA) / PADRE BERNARDO / PALESTINA / PALMEIRAS / PALMEIRAS DE GOIAS / PALMELO / PALMINOPOLIS / PAMPLONA / PANAMA / PARANA / PARANAIBA / PARANAIGUARA / PARAUNA SE ALTA TENSAO / PARQUE DAS EMAS (MINEIROS) / PARQUE DAS NACOES / PEROLANDIA / PETROLINA / PILAR / PILOANDIA / PIRACANJUBA / PIRANHAS T / PIRENOPOLIS / PIRES BELO / PIRES DO RIO / PLANALTINA / PLANALTINA (TRANSMISSAO) / PLANALTO / PONTALINA / PORANGATU / PORTEIRAO / PORTELANDIA / PORTO SAO SIMAO / POSSE / POSSELANDIA / PROFESSOR JAMIL / QUEBRA LINHA / QUIRINOPOLIS / REAL / RETIRO / GOIAS / RIO CLARO JATAI MONTIVIDIU / RIO DO PEIXE / RIO DOS BOIS (MAURILANDIA) / RIO PRETO / RIO QUENTE / RIO VERDE / RIO VERMELHO / RIVERLANDIA (RIO VERDE) / ROCHEDO (UEH) / RUBIATABA / SANCLERLANDIA / SANTA BARBARA / SANTA FE DE GOIAS / SANTA HELENA / SANTA RITA DO ARAGUAIA / SANTA ROSA / SANTA ROSA DE GOIAS / SANTA ROSA DO MEIA PONTE / SANTA TEREZA DE GOIAS / SANTA TEREZINHA / SANTANA / SANTO ANTONIO DA BARRA / SANTO ANTONIO DE GOIAS / SANTO		

			ANTONIO DO DESCOBERTO / SAO BARTOLOMEU / SAO DOMINGOS / SAO FRANCISCO DE GOIAS / SAO GABRIEL DE GOIAS / SAO JOAO D ALIANCA / SAO JOAO DA PARAUNA / SAO LUIZ DOS MONTES BELOS / SAO MIGUEL DO ARAGUAIA / SAO MIGUEL DO PASSA QUATRO / SAO SIMAO / SENADOR CANEDO TRANSMISSAO / SERRA AZUL (JATAI) / SERRA DE CALDAS / SERRANOPOLIS / SILVANIA / SITIO DABADIA / SOUZALANDIA / SUCURI / TAIOBA / TAQUARAL / TAQUARI / TEREZOPOLIS / TERRA VERMELHA / TRAJANOPOLIS (PADRE BERNARDO) / TRES BARRAS / TRES RANCHOS / TRINDADE / TUCUNARE / TURVANIA / TURVELANDIA / URU / URUACU / URUTAI / USINA DE ACUCAR DE GOIANESIA / USINA MAMBAI / VALPARAISO / VARJAO / VENDA SECA / VIANOPOLIS / VICENTINOPOLIS / VILA BOA / VILA CORUMBA / VILA PROPICIO / XAVANTES / XIXA / ZELANDIA
Início Ultima Incidência (Data e Hora)	13/12/2020 08:57		
Média de Duração das Incidências (h)	8,51		
Duração da Incidência mais longa (h)	103,15		
Total de Clientes afetados	682.021	Municípios Atingidos	ABADIA DE GOIAS / ABADIANIA / ACREUNA / ADELANDIA / AGUA FRIA DE GOIAS / AGUA LIMPA / AGUAS LINDAS DE GOIAS / ALEXANIA / ALOANDIA / ALTO HORIZONTE / ALTO PARAISO DE GOIAS / ALVORADA DO NORTE / AMARALINA / AMERICANO DO BRASIL / AMORINOPOLIS / ANAPOLIS / ANHANGUERA / ANICUNS / APARECIDA DE GOIANIA / APARECIDA DO RIO DOCE / APORE / ARACU / ARAGARCAS / ARAGOIANIA / ARAGUAPAZ / ARENAPOLIS / ARUANA / AURILANDIA / AVELINOPOLIS / BALIZA / BARRO ALTO / BELA VISTA DE GOIAS / BOM JARDIM DE GOIAS / BOM JESUS DE GOIAS / BONFINOPOLIS / BONOPOLIS / BRAZABRANTES / BRITANIA / BURITI ALEGRE / BURITI DE GOIAS / BURITINOPOLIS / CABECEIRAS / CACHOEIRA ALTA / CACHOEIRA DE GOIAS / CACHOEIRA DOURADA / CACU / CAIAPONIA / CALDAS NOVAS / CALDAZINHA / CAMPESTRE DE GOIAS / CAMPINACU / CAMPINORTE / CAMPO ALEGRE DE GOIAS / CAMPO LIMPO / CAMPOS BELOS / CAMPOS VERDES / CARMO DO RIO VERDE / CASTELANDIA / CATALAO / CATURAI / CAVALCANTE / CEZARINA / CHAPADAO DO CEU / CIDADE OCIDENTAL / COCALZINHO DE GOIAS / COLINAS DO SUL / CORREGO DO OURO / CORUMBA DE GOIAS / CORUMBAIBA / CRISTALINA / CRISTIANOPOLIS / CRIXAS / CROMINIA / CUMARI / DAMIANOPOLIS / DAMOLANDIA / DAVINOPOLIS / DIORAMA / DISTRITO FEDERAL / DIVINOPOLIS DE GOIAS / DOVERLANDIA / EDEALINA / EDEIA / ESTRELA DO NORTE / FAINA / FAZENDA NOVA / FIRMINOPOLIS / FLORES DE GOIAS / FORMOSA / FORMOSO / GAMELEIRA DE GOIAS / GOIANAPOLIS / GOIANDIRA / GOIANESIA / GOIANIA / GOIANIRA / GOIAS / GOIATUBA / GOUVELANDIA / GUAPO / GUARAITA / GUARANI DE GOIAS / GUARINOS / HEITORAI / HIDROLANDIA / HIDROLINA / IACIARA / INACIOLANDIA / INDIARA / INHUMAS / IPAMERI / IPIRANGA DE GOIAS / IPORA / ISRAELANDIA / ITABERAI / ITAGUARI / ITAGUARU / ITAJA / ITAPACI / ITAPIRAPUA / ITAPURANGA / ITARUMA / ITAUCU / ITUMBIARA / IVOLANDO / JANDAIA / JARAGUA / JATAI / JAUPACI / JESUPOLIS / JOVIANIA / JUSSARA / LAGOA SANTA / LEOPOLDO DE BULHOES / LUZIANIA / MAIRIPOTABA / MAMBAI / MARA ROSA / MARZAGAO / MATRINCHA / MAURILANDIA / MIMOSO DE GOIAS / MINACU / MINEIROS / MOIPORA / MONTE ALEGRE DE GOIAS / MONTES CLAROS DE GOIAS / MONTIVIDIU / MONTIVIDIU DO NORTE / MORRINHOS / MORRO AGUDO DE GOIAS / MOSSAMEDES / MOZARLANDIA / MUNDO NOVO DE GOIAS / MUTUNOPOLIS / NAZARIO / NEROPOLIS / NIQUELANDIA / NOVA AMERICA / NOVA AURORA / NOVA CRIXAS / NOVA GLORIA / NOVA IGUACU DE GOIAS / NOVA ROMA / NOVA VENEZA / NOVO BRASIL / NOVO GAMA / NOVO PLANALTO / ORIZONA / OURO VERDE DE GOIAS / OUVIDOR / PADRE BERNARDO / PALESTINA DE GOIAS / PALMEIRAS DE GOIAS / PALMELO / PALMINOPOLIS / PANAMA / PARANAIGUARA / PARAUNA / PEROLANDIA / PETROLINA DE GOIAS / PILAR DE GOIAS / PIRACANJUBA / PIRANHAS / PIRENOPOLIS / PIRES DO RIO / PLANALTINA / PONTALINA / PORANGATU / PORTEIRAO / PORTELANDIA / POSSE / PROFESSOR JAMIL SAFADY / QUIRINOPOLIS / RIO QUENTE / RIO VERDE / RUBIATABA / SANCLERLANDIA / SANTA BARBARA DE GOIAS / SANTA CRUZ DE GOIAS / SANTA FE DE GOIAS / SANTA HELENA DE GOIAS / SANTA ISABEL / SANTA RITA DO ARAGUAIA / SANTA RITA DO NOVO DESTINO / SANTA ROSA DE GOIAS / SANTA TEREZA DE GOIAS / SANTA TEREZINHA DE GOIAS / SANTO ANTONIO DA BARRA / SANTO ANTONIO DE GOIAS / SANTO ANTONIO DO DESCOBERTO / SAO DOMINGOS / SAO FRANCISCO DE GOIAS / SAO JOAO D ALIANCA / SAO JOAO DA PARAUNA / SAO LUIS DE MONTES BELOS / SAO LUIZ DO NORTE / SAO MIGUEL DO ARAGUAIA / SAO MIGUEL DO PASSA QUATRO / SAO SIMAO / SENADOR CANEDO / SERRANOPOLIS / SILVANIA / SIMOLANDIA / SITIO D ABADIA / TAQUARAL DE GOIAS / TERESINA DE GOIAS / TEREZOPOLIS DE GOIAS / TRES RANCHOS / TRINDADE / TROMBAS / TURVANIA / TURVELANDIA / UIRAPURU / URUACU / URUANA / URUTAI / VALPARAISO DE GOIAS / VARJAO / VIANOPOLIS / VICENTINOPOLIS / VILA BOA / VILA PROPICIO

DANOS CAUSADOS			
Equipamentos Danificado	Importância para o Sistema	Local	Quantidade
Disjuntor/Religador Operado	Proteção do Alimentador	Área de Concessão	223
Chaves Fusíveis Operada	Proteção de Ramais de Alimentadores	Área de Concessão	4.018
Transformador Operado	Proteção do Transformador	Área de Concessão	3.169

Relato técnico sobre a Intervenção realizada em Goiânia e Região Metropolitana									
Informações sobre Equipes	06/12	07/12	08/12	09/12	10/12	11/12	12/12	13/12	
Quantidade Usual	776	1.104	1.104	1.104	1.104	1.104	932	768	turmas
Quantidade Adicional	21	10	18	58	37	33	0	0	turmas
Quantidade Total	797	1.114	1.122	1.162	1.141	1.137	932	768	turmas
<u>Tempos Médios</u>									
Preparação	5,11	4,57	5,80	5,78	4,33	3,79	4,89	4,40	Horas
Deslocamento	1,05	0,72	0,80	0,73	0,94	0,73	1,01	1,09	Horas
Execução	1,14	0,74	1,03	0,79	0,97	0,74	0,89	0,89	Horas
TMAE	7,31	6,02	7,62	7,30	6,24	5,26	6,78	6,38	Horas

Principais Dificuldades Encontradas:

Chuvas com ventos fortes provocaram muitos pontos de alagamento e enxurrada, trânsito impedido por vários semáforos desligados dificultando a chegada ao atendimento das ocorrências emergenciais. Em determinadas regiões, decorrente dos fortes ventos, houve o tombamento de árvores nas estruturas de alimentação de média tensão, danos em ramais de ligação dos clientes, impedimentos

Empresa	ENEL DISTRIBUIÇÃO GOIAS		
Valor CHI (Limite e Real)	482.597,74		2.868.123,07

4. Lista de Ocorrências

DOC ORIGEM	MIUNICIPIO	EQP_ORIGEM	CONJUNTO	INI_OCORRENC	FIM_OCORRENC	DT_INI_EVENTO	DT_FIM_EVENTO	DURAÇ	UC INT	CHI	EXPURGO
20201225201	PORANGATU	840129701	PORANGATU	06/12/2020 09:31	07/12/2020 04:58	06/12/2020 09:31	07/12/2020 04:58	19,45	1	19,45	CHI
20201225786	BONOPOLIS	BX12233111	SAO MIGUEL DO ARAGUAIA	06/12/2020 09:31	07/12/2020 08:47	06/12/2020 09:31	07/12/2020 08:47	23,25	3	69,76	CHI
20201225786	NOVO PLANALTO	BX12233111	SAO MIGUEL DO ARAGUAIA	06/12/2020 09:31	07/12/2020 08:47	06/12/2020 09:31	07/12/2020 08:47	23,25	2	46,51	CHI
20201225212	PORANGATU	TA21249545	NOVO PLANALTO	06/12/2020 09:32	06/12/2020 17:41	06/12/2020 09:32	06/12/2020 17:41	8,14	1	8,14	CHI
20201225233	NOVA CRIXAS	NA12126918	NOVA CRIXAS	06/12/2020 09:34	06/12/2020 11:14	06/12/2020 09:34	06/12/2020 11:14	1,66	10	16,59	CHI
20201225268	ALTO PARAISO DE GOIAS	BF21232055	NIQUELANDIA SUBTRANSMISSAO	06/12/2020 09:39	06/12/2020 15:58	06/12/2020 09:39	06/12/2020 15:58	6,32	2	12,63	CHI
20201226430	PORANGATU	PO12202421	PORANGATU	06/12/2020 09:41	07/12/2020 08:24	06/12/2020 09:41	07/12/2020 08:24	22,71	6	136,28	CHI
20201228518	PORANGATU	PO12378923	PORANGATU	06/12/2020 09:41	07/12/2020 07:31	06/12/2020 09:41	07/12/2020 07:31	21,83	2	43,66	CHI
20201225425	TROMBAS	TB12181581	PORANGATU	06/12/2020 09:42	07/12/2020 17:25	06/12/2020 09:42	07/12/2020 17:25	31,71	8	253,66	CHI
20201225301	PORANGATU	PO21257849	MARA ROSA	06/12/2020 09:45	06/12/2020 14:03	06/12/2020 09:45	06/12/2020 14:03	4,29	1	4,29	CHI
20201225344	MINACU	IH12202490	MINACU	06/12/2020 09:53	07/12/2020 15:24	06/12/2020 09:53	07/12/2020 15:24	29,52	3	88,55	CHI
20201225354	ESTRELA DO NORTE	ET21145243	MARA ROSA	06/12/2020 09:55	07/12/2020 16:31	06/12/2020 09:55	07/12/2020 16:31	30,59	1	30,59	CHI
20201226723	RUBIATABA	RB12372516	RUBIATABA	06/12/2020 09:59	06/12/2020 16:14	06/12/2020 09:59	06/12/2020 16:14	6,25	156	975,00	CHI
20201226723	ARAGUAPAZ	RB12372516	RUBIATABA	06/12/2020 09:59	06/12/2020 16:14	06/12/2020 09:59	06/12/2020 16:14	6,25	1	6,25	CHI
20201226723	MORRO AGUDO DE GOIAS	RB12372516	RUBIATABA	06/12/2020 09:59	06/12/2020 16:14	06/12/2020 09:59	06/12/2020 16:14	6,25	14	87,50	CHI
202012179344	SITIO D ABADIA	FB11285742	IACIARA S2	06/12/2020 10:01	07/12/2020 15:27	06/12/2020 10:01	06/12/2020 21:48	11,79	2	23,57	CHI
202012179344	FLORES DE GOIAS	FB11277942	IACIARA S2	06/12/2020 10:01	07/12/2020 15:27	06/12/2020 11:05	06/12/2020 21:48	10,72	1	10,72	CHI
202012179344	SITIO D ABADIA	FB11277843	IACIARA S2	06/12/2020 10:01	07/12/2020 15:27	06/12/2020 18:42	06/12/2020 21:48	3,10	1	3,10	CHI
202012179344	FLORES DE GOIAS	FB21338284	IACIARA S2	06/12/2020 10:01	07/12/2020 15:27	06/12/2020 12:54	07/12/2020 15:27	26,55	1	26,55	CHI
20201226246	TROMBAS	TB12247392	PORANGATU	06/12/2020 10:02	07/12/2020 09:05	06/12/2020 10:02	07/12/2020 09:05	23,04	13	299,57	CHI
20201225429	ITAPACI	100079933	ITAPACI	06/12/2020 10:03	06/12/2020 11:55	06/12/2020 10:03	06/12/2020 11:55	1,87	1	1,87	CHI
20201225535	FORMOSO	ET12168852	MARA ROSA	06/12/2020 10:07	06/12/2020 19:43	06/12/2020 10:07	06/12/2020 19:43	9,59	2	19,17	CHI
20201225535	ESTRELA DO NORTE	ET12168852	MARA ROSA	06/12/2020 10:07	06/12/2020 19:43	06/12/2020 10:07	06/12/2020 19:43	9,59	4	38,34	CHI
20201226583	IACIARA	IA12000014	IACIARA S1	06/12/2020 10:14	06/12/2020 17:35	06/12/2020 10:14	06/12/2020 17:35	7,34	24	176,25	CHI
20201225506	CAMPINACU	UC12269887	MARA ROSA	06/12/2020 10:16	06/12/2020 13:35	06/12/2020 10:16	06/12/2020 13:35	3,33	7	23,28	CHI
20201225518	ALTO HORIZONTE	AJ12262881	SANTA TEREZINHA	06/12/2020 10:18	06/12/2020 16:25	06/12/2020 10:18	06/12/2020 16:25	6,10	1	6,10	CHI
20201225519	NOVA CRIXAS	NA21093378	NOVA CRIXAS	06/12/2020 10:19	06/12/2020 13:32	06/12/2020 10:19	06/12/2020 13:32	3,22	1	3,22	CHI
20201225564	IACIARA	IA21090934	IACIARA S2	06/12/2020 10:24	06/12/2020 18:44	06/12/2020 10:24	06/12/2020 18:44	8,32	1	8,32	CHI
20201225829	PORANGATU	PO21262608	PORANGATU	06/12/2020 10:26	06/12/2020 15:58	06/12/2020 10:26	06/12/2020 15:58	5,53	1	5,53	CHI
20201225580	NIQUELANDIA	NQ21204149	NIQUELANDIA SUBTRANSMISSAO	06/12/2020 10:28	06/12/2020 17:02	06/12/2020 10:28	06/12/2020 17:02	6,55	1	6,55	CHI
20201225587	NIQUELANDIA	NQ12280469	URUACU	06/12/2020 10:29	06/12/2020 14:09	06/12/2020 10:29	06/12/2020 14:09	3,65	3	10,96	CHI
20201225753	PORANGATU	TA12114216	NOVO PLANALTO	06/12/2020 10:29	07/12/2020 13:47	06/12/2020 10:29	07/12/2020 13:47	27,30	6	163,78	CHI
20201226213	PLANALTINA	PI12218356	PLANALTINA	06/12/2020 10:29	06/12/2020 17:04	06/12/2020 10:29	06/12/2020 17:04	6,58	31	203,89	CHI
20201226245	FORMOSO	TB12185317	PORANGATU	06/12/2020 10:33	07/12/2020 13:00	06/12/2020 10:33	07/12/2020 13:00	26,45	5	132,23	CHI
20201226245	TROMBAS	TB12185317	PORANGATU	06/12/2020 10:33	07/12/2020 13:00	06/12/2020 10:33	07/12/2020 13:00	26,45	1	26,45	CHI
20201225666	SAO MIGUEL DO ARAGUAIA	SM10388763	SAO MIGUEL DO ARAGUAIA	06/12/2020 10:38	07/12/2020 16:30	06/12/2020 10:43	06/12/2020 22:14	11,52	49	564,30	CHI
20201225666	SAO MIGUEL DO ARAGUAIA	SM10388763	SAO MIGUEL DO ARAGUAIA	06/12/2020 10:38	07/12/2020 16:30	06/12/2020 10:40	07/12/2020 16:30	29,83	127	3788,02	CHI
20201225666	SAO MIGUEL DO ARAGUAIA	SM10388763	SAO MIGUEL DO ARAGUAIA	06/12/2020 10:38	07/12/2020 16:30	06/12/2020 10:43	07/12/2020 16:30	29,78	64	1905,88	CHI
20201225666	SAO MIGUEL DO ARAGUAIA	SM13375314	SAO MIGUEL DO ARAGUAIA	06/12/2020 10:38	07/12/2020 16:30	06/12/2020 10:43	07/12/2020 16:30	29,78	96	2858,83	CHI
20201225913	SAO JOAO D ALIANCA	BF12349123	FLORES DE GOIAS	06/12/2020 10:40	06/12/2020 17:45	06/12/2020 10:40	06/12/2020 17:45	7,08	2	14,16	CHI
20201225913	ALTO PARAISO DE GOIAS	BF12349123	FLORES DE GOIAS	06/12/2020 10:40	06/12/2020 17:45	06/12/2020 10:40	06/12/2020 17:45	7,08	4	28,32	CHI
20201227949	FORMOSA	FA12330238	ITUIQUIRA	06/12/2020 10:40	07/12/2020 16:01	06/12/2020 10:40	07/12/2020 16:01	29,34	2	58,68	CHI
20201225691	GUARINOS	GG12318446RE	URUACU	06/12/2020 10:46	07/12/2020 02:18	06/12/2020 10:46	07/12/2020 02:18	15,52	1	15,52	CHI
20201225691	PILAR DE GOIAS	GG12318446RE	URUACU	06/12/2020 10:46	07/12/2020 02:18	06/12/2020 10:46	07/12/2020 02:18	15,52	118	1831,65	CHI
20201225691	SANTA TEREZINHA DE GOIAS	GG12318446RE	URUACU	06/12/2020 10:46	07/12/2020 02:18	06/12/2020 10:46	07/12/2020 02:18	15,52	4	62,09	CHI
20201225780	SAO MIGUEL DO ARAGUAIA	SM12151000	SAO MIGUEL DO ARAGUAIA	06/12/2020 10:48	06/12/2020 13:16	06/12/2020 10:48	06/12/2020 13:16	2,46	19	46,73	CHI
20201225699	FLORES DE GOIAS	FB21334129	FLORES DE GOIAS	06/12/2020 10:49	07/12/2020 20:40	06/12/2020 10:49	07/12/2020 20:40	33,85	1	33,85	CHI

20201225900	PORANGATU	PO12057986	PORANGATU	06/12/2020 10:49	06/12/2020 15:38	06/12/2020 10:49	06/12/2020 15:38	4,81	148	711,26	CHI
20201225716	PORANGATU	PO21192324	PORANGATU	06/12/2020 10:51	06/12/2020 23:17	06/12/2020 10:51	06/12/2020 23:17	12,42	1	12,42	CHI
20201225721	NIQUELANDIA	NQ12262927	URUACU	06/12/2020 10:54	06/12/2020 20:07	06/12/2020 10:54	06/12/2020 20:07	9,21	6	55,29	CHI
20201225790	NIQUELANDIA	NQ12239432	URUACU	06/12/2020 10:57	07/12/2020 12:59	06/12/2020 10:57	06/12/2020 23:43	12,77	15	191,48	CHI
20201225790	NIQUELANDIA	NQ12239432	URUACU	06/12/2020 10:57	07/12/2020 12:59	06/12/2020 10:57	07/12/2020 12:59	26,04	6	156,24	CHI
20201225767	COCALZINHO DE GOIAS	ZN12205828	AGUAS LINDAS DE GOIAS S2	06/12/2020 11:04	06/12/2020 17:28	06/12/2020 11:04	06/12/2020 17:28	6,39	17	108,65	CHI
20201225775	URUACU	UR12364091	URUACU	06/12/2020 11:06	06/12/2020 12:49	06/12/2020 11:06	06/12/2020 12:49	1,71	12	20,54	CHI
20201225799	LUZIANIA	LZ12041409	RIO VERMELHO	06/12/2020 11:11	06/12/2020 22:27	06/12/2020 11:11	06/12/2020 22:27	11,27	5	56,33	CHI
20201225803	SAO JOAO D ALIANCA	JL21295135	SAO JOAO D ALIANCA	06/12/2020 11:11	07/12/2020 12:18	06/12/2020 11:11	07/12/2020 12:18	25,10	1	25,10	CHI
20201225855	AMARALINA	LC12286013	NOVA CRIXAS	06/12/2020 11:12	07/12/2020 11:21	06/12/2020 11:12	07/12/2020 11:21	24,15	9	217,31	CHI
20201225855	MARA ROSA	LC12286013	NOVA CRIXAS	06/12/2020 11:12	07/12/2020 11:21	06/12/2020 11:12	07/12/2020 11:21	24,15	1	24,15	CHI
20201225817	FLORES DE GOIAS	FB11255063	FLORES DE GOIAS	06/12/2020 11:13	07/12/2020 15:00	06/12/2020 11:13	07/12/2020 15:00	27,77	18	499,85	CHI
20201225827	PORANGATU	PO12145187	PORANGATU	06/12/2020 11:14	07/12/2020 09:49	06/12/2020 11:14	07/12/2020 09:49	22,57	8	180,54	CHI
20201225834	LUZIANIA	LZ21183919	MARAJOARA	06/12/2020 11:15	07/12/2020 01:34	06/12/2020 11:15	07/12/2020 01:34	14,30	2	28,60	CHI
20201226973	PORANGATU	PO21291179	PORANGATU	06/12/2020 11:15	06/12/2020 16:50	06/12/2020 11:15	06/12/2020 16:50	5,58	1	5,58	CHI
20201225838	CRISTALINA	KR21261579	CRISTALINA S2	06/12/2020 11:16	06/12/2020 12:49	06/12/2020 11:16	06/12/2020 12:49	1,53	1	1,53	CHI
20201225859	FORMOSA	10014686315	ITUIQUIRA	06/12/2020 11:20	06/12/2020 20:22	06/12/2020 11:20	06/12/2020 20:22	9,02	1	9,02	CHI
20201225960	FLORES DE GOIAS	FB12164519LD	FLORES DE GOIAS	06/12/2020 11:20	07/12/2020 14:06	07/12/2020 10:11	07/12/2020 12:28	2,29	7	16,06	CHI
20201225960	FORMOSA	FB12106993	FLORES DE GOIAS	06/12/2020 11:20	07/12/2020 14:06	06/12/2020 11:20	07/12/2020 14:06	26,77	99	2649,82	CHI
20201225960	FORMOSA	FB12106993	FLORES DE GOIAS	06/12/2020 11:20	07/12/2020 14:06	06/12/2020 18:52	07/12/2020 14:06	19,24	35	673,32	CHI
20201225960	FLORES DE GOIAS	FB12106993	FLORES DE GOIAS	06/12/2020 11:20	07/12/2020 14:06	06/12/2020 18:52	07/12/2020 14:06	19,24	3	57,71	CHI
20201225960	FORMOSO	FB12106993	FLORES DE GOIAS	06/12/2020 11:20	07/12/2020 14:06	06/12/2020 18:52	07/12/2020 14:06	19,24	1	19,24	CHI
20201225960	SAO JOAO D ALIANCA	FB12106993	FLORES DE GOIAS	06/12/2020 11:20	07/12/2020 14:06	06/12/2020 18:52	07/12/2020 14:06	19,24	5	96,19	CHI
20201225960	FORMOSA	FB12106993	FLORES DE GOIAS	06/12/2020 11:20	07/12/2020 14:06	06/12/2020 18:53	07/12/2020 14:06	19,21	4	76,86	CHI
20201225960	FLORES DE GOIAS	FB12106993	FLORES DE GOIAS	06/12/2020 11:20	07/12/2020 14:06	06/12/2020 18:53	07/12/2020 14:06	19,21	9	172,93	CHI
20201225960	FLORES DE GOIAS	FB12106993	FLORES DE GOIAS	06/12/2020 11:20	07/12/2020 14:06	07/12/2020 10:11	07/12/2020 14:06	3,92	2	7,84	CHI
20201225895	FLORES DE GOIAS	FB21265733	FLORES DE GOIAS	06/12/2020 11:28	07/12/2020 20:35	06/12/2020 11:28	07/12/2020 20:35	33,12	1	33,12	CHI
20201225902	LUZIANIA	LZ21133209	RIO VERMELHO	06/12/2020 11:29	06/12/2020 15:47	06/12/2020 11:29	06/12/2020 15:47	4,30	1	4,30	CHI
20201227039	FORMOSA	FA11000049	ITUIQUIRA	06/12/2020 11:33	06/12/2020 17:18	06/12/2020 11:33	06/12/2020 17:18	5,75	49	281,75	CHI
20201225921	FORMOSA	FA12366183	ITUIQUIRA	06/12/2020 11:34	06/12/2020 17:35	06/12/2020 11:34	06/12/2020 17:35	6,01	1	6,01	CHI
20201225926	FORMOSA	FA12426225	SAO JOAO D ALIANCA	06/12/2020 11:34	06/12/2020 18:29	06/12/2020 11:34	06/12/2020 18:29	6,90	7	48,32	CHI
20201226132	LUZIANIA	LZ12261442	MARAJOARA	06/12/2020 11:35	06/12/2020 20:22	06/12/2020 11:35	06/12/2020 20:22	8,78	4	35,11	CHI
20201225939	FLORES DE GOIAS	IA12361389	IACIARA S2	06/12/2020 11:37	06/12/2020 16:42	06/12/2020 11:37	06/12/2020 16:42	5,07	1	5,07	CHI
20201225939	IACIARA	IA12361389	IACIARA S2	06/12/2020 11:37	06/12/2020 16:42	06/12/2020 11:37	06/12/2020 16:42	5,07	42	212,94	CHI
20201225941	CATALAO	10000078016	CATALAO S2	06/12/2020 11:38	06/12/2020 16:08	06/12/2020 11:38	06/12/2020 16:08	4,50	1	4,50	CHI
20201228230	CROMINIA	CQ12079862	PONTALINA	06/12/2020 11:41	07/12/2020 08:27	06/12/2020 11:41	07/12/2020 08:27	20,76	1	20,76	CHI
20201225989	SAO DOMINGOS	O2090424	SAO DOMINGOS	06/12/2020 11:44	06/12/2020 13:37	06/12/2020 11:44	06/12/2020 12:34	0,83	60	49,50	CHI
20201225989	SAO DOMINGOS	O2090424	SAO DOMINGOS	06/12/2020 11:44	06/12/2020 13:37	06/12/2020 11:44	06/12/2020 13:15	1,51	26	39,30	CHI
20201225989	GUARANI DE GOIAS	O2090424	SAO DOMINGOS	06/12/2020 11:44	06/12/2020 13:37	06/12/2020 11:44	06/12/2020 13:23	1,65	151	249,23	CHI
20201225989	SAO DOMINGOS	O2090424	SAO DOMINGOS	06/12/2020 11:44	06/12/2020 13:37	06/12/2020 11:44	06/12/2020 13:23	1,65	869	1434,33	CHI
20201225989	NOVA ROMA	SD10419131	SAO DOMINGOS	06/12/2020 11:44	06/12/2020 13:37	06/12/2020 11:46	06/12/2020 13:23	1,63	3	4,88	CHI
20201225989	SAO DOMINGOS	SD10419131	SAO DOMINGOS	06/12/2020 11:44	06/12/2020 13:37	06/12/2020 11:46	06/12/2020 13:23	1,63	37	60,17	CHI
20201225989	MONTE ALEGRE DE GOIAS	SD10419131	SAO DOMINGOS	06/12/2020 11:44	06/12/2020 13:37	06/12/2020 11:46	06/12/2020 13:23	1,63	1	1,63	CHI
20201225989	GUARANI DE GOIAS	O2090424	SAO DOMINGOS	06/12/2020 11:44	06/12/2020 13:37	06/12/2020 11:44	06/12/2020 13:37	1,88	2	3,77	CHI
20201225989	SAO DOMINGOS	O2090424	SAO DOMINGOS	06/12/2020 11:44	06/12/2020 13:37	06/12/2020 11:44	06/12/2020 13:37	1,88	203	382,43	CHI
20201225989	SAO DOMINGOS	SD12153745	SAO DOMINGOS	06/12/2020 11:44	06/12/2020 13:37	06/12/2020 11:46	06/12/2020 13:37	1,86	13	24,17	CHI
20201225982	SANTO ANTONIO DO DESCOBERTO	2210109560	AGUAS LINDAS DE GOIAS S2	06/12/2020 11:46	06/12/2020 18:04	06/12/2020 11:46	06/12/2020 18:04	6,29	1	6,29	CHI
20201226233	MUNDO NOVO DE GOIAS	MH12362454	NOVA CRIXAS	06/12/2020 11:49	06/12/2020 19:59	06/12/2020 11:49	06/12/2020 19:59	8,15	301	2454,15	CHI
20201226233	AMARALINA	MH12362454	NOVA CRIXAS	06/12/2020 11:49	06/12/2020 19:59	06/12/2020 11:49	06/12/2020 19:59	8,15	1	8,15	CHI
20201226001	CRISTALINA	KR11273470	CRISTALINA S2	06/12/2020 11:50	06/12/2020 22:12	06/12/2020 11:50	06/12/2020 22:12	10,37	1	10,37	CHI
20201226003	EDEIA	EA12044508	EDEIA	06/12/2020 11:51	06/12/2020 20:14	06/12/2020 11:51	06/12/2020 20:14	8,38	2	16,76	CHI

20201226017	CAMPOS BELOS	7270001880	SAO DOMINGOS	06/12/2020 11:52	06/12/2020 14:18	06/12/2020 11:52	06/12/2020 14:18	2,42	1	2,42	CHI
20201226738	MUTUNOPOLIS	PO12038770	PORANGATU	06/12/2020 11:52	07/12/2020 05:22	06/12/2020 11:52	07/12/2020 05:22	17,49	1	17,49	CHI
20201226738	PORANGATU	PO12038770	PORANGATU	06/12/2020 11:52	07/12/2020 05:22	06/12/2020 11:52	07/12/2020 05:22	17,49	15	262,34	CHI
20201227466	SAO MIGUEL DO ARAGUAIA	SM12143671	SAO MIGUEL DO ARAGUAIA	06/12/2020 11:52	07/12/2020 11:38	06/12/2020 11:52	07/12/2020 11:38	23,76	276	6557,76	CHI
20201226039	MAIRIPOTABA	MI21264737	PONTALINA	06/12/2020 11:55	06/12/2020 15:15	06/12/2020 11:55	06/12/2020 15:15	3,32	2	6,64	CHI
20201226054	GUARINOS	GF12237440	SANTA TEREZINHA	06/12/2020 11:59	06/12/2020 22:02	06/12/2020 11:59	06/12/2020 22:02	10,05	11	110,50	CHI
20201226090	MARA ROSA	MQ16407727	MARA ROSA	06/12/2020 12:00	06/12/2020 14:16	06/12/2020 12:00	06/12/2020 14:14	2,23	401	896,23	CHI
20201226090	CAMPINORTE	MQ16407727	MARA ROSA	06/12/2020 12:00	06/12/2020 14:16	06/12/2020 12:00	06/12/2020 14:16	2,27	12	27,23	CHI
20201226090	MARA ROSA	MQ16407727	MARA ROSA	06/12/2020 12:00	06/12/2020 14:16	06/12/2020 12:00	06/12/2020 14:16	2,27	695	1576,88	CHI
20201226090	ESTRELA DO NORTE	MQ16407727	MARA ROSA	06/12/2020 12:00	06/12/2020 14:16	06/12/2020 12:00	06/12/2020 14:16	2,27	7	15,88	CHI
20201226460	PORANGATU	PO12028736	PORANGATU	06/12/2020 12:00	07/12/2020 04:48	06/12/2020 12:00	07/12/2020 04:48	16,80	4	67,19	CHI
20201226115	NOVA GLORIA	O1950214	ITAPACI	06/12/2020 12:02	06/12/2020 20:09	06/12/2020 12:02	06/12/2020 19:44	7,71	1	7,71	CHI
20201226115	NOVA GLORIA	O1950214	ITAPACI	06/12/2020 12:02	06/12/2020 20:09	06/12/2020 12:02	06/12/2020 20:09	8,12	1	8,12	CHI
20201226115	ITAPACI	O1950214	ITAPACI	06/12/2020 12:02	06/12/2020 20:09	06/12/2020 12:02	06/12/2020 20:09	8,12	171	1389,33	CHI
20201226115	GUARINOS	O1950214	ITAPACI	06/12/2020 12:02	06/12/2020 20:09	06/12/2020 12:02	06/12/2020 20:09	8,12	19	154,37	CHI
20201226115	ITAPACI	O1950214	ITAPACI	06/12/2020 12:02	06/12/2020 20:09	06/12/2020 12:04	06/12/2020 20:09	8,09	7	56,65	CHI
20201226115	GUARINOS	O1950214	ITAPACI	06/12/2020 12:02	06/12/2020 20:09	06/12/2020 12:04	06/12/2020 20:09	8,09	1	8,09	CHI
20201226122	BALIZA	BH12356619	BOM JARDIM	06/12/2020 12:04	06/12/2020 17:29	06/12/2020 12:04	06/12/2020 17:29	5,41	14	75,75	CHI
20201226076	CRIXAS	CX12268893	SERRA DO OURO	06/12/2020 12:05	07/12/2020 09:01	06/12/2020 12:05	07/12/2020 09:01	20,92	1	20,92	CHI
20201226717	PORANGATU	PO12391912	PORANGATU	06/12/2020 12:05	07/12/2020 02:32	06/12/2020 12:05	07/12/2020 02:32	14,43	99	1429,04	CHI
20201226717	MUTUNOPOLIS	PO12391912	PORANGATU	06/12/2020 12:05	07/12/2020 02:32	06/12/2020 12:05	07/12/2020 02:32	14,43	38	548,52	CHI
20201226229	ALTO PARAISO DE GOIAS	BF12180774	FLORES DE GOIAS	06/12/2020 12:06	06/12/2020 16:51	06/12/2020 12:06	06/12/2020 16:51	4,74	13	61,57	CHI
20201226435	GOIAS	GS12250574	GOIAS	06/12/2020 12:06	06/12/2020 15:29	06/12/2020 12:06	06/12/2020 15:29	3,37	8	26,97	CHI
20201226085	FORMOSA	FA21361248	ITUIQUIRA	06/12/2020 12:07	06/12/2020 16:34	06/12/2020 12:07	06/12/2020 16:34	4,45	1	4,45	CHI
20201226089	ALEXANIA	AX31135872	ALEXANIA	06/12/2020 12:07	06/12/2020 15:28	06/12/2020 12:07	06/12/2020 15:28	3,34	1	3,34	CHI
20201226092	PORANGATU	PO21136928	PORANGATU	06/12/2020 12:08	07/12/2020 09:43	06/12/2020 12:08	07/12/2020 09:43	21,57	1	21,57	CHI
20201226093	LUZIANIA	LZ21116036	MARAJOARA	06/12/2020 12:08	06/12/2020 18:14	06/12/2020 12:08	06/12/2020 18:14	6,09	2	12,17	CHI
20201226509	PADRE BERNARDO	ZN12089830	COCALZINHO	06/12/2020 12:13	06/12/2020 17:39	06/12/2020 12:13	06/12/2020 17:39	5,43	1	5,43	CHI
20201226509	COCALZINHO DE GOIAS	ZN12089830	COCALZINHO	06/12/2020 12:13	06/12/2020 17:39	06/12/2020 12:13	06/12/2020 17:39	5,43	10	54,33	CHI
20201226514	FORMOSO	FO12143711RE	MARA ROSA	06/12/2020 12:14	06/12/2020 18:35	06/12/2020 12:14	06/12/2020 18:35	6,34	23	145,83	CHI
20201226131	PORANGATU	PO12390257	PORANGATU	06/12/2020 12:17	06/12/2020 12:41	06/12/2020 12:17	06/12/2020 12:41	0,39	4	1,56	CHI
20201226152	CAVALCANTE	CJ12063197	FLORES DE GOIAS	06/12/2020 12:21	07/12/2020 08:50	06/12/2020 12:21	07/12/2020 08:50	20,47	1	20,47	CHI
20201226212	CUMARI	CY12000313	CATALAO S1	06/12/2020 12:21	06/12/2020 18:00	06/12/2020 12:21	06/12/2020 18:00	5,64	22	124,01	CHI
20201226156	EDEALINA	ED21218137	PONTALINA	06/12/2020 12:22	06/12/2020 16:59	06/12/2020 12:22	06/12/2020 16:59	4,61	1	4,61	CHI
20201228328	ALEXANIA	AX12377762RE	ALEXANIA	06/12/2020 12:24	06/12/2020 19:30	06/12/2020 12:24	06/12/2020 19:30	7,09	34	240,99	CHI
20201228328	CORUMBA DE GOIAS	AX12377762RE	ALEXANIA	06/12/2020 12:24	06/12/2020 19:30	06/12/2020 12:24	06/12/2020 19:30	7,09	2	14,18	CHI
20201226173	GOIAS	GS11162299	GOIAS	06/12/2020 12:25	06/12/2020 21:06	06/12/2020 12:25	06/12/2020 21:06	8,67	2	17,34	CHI
20201226185	SANCLERLANDIA	SC12004777	FIRMINOPOLIS S2	06/12/2020 12:28	06/12/2020 16:12	06/12/2020 12:28	06/12/2020 16:12	3,72	2	7,45	CHI
20201226230	CAVALCANTE	CJ12286408	MINACU	06/12/2020 12:30	06/12/2020 19:23	06/12/2020 12:30	06/12/2020 19:23	6,88	9	61,92	CHI
20201226194	NOVA ROMA	ND12161820RE	IACIARA S2	06/12/2020 12:31	06/12/2020 19:44	06/12/2020 12:31	06/12/2020 19:44	7,21	132	951,46	CHI
20201226294	INDIARA	ED12293192	PONTALINA	06/12/2020 12:31	06/12/2020 16:19	06/12/2020 12:31	06/12/2020 16:19	3,79	2	7,57	CHI
20201226294	EDEALINA	ED12293192	PONTALINA	06/12/2020 12:31	06/12/2020 16:19	06/12/2020 12:31	06/12/2020 16:19	3,79	18	68,15	CHI
20201226201	SANTA CRUZ DE GOIAS	CN12409036	CALDAS NOVAS S1	06/12/2020 12:34	06/12/2020 14:38	06/12/2020 12:34	06/12/2020 14:38	2,07	4	8,26	CHI
20201226202	CORUMBA DE GOIAS	CB12311983	CORUMBA	06/12/2020 12:34	06/12/2020 13:12	06/12/2020 12:34	06/12/2020 13:12	0,63	1	0,63	CHI
20201226205	MIMOSO DE GOIAS	10025846874	PADRE BERNARDO	06/12/2020 12:34	06/12/2020 17:13	06/12/2020 12:34	06/12/2020 17:13	4,64	1	4,64	CHI
20201226552	PARAUNA	EU12044261	ACREUNA	06/12/2020 12:35	06/12/2020 16:38	06/12/2020 12:35	06/12/2020 16:38	4,04	10	40,38	CHI
20201226219	PORANGATU	PO21315429	NOVO PLANALTO	06/12/2020 12:38	07/12/2020 11:07	06/12/2020 12:38	07/12/2020 11:07	22,47	1	22,47	CHI
20201226231	ITUMBIARA	IT11122251	ITUMBIARA VELHA S1	06/12/2020 12:40	06/12/2020 17:00	06/12/2020 12:40	06/12/2020 17:00	4,32	1	4,32	CHI
20201226232	POSSE	PS21232249	IACIARA S2	06/12/2020 12:40	06/12/2020 15:16	06/12/2020 12:40	06/12/2020 15:16	2,59	1	2,59	CHI
20201226254	MORRINHOS	MR10406908	MORRINHOS	06/12/2020 12:40	07/12/2020 19:46	06/12/2020 17:27	06/12/2020 17:39	0,20	4	0,81	CHI
20201226254	MORRINHOS	MR12040540RE	MORRINHOS	06/12/2020 12:40	07/12/2020 19:46	06/12/2020 12:40	06/12/2020 19:35	6,93	13	90,07	CHI

20201226254	MORRINHOS	MR10406908	MORRINHOS	06/12/2020 12:40	07/12/2020 19:46	06/12/2020 21:44	06/12/2020 22:28	0,73	38	27,88	CHI
20201226254	MORRINHOS	MR10406908	MORRINHOS	06/12/2020 12:40	07/12/2020 19:46	07/12/2020 13:35	07/12/2020 14:04	0,48	57	27,23	CHI
20201226254	MORRINHOS	MR12182765LD	MORRINHOS	06/12/2020 12:40	07/12/2020 19:46	06/12/2020 12:40	07/12/2020 19:07	30,46	11	335,09	CHI
20201226254	IPAMERI	MR12093241	MORRINHOS	06/12/2020 12:40	07/12/2020 19:46	06/12/2020 12:40	07/12/2020 19:09	30,49	1	30,49	CHI
20201226254	MORRINHOS	MR12093241	MORRINHOS	06/12/2020 12:40	07/12/2020 19:46	06/12/2020 12:40	07/12/2020 19:09	30,49	7	213,41	CHI
20201226254	MORRINHOS	MR12182765LD	MORRINHOS	06/12/2020 12:40	07/12/2020 19:46	06/12/2020 12:40	07/12/2020 19:39	30,99	1	30,99	CHI
20201226254	MORRINHOS	MR12128657	MORRINHOS	06/12/2020 12:40	07/12/2020 19:46	06/12/2020 12:40	07/12/2020 19:46	31,10	2	62,20	CHI
20201226239	NOVA CRIXAS	NA11055778	NOVA CRIXAS	06/12/2020 12:42	06/12/2020 17:28	06/12/2020 12:42	06/12/2020 17:28	4,76	69	328,36	CHI
20201226247	ANAPOLIS	20623008	ANAPOLIS UNIVERSITARIO S2	06/12/2020 12:43	06/12/2020 15:34	06/12/2020 12:43	06/12/2020 15:34	2,85	1	2,85	CHI
20201226255	JOVIANIA	JV12050247	VICENTINOPOLIS	06/12/2020 12:45	06/12/2020 23:08	06/12/2020 12:45	06/12/2020 23:08	10,38	8	83,04	CHI
20201226971	MUNDO NOVO DE GOIAS	MH11255525	NOVA CRIXAS	06/12/2020 12:45	06/12/2020 17:44	06/12/2020 12:45	06/12/2020 17:44	4,98	84	418,48	CHI
20201226554	NOVA IGUACU DE GOIAS	MQ12146959	MARA ROSA	06/12/2020 12:46	06/12/2020 16:55	06/12/2020 12:46	06/12/2020 16:55	4,15	12	49,78	CHI
20201226554	MARA ROSA	MQ12146959	MARA ROSA	06/12/2020 12:46	06/12/2020 16:55	06/12/2020 12:46	06/12/2020 16:55	4,15	11	45,63	CHI
20201226656	NOVA CRIXAS	NA12318473	NOVA CRIXAS	06/12/2020 12:46	06/12/2020 16:48	06/12/2020 12:46	06/12/2020 16:48	4,03	58	233,95	CHI
20201226269	RIO VERDE	ML12279537	SANTA HELENA S1	06/12/2020 12:47	06/12/2020 16:10	06/12/2020 12:47	06/12/2020 16:10	3,37	2	6,75	CHI
20201226576	SANTA HELENA DE GOIAS	SH12033707	IPEGUARI	06/12/2020 12:49	06/12/2020 17:32	06/12/2020 12:49	06/12/2020 17:32	4,71	2	9,41	CHI
20201226684	MINEIROS	MY12209755	PARQUE DAS EMAS	06/12/2020 12:49	07/12/2020 14:40	06/12/2020 12:49	06/12/2020 19:34	6,75	10	67,48	CHI
20201226684	MINEIROS	MY12209755	PARQUE DAS EMAS	06/12/2020 12:49	07/12/2020 14:40	06/12/2020 12:49	07/12/2020 10:55	22,09	2	44,17	CHI
20201226684	MINEIROS	MY12209755	PARQUE DAS EMAS	06/12/2020 12:49	07/12/2020 14:40	06/12/2020 12:49	07/12/2020 14:40	25,83	5	129,17	CHI
20201226279	MOSSAMEDES	MD12005317	FIRMINOPOLIS S2	06/12/2020 12:50	07/12/2020 01:22	06/12/2020 12:50	07/12/2020 01:22	12,52	16	200,34	CHI
20201226280	PORANGATU	PO21230421	PORANGATU	06/12/2020 12:51	07/12/2020 09:37	06/12/2020 12:51	07/12/2020 09:37	20,77	1	20,77	CHI
20201226282	JOVIANIA	VI12218198RE	VICENTINOPOLIS	06/12/2020 12:51	06/12/2020 23:08	06/12/2020 12:51	06/12/2020 23:08	10,28	20	205,56	CHI
20201226282	VICENTINOPOLIS	VI12218198RE	VICENTINOPOLIS	06/12/2020 12:51	06/12/2020 23:08	06/12/2020 12:51	06/12/2020 23:08	10,28	16	164,44	CHI
20201226287	MINACU	4020008475	MINACU	06/12/2020 12:51	07/12/2020 10:01	06/12/2020 12:51	07/12/2020 10:01	21,15	1	21,15	CHI
20201226342	GOIAS	GS12310766	GOIAS	06/12/2020 12:53	06/12/2020 16:56	06/12/2020 12:53	06/12/2020 16:56	4,04	17	68,69	CHI
20201226304	NOVA CRIXAS	NA21388756	NOVA CRIXAS	06/12/2020 12:54	06/12/2020 18:27	06/12/2020 12:54	06/12/2020 18:27	5,54	1	5,54	CHI
20201226316	NOVA CRIXAS	NA12091693	NOVA CRIXAS	06/12/2020 12:55	06/12/2020 17:44	06/12/2020 12:55	06/12/2020 17:44	4,81	2	9,63	CHI
20201229159	PORANGATU	PO12079340	PORANGATU	06/12/2020 12:56	07/12/2020 19:21	06/12/2020 12:56	07/12/2020 19:21	30,40	6	182,40	CHI
20201226330	MARA ROSA	MQ12051834	MARA ROSA	06/12/2020 12:58	06/12/2020 20:19	06/12/2020 12:58	06/12/2020 20:19	7,34	13	95,41	CHI
20201226332	PIRENOPOLIS	JA12059976	JARAGUA	06/12/2020 13:00	06/12/2020 19:38	06/12/2020 13:00	06/12/2020 19:38	6,64	97	643,60	CHI
20201226332	JARAGUA	JA12059976	JARAGUA	06/12/2020 13:00	06/12/2020 19:38	06/12/2020 13:00	06/12/2020 19:38	6,64	2	13,27	CHI
20201226337	QUIRINOPOLIS	QI21113286	QUIRINOPOLIS	06/12/2020 13:00	06/12/2020 15:11	06/12/2020 13:00	06/12/2020 15:11	2,17	2	4,35	CHI
20201226340	RIO VERDE	10028108254	RIO VERDE S1	06/12/2020 13:00	06/12/2020 17:57	06/12/2020 13:00	06/12/2020 17:57	4,95	1	4,95	CHI
20201226461	LUZIANIA	LZ11000075	RIO VERMELHO	06/12/2020 13:00	06/12/2020 15:30	06/12/2020 13:00	06/12/2020 15:30	2,50	60	149,73	CHI
20201227172	SAO JOAO D ALIANCA	FB12254528	FLORES DE GOIAS	06/12/2020 13:00	08/12/2020 15:29	06/12/2020 13:00	08/12/2020 15:29	50,47	7	353,31	CHI
20201227172	FLORES DE GOIAS	FB12254528	FLORES DE GOIAS	06/12/2020 13:00	08/12/2020 15:29	06/12/2020 13:00	08/12/2020 15:29	50,47	6	302,84	CHI
20201226386	ITABERAI	IB12210550	ITABERAI S1	06/12/2020 13:01	06/12/2020 14:43	06/12/2020 13:01	06/12/2020 14:43	1,69	9	15,18	CHI
20201226349	SANTO ANTONIO DO DESCOBERTO	2900094830	MARAJOARA	06/12/2020 13:03	06/12/2020 16:54	06/12/2020 13:03	06/12/2020 16:54	3,85	1	3,85	CHI
20201226709	MARA ROSA	MQ12028228	MARA ROSA	06/12/2020 13:03	06/12/2020 18:19	06/12/2020 13:03	06/12/2020 18:19	5,25	16	84,01	CHI
20201226357	GOIAS	GS12037486	ITABERAI S1	06/12/2020 13:05	06/12/2020 19:34	06/12/2020 13:05	06/12/2020 19:34	6,48	20	129,52	CHI
20201226361	TRINDADE	40191953	TRINDADE	06/12/2020 13:05	06/12/2020 14:06	06/12/2020 13:05	06/12/2020 14:06	1,00	1	1,00	CHI
20201226365	MINEIROS	MY12390605RE	PARQUE DAS EMAS	06/12/2020 13:06	06/12/2020 15:43	06/12/2020 13:06	06/12/2020 15:43	2,60	15	39,05	CHI
20201226369	GOIANIA	15755654	REAL S2	06/12/2020 13:07	06/12/2020 15:36	06/12/2020 13:07	06/12/2020 15:36	2,47	1	2,47	CHI
20201226370	QUIRINOPOLIS	QI12279630	QUIRINOPOLIS	06/12/2020 13:08	06/12/2020 16:51	06/12/2020 13:08	06/12/2020 16:51	3,71	4	14,85	CHI
20201226573	NOVA CRIXAS	NA12158759	NOVA CRIXAS	06/12/2020 13:08	06/12/2020 17:53	06/12/2020 13:08	06/12/2020 17:53	4,74	60	284,60	CHI
20201228180	NOVA CRIXAS	NA11201787	NOVA CRIXAS	06/12/2020 13:08	06/12/2020 20:11	06/12/2020 13:08	06/12/2020 20:11	7,04	126	887,46	CHI
20201226374	APARECIDA DE GOIANIA	10026525443	ATLANTICO S1	06/12/2020 13:09	06/12/2020 17:41	06/12/2020 13:09	06/12/2020 17:41	4,53	1	4,53	CHI
20201226378	QUIRINOPOLIS	QI21326636	QUIRINOPOLIS	06/12/2020 13:10	06/12/2020 15:52	06/12/2020 13:10	06/12/2020 15:52	2,70	1	2,70	CHI
20201226383	SANTO ANTONIO DO DESCOBERTO	2210020548	AGUAS LINDAS DE GOIAS S2	06/12/2020 13:11	06/12/2020 15:43	06/12/2020 13:11	06/12/2020 15:43	2,53	1	2,53	CHI
20201226385	LUZIANIA	LZ21344830	MARAJOARA	06/12/2020 13:11	06/12/2020 15:39	06/12/2020 13:11	06/12/2020 15:39	2,46	1	2,46	CHI
20201226404	PARAUNA	05760414	PARAUNA	06/12/2020 13:11	08/12/2020 22:54	06/12/2020 13:11	06/12/2020 15:34	2,38	80	190,09	CHI

20201226404	JANDAIA	05760414	PARAUNA	06/12/2020 13:11	08/12/2020 22:54	06/12/2020 13:11	06/12/2020 15:34	2,38	3	7,13	CHI
20201226404	JANDAIA	05760414	PARAUNA	06/12/2020 13:11	08/12/2020 22:54	06/12/2020 17:14	06/12/2020 17:17	0,05	3	0,15	CHI
20201226404	PARAUNA	05760414	PARAUNA	06/12/2020 13:11	08/12/2020 22:54	06/12/2020 17:14	06/12/2020 17:17	0,05	82	4,12	CHI
20201226404	PARAUNA	05760414	PARAUNA	06/12/2020 13:11	08/12/2020 22:54	06/12/2020 22:06	06/12/2020 22:36	0,50	82	41,36	CHI
20201226404	JANDAIA	05760414	PARAUNA	06/12/2020 13:11	08/12/2020 22:54	06/12/2020 22:06	06/12/2020 22:36	0,50	3	1,51	CHI
20201226404	MONTIVIDIU	RV10400619	MONTIVIDIU T	06/12/2020 13:11	08/12/2020 22:54	07/12/2020 01:40	07/12/2020 02:10	0,50	33	16,46	CHI
20201226404	PARAUNA	RV10400619	MONTIVIDIU T	06/12/2020 13:11	08/12/2020 22:54	07/12/2020 01:40	07/12/2020 02:10	0,50	102	50,89	CHI
20201226404	IVOLANDIA	RV10400619	MONTIVIDIU T	06/12/2020 13:11	08/12/2020 22:54	07/12/2020 01:40	07/12/2020 02:10	0,50	7	3,49	CHI
20201226404	CAIAPONIA	RV10400619	MONTIVIDIU T	06/12/2020 13:11	08/12/2020 22:54	07/12/2020 01:40	07/12/2020 02:10	0,50	27	13,47	CHI
20201226404	RIO VERDE	RV10400619	MONTIVIDIU T	06/12/2020 13:11	08/12/2020 22:54	07/12/2020 01:40	07/12/2020 02:10	0,50	124	61,86	CHI
20201226404	JANDAIA	05760414	PARAUNA	06/12/2020 13:11	08/12/2020 22:54	07/12/2020 14:38	07/12/2020 14:53	0,25	3	0,75	CHI
20201226404	PARAUNA	05760414	PARAUNA	06/12/2020 13:11	08/12/2020 22:54	07/12/2020 14:38	07/12/2020 14:53	0,25	82	20,50	CHI
20201226404	PARAUNA	PU13206097	PARAUNA	06/12/2020 13:11	08/12/2020 22:54	06/12/2020 13:11	07/12/2020 16:15	27,05	3	81,16	CHI
20201226404	RIO VERDE	RV12289713LD	PARAUNA	06/12/2020 13:11	08/12/2020 22:54	06/12/2020 13:11	07/12/2020 16:40	27,47	2	54,94	CHI
20201226404	PARAUNA	RV12289713LD	PARAUNA	06/12/2020 13:11	08/12/2020 22:54	06/12/2020 13:11	07/12/2020 16:40	27,47	148	4065,60	CHI
20201226404	RIO VERDE	RV12289713LD	MONTIVIDIU T	06/12/2020 13:11	08/12/2020 22:54	06/12/2020 13:11	07/12/2020 16:40	27,47	13	357,11	CHI
20201226404	PARAUNA	RV10400619	PARAUNA	06/12/2020 13:11	08/12/2020 22:54	07/12/2020 17:41	07/12/2020 17:44	0,05	150	8,17	CHI
20201226404	RIO VERDE	RV10400619	MONTIVIDIU T	06/12/2020 13:11	08/12/2020 22:54	07/12/2020 17:41	07/12/2020 17:44	0,05	137	7,46	CHI
20201226404	CAIAPONIA	RV10400619	MONTIVIDIU T	06/12/2020 13:11	08/12/2020 22:54	07/12/2020 17:41	07/12/2020 17:44	0,05	39	2,12	CHI
20201226404	PARAUNA	RV10400619	MONTIVIDIU T	06/12/2020 13:11	08/12/2020 22:54	07/12/2020 17:41	07/12/2020 17:44	0,05	147	8,00	CHI
20201226404	RIO VERDE	RV10400619	PARAUNA	06/12/2020 13:11	08/12/2020 22:54	07/12/2020 17:41	07/12/2020 17:44	0,05	2	0,11	CHI
20201226404	MONTIVIDIU	RV10400619	MONTIVIDIU T	06/12/2020 13:11	08/12/2020 22:54	07/12/2020 17:41	07/12/2020 17:44	0,05	36	1,96	CHI
20201226404	IVOLANDIA	RV10400619	MONTIVIDIU T	06/12/2020 13:11	08/12/2020 22:54	07/12/2020 17:41	07/12/2020 17:44	0,05	29	1,58	CHI
20201226404	RIO VERDE	RV10400619	MONTIVIDIU T	06/12/2020 13:11	08/12/2020 22:54	07/12/2020 17:45	07/12/2020 18:02	0,28	124	34,20	CHI
20201226404	IVOLANDIA	RV10400619	MONTIVIDIU T	06/12/2020 13:11	08/12/2020 22:54	07/12/2020 17:45	07/12/2020 18:02	0,28	29	8,00	CHI
20201226404	CAIAPONIA	RV10400619	MONTIVIDIU T	06/12/2020 13:11	08/12/2020 22:54	07/12/2020 17:45	07/12/2020 18:02	0,28	39	10,76	CHI
20201226404	MONTIVIDIU	RV10400619	MONTIVIDIU T	06/12/2020 13:11	08/12/2020 22:54	07/12/2020 17:45	07/12/2020 18:02	0,28	36	9,93	CHI
20201226404	PARAUNA	RV10400619	MONTIVIDIU T	06/12/2020 13:11	08/12/2020 22:54	07/12/2020 17:45	07/12/2020 18:02	0,28	147	40,55	CHI
20201226404	PARAUNA	MV10400640	MONTIVIDIU T	06/12/2020 13:11	08/12/2020 22:54	07/12/2020 22:13	07/12/2020 22:28	0,25	90	22,63	CHI
20201226404	RIO VERDE	MV10400640	MONTIVIDIU T	06/12/2020 13:11	08/12/2020 22:54	07/12/2020 22:13	07/12/2020 22:28	0,25	1	0,25	CHI
20201226404	IVOLANDIA	MV10400640	MONTIVIDIU T	06/12/2020 13:11	08/12/2020 22:54	07/12/2020 22:13	07/12/2020 22:28	0,25	29	7,29	CHI
20201226404	CAIAPONIA	MV10400640	MONTIVIDIU T	06/12/2020 13:11	08/12/2020 22:54	07/12/2020 22:13	07/12/2020 22:28	0,25	39	9,80	CHI
20201226404	MONTIVIDIU	MV10400640	MONTIVIDIU T	06/12/2020 13:11	08/12/2020 22:54	07/12/2020 22:13	07/12/2020 22:28	0,25	36	9,05	CHI
20201226404	CAIAPONIA	MV10400640	MONTIVIDIU T	06/12/2020 13:11	08/12/2020 22:54	07/12/2020 22:20	07/12/2020 22:28	0,13	97	12,72	CHI
20201226404	RIO VERDE	MV10400640	MONTIVIDIU T	06/12/2020 13:11	08/12/2020 22:54	07/12/2020 22:20	07/12/2020 22:28	0,13	47	6,16	CHI
20201226404	MONTIVIDIU	MV10400640	MONTIVIDIU T	06/12/2020 13:11	08/12/2020 22:54	07/12/2020 22:20	07/12/2020 22:28	0,13	55	7,21	CHI
20201226404	PARAUNA	PU10400639	MONTIVIDIU T	06/12/2020 13:11	08/12/2020 22:54	07/12/2020 22:33	07/12/2020 22:46	0,22	59	13,19	CHI
20201226404	RIO VERDE	PU10400639	MONTIVIDIU T	06/12/2020 13:11	08/12/2020 22:54	07/12/2020 22:33	07/12/2020 22:46	0,22	113	25,27	CHI
20201226404	PARAUNA	MV10400640	MONTIVIDIU T	06/12/2020 13:11	08/12/2020 22:54	07/12/2020 22:52	07/12/2020 22:57	0,08	149	12,17	CHI
20201226404	MONTIVIDIU	MV10400640	MONTIVIDIU T	06/12/2020 13:11	08/12/2020 22:54	07/12/2020 22:52	07/12/2020 22:57	0,08	91	7,43	CHI
20201226404	IVOLANDIA	MV10400640	MONTIVIDIU T	06/12/2020 13:11	08/12/2020 22:54	07/12/2020 22:52	07/12/2020 22:57	0,08	29	2,37	CHI
20201226404	RIO VERDE	MV10400640	MONTIVIDIU T	06/12/2020 13:11	08/12/2020 22:54	07/12/2020 22:52	07/12/2020 22:57	0,08	161	13,15	CHI
20201226404	CAIAPONIA	MV10400640	MONTIVIDIU T	06/12/2020 13:11	08/12/2020 22:54	07/12/2020 22:52	07/12/2020 22:57	0,08	136	11,11	CHI
20201226404	RIO VERDE	MV10400640	MONTIVIDIU T	06/12/2020 13:11	08/12/2020 22:54	07/12/2020 23:05	08/12/2020 01:07	2,03	6	12,18	CHI
20201226404	RIO VERDE	RV10400619	PARAUNA	06/12/2020 13:11	08/12/2020 22:54	07/12/2020 17:45	08/12/2020 03:45	10,00	2	20,01	CHI
20201226404	RIO VERDE	RV10400619	MONTIVIDIU T	06/12/2020 13:11	08/12/2020 22:54	07/12/2020 17:45	08/12/2020 03:45	10,00	13	130,06	CHI
20201226404	PARAUNA	RV10400619	PARAUNA	06/12/2020 13:11	08/12/2020 22:54	07/12/2020 17:45	08/12/2020 03:45	10,00	150	1500,71	CHI
20201226404	RIO VERDE	RV10400619	MONTIVIDIU T	06/12/2020 13:11	08/12/2020 22:54	07/12/2020 22:33	08/12/2020 03:45	5,21	10	52,11	CHI
20201226404	PARAUNA	RV10400619	MONTIVIDIU T	06/12/2020 13:11	08/12/2020 22:54	07/12/2020 22:33	08/12/2020 03:45	5,21	2	10,42	CHI
20201226404	CAIAPONIA	MV10400640	MONTIVIDIU T	06/12/2020 13:11	08/12/2020 22:54	07/12/2020 23:04	08/12/2020 04:52	5,79	39	225,85	CHI
20201226404	RIO VERDE	MV10400640	MONTIVIDIU T	06/12/2020 13:11	08/12/2020 22:54	07/12/2020 23:04	08/12/2020 04:52	5,79	114	660,19	CHI

20201226404	MONTIVIDIU	MV10400640	MONTIVIDIU T	06/12/2020 13:11	08/12/2020 22:54	07/12/2020 23:04	08/12/2020 04:52	5,79	36	208,48	CHI
20201226404	PARAUNA	MV10400640	MONTIVIDIU T	06/12/2020 13:11	08/12/2020 22:54	07/12/2020 23:04	08/12/2020 04:52	5,79	149	862,88	CHI
20201226404	IVOLANDIA	MV10400640	MONTIVIDIU T	06/12/2020 13:11	08/12/2020 22:54	07/12/2020 23:04	08/12/2020 04:52	5,79	29	167,94	CHI
20201226404	MONTIVIDIU	MV10400640	MONTIVIDIU T	06/12/2020 13:11	08/12/2020 22:54	07/12/2020 23:05	08/12/2020 08:58	9,89	41	405,38	CHI
20201226404	CAIAPONIA	MV10400640	MONTIVIDIU T	06/12/2020 13:11	08/12/2020 22:54	07/12/2020 23:05	08/12/2020 08:58	9,89	6	59,32	CHI
20201226404	RIO VERDE	MV10400640	MONTIVIDIU T	06/12/2020 13:11	08/12/2020 22:54	07/12/2020 23:05	08/12/2020 08:58	9,89	41	405,38	CHI
20201226404	MONTIVIDIU	MV10400640	MONTIVIDIU T	06/12/2020 13:11	08/12/2020 22:54	07/12/2020 23:05	08/12/2020 11:40	12,57	14	176,04	CHI
20201226404	CAIAPONIA	MV10400640	MONTIVIDIU T	06/12/2020 13:11	08/12/2020 22:54	07/12/2020 23:05	08/12/2020 12:47	13,69	91	1246,02	CHI
20201226404	PARAUNA	PU13206097	PARAUNA	06/12/2020 13:11	08/12/2020 22:54	06/12/2020 13:11	08/12/2020 22:54	57,71	5	288,57	CHI
20201226889	SAO MIGUEL DO ARAGUAIA	SM12192361	SAO MIGUEL DO ARAGUAIA	06/12/2020 13:12	07/12/2020 20:09	06/12/2020 13:12	07/12/2020 00:27	11,26	9	101,33	CHI
20201226889	SAO MIGUEL DO ARAGUAIA	SM12192361	SAO MIGUEL DO ARAGUAIA	06/12/2020 13:12	07/12/2020 20:09	06/12/2020 13:12	07/12/2020 18:52	29,67	63	1869,26	CHI
20201226889	SAO MIGUEL DO ARAGUAIA	SM12192361	SAO MIGUEL DO ARAGUAIA	06/12/2020 13:12	07/12/2020 20:09	06/12/2020 13:12	07/12/2020 19:30	30,30	35	1060,59	CHI
20201226889	SAO MIGUEL DO ARAGUAIA	SM12192361	SAO MIGUEL DO ARAGUAIA	06/12/2020 13:12	07/12/2020 20:09	06/12/2020 13:12	07/12/2020 20:09	30,95	61	1887,90	CHI
20201226407	CAMPOS VERDES	VD16407566	SANTA TEREZINHA	06/12/2020 13:13	06/12/2020 22:32	06/12/2020 13:22	06/12/2020 17:48	4,44	158	700,86	CHI
20201226407	CAMPOS VERDES	VD21133342	SANTA TEREZINHA	06/12/2020 13:13	06/12/2020 22:32	06/12/2020 18:48	06/12/2020 22:32	3,73	1	3,73	CHI
20201226396	APORE	AE12000051	ITAJA S1	06/12/2020 13:14	06/12/2020 15:46	06/12/2020 13:14	06/12/2020 15:46	2,53	7	17,68	CHI
20201226398	QUIRINOPOLIS	QI21119903	QUIRINOPOLIS	06/12/2020 13:14	06/12/2020 15:39	06/12/2020 13:14	06/12/2020 15:39	2,40	1	2,40	CHI
20201226401	FAINA	FC21268685	GOIAS	06/12/2020 13:14	06/12/2020 14:53	06/12/2020 13:14	06/12/2020 14:53	1,63	1	1,63	CHI
20201226426	CRISTALINA	KR123206686	CRISTALINA S2	06/12/2020 13:14	06/12/2020 18:18	06/12/2020 13:14	06/12/2020 18:18	5,05	7	35,37	CHI
20201226426	LUZIANIA	KR123206686	CRISTALINA S2	06/12/2020 13:14	06/12/2020 18:18	06/12/2020 13:14	06/12/2020 18:18	5,05	7	35,37	CHI
20201226410	MUNDO NOVO DE GOIAS	MH12035583	NOVA CRIXAS	06/12/2020 13:16	06/12/2020 22:49	06/12/2020 13:16	06/12/2020 22:49	9,54	59	562,94	CHI
20201226412	RIO VERDE	630088445	RIO VERDE S2	06/12/2020 13:17	06/12/2020 19:51	06/12/2020 13:17	06/12/2020 19:51	6,56	1	6,56	CHI
20201226434	CRISTALINA	KR13401743	CRISTALINA S1	06/12/2020 13:17	07/12/2020 18:39	06/12/2020 13:19	06/12/2020 14:44	1,43	166	236,64	CHI
20201226434	CRISTALINA	KR10413340	CRISTALINA S1	06/12/2020 13:17	07/12/2020 18:39	06/12/2020 13:17	07/12/2020 18:39	29,38	23	675,67	CHI
2020120600157	CRISTALINA	03470424	CRISTALINA S1	06/12/2020 13:17	06/12/2020 13:21	06/12/2020 13:17	06/12/2020 13:21	0,07	14	0,93	CHI
20201226414	SANTA ROSA DE GOIAS	SR21000042	INHUMAS S1	06/12/2020 13:18	07/12/2020 01:29	06/12/2020 13:18	07/12/2020 01:29	12,17	1	12,17	CHI
20201226415	CALDAS NOVAS	10018098108	SERRA DE CALDAS	06/12/2020 13:18	06/12/2020 18:56	06/12/2020 13:18	06/12/2020 18:56	5,62	1	5,62	CHI
20201226417	BURITI ALEGRE	BG21110215	ALTO BURITI	06/12/2020 13:19	06/12/2020 16:33	06/12/2020 13:19	06/12/2020 16:33	3,23	1	3,23	CHI
20201226644	SAO JOAO D ALIANCA	JL11014772	SAO JOAO D ALIANCA	06/12/2020 13:19	06/12/2020 17:57	06/12/2020 13:19	06/12/2020 17:57	4,62	43	198,60	CHI
20201227146	MARA ROSA	ET12000003	MARA ROSA	06/12/2020 13:20	07/12/2020 14:44	06/12/2020 13:20	07/12/2020 14:44	25,39	2	50,78	CHI
20201227146	ESTRELA DO NORTE	ET12000003	MARA ROSA	06/12/2020 13:20	07/12/2020 14:44	06/12/2020 13:20	07/12/2020 14:44	25,39	1	25,39	CHI
20201226540	LUZIANIA	LZ12330544	MARAJOARA	06/12/2020 13:21	06/12/2020 19:37	06/12/2020 13:21	06/12/2020 19:37	6,26	8	50,04	CHI
20201226715	SAO JOAO D ALIANCA	JL12376675LD	ITUIQUIRA	06/12/2020 13:21	07/12/2020 13:16	06/12/2020 13:21	07/12/2020 13:16	23,91	38	908,46	CHI
20201226431	ITUMBIARA	690311631	ITUMBIARA NOVA	06/12/2020 13:22	06/12/2020 19:24	06/12/2020 13:22	06/12/2020 19:24	6,03	1	6,03	CHI
20201226440	CRISTALINA	KR21041576	CRISTALINA S2	06/12/2020 13:23	06/12/2020 18:50	06/12/2020 13:23	06/12/2020 16:37	3,22	1	3,22	CHI
20201226440	IPAMERI	KR10400736	CRISTALINA S2	06/12/2020 13:23	06/12/2020 18:50	06/12/2020 16:32	06/12/2020 18:50	2,29	113	258,68	CHI
20201226440	CRISTALINA	KR10400736	CRISTALINA S2	06/12/2020 13:23	06/12/2020 18:50	06/12/2020 16:32	06/12/2020 18:50	2,29	76	173,98	CHI
20201226440	CRISTALINA	03470454	CRISTALINA S2	06/12/2020 13:23	06/12/2020 18:50	06/12/2020 16:32	06/12/2020 18:50	2,28	38	86,83	CHI
20201226441	GOIANESIA	GE12000150	GOIANESIA S1	06/12/2020 13:24	06/12/2020 18:08	06/12/2020 13:24	06/12/2020 18:08	4,73	3	14,20	CHI
20201226443	SANCLERLANDIA	SC12388895	FIRMINOPOLIS S2	06/12/2020 13:24	06/12/2020 22:19	06/12/2020 13:24	06/12/2020 22:19	8,90	3	26,71	CHI
20201226446	IVOLANDIA	IV21392563	IPORA	06/12/2020 13:25	07/12/2020 09:58	06/12/2020 13:25	07/12/2020 09:58	20,55	1	20,55	CHI
20201226448	JATAI	10008286599	JATAI S3	06/12/2020 13:25	07/12/2020 08:24	06/12/2020 13:25	07/12/2020 08:24	18,97	1	18,97	CHI
20201226454	CRIXAS	CX13394727B	SERRA DO OURO	06/12/2020 13:25	07/12/2020 00:05	06/12/2020 13:25	07/12/2020 00:05	10,67	366	3905,83	CHI
20201226454	NOVA ROMA	CX13394727B	SERRA DO OURO	06/12/2020 13:25	07/12/2020 00:05	06/12/2020 13:25	07/12/2020 00:05	10,67	1	10,67	CHI
20201226454	PORANGATU	CX13394727B	SERRA DO OURO	06/12/2020 13:25	07/12/2020 00:05	06/12/2020 13:25	07/12/2020 00:05	10,67	1	10,67	CHI
20201226454	CRIXAS	CX13394727B	SERRA DO OURO	06/12/2020 13:25	07/12/2020 00:05	06/12/2020 15:42	07/12/2020 00:05	8,39	2	16,78	CHI
20201226457	GOIANIA	15041890	GOIANIA LESTE S3	06/12/2020 13:27	06/12/2020 15:22	06/12/2020 13:27	06/12/2020 15:22	1,90	1	1,90	CHI
20201226468	LUZIANIA	10019417819	RIO VERMELHO	06/12/2020 13:31	07/12/2020 02:20	06/12/2020 13:31	07/12/2020 02:20	12,81	1	12,81	CHI
20201226486	PALMINOPOLIS	PP12077085	PALMEIRAS	06/12/2020 13:31	06/12/2020 19:02	06/12/2020 13:31	06/12/2020 19:02	5,52	5	27,58	CHI
20201227365	AGUA FRIA DE GOIAS	TL12106910	SAO JOAO D ALIANCA	06/12/2020 13:31	06/12/2020 18:41	06/12/2020 13:31	06/12/2020 18:41	5,17	3	15,50	CHI
20201226470	COCALZINHO DE GOIAS	ZN12389403	AGUAS LINDAS DE GOIAS S2	06/12/2020 13:32	06/12/2020 16:20	06/12/2020 13:32	06/12/2020 16:20	2,80	1	2,80	CHI

20201226475	CRISTALINA	KR21199527	PAMPLONA	06/12/2020 13:32	07/12/2020 02:37	06/12/2020 13:32	07/12/2020 02:37	13,07	1	13,07	CHI
20201226873	CRISTALINA	IP12165527	CRISTALINA S1	06/12/2020 13:32	07/12/2020 00:10	06/12/2020 13:32	07/12/2020 00:10	10,63	15	159,45	CHI
20201226477	CIDADE OCIDENTAL	DH12366543	MARAJÓARA	06/12/2020 13:33	06/12/2020 18:26	06/12/2020 13:33	06/12/2020 18:26	4,88	47	229,23	CHI
20201227380	CRISTALINA	KR12037184	CRISTALINA S1	06/12/2020 13:33	06/12/2020 19:15	06/12/2020 13:33	06/12/2020 19:15	5,68	3	17,05	CHI
20201226972	MARA ROSA	MQ12146955	MARA ROSA	06/12/2020 13:36	06/12/2020 19:30	06/12/2020 13:36	06/12/2020 19:30	5,89	12	70,71	CHI
20201226670	GOIATUBA	GT12296905	GOIATUBA S2	06/12/2020 13:37	07/12/2020 10:38	06/12/2020 13:37	07/12/2020 10:01	20,40	6	122,41	CHI
20201226670	GOIATUBA	GT12296905	GOIATUBA S2	06/12/2020 13:37	07/12/2020 10:38	06/12/2020 13:37	07/12/2020 10:38	21,01	1	21,01	CHI
20201226500	AGUA FRIA DE GOIAS	PI21048057	SAO JOAO D ALIANCA	06/12/2020 13:38	06/12/2020 18:34	06/12/2020 13:38	06/12/2020 18:34	4,93	1	4,93	CHI
20201226504	MINACU	IH21244558	MINACU	06/12/2020 13:39	07/12/2020 01:01	06/12/2020 13:39	07/12/2020 01:01	11,36	1	11,36	CHI
20201226506	GOIANIA	17445942	CAMPINAS S2	06/12/2020 13:40	06/12/2020 15:21	06/12/2020 13:40	06/12/2020 15:21	1,68	1	1,68	CHI
20201226511	ANICUNS	910005023	ANICUNS	06/12/2020 13:40	06/12/2020 17:27	06/12/2020 13:40	06/12/2020 17:27	3,78	1	3,78	CHI
20201226577	AMARALINA	LC12270122	SAO MIGUEL DO ARAGUAIA	06/12/2020 13:40	06/12/2020 14:40	06/12/2020 13:40	06/12/2020 14:40	0,99	11	10,84	CHI
20201226526	MONTE ALEGRE DE GOIAS	7475219	SAO DOMINGOS	06/12/2020 13:42	06/12/2020 22:30	06/12/2020 13:42	06/12/2020 22:30	8,80	4	35,18	CHI
20201226530	UIRAPURU	CX21171177	SANTA TEREZINHA	06/12/2020 13:43	06/12/2020 18:01	06/12/2020 13:43	06/12/2020 18:01	4,29	1	4,29	CHI
20201226533	RUBIATABA	RB21000011	RUBIATABA	06/12/2020 13:43	06/12/2020 19:30	06/12/2020 13:43	06/12/2020 19:30	5,77	1	5,77	CHI
20201226539	PORANGATU	SE12064698	MARA ROSA	06/12/2020 13:46	06/12/2020 19:55	06/12/2020 13:46	06/12/2020 19:55	6,15	3	18,45	CHI
20201226539	SANTA TEREZA DE GOIAS	SE12064698	MARA ROSA	06/12/2020 13:46	06/12/2020 19:55	06/12/2020 13:46	06/12/2020 19:55	6,15	2	12,30	CHI
20201226544	LUIZIANIA	LZ21152862	RIO VERMELHO	06/12/2020 13:46	06/12/2020 18:45	06/12/2020 13:46	06/12/2020 18:45	4,97	2	9,94	CHI
20201228227	CAIAPONIA	CP12075058	CAIAPONIA	06/12/2020 13:48	07/12/2020 07:34	06/12/2020 13:48	07/12/2020 07:34	17,75	21	372,83	CHI
20201228227	JATAI	CP12075058	CAIAPONIA	06/12/2020 13:48	07/12/2020 07:34	06/12/2020 13:48	07/12/2020 07:34	17,75	3	53,26	CHI
20201228227	RIO VERDE	CP12075058	CAIAPONIA	06/12/2020 13:48	07/12/2020 07:34	06/12/2020 13:48	07/12/2020 07:34	17,75	4	71,02	CHI
20201226634	AGUA FRIA DE GOIAS	TL12394165	SAO JOAO D ALIANCA	06/12/2020 13:49	06/12/2020 17:41	06/12/2020 13:49	06/12/2020 17:41	3,86	20	77,25	CHI
20201226639	ITABERAI	IB12310490	ITABERAI S2	06/12/2020 13:51	07/12/2020 11:29	06/12/2020 13:51	07/12/2020 11:29	21,63	4	86,52	CHI
20201226783	SANTA CRUZ DE GOIAS	BC12023183	CRISTIANOPOLIS	06/12/2020 13:52	06/12/2020 17:11	06/12/2020 13:52	06/12/2020 17:11	3,32	42	139,25	CHI
20201228516	ORIZONA	OZ12382063	VIANOPOLIS	06/12/2020 13:55	07/12/2020 08:44	06/12/2020 13:55	07/12/2020 08:44	18,80	8	150,41	CHI
20201227194	AGUA FRIA DE GOIAS	PI12048037	SAO JOAO D ALIANCA	06/12/2020 13:56	06/12/2020 20:13	06/12/2020 13:56	06/12/2020 20:13	6,28	7	43,98	CHI
20201226595	GUARAITA	GK11274391	ITAPURANGA	06/12/2020 13:58	06/12/2020 16:09	06/12/2020 13:58	06/12/2020 16:09	2,17	89	193,38	CHI
20201226628	APARECIDA DE GOIANIA	AP11000094	REAL S2	06/12/2020 13:59	06/12/2020 16:00	06/12/2020 13:59	06/12/2020 16:00	2,00	69	138,19	CHI
20201227173	SAO JOAO D ALIANCA	JL12268111	FLORES DE GOIAS	06/12/2020 13:59	06/12/2020 16:53	06/12/2020 13:59	06/12/2020 16:53	2,89	10	28,93	CHI
20201226601	FORMOSA	FA31051162	ITUIQUIRA	06/12/2020 14:00	07/12/2020 13:20	06/12/2020 14:00	07/12/2020 13:20	23,33	1	23,33	CHI
20201226616	QUIRINOPOLIS	QI21143080	QUIRINOPOLIS	06/12/2020 14:02	06/12/2020 19:53	06/12/2020 14:02	06/12/2020 19:53	5,84	1	5,84	CHI
20201226617	SAO DOMINGOS	SD12257602	SAO DOMINGOS	06/12/2020 14:02	06/12/2020 15:46	06/12/2020 14:02	06/12/2020 15:46	1,73	3	5,18	CHI
20201226840	CAIAPONIA	CP12200875	CAIAPONIA	06/12/2020 14:03	07/12/2020 09:52	06/12/2020 14:03	07/12/2020 09:52	19,81	9	178,32	CHI
20201226651	CAIAPONIA	00300214	CAIAPONIA	06/12/2020 14:04	07/12/2020 20:48	06/12/2020 14:04	06/12/2020 18:17	4,21	230	968,62	CHI
20201226651	CAIAPONIA	00300214	CAIAPONIA	06/12/2020 14:04	07/12/2020 20:48	06/12/2020 14:04	06/12/2020 20:09	6,09	5	30,47	CHI
20201226651	CAIAPONIA	00300214	CAIAPONIA	06/12/2020 14:04	07/12/2020 20:48	06/12/2020 22:46	06/12/2020 22:56	0,17	235	39,75	CHI
20201226651	CAIAPONIA	00300214	CAIAPONIA	06/12/2020 14:04	07/12/2020 20:48	06/12/2020 14:04	07/12/2020 09:36	19,54	7	136,80	CHI
20201226651	CAIAPONIA	00300214	CAIAPONIA	06/12/2020 14:04	07/12/2020 20:48	06/12/2020 14:04	07/12/2020 16:22	26,31	78	2051,85	CHI
20201226651	CAIAPONIA	CP12036958RE	CAIAPONIA	06/12/2020 14:04	07/12/2020 20:48	06/12/2020 14:05	07/12/2020 16:22	26,28	1	26,28	CHI
20201226651	CAIAPONIA	00300214	CAIAPONIA	06/12/2020 14:04	07/12/2020 20:48	06/12/2020 14:04	07/12/2020 19:35	29,51	2	59,03	CHI
20201226651	CAIAPONIA	CP13020930	CAIAPONIA	06/12/2020 14:04	07/12/2020 20:48	07/12/2020 20:23	07/12/2020 20:48	0,40	7	2,83	CHI
20201226701	PIRANHAS	PH10426964	PIRANHAS	06/12/2020 14:04	07/12/2020 18:59	06/12/2020 14:04	06/12/2020 14:19	0,26	9	2,34	CHI
20201226701	CAIAPONIA	PH10426964	PIRANHAS	06/12/2020 14:04	07/12/2020 18:59	06/12/2020 14:04	06/12/2020 14:19	0,26	23	5,98	CHI
20201226701	CAIAPONIA	PH10427004	PIRANHAS	06/12/2020 14:04	07/12/2020 18:59	06/12/2020 14:04	07/12/2020 09:57	19,89	61	1213,24	CHI
20201226701	CAIAPONIA	PH10427004	PIRANHAS	06/12/2020 14:04	07/12/2020 18:59	06/12/2020 14:04	07/12/2020 18:59	28,91	3	86,73	CHI
20201226779	GOIANESIA	GE12000185	GOIANESIA S2	06/12/2020 14:04	06/12/2020 15:54	06/12/2020 14:04	06/12/2020 15:54	1,83	6	10,98	CHI
20201226629	CRISTALINA	KR11171014	CRISTALINA S2	06/12/2020 14:05	06/12/2020 22:18	06/12/2020 14:05	06/12/2020 22:18	8,22	1	8,22	CHI
20201226642	AMARALINA	LC21334391	MARA ROSA	06/12/2020 14:07	07/12/2020 15:40	06/12/2020 14:07	07/12/2020 15:40	25,54	1	25,54	CHI
20201226648	FIRMINOPOLIS	FR21096985	FIRMINOPOLIS S1	06/12/2020 14:08	06/12/2020 21:06	06/12/2020 14:08	06/12/2020 21:06	6,96	1	6,96	CHI
20201226662	GOIANIA	12279456	GOYA S2	06/12/2020 14:08	06/12/2020 16:33	06/12/2020 14:08	06/12/2020 16:33	2,41	1	2,41	CHI
20201228592	PLANALTINA	TL12320532	SAO JOAO D ALIANCA	06/12/2020 14:08	06/12/2020 23:13	06/12/2020 14:08	06/12/2020 23:13	9,08	5	45,41	CHI

20201226653	CATALAO	1990327336	CATALAO S2	06/12/2020 14:09	06/12/2020 16:00	06/12/2020 14:09	06/12/2020 16:00	1,84	1	1,84	CHI
20201226751	ITAUCU	PV12246847	CORUMBA	06/12/2020 14:10	06/12/2020 15:44	06/12/2020 14:10	06/12/2020 15:44	1,56	1	1,56	CHI
20201226751	PIRENOPOLIS	PV12246847	CORUMBA	06/12/2020 14:10	06/12/2020 15:44	06/12/2020 14:10	06/12/2020 15:44	1,56	77	120,44	CHI
20201227446	MOSSAMEDES	MD12119449	ANICUNS	06/12/2020 14:10	06/12/2020 17:57	06/12/2020 14:10	06/12/2020 17:57	3,78	16	60,45	CHI
20201226666	VILA BOA	VB21202227	ITUIQUIRA	06/12/2020 14:12	07/12/2020 13:07	06/12/2020 14:12	07/12/2020 13:07	22,92	1	22,92	CHI
20201226677	GOIANIA	10005304936	CARAJAS S2	06/12/2020 14:13	06/12/2020 15:29	06/12/2020 14:13	06/12/2020 15:29	1,26	1	1,26	CHI
20201226678	AGUA FRIA DE GOIAS	TL12337434	SAO JOAO D ALIANCA	06/12/2020 14:13	08/12/2020 16:20	06/12/2020 14:13	08/12/2020 16:20	50,12	1	50,12	CHI
20201227221	PIRENOPOLIS	PV11264950	CORUMBA	06/12/2020 14:13	06/12/2020 17:36	06/12/2020 14:13	06/12/2020 17:36	3,37	40	134,92	CHI
20201227417	PALESTINA DE GOIAS	03800506	PALESTINA	06/12/2020 14:13	06/12/2020 22:53	06/12/2020 14:13	06/12/2020 22:51	8,63	20	172,59	CHI
20201227417	PALESTINA DE GOIAS	03800506	PALESTINA	06/12/2020 14:13	06/12/2020 22:53	06/12/2020 14:13	06/12/2020 22:53	8,67	887	7688,32	CHI
20201227653	GOIATUBA	MR12190892	GOIATUBA S2	06/12/2020 14:13	06/12/2020 19:29	06/12/2020 14:13	06/12/2020 19:29	5,26	10	52,62	CHI
2020120600069	PALESTINA DE GOIAS	03800224	PALESTINA	06/12/2020 14:13	06/12/2020 22:51	06/12/2020 14:13	06/12/2020 22:51	8,63	178	1536,73	CHI
2020120600069	CAIAPONIA	03800224	PALESTINA	06/12/2020 14:13	06/12/2020 22:51	06/12/2020 14:13	06/12/2020 22:51	8,63	387	3341,10	CHI
20201226729	ARAGUAPAZ	AZ12042979	MOZARLANDIA	06/12/2020 14:14	06/12/2020 16:09	06/12/2020 14:14	06/12/2020 16:09	1,91	10	19,11	CHI
20201227228	GOIANIRA	BW12291579	NEROPOLIS S1	06/12/2020 14:14	06/12/2020 19:11	06/12/2020 14:14	06/12/2020 19:11	4,95	3	14,85	CHI
20201227228	SANTO ANTONIO DE GOIAS	BW12291579	NEROPOLIS S1	06/12/2020 14:14	06/12/2020 19:11	06/12/2020 14:14	06/12/2020 19:11	4,95	2	9,90	CHI
20201226743	AMARALINA	LC12270111	SAO MIGUEL DO ARAGUAIA	06/12/2020 14:15	06/12/2020 17:30	06/12/2020 14:15	06/12/2020 17:30	3,24	5	16,19	CHI
20201226823	PIRENOPOLIS	PV12034069	CORUMBA	06/12/2020 14:15	06/12/2020 17:26	06/12/2020 14:15	06/12/2020 17:26	3,18	80	254,40	CHI
20201226695	ITUMBIARA	CD21000066	CACHOEIRA DOURADA	06/12/2020 14:17	06/12/2020 18:53	06/12/2020 14:17	06/12/2020 18:53	4,59	1	4,59	CHI
20201227865	VIANOPOLIS	VN12034204	VIANOPOLIS	06/12/2020 14:18	06/12/2020 18:57	06/12/2020 14:18	06/12/2020 18:57	4,64	11	51,04	CHI
20201227200	RUBIATABA	RB12292125	RUBIATABA	06/12/2020 14:19	06/12/2020 17:53	06/12/2020 14:19	06/12/2020 17:53	3,56	3	10,69	CHI
20201226702	ARUANA	AK11183276	ARUANA	06/12/2020 14:20	06/12/2020 16:42	06/12/2020 14:20	06/12/2020 16:42	2,36	24	56,74	CHI
20201226708	RIO VERDE	10000833531	RIO VERDE S1	06/12/2020 14:21	06/12/2020 23:15	06/12/2020 14:21	06/12/2020 23:15	8,89	1	8,89	CHI
20201226950	APARECIDA DE GOIANIA	AP12149479	INDEPENDENCIA S2	06/12/2020 14:22	06/12/2020 16:50	06/12/2020 14:22	06/12/2020 16:50	2,46	515	1266,04	CHI
20201226714	ARAGUAPAZ	AZ12253302	RUBIATABA	06/12/2020 14:23	09/12/2020 13:38	06/12/2020 14:23	08/12/2020 13:59	47,61	3	142,83	CHI
20201226714	ARAGUAPAZ	AZ12253302	RUBIATABA	06/12/2020 14:23	09/12/2020 13:38	06/12/2020 14:23	08/12/2020 15:33	49,17	7	344,16	CHI
20201226714	ARAGUAPAZ	AZ12253302	RUBIATABA	06/12/2020 14:23	09/12/2020 13:38	06/12/2020 14:23	08/12/2020 15:40	49,28	10	492,82	CHI
20201226714	ARAGUAPAZ	AZ12253302	RUBIATABA	06/12/2020 14:23	09/12/2020 13:38	06/12/2020 14:23	09/12/2020 13:38	71,25	1	71,25	CHI
20201226919	AMARALINA	LC12248963	MARA ROSA	06/12/2020 14:23	06/12/2020 20:09	06/12/2020 14:23	06/12/2020 20:09	5,76	23	132,54	CHI
20201227017	MORRO AGUDO DE GOIAS	IK12172710	ITAPURANGA	06/12/2020 14:23	06/12/2020 19:31	06/12/2020 14:23	06/12/2020 19:31	5,12	7	35,85	CHI
20201227017	ITAPURANGA	IK12172710	ITAPURANGA	06/12/2020 14:23	06/12/2020 19:31	06/12/2020 14:23	06/12/2020 19:31	5,12	3	15,36	CHI
20201226722	SAO MIGUEL DO ARAGUAIA	10002229283	SAO MIGUEL DO ARAGUAIA	06/12/2020 14:24	07/12/2020 20:01	06/12/2020 14:24	07/12/2020 20:01	29,61	1	29,61	CHI
20201226731	NOVA GLORIA	IW21245606	RUBIATABA	06/12/2020 14:26	06/12/2020 20:53	06/12/2020 14:26	06/12/2020 20:53	6,44	2	12,88	CHI
20201227636	RUBIATABA	IW12238565	RUBIATABA	06/12/2020 14:26	07/12/2020 10:06	06/12/2020 14:26	07/12/2020 10:06	19,67	1	19,67	CHI
20201227636	ITAPACI	IW12238565	RUBIATABA	06/12/2020 14:26	07/12/2020 10:06	06/12/2020 14:26	07/12/2020 10:06	19,67	18	353,98	CHI
20201227805	LUZIANIA	LZ12290786	RIO VERMELHO	06/12/2020 14:26	06/12/2020 19:35	06/12/2020 14:26	06/12/2020 19:35	5,15	89	458,35	CHI
20201226737	GOIATUBA	GT21190843	GOIATUBA S2	06/12/2020 14:28	06/12/2020 17:12	06/12/2020 14:28	06/12/2020 17:12	2,72	1	2,72	CHI
20201226986	CRIXAS	CX12018361	SERRA DO OURO	06/12/2020 14:28	06/12/2020 16:28	06/12/2020 14:28	06/12/2020 16:28	1,98	353	700,21	CHI
20201227110	CRIXAS	CX11108000	SERRA DO OURO	06/12/2020 14:29	06/12/2020 22:36	06/12/2020 14:29	06/12/2020 22:36	8,11	148	1200,73	CHI
20201226744	ITUMBIARA	IT12024221	CACHOEIRA DOURADA	06/12/2020 14:30	06/12/2020 18:48	06/12/2020 14:30	06/12/2020 18:48	4,31	3	12,92	CHI
20201226746	PIRANHAS	10007856120	ARENOPOLIS	06/12/2020 14:30	07/12/2020 10:06	06/12/2020 14:30	07/12/2020 10:06	19,60	1	19,60	CHI
20201226749	AMARALINA	LC12182475	SAO MIGUEL DO ARAGUAIA	06/12/2020 14:30	06/12/2020 17:02	06/12/2020 14:30	06/12/2020 17:02	2,53	78	197,69	CHI
20201226752	PIRANHAS	PH12252502	PIRANHAS	06/12/2020 14:31	06/12/2020 16:56	06/12/2020 14:31	06/12/2020 16:56	2,41	1	2,41	CHI
20201226754	ITAPURANGA	IK12250554	ITAPURANGA	06/12/2020 14:32	06/12/2020 17:08	06/12/2020 14:32	06/12/2020 17:08	2,60	6	15,60	CHI
20201227145	PLANALTINA	PI11164647	PLANALTINA	06/12/2020 14:33	06/12/2020 18:12	06/12/2020 14:33	06/12/2020 18:12	3,65	119	434,32	CHI
20201226765	MORRINHOS	10029778733	MORRINHOS	06/12/2020 14:34	06/12/2020 18:52	06/12/2020 14:34	06/12/2020 18:52	4,29	1	4,29	CHI
20201226775	PILAR DE GOIAS	NH16410911	SANTA TEREZINHA	06/12/2020 14:37	07/12/2020 23:21	06/12/2020 16:37	06/12/2020 17:55	1,31	2	2,61	CHI
20201226775	PILAR DE GOIAS	NH16410911	SANTA TEREZINHA	06/12/2020 14:37	07/12/2020 23:21	06/12/2020 16:37	06/12/2020 18:03	1,43	11	15,75	CHI
20201226775	ALTO HORIZONTE	NH16410911	SANTA TEREZINHA	06/12/2020 14:37	07/12/2020 23:21	06/12/2020 16:37	06/12/2020 18:03	1,43	10	14,31	CHI
20201226775	NOVA IGUACU DE GOIAS	NH16410911	SANTA TEREZINHA	06/12/2020 14:37	07/12/2020 23:21	06/12/2020 16:37	06/12/2020 18:03	1,43	29	41,51	CHI
20201226775	PILAR DE GOIAS	NH16410911	SANTA TEREZINHA	06/12/2020 14:37	07/12/2020 23:21	06/12/2020 16:37	07/12/2020 23:21	30,74	5	153,69	CHI

20201226775	ALTO HORIZONTE	NH16410911	SANTA TEREZINHA	06/12/2020 14:37	07/12/2020 23:21	06/12/2020 16:37	07/12/2020 23:21	30,74	2	61,48	CHI
20201226775	SANTA TEREZINHA DE GOIAS	NH16410911	SANTA TEREZINHA	06/12/2020 14:37	07/12/2020 23:21	06/12/2020 16:37	07/12/2020 23:21	30,74	23	706,96	CHI
20201226782	ITAGUARU	IC12353099RE	ITABERAI S1	06/12/2020 14:38	06/12/2020 17:51	06/12/2020 14:38	06/12/2020 17:51	3,21	70	224,99	CHI
20201226782	URUANA	IC12353099RE	ITABERAI S1	06/12/2020 14:38	06/12/2020 17:51	06/12/2020 14:38	06/12/2020 17:51	3,21	10	32,14	CHI
20201226784	VALPARAISO DE GOIAS	2860017805	PACAEMBU S1	06/12/2020 14:38	06/12/2020 17:06	06/12/2020 14:38	06/12/2020 17:06	2,46	1	2,46	CHI
20201226786	GOIANIA	10131851	FERROVIARIO S3	06/12/2020 14:38	06/12/2020 16:30	06/12/2020 14:38	06/12/2020 16:30	1,85	1	1,85	CHI
20201226855	APARECIDA DE GOIANIA	AP11051629	REAL S1	06/12/2020 14:38	06/12/2020 18:42	06/12/2020 14:38	06/12/2020 18:42	4,05	274	1110,16	CHI
20201227939	TROMBAS	MX12240734	PORANGATU	06/12/2020 14:38	07/12/2020 10:44	06/12/2020 14:38	07/12/2020 10:44	20,09	1	20,09	CHI
20201227939	MONTIVIDIU DO NORTE	MX12240734	PORANGATU	06/12/2020 14:38	07/12/2020 10:44	06/12/2020 14:38	07/12/2020 10:44	20,09	8	160,74	CHI
20201226792	RIO VERDE	RV12202814	CABRIUVA S1	06/12/2020 14:39	06/12/2020 22:21	06/12/2020 14:39	06/12/2020 22:21	7,69	2	15,38	CHI
20201226794	FAINA	8540277	GOIAS	06/12/2020 14:40	06/12/2020 16:47	06/12/2020 14:40	06/12/2020 16:47	2,12	4	8,47	CHI
20201226796	FORMOSA	FA21180669	ITUIQUIRA	06/12/2020 14:40	07/12/2020 08:42	06/12/2020 14:40	07/12/2020 08:42	18,02	1	18,02	CHI
20201226800	APARECIDA DE GOIANIA	17108299	REAL S1	06/12/2020 14:41	06/12/2020 18:37	06/12/2020 14:41	06/12/2020 18:37	3,93	1	3,93	CHI
20201227178	CRIXAS	CX12000035	SERRA DO OURO	06/12/2020 14:41	07/12/2020 03:08	06/12/2020 14:41	07/12/2020 03:08	12,45	69	858,82	CHI
20201226814	ITABERAI	IB21027643	ITABERAI S2	06/12/2020 14:43	07/12/2020 09:04	06/12/2020 14:43	07/12/2020 09:04	18,34	1	18,34	CHI
20201227123	FORMOSA	FA12146108	ITUIQUIRA	06/12/2020 14:44	06/12/2020 18:30	06/12/2020 14:44	06/12/2020 18:30	3,76	33	124,11	CHI
20201227491	AMARALINA	LC12278480	MARA ROSA	06/12/2020 14:44	06/12/2020 18:29	06/12/2020 14:44	06/12/2020 18:29	3,75	3	11,25	CHI
20201226827	ITAPURANGA	IK12300342	ITAPURANGA	06/12/2020 14:45	06/12/2020 16:36	06/12/2020 14:45	06/12/2020 16:36	1,83	38	69,71	CHI
20201226976	NIQUELANDIA	NQ12135523	URUACU	06/12/2020 14:45	06/12/2020 19:10	06/12/2020 14:45	06/12/2020 19:10	4,40	3	13,20	CHI
20201222775	GOIATUBA	GT21033080	BOM JESUS DE GOIAS	06/12/2020 14:46	06/12/2020 22:49	06/12/2020 14:46	06/12/2020 22:49	8,05	1	8,05	CHI
20201226836	JANDIAIA	JD21358578	PALMEIRAS	06/12/2020 14:47	06/12/2020 22:30	06/12/2020 14:47	06/12/2020 22:30	7,71	1	7,71	CHI
20201226845	SANTA BARBARA DE GOIAS	SB12186355	TRINDADE	06/12/2020 14:48	06/12/2020 15:55	06/12/2020 14:48	06/12/2020 15:55	1,10	9	9,92	CHI
20201226867	CRISTALINA	KR12304869	CRISTALINA S2	06/12/2020 14:48	06/12/2020 21:12	06/12/2020 14:48	06/12/2020 21:12	6,39	16	102,21	CHI
20201226854	AMARALINA	LC11270191	SÃO MIGUEL DO ARAGUAIA	06/12/2020 14:49	06/12/2020 17:51	06/12/2020 14:49	06/12/2020 17:51	3,02	1	3,02	CHI
20201226858	CORUMBA DE GOIAS	CB21172018	CORUMBA	06/12/2020 14:50	07/12/2020 02:37	06/12/2020 14:50	07/12/2020 02:37	11,78	2	23,56	CHI
20201227594	PLANALTINA	PI12146089	SÃO JOÃO D ALIANÇA	06/12/2020 14:50	07/12/2020 10:38	06/12/2020 14:50	07/12/2020 10:38	19,79	20	395,71	CHI
20201226872	ANAPOLIS	20727033	ANAPOLIS UNIVERSITARIO S2	06/12/2020 14:52	06/12/2020 19:35	06/12/2020 14:52	06/12/2020 19:35	4,71	1	4,71	CHI
20201226876	PONTALINA	210053148	PONTALINA	06/12/2020 14:52	06/12/2020 20:12	06/12/2020 14:52	06/12/2020 20:12	5,32	1	5,32	CHI
20201227730	MORRO AGUDO DE GOIAS	RB12026401RE	ITAPURANGA	06/12/2020 14:52	07/12/2020 04:42	06/12/2020 14:52	07/12/2020 04:42	13,83	134	1853,59	CHI
20201227730	RUBIATABA	RB12026401RE	ITAPURANGA	06/12/2020 14:52	07/12/2020 04:42	06/12/2020 14:52	07/12/2020 04:42	13,83	4	55,33	CHI
20201226884	PIRES DO RIO	PR12031289	PIRES DO RIO S1	06/12/2020 14:53	06/12/2020 23:28	06/12/2020 14:53	06/12/2020 23:28	8,57	1	8,57	CHI
20201226884	PALMELO	PR12031289	PIRES DO RIO S1	06/12/2020 14:53	06/12/2020 23:28	06/12/2020 14:53	06/12/2020 23:28	8,57	4	34,29	CHI
20201226886	ITABERAI	IB12300330	ITABERAI S2	06/12/2020 14:53	07/12/2020 09:17	06/12/2020 14:53	07/12/2020 09:17	18,39	14	257,42	CHI
20201227265	BURITI ALEGRE	MR12041248	GOIATUBA S2	06/12/2020 14:53	06/12/2020 22:08	06/12/2020 14:53	06/12/2020 22:08	7,26	3	21,78	CHI
20201227265	GOIATUBA	MR12041248	GOIATUBA S2	06/12/2020 14:53	06/12/2020 22:08	06/12/2020 14:53	06/12/2020 22:08	7,26	2	14,52	CHI
20201226892	CRISTALINA	KR21406236	CRISTALINA S1	06/12/2020 14:54	07/12/2020 10:52	06/12/2020 14:54	07/12/2020 10:52	19,96	2	39,92	CHI
20201226893	CIDADE OCIDENTAL	DH12170612	MARAJÓARA	06/12/2020 14:54	06/12/2020 18:20	06/12/2020 14:54	06/12/2020 18:20	3,42	15	51,35	CHI
20201226894	FORMOSA	FA31096307	SÃO JOÃO D ALIANÇA	06/12/2020 14:54	07/12/2020 16:12	06/12/2020 14:54	07/12/2020 16:12	25,29	2	50,58	CHI
20201227086	GOIANESIA	GE12000085	GOIANESIA S2	06/12/2020 14:54	06/12/2020 16:41	06/12/2020 14:54	06/12/2020 16:41	1,78	92	163,30	CHI
20201228506	AMARALINA	LC12170975	MARA ROSA	06/12/2020 14:54	06/12/2020 23:29	06/12/2020 14:54	06/12/2020 23:29	8,58	11	94,35	CHI
20201226898	ARAGUAPAZ	AZ12242480	MOZARLANDIA	06/12/2020 14:56	06/12/2020 16:48	06/12/2020 14:56	06/12/2020 16:48	1,86	16	29,80	CHI
20201226904	ITAPURANGA	IK12023682	ITAPURANGA	06/12/2020 14:57	07/12/2020 09:56	06/12/2020 14:57	07/12/2020 09:56	18,98	7	132,84	CHI
20201226914	COCALZINHO DE GOIAS	ZN21153761	AGUAS LINDAS DE GOIAS S2	06/12/2020 14:58	06/12/2020 17:41	06/12/2020 14:58	06/12/2020 17:41	2,71	1	2,71	CHI
20201226916	NOVA IGUAÇU DE GOIAS	NH12094070	CAMPINORTE	06/12/2020 14:58	07/12/2020 10:30	06/12/2020 14:58	07/12/2020 10:30	19,52	6	117,11	CHI
20201226917	GOIAS	GS12248147	ITABERAI S1	06/12/2020 14:58	06/12/2020 20:24	06/12/2020 14:58	06/12/2020 20:24	5,42	6	32,51	CHI
20201227091	GUARINOS	IW12201636	ITAPACI	06/12/2020 14:58	06/12/2020 21:13	06/12/2020 14:58	06/12/2020 21:13	6,24	7	43,69	CHI
20201227091	PILAR DE GOIAS	IW12201636	ITAPACI	06/12/2020 14:58	06/12/2020 21:13	06/12/2020 14:58	06/12/2020 21:13	6,24	1	6,24	CHI
20201227091	ITAPACI	IW12201636	ITAPACI	06/12/2020 14:58	06/12/2020 21:13	06/12/2020 14:58	06/12/2020 21:13	6,24	252	1572,76	CHI
20201227227	ARUANA	AK12250801	ARUANA	06/12/2020 14:58	06/12/2020 17:40	06/12/2020 14:58	06/12/2020 17:40	2,70	164	442,44	CHI
20201226918	GOIANIA	14460762	FERROVIARIO S1	06/12/2020 14:59	06/12/2020 16:59	06/12/2020 14:59	06/12/2020 16:59	2,00	1	2,00	CHI
20201226923	FORMOSA	FA21180737	ITUIQUIRA	06/12/2020 14:59	07/12/2020 18:50	06/12/2020 14:59	07/12/2020 18:50	27,84	1	27,84	CHI

20201226924	INHUMAS	10026491328	INHUMAS S2	06/12/2020 14:59	06/12/2020 17:38	06/12/2020 14:59	06/12/2020 17:38	2,64	1	2,64	CHI
20201226926	INDIARA	2710014161	EDEIA	06/12/2020 15:00	06/12/2020 21:04	06/12/2020 15:00	06/12/2020 21:04	6,06	1	6,06	CHI
20201226928	NIQUELANDIA	NQ21243379	URUACU	06/12/2020 15:00	06/12/2020 21:10	06/12/2020 15:00	06/12/2020 21:10	6,16	10	61,64	CHI
20201226929	AGUA FRIA DE GOIAS	TL21320630	SAO JOAO D ALIANCA	06/12/2020 15:00	06/12/2020 22:37	06/12/2020 15:00	06/12/2020 22:37	7,61	1	7,61	CHI
20201226931	TRINDADE	10017833793	TRINDADE	06/12/2020 15:00	06/12/2020 16:17	06/12/2020 15:00	06/12/2020 16:17	1,27	1	1,27	CHI
20201227907	MOSSAMEDES	MD21020697	ITABERAI S2	06/12/2020 15:00	07/12/2020 14:21	06/12/2020 15:00	07/12/2020 13:48	22,81	2	45,62	CHI
20201227907	MOSSAMEDES	MD12299611LD	ITABERAI S2	06/12/2020 15:00	07/12/2020 14:21	06/12/2020 15:00	07/12/2020 14:21	23,35	93	2171,91	CHI
20201227082	MINACU	IH11311567	MINACU	06/12/2020 15:01	06/12/2020 20:49	06/12/2020 15:01	06/12/2020 20:49	5,79	36	208,52	CHI
20201226939	MORRINHOS	MR21121324	MORRINHOS	06/12/2020 15:03	06/12/2020 20:24	06/12/2020 15:03	06/12/2020 20:24	5,35	1	5,35	CHI
20201226965	ITAPURANGA	IK12250614	ITAPURANGA	06/12/2020 15:03	07/12/2020 23:45	06/12/2020 15:03	07/12/2020 23:45	32,71	21	686,99	CHI
20201226965	GOIAS	IK12250614	ITAPURANGA	06/12/2020 15:03	07/12/2020 23:45	06/12/2020 15:03	07/12/2020 23:45	32,71	2	65,43	CHI
20201226965	GUARAITA	IK12250614	ITAPURANGA	06/12/2020 15:03	07/12/2020 23:45	06/12/2020 15:03	07/12/2020 23:45	32,71	18	588,84	CHI
20201226965	ITAPURANGA	IK12250614	ITAPURANGA	06/12/2020 15:03	07/12/2020 23:45	06/12/2020 20:58	07/12/2020 23:45	26,78	1	26,78	CHI
20201226994	RIO VERDE	RV12249020	CABRIUVA S2	06/12/2020 15:03	06/12/2020 18:26	06/12/2020 15:03	06/12/2020 18:26	3,38	17	57,38	CHI
20201226955	URUACU	UR12082989	URUACU	06/12/2020 15:05	06/12/2020 17:46	06/12/2020 15:05	06/12/2020 17:46	2,68	6	16,06	CHI
20201227230	JARAGUA	JA12298032	JARAGUA	06/12/2020 15:06	06/12/2020 21:29	06/12/2020 15:06	06/12/2020 21:29	6,38	141	898,95	CHI
20201227941	SAO LUIZ DO NORTE	GE12382134	BARRO ALTO	06/12/2020 15:07	07/12/2020 12:15	06/12/2020 15:07	07/12/2020 12:15	21,12	5	105,60	CHI
20201227941	HIDROLINA	GE12382134	BARRO ALTO	06/12/2020 15:07	07/12/2020 12:15	06/12/2020 15:07	07/12/2020 12:15	21,12	1	21,12	CHI
20201226964	LUZIANIA	120195355	RIO VERMELHO	06/12/2020 15:08	07/12/2020 07:47	06/12/2020 15:08	07/12/2020 07:47	16,65	1	16,65	CHI
20201226966	QUIRINOPOLIS	QI31015006	QUIRINOPOLIS	06/12/2020 15:08	06/12/2020 16:56	06/12/2020 15:08	06/12/2020 16:56	1,80	1	1,80	CHI
20201226967	AMARALINA	LC12308828	MARA ROSA	06/12/2020 15:08	07/12/2020 08:40	06/12/2020 15:08	07/12/2020 08:40	17,53	2	35,06	CHI
20201226967	MARA ROSA	LC12308828	MARA ROSA	06/12/2020 15:08	07/12/2020 08:40	06/12/2020 15:08	07/12/2020 08:40	17,53	1	17,53	CHI
20201226969	INHUMAS	IN11373073	INHUMAS S2	06/12/2020 15:08	06/12/2020 15:48	06/12/2020 15:08	06/12/2020 15:48	0,66	196	128,76	CHI
20201227660	BALIZA	BH12061407	BOM JARDIM	06/12/2020 15:08	06/12/2020 20:46	06/12/2020 15:08	06/12/2020 20:46	5,63	31	174,41	CHI
20201226982	MINEIROS	MY21358111	PARQUE DAS EMAS	06/12/2020 15:09	06/12/2020 19:47	06/12/2020 15:09	06/12/2020 19:47	4,62	1	4,62	CHI
20201226989	GOIANESIA	PV10219138	CORUMBA	06/12/2020 15:09	06/12/2020 15:17	06/12/2020 15:09	06/12/2020 15:17	0,14	11	1,50	CHI
20201226989	VILA PROPICIO	PV10219138	CORUMBA	06/12/2020 15:09	06/12/2020 15:17	06/12/2020 15:09	06/12/2020 15:17	0,14	16	2,18	CHI
20201226989	PIRENOPOLIS	PV10219138	CORUMBA	06/12/2020 15:09	06/12/2020 15:17	06/12/2020 15:09	06/12/2020 15:17	0,14	1476	200,90	CHI
20201226989	JARAGUA	PV10219138	CORUMBA	06/12/2020 15:09	06/12/2020 15:17	06/12/2020 15:09	06/12/2020 15:17	0,14	4	0,54	CHI
20201226989	ANAPOLIS	PV10219138	CORUMBA	06/12/2020 15:09	06/12/2020 15:17	06/12/2020 15:09	06/12/2020 15:17	0,14	1	0,14	CHI
20201226979	MOSSAMEDES	MD12091062	FIRMINOPOLIS S2	06/12/2020 15:10	06/12/2020 23:39	06/12/2020 15:10	06/12/2020 23:39	8,47	1	8,47	CHI
20201226981	MINEIROS	MY12303914	PARQUE DAS EMAS	06/12/2020 15:11	06/12/2020 15:41	06/12/2020 15:11	06/12/2020 15:41	0,50	2	0,99	CHI
20201227670	CRISTALINA	KR12133541LD	CRISTALINA S1	06/12/2020 15:12	06/12/2020 20:14	06/12/2020 15:12	06/12/2020 20:14	5,02	20	100,37	CHI
20201226993	EDEIA	EA21313348	EDEIA	06/12/2020 15:14	06/12/2020 22:28	06/12/2020 15:14	06/12/2020 22:28	7,22	1	7,22	CHI
20201227961	MINACU	IH12360453	MINACU	06/12/2020 15:14	08/12/2020 12:48	06/12/2020 15:14	06/12/2020 23:59	8,76	14	122,61	CHI
20201227961	MINACU	IH12360453	MINACU	06/12/2020 15:14	08/12/2020 12:48	07/12/2020 05:37	07/12/2020 08:41	3,08	14	43,07	CHI
20201227961	MINACU	IH12360453	MINACU	06/12/2020 15:14	08/12/2020 12:48	06/12/2020 15:14	07/12/2020 13:16	22,03	3	66,10	CHI
20201227961	MINACU	IH12360453	MINACU	06/12/2020 15:14	08/12/2020 12:48	06/12/2020 15:14	07/12/2020 16:20	25,11	25	627,77	CHI
20201227961	MINACU	IH12360453	MINACU	06/12/2020 15:14	08/12/2020 12:48	06/12/2020 15:14	07/12/2020 17:16	26,04	5	130,22	CHI
20201227961	MINACU	IH12360453	MINACU	06/12/2020 15:14	08/12/2020 12:48	06/12/2020 15:14	07/12/2020 17:30	26,26	23	604,02	CHI
20201227961	CAMPINACU	IH12360453	MINACU	06/12/2020 15:14	08/12/2020 12:48	06/12/2020 15:14	07/12/2020 17:30	26,26	5	131,31	CHI
20201227961	MINACU	IH12360453	MINACU	06/12/2020 15:14	08/12/2020 12:48	06/12/2020 15:14	07/12/2020 22:30	31,28	1	31,28	CHI
20201227961	MINACU	IH12360453	MINACU	06/12/2020 15:14	08/12/2020 12:48	08/12/2020 02:06	08/12/2020 03:56	1,83	13	23,75	CHI
20201227961	MINACU	IH12360453	MINACU	06/12/2020 15:14	08/12/2020 12:48	06/12/2020 15:14	08/12/2020 12:48	45,57	1	45,57	CHI
20201227961	CAMPINACU	IH12360453	MINACU	06/12/2020 15:14	08/12/2020 12:48	08/12/2020 02:06	08/12/2020 12:48	10,70	5	53,50	CHI
20201227961	MINACU	IH12360453	MINACU	06/12/2020 15:14	08/12/2020 12:48	08/12/2020 02:06	08/12/2020 12:48	10,70	58	620,60	CHI
20201227006	URUACU	UR21094161	CAMPINORTE	06/12/2020 15:16	06/12/2020 19:23	06/12/2020 15:16	06/12/2020 19:23	4,10	4	16,40	CHI
20201227022	CRISTALINA	KR10409765	PAMPLONA	06/12/2020 15:16	07/12/2020 15:36	06/12/2020 15:16	06/12/2020 19:46	4,51	11	49,63	CHI
20201227022	CRISTALINA	KR12168098LD	PAMPLONA	06/12/2020 15:16	07/12/2020 15:36	06/12/2020 15:16	07/12/2020 03:52	12,61	3	37,82	CHI
20201227022	CRISTALINA	KR12320123LD	PAMPLONA	06/12/2020 15:16	07/12/2020 15:36	06/12/2020 15:16	07/12/2020 15:36	24,35	33	803,41	CHI
20201227013	URUACU	UR21000029	CAMPINORTE	06/12/2020 15:18	06/12/2020 18:25	06/12/2020 15:18	06/12/2020 18:25	3,11	1	3,11	CHI

20201227015	FAINA	FC21332580	GOIAS	06/12/2020 15:18	06/12/2020 18:30	06/12/2020 15:18	06/12/2020 18:30	3,19	1	3,19	CHI
20201227020	ANAPOLIS	20491803	ANAPOLIS UNIVERSITARIO S2	06/12/2020 15:18	06/12/2020 16:55	06/12/2020 15:18	06/12/2020 16:55	1,61	1	1,61	CHI
20201227049	LUZIANIA	LZ12110889	RIO VERMELHO	06/12/2020 15:18	06/12/2020 16:27	06/12/2020 15:18	06/12/2020 16:27	1,15	7	8,02	CHI
20201227026	SANTA HELENA DE GOIAS	SH12271332	IPEGUARI	06/12/2020 15:19	06/12/2020 19:53	06/12/2020 15:19	06/12/2020 19:53	4,56	1	4,56	CHI
20201227032	SAO JOAO D ALIANCA	JL12268110	FLORES DE GOIAS	06/12/2020 15:20	06/12/2020 16:27	06/12/2020 15:20	06/12/2020 16:27	1,11	9	9,98	CHI
20201227816	MONTIVIDIU DO NORTE	MX12391928	PORANGATU	06/12/2020 15:20	08/12/2020 09:10	06/12/2020 15:20	08/12/2020 09:10	41,82	20	836,41	CHI
20201227036	CAMPOS BELOS	CH11261952	SAO DOMINGOS	06/12/2020 15:21	06/12/2020 16:39	06/12/2020 15:21	06/12/2020 16:39	1,29	143	183,79	CHI
20201227038	ITABERAI	IB12274216	ITABERAI S2	06/12/2020 15:22	06/12/2020 16:58	06/12/2020 15:22	06/12/2020 16:58	1,59	3	4,77	CHI
20201227043	COLINAS DO SUL	TI12155523RE	MINACU	06/12/2020 15:23	07/12/2020 04:57	06/12/2020 15:23	07/12/2020 04:57	13,56	18	243,99	CHI
20201227045	NEROPOLIS	NR11187232	NEROPOLIS S2	06/12/2020 15:23	06/12/2020 16:58	06/12/2020 15:23	06/12/2020 16:58	1,57	68	106,67	CHI
20201227061	DAVINOPOLIS	IO12085096	CATALAO S1	06/12/2020 15:23	06/12/2020 18:10	06/12/2020 15:23	06/12/2020 18:10	2,78	7	19,44	CHI
20201227061	TRES RANCHOS	IO12085096	CATALAO S1	06/12/2020 15:23	06/12/2020 18:10	06/12/2020 15:23	06/12/2020 18:10	2,78	4	11,11	CHI
20201227061	OUVIDOR	IO12085096	CATALAO S1	06/12/2020 15:23	06/12/2020 18:10	06/12/2020 15:23	06/12/2020 18:10	2,78	2	5,55	CHI
20201227047	PIRES DO RIO	PR21222674	PIRES DO RIO S1	06/12/2020 15:24	06/12/2020 19:23	06/12/2020 15:24	06/12/2020 19:23	3,98	1	3,98	CHI
20201229134	PORANGATU	MU12266664	MARA ROSA	06/12/2020 15:24	06/12/2020 23:50	06/12/2020 15:24	06/12/2020 23:50	8,44	48	404,96	CHI
20201227062	PONTALINA	PK31045999	PONTALINA	06/12/2020 15:25	06/12/2020 17:04	06/12/2020 15:25	06/12/2020 17:04	1,63	1	1,63	CHI
20201227063	LUZIANIA	LZ21087397	MARAJOARA	06/12/2020 15:25	06/12/2020 20:00	06/12/2020 15:25	06/12/2020 20:00	4,57	1	4,57	CHI
20201227247	ITAPURANGA	IK12187039	ITAPURANGA	06/12/2020 15:25	06/12/2020 17:11	06/12/2020 15:25	06/12/2020 17:11	1,76	21	36,99	CHI
20201227066	MONTIVIDIU	MV21092246	MONTIVIDIU T	06/12/2020 15:26	06/12/2020 17:08	06/12/2020 15:26	06/12/2020 17:08	1,69	6	10,16	CHI
20201228033	COCALZINHO DE GOIAS	ZN12297582	COCALZINHO	06/12/2020 15:29	07/12/2020 10:44	06/12/2020 15:29	07/12/2020 10:44	19,24	2	38,49	CHI
20201227431	CRISTALINA	KR12383045	CRISTALINA S2	06/12/2020 15:30	06/12/2020 18:14	06/12/2020 15:30	06/12/2020 18:14	2,72	12	32,62	CHI
20201229339	MORRO AGUDO DE GOIAS	MS12246464	ITAPURANGA	06/12/2020 15:30	07/12/2020 08:05	06/12/2020 15:30	07/12/2020 08:05	16,58	7	116,08	CHI
20201227096	ANICUNS	AC11000006	ANICUNS	06/12/2020 15:31	06/12/2020 16:42	06/12/2020 15:31	06/12/2020 16:42	1,17	119	139,73	CHI
20201227355	GOIATUBA	JV12161205	BOM JESUS DE GOIAS	06/12/2020 15:32	07/12/2020 00:18	06/12/2020 15:32	07/12/2020 00:18	8,76	3	26,29	CHI
20201227108	JATAI	JT21184069	MONTIVIDIU T	06/12/2020 15:34	06/12/2020 20:09	06/12/2020 15:34	06/12/2020 20:09	4,57	1	4,57	CHI
20201227120	ITABERAI	IB12210550	ITABERAI S1	06/12/2020 15:36	07/12/2020 08:11	06/12/2020 15:36	07/12/2020 08:11	16,58	34	563,61	CHI
20201227120	GOIAS	IB12210550	ITABERAI S1	06/12/2020 15:36	07/12/2020 08:11	06/12/2020 15:36	07/12/2020 08:11	16,58	2	33,15	CHI
20201227375	SAO LUIZ DO NORTE	SZ13415896B	BARRO ALTO	06/12/2020 15:36	07/12/2020 12:40	06/12/2020 15:36	07/12/2020 12:15	20,64	56	1155,86	CHI
20201227375	SAO LUIZ DO NORTE	SZ12332178	BARRO ALTO	06/12/2020 15:36	07/12/2020 12:40	06/12/2020 15:36	07/12/2020 12:40	21,06	26	547,49	CHI
20201227131	BELA VISTA DE GOIAS	BV21238105	BELA VISTA S2	06/12/2020 15:37	06/12/2020 17:15	06/12/2020 15:37	06/12/2020 17:15	1,63	1	1,63	CHI
20201227132	APARECIDA DE GOIANIA	10003660034	INDEPENDENCIA S2	06/12/2020 15:37	06/12/2020 20:18	06/12/2020 15:37	06/12/2020 20:18	4,68	1	4,68	CHI
20201227138	ITAPACI	IW12046341	ITAPACI	06/12/2020 15:38	06/12/2020 17:15	06/12/2020 15:38	06/12/2020 17:15	1,61	3	4,83	CHI
20201227143	ALEXANIA	AX21144131	ALEXANIA	06/12/2020 15:39	06/12/2020 23:16	06/12/2020 15:39	06/12/2020 23:16	7,62	2	15,23	CHI
20201227149	FAINA	FC12274318	GOIAS	06/12/2020 15:40	06/12/2020 21:40	06/12/2020 15:40	06/12/2020 21:40	5,99	20	119,81	CHI
20201227153	JESUPOLIS	SF12050004	SAO FRANCISCO DE GOIAS	06/12/2020 15:41	07/12/2020 14:53	06/12/2020 15:41	07/12/2020 14:53	23,20	4	92,78	CHI
20201227160	SAO DOMINGOS	SD12132214	SAO DOMINGOS	06/12/2020 15:41	06/12/2020 16:40	06/12/2020 15:41	06/12/2020 16:40	0,98	3	2,93	CHI
20201227569	CAIAPONIA	CP12155495	CAIAPONIA	06/12/2020 15:41	07/12/2020 09:02	06/12/2020 15:41	07/12/2020 09:02	17,34	10	173,42	CHI
20201227174	ARAGUAPAZ	AZ11029340	GOIAS	06/12/2020 15:43	06/12/2020 18:06	06/12/2020 15:43	06/12/2020 18:06	2,37	59	139,68	CHI
20201227185	GOIANIA	10012596262	MEIA PONTE	06/12/2020 15:44	06/12/2020 17:21	06/12/2020 15:44	06/12/2020 17:21	1,61	1	1,61	CHI
20201227870	JARAGUA	JA12221352	JARAGUA	06/12/2020 15:44	06/12/2020 19:12	06/12/2020 15:44	06/12/2020 19:12	3,45	56	193,28	CHI
20201228302	ITAPURANGA	IK12307331	ITAPURANGA	06/12/2020 15:44	07/12/2020 03:31	06/12/2020 15:44	07/12/2020 03:31	11,77	7	82,42	CHI
20201232675	FAINA	FC12299837	GOIAS	06/12/2020 15:44	07/12/2020 11:39	06/12/2020 15:44	07/12/2020 11:39	19,90	7	139,31	CHI
20201227183	ALTO PARAISO DE GOIAS	BF21392367	NIQUELANDIA SUBTRANSMISSAO	06/12/2020 15:45	06/12/2020 18:02	06/12/2020 15:45	06/12/2020 18:02	2,28	1	2,28	CHI
20201227193	RIO VERDE	630357869	RIO VERDE S2	06/12/2020 15:46	06/12/2020 21:31	06/12/2020 15:46	06/12/2020 21:31	5,74	1	5,74	CHI
20201227198	CAMPO LIMPO	AN21380136	NEROPOLIS S1	06/12/2020 15:47	06/12/2020 21:05	06/12/2020 15:47	06/12/2020 21:05	5,29	1	5,29	CHI
20201228427	ARAGUAPAZ	FC12096060	GOIAS	06/12/2020 15:47	06/12/2020 20:39	06/12/2020 15:47	06/12/2020 20:39	4,86	2	9,71	CHI
20201228427	FAINA	FC12096060	GOIAS	06/12/2020 15:47	06/12/2020 20:39	06/12/2020 15:47	06/12/2020 20:39	4,86	124	602,19	CHI
20201224311	PIRES DO RIO	PR21272840	PIRES DO RIO S1	06/12/2020 15:49	06/12/2020 19:54	06/12/2020 15:49	06/12/2020 19:54	4,07	2	8,14	CHI
20201227213	GUAPO	GA21008762	GUAPO S2	06/12/2020 15:50	06/12/2020 20:16	06/12/2020 15:50	06/12/2020 20:16	4,43	1	4,43	CHI
20201227217	NEROPOLIS	10005129050	NEROPOLIS S2	06/12/2020 15:50	06/12/2020 17:16	06/12/2020 15:50	06/12/2020 17:16	1,42	1	1,42	CHI
20201227219	ALEXANIA	10016126198	ALEXANIA	06/12/2020 15:51	07/12/2020 03:54	06/12/2020 15:51	07/12/2020 03:54	12,05	1	12,05	CHI

20201227223	SANTA TEREZINHA DE GOIAS	SG11034165	SANTA TEREZINHA	06/12/2020 15:51	06/12/2020 16:45	06/12/2020 15:51	06/12/2020 16:45	0,90	201	180,06	CHI
20201227225	ARAGARCAS	AG12072894	ARAGARCAS	06/12/2020 15:52	06/12/2020 18:17	06/12/2020 15:52	06/12/2020 18:17	2,41	79	190,78	CHI
20201227225	BOM JARDIM DE GOIAS	AG12072894	ARAGARCAS	06/12/2020 15:52	06/12/2020 18:17	06/12/2020 15:52	06/12/2020 18:17	2,41	35	84,52	CHI
20201227533	MARA ROSA	MQ12059925	MARA ROSA	06/12/2020 15:52	06/12/2020 18:34	06/12/2020 15:52	06/12/2020 18:34	2,69	12	32,34	CHI
20201227243	APARECIDA DO RIO DOCE	7418901	CACHOEIRA ALTA	06/12/2020 15:54	06/12/2020 18:53	06/12/2020 15:54	06/12/2020 18:53	2,97	39	115,86	CHI
20201227243	JATAI	7418901	CACHOEIRA ALTA	06/12/2020 15:54	06/12/2020 18:53	06/12/2020 15:54	06/12/2020 18:53	2,97	8	23,77	CHI
20201229247	JATAI	JT21214505	CACHOEIRA ALTA	06/12/2020 15:54	07/12/2020 12:53	06/12/2020 15:54	07/12/2020 12:53	20,98	1	20,98	CHI
20201227252	ANAPOLIS	AN11019594	ANAPOLIS UNIVERSITARIO S2	06/12/2020 15:55	06/12/2020 18:19	06/12/2020 15:55	06/12/2020 18:19	2,39	42	100,41	CHI
20201227253	TROMBAS	TB11288319	PORANGATU	06/12/2020 15:55	08/12/2020 01:12	06/12/2020 15:55	08/12/2020 01:12	33,27	1	33,27	CHI
20201227258	SANTO ANTONIO DA BARRA	RV21106351	ACREUNA	06/12/2020 15:56	07/12/2020 08:20	06/12/2020 15:56	07/12/2020 08:20	16,39	1	16,39	CHI
20201227259	LUZIANIA	120304326	RIO VERMELHO	06/12/2020 15:56	06/12/2020 23:21	06/12/2020 15:56	06/12/2020 23:21	7,40	1	7,40	CHI
20201227452	PIRENOPOLIS	JA12273331	JARAGUA	06/12/2020 15:56	06/12/2020 21:01	06/12/2020 15:56	06/12/2020 21:01	5,07	29	146,98	CHI
20201227452	JARAGUA	JA12273331	JARAGUA	06/12/2020 15:56	06/12/2020 21:01	06/12/2020 15:56	06/12/2020 21:01	5,07	15	76,02	CHI
20201227263	APARECIDA DE GOIANIA	200060480	INDEPENDENCIA S1	06/12/2020 15:57	07/12/2020 21:04	06/12/2020 15:57	07/12/2020 21:04	29,12	1	29,12	CHI
20201227269	PIRENOPOLIS	PV11344548	CORUMBA	06/12/2020 15:58	06/12/2020 23:15	06/12/2020 15:58	06/12/2020 23:15	7,27	17	123,64	CHI
20201227275	CALDAS NOVAS	10029419431	SERRA DE CALDAS	06/12/2020 15:59	06/12/2020 17:50	06/12/2020 15:59	06/12/2020 17:50	1,84	1	1,84	CHI
20201227868	PETROLINA DE GOIAS	PG12097009	SAO FRANCISCO DE GOIAS	06/12/2020 15:59	06/12/2020 23:05	06/12/2020 15:59	06/12/2020 23:05	7,10	23	163,22	CHI
20201229334	SANTA TEREZINHA DE GOIAS	SG12202092	SANTA TEREZINHA	06/12/2020 15:59	07/12/2020 07:36	06/12/2020 15:59	07/12/2020 07:36	15,61	6	93,66	CHI
20201227278	ALEXANIA	AX21144013	ALEXANIA	06/12/2020 16:00	06/12/2020 17:36	06/12/2020 16:00	06/12/2020 17:36	1,60	1	1,60	CHI
20201227279	CAMPOS BELOS	CH12211504	SAO DOMINGOS	06/12/2020 16:00	06/12/2020 17:39	06/12/2020 16:00	06/12/2020 17:39	1,65	5	8,24	CHI
20201227284	CRIXAS	CX12190130	SANTA TEREZINHA	06/12/2020 16:00	07/12/2020 08:44	06/12/2020 16:00	07/12/2020 08:44	16,72	7	117,07	CHI
20201227285	PARAUNA	PU21045074	ACREUNA	06/12/2020 16:00	06/12/2020 17:06	06/12/2020 16:00	06/12/2020 17:06	1,09	1	1,09	CHI
20201227286	PARAUNA	PU21237780	PALMEIRAS	06/12/2020 16:00	06/12/2020 21:17	06/12/2020 16:00	06/12/2020 21:17	5,27	1	5,27	CHI
20201228233	MUTUNOPOLIS	MU12086704	MARA ROSA	06/12/2020 16:00	06/12/2020 22:49	06/12/2020 16:00	06/12/2020 22:49	6,81	5	34,04	CHI
20201230367	SANTA TEREZINHA DE GOIAS	GG12171805RE	SANTA TEREZINHA	06/12/2020 16:00	07/12/2020 08:13	06/12/2020 16:00	07/12/2020 08:13	16,20	47	761,57	CHI
20201230367	PILAR DE GOIAS	GG12171805RE	SANTA TEREZINHA	06/12/2020 16:00	07/12/2020 08:13	06/12/2020 16:00	07/12/2020 08:13	16,20	60	972,22	CHI
20201227295	PIRES DO RIO	OZ21236970	PIRES DO RIO S2	06/12/2020 16:02	06/12/2020 18:44	06/12/2020 16:02	06/12/2020 18:44	2,69	1	2,69	CHI
20201227617	CAIAPONIA	CP12119577	CAIAPONIA	06/12/2020 16:02	07/12/2020 22:08	06/12/2020 16:02	07/12/2020 22:08	30,09	67	2016,23	CHI
20201227617	DOVERLANDIA	CP12119577	CAIAPONIA	06/12/2020 16:02	07/12/2020 22:08	06/12/2020 16:02	07/12/2020 22:08	30,09	7	210,65	CHI
20201227824	TRINDADE	TR12169662	TRINDADE	06/12/2020 16:02	06/12/2020 21:16	06/12/2020 16:02	06/12/2020 21:16	5,22	221	1154,11	CHI
20201229368	JARAGUA	JA12033436	JARAGUA	06/12/2020 16:02	07/12/2020 00:11	06/12/2020 16:02	07/12/2020 00:11	8,15	18	146,67	CHI
20201227302	ALEXANIA	AX11359359	ALEXANIA	06/12/2020 16:03	07/12/2020 10:40	06/12/2020 16:03	07/12/2020 10:40	18,61	36	669,90	CHI
20201227328	PIRACANJUBA	PJ12352525	PIRACANJUBA	06/12/2020 16:04	06/12/2020 20:50	06/12/2020 16:04	06/12/2020 20:50	4,76	16	76,08	CHI
20201227315	LUZIANIA	3200134328	MARAJOARA	06/12/2020 16:05	06/12/2020 18:25	06/12/2020 16:05	06/12/2020 18:25	2,32	1	2,32	CHI
20201227316	LUZIANIA	120277451	RIO VERMELHO	06/12/2020 16:05	06/12/2020 22:12	06/12/2020 16:05	06/12/2020 22:12	6,10	1	6,10	CHI
20201227317	PIRACANJUBA	PJ21352518	PIRACANJUBA	06/12/2020 16:06	07/12/2020 22:51	06/12/2020 16:06	07/12/2020 22:51	30,75	1	30,75	CHI
20201227676	JESUPOLIS	SR12130200	INHUMAS S1	06/12/2020 16:06	07/12/2020 00:42	06/12/2020 16:06	07/12/2020 00:42	8,59	15	128,86	CHI
20201227324	AGUAS LINDAS DE GOIAS	SN12117003	AGUAS LINDAS DE GOIAS S1	06/12/2020 16:07	06/12/2020 17:20	06/12/2020 16:07	06/12/2020 17:20	1,21	7	8,46	CHI
20201227326	NOVA AURORA	NE21239761	CATALAO S1	06/12/2020 16:07	06/12/2020 18:22	06/12/2020 16:07	06/12/2020 18:22	2,24	1	2,24	CHI
20201228691	AGUA FRIA DE GOIAS	TL12394158	SAO JOAO D ALIANCA	06/12/2020 16:08	06/12/2020 22:12	06/12/2020 16:08	06/12/2020 22:12	6,06	16	96,91	CHI
20201227707	COCALZINHO DE GOIAS	ZN12000096	COCALZINHO	06/12/2020 16:09	06/12/2020 21:30	06/12/2020 16:09	06/12/2020 21:30	5,34	24	128,27	CHI
20201227826	SAO LUIZ DO NORTE	SZ12243709	ITAPACI	06/12/2020 16:09	06/12/2020 19:26	06/12/2020 16:09	06/12/2020 19:26	3,28	47	153,99	CHI
20201227826	NOVA GLORIA	SZ12243709	ITAPACI	06/12/2020 16:09	06/12/2020 19:26	06/12/2020 16:09	06/12/2020 19:26	3,28	1	3,28	CHI
20201227826	ITAPACI	SZ12243709	ITAPACI	06/12/2020 16:09	06/12/2020 19:26	06/12/2020 16:09	06/12/2020 19:26	3,28	3	9,83	CHI
20201227076	PIRENOPOLIS	PV13275565	CORUMBA	06/12/2020 16:10	06/12/2020 22:45	06/12/2020 16:10	06/12/2020 22:45	6,57	58	381,24	CHI
20201227076	VILA PROPICIO	PV13275565	CORUMBA	06/12/2020 16:10	06/12/2020 22:45	06/12/2020 16:10	06/12/2020 22:45	6,57	3	19,72	CHI
20201227076	JARAGUA	PV13275565	CORUMBA	06/12/2020 16:10	06/12/2020 22:45	06/12/2020 16:10	06/12/2020 22:45	6,57	4	26,29	CHI
20201227076	GOIANESIA	PV13275565	CORUMBA	06/12/2020 16:10	06/12/2020 22:45	06/12/2020 16:10	06/12/2020 22:45	6,57	11	72,30	CHI
20201227076	PIRENOPOLIS	PV13275565	CORUMBA	06/12/2020 16:10	06/12/2020 22:45	06/12/2020 19:40	06/12/2020 22:45	3,08	202	622,78	CHI
20201227346	ARAGUAPAZ	AZ12198854	GOIAS	06/12/2020 16:10	06/12/2020 17:31	06/12/2020 16:10	06/12/2020 17:31	1,34	11	14,71	CHI
20201227350	RIO VERDE	630040333	RIO VERDE S1	06/12/2020 16:11	06/12/2020 21:40	06/12/2020 16:11	06/12/2020 21:40	5,47	1	5,47	CHI

20201227530	SANTO ANTONIO DA BARRA	01690214	ACREUNA	06/12/2020 16:35	08/12/2020 15:00	07/12/2020 13:49	07/12/2020 14:04	0,25	1652	419,42	CHI
20201227530	RIO VERDE	01690214	ACREUNA	06/12/2020 16:35	08/12/2020 15:00	07/12/2020 13:49	07/12/2020 14:04	0,25	42	10,66	CHI
20201227530	SANTO ANTONIO DA BARRA	B210407791	ACREUNA	06/12/2020 16:35	08/12/2020 15:00	06/12/2020 16:35	08/12/2020 13:30	44,91	8	359,30	CHI
20201227530	SANTO ANTONIO DA BARRA	BZ1200006LD	ACREUNA	06/12/2020 16:35	08/12/2020 15:00	06/12/2020 16:36	08/12/2020 13:53	45,29	1	45,29	CHI
20201227530	RIO VERDE	BZ13400197B	ACREUNA	06/12/2020 16:35	08/12/2020 15:00	06/12/2020 16:36	08/12/2020 13:53	45,29	1	45,29	CHI
20201227530	PARAUNA	BZ13400197B	ACREUNA	06/12/2020 16:35	08/12/2020 15:00	06/12/2020 19:00	08/12/2020 13:53	42,89	7	300,24	CHI
20201227530	SANTO ANTONIO DA BARRA	BZ13400197B	ACREUNA	06/12/2020 16:35	08/12/2020 15:00	08/12/2020 14:30	08/12/2020 15:00	0,51	4	2,04	CHI
20201227530	PARAUNA	BZ13400197B	ACREUNA	06/12/2020 16:35	08/12/2020 15:00	08/12/2020 14:30	08/12/2020 15:00	0,51	166	84,61	CHI
20201227530	RIO VERDE	BZ13400197B	ACREUNA	06/12/2020 16:35	08/12/2020 15:00	08/12/2020 14:30	08/12/2020 15:00	0,51	98	49,95	CHI
20201227538	GOIANIA	14986589	MEIA PONTE	06/12/2020 16:35	06/12/2020 18:43	06/12/2020 16:35	06/12/2020 18:43	2,12	1	2,12	CHI
20201227534	CRISTALINA	KR11276354	CRISTALINA S1	06/12/2020 16:37	07/12/2020 11:15	06/12/2020 16:37	07/12/2020 11:15	18,63	167	3110,51	CHI
20201227536	APARECIDA DE GOIANIA	AP11345614	CEPAIGO S1	06/12/2020 16:37	06/12/2020 20:44	06/12/2020 16:37	06/12/2020 20:44	4,10	165	676,55	CHI
20201228687	FAINA	FC12307346	GOIAS	06/12/2020 16:37	06/12/2020 23:05	06/12/2020 16:37	06/12/2020 23:05	6,47	24	155,19	CHI
20201227542	CATALAO	1990183971	CATALAO S2	06/12/2020 16:38	06/12/2020 18:43	06/12/2020 16:38	06/12/2020 18:43	2,07	1	2,07	CHI
20201227545	GOIANIA	17377948	MEIA PONTE	06/12/2020 16:38	06/12/2020 18:10	06/12/2020 16:38	06/12/2020 18:10	1,52	1	1,52	CHI
20201228057	CRISTALINA	KR12165873	CRISTALINA S2	06/12/2020 16:41	06/12/2020 20:47	06/12/2020 16:41	06/12/2020 20:47	4,09	17	69,61	CHI
20201227557	JARAGUA	JA21027411	SAO FRANCISCO DE GOIAS	06/12/2020 16:42	07/12/2020 01:26	06/12/2020 16:42	07/12/2020 01:26	8,73	2	17,47	CHI
20201227564	ANAPOLIS	AN31037461	NEROPOLIS S1	06/12/2020 16:42	07/12/2020 01:10	06/12/2020 16:42	07/12/2020 01:10	8,47	1	8,47	CHI
20201227598	GUAPO	01760424	TRINDADE	06/12/2020 16:42	07/12/2020 16:31	06/12/2020 16:42	06/12/2020 18:02	1,33	21	28,02	CHI
20201227598	TRINDADE	01760424	TRINDADE	06/12/2020 16:42	07/12/2020 16:31	06/12/2020 16:42	06/12/2020 18:02	1,33	486	648,41	CHI
20201227598	CAMPESTRE DE GOIAS	01760424	TRINDADE	06/12/2020 16:42	07/12/2020 16:31	06/12/2020 16:42	06/12/2020 18:02	1,33	1413	1885,18	CHI
20201227598	PALMEIRAS DE GOIAS	01760424	TRINDADE	06/12/2020 16:42	07/12/2020 16:31	06/12/2020 16:42	06/12/2020 18:02	1,33	1	1,33	CHI
20201227598	CAMPESTRE DE GOIAS	01760424	TRINDADE	06/12/2020 16:42	07/12/2020 16:31	06/12/2020 16:42	06/12/2020 18:02	1,33	7	9,34	CHI
20201227598	SANTA BARBARA DE GOIAS	01760424	TRINDADE	06/12/2020 16:42	07/12/2020 16:31	06/12/2020 16:42	06/12/2020 18:02	1,33	11	14,68	CHI
20201227598	ABADIA DE GOIAS	01760424	TRINDADE	06/12/2020 16:42	07/12/2020 16:31	06/12/2020 16:42	06/12/2020 18:02	1,33	9	12,01	CHI
20201227598	PALMEIRAS DE GOIAS	01760424	TRINDADE	06/12/2020 16:42	07/12/2020 16:31	06/12/2020 16:42	06/12/2020 18:02	1,33	13	17,34	CHI
20201227598	TRINDADE	01760424	TRINDADE	06/12/2020 16:42	07/12/2020 16:31	06/12/2020 16:42	06/12/2020 18:02	1,33	93	124,08	CHI
20201227598	TRINDADE	01760424	TRINDADE	06/12/2020 16:42	07/12/2020 16:31	06/12/2020 16:42	06/12/2020 18:46	2,07	46	95,04	CHI
20201227598	TRINDADE	01760424	TRINDADE	06/12/2020 16:42	07/12/2020 16:31	06/12/2020 16:43	06/12/2020 18:46	2,06	2	4,11	CHI
20201227598	TRINDADE	01760424	TRINDADE	06/12/2020 16:42	07/12/2020 16:31	06/12/2020 18:00	06/12/2020 18:46	0,76	1	0,76	CHI
20201227598	TRINDADE	01760424	TRINDADE	06/12/2020 16:42	07/12/2020 16:31	06/12/2020 16:42	07/12/2020 15:02	22,33	2	44,66	CHI
20201227598	TRINDADE	00750414	TRINDADE	06/12/2020 16:42	07/12/2020 16:31	07/12/2020 16:26	07/12/2020 16:31	0,08	486	38,61	CHI
20201227598	CAMPESTRE DE GOIAS	TR13337922	TRINDADE	06/12/2020 16:42	07/12/2020 16:31	07/12/2020 16:26	07/12/2020 16:31	0,08	7	0,56	CHI
20201227598	SANTA BARBARA DE GOIAS	00750414	TRINDADE	06/12/2020 16:42	07/12/2020 16:31	07/12/2020 16:26	07/12/2020 16:31	0,08	11	0,87	CHI
20201227598	CAMPESTRE DE GOIAS	00750414	TRINDADE	06/12/2020 16:42	07/12/2020 16:31	07/12/2020 16:26	07/12/2020 16:31	0,08	1414	112,33	CHI
20201227598	TRINDADE	TR13337922	TRINDADE	06/12/2020 16:42	07/12/2020 16:31	07/12/2020 16:26	07/12/2020 16:31	0,08	93	7,39	CHI
20201227598	GUAPO	TR13337922	TRINDADE	06/12/2020 16:42	07/12/2020 16:31	07/12/2020 16:26	07/12/2020 16:31	0,08	21	1,67	CHI
20201227598	ABADIA DE GOIAS	TR13337922	TRINDADE	06/12/2020 16:42	07/12/2020 16:31	07/12/2020 16:26	07/12/2020 16:31	0,08	9	0,71	CHI
20201227598	PALMEIRAS DE GOIAS	TR13337922	TRINDADE	06/12/2020 16:42	07/12/2020 16:31	07/12/2020 16:26	07/12/2020 16:31	0,08	1	0,08	CHI
20201227598	PALMEIRAS DE GOIAS	00750414	TRINDADE	06/12/2020 16:42	07/12/2020 16:31	07/12/2020 16:26	07/12/2020 16:31	0,08	13	1,03	CHI
20201226632	SAO DOMINGOS	SD12250983LD	SAO DOMINGOS	06/12/2020 16:43	06/12/2020 17:57	06/12/2020 16:43	06/12/2020 17:57	1,23	23	28,39	CHI
20201227574	FAINA	FC12376699	GOIAS	06/12/2020 16:43	08/12/2020 02:04	06/12/2020 16:43	07/12/2020 22:52	30,15	23	693,38	CHI
20201227574	FAINA	FC12376699	GOIAS	06/12/2020 16:43	08/12/2020 02:04	06/12/2020 16:43	08/12/2020 02:04	33,35	4	133,39	CHI
20201227574	GOIAS	FC12376699	GOIAS	06/12/2020 16:43	08/12/2020 02:04	06/12/2020 16:43	08/12/2020 02:04	33,35	2	66,70	CHI
20201227574	FAINA	FC12376699	GOIAS	06/12/2020 16:43	08/12/2020 02:04	07/12/2020 23:11	08/12/2020 02:04	2,88	23	66,28	CHI
20201227763	PIRENOPOLIS	PV12316020	CORUMBA	06/12/2020 16:43	07/12/2020 10:19	06/12/2020 16:43	07/12/2020 10:19	17,59	14	246,31	CHI
20201227585	GOIANIA	11816193	CAMPINAS S2	06/12/2020 16:44	06/12/2020 18:30	06/12/2020 16:44	06/12/2020 18:30	1,76	1	1,76	CHI
20201227588	PIRENOPOLIS	PV12381210	CORUMBA	06/12/2020 16:45	06/12/2020 21:33	06/12/2020 16:45	06/12/2020 21:33	4,80	10	48,00	CHI
20201227590	COCALZINHO DE GOIAS	9970013184	AGUAS LINDAS DE GOIAS S2	06/12/2020 16:45	06/12/2020 21:46	06/12/2020 16:45	06/12/2020 21:46	5,02	1	5,02	CHI
20201229379	TRINDADE	TR16414822	TRINDADE	06/12/2020 16:45	07/12/2020 01:40	07/12/2020 01:21	07/12/2020 01:40	0,32	528	169,11	CHI
20201227605	CRISTALINA	KR12184821	CRISTALINA S2	06/12/2020 16:47	07/12/2020 00:54	06/12/2020 16:47	07/12/2020 00:54	8,11	4	32,43	CHI

20201229263	PIRENOPOLIS	PV12381249	CORUMBA	06/12/2020 17:07	06/12/2020 21:34	06/12/2020 17:07	06/12/2020 21:34	4,45	6	26,70	CHI
20201227855	PIRENOPOLIS	ZN12326323	COCALZINHO	06/12/2020 17:08	06/12/2020 23:03	06/12/2020 17:08	06/12/2020 23:03	5,91	31	183,11	CHI
20201227855	COCALZINHO DE GOIAS	ZN12326323	COCALZINHO	06/12/2020 17:08	06/12/2020 23:03	06/12/2020 17:08	06/12/2020 23:03	5,91	7	41,35	CHI
20201227765	MAURILANDIA	CL12306027	RIO DOS BOIS	06/12/2020 17:09	08/12/2020 22:51	06/12/2020 17:09	08/12/2020 22:51	53,69	5	268,47	CHI
20201227765	PORTEIRAO	CL12306027	RIO DOS BOIS	06/12/2020 17:09	08/12/2020 22:51	06/12/2020 17:09	08/12/2020 22:51	53,69	3	161,08	CHI
20201227770	GOIANESIA	10002674600	GOIANESIA S2	06/12/2020 17:10	06/12/2020 21:04	06/12/2020 17:10	06/12/2020 21:04	3,89	1	3,89	CHI
20201227860	BELA VISTA DE GOIAS	BV12009000	BELA VISTA S2	06/12/2020 17:10	06/12/2020 22:06	06/12/2020 17:10	06/12/2020 22:06	4,92	56	275,50	CHI
2020120600120	MOZARLANDIA	MOZ-TR1	MOZARLANDIA	06/12/2020 17:10	06/12/2020 19:55	06/12/2020 19:38	06/12/2020 19:55	0,29	871	253,56	CHI
2020120600120	CRIXAS	MOZ-TR1	MOZARLANDIA	06/12/2020 17:10	06/12/2020 19:55	06/12/2020 19:38	06/12/2020 19:55	0,29	103	29,98	CHI
2020120600120	MOZARLANDIA	MOZ-TR1	MOZARLANDIA	06/12/2020 17:10	06/12/2020 19:55	06/12/2020 19:38	06/12/2020 19:55	0,29	4937	1437,22	CHI
2020120600120	NOVA CRIXAS	MOZ-TR1	MOZARLANDIA	06/12/2020 17:10	06/12/2020 19:55	06/12/2020 19:38	06/12/2020 19:55	0,29	35	10,19	CHI
2020120600120	ARAGUAPAZ	MOZ-TR1	RUBIATABA	06/12/2020 17:10	06/12/2020 19:55	06/12/2020 19:38	06/12/2020 19:55	0,29	81	23,58	CHI
2020120600120	ARAGUAPAZ	MOZ-TR1	MOZARLANDIA	06/12/2020 17:10	06/12/2020 19:55	06/12/2020 19:38	06/12/2020 19:55	0,29	36	10,48	CHI
2020120600120	ARAGUAPAZ	MOZ-TR1	MOZARLANDIA	06/12/2020 17:10	06/12/2020 19:55	06/12/2020 19:38	06/12/2020 19:55	0,29	2858	832,00	CHI
2020120600120	MOZARLANDIA	MOZ-TR1	MOZARLANDIA	06/12/2020 17:10	06/12/2020 19:55	06/12/2020 19:38	06/12/2020 19:55	0,29	10	2,91	CHI
2020120600120	ARUANA	MOZ-TR1	MOZARLANDIA	06/12/2020 17:10	06/12/2020 19:55	06/12/2020 19:38	06/12/2020 19:55	0,29	8	2,33	CHI
2020120600120	CRIXAS	MOZ-TR1	RUBIATABA	06/12/2020 17:10	06/12/2020 19:55	06/12/2020 19:38	06/12/2020 19:55	0,29	541	157,49	CHI
2020120600120	MOZARLANDIA	MOZ-TR1	RUBIATABA	06/12/2020 17:10	06/12/2020 19:55	06/12/2020 19:38	06/12/2020 19:55	0,29	4	1,16	CHI
2020120600120	MOZARLANDIA	MOZ-TR1	MOZARLANDIA	06/12/2020 17:10	06/12/2020 19:55	06/12/2020 19:38	06/12/2020 19:55	0,29	349	101,60	CHI
2020120600120	MATRINCHA	MOZ-TR1	MOZARLANDIA	06/12/2020 17:10	06/12/2020 19:55	06/12/2020 19:38	06/12/2020 19:55	0,29	42	12,23	CHI
2020120600120	NOVA CRIXAS	MOZ-TR1	MOZARLANDIA	06/12/2020 17:10	06/12/2020 19:55	06/12/2020 19:38	06/12/2020 19:55	0,29	33	9,61	CHI
2020120600120	NOVA CRIXAS	MOZ-TR1	RUBIATABA	06/12/2020 17:10	06/12/2020 19:55	06/12/2020 19:38	06/12/2020 19:55	0,29	1	0,29	CHI
2020120600120	NOVA CRIXAS	MOZ-TR1	MOZARLANDIA	06/12/2020 17:10	06/12/2020 19:55	06/12/2020 19:38	06/12/2020 19:55	0,29	179	52,11	CHI
2020120600120	MOZARLANDIA	MOZ-TR1	MOZARLANDIA	06/12/2020 17:10	06/12/2020 19:55	06/12/2020 19:38	06/12/2020 19:55	0,29	99	28,82	CHI
2020120600120	ARUANA	MOZ-TR1	MOZARLANDIA	06/12/2020 17:10	06/12/2020 19:55	06/12/2020 19:38	06/12/2020 19:55	0,29	73	21,25	CHI
2020120600120	NOVA IGUACU DE GOIAS	MOZ-TR1	RUBIATABA	06/12/2020 17:10	06/12/2020 19:55	06/12/2020 19:38	06/12/2020 19:55	0,29	1	0,29	CHI
2020120600120	ARUANA	MOZ-TR1	MOZARLANDIA	06/12/2020 17:10	06/12/2020 19:55	06/12/2020 19:38	06/12/2020 19:55	0,29	122	35,52	CHI
2020120600120	MOZARLANDIA	MOZ-TR1	MOZARLANDIA	06/12/2020 17:10	06/12/2020 19:55	06/12/2020 19:38	06/12/2020 19:55	0,29	13	3,78	CHI
2020120600120	MOZARLANDIA	MOZ-TR1	MOZARLANDIA	06/12/2020 17:10	06/12/2020 19:55	06/12/2020 19:38	06/12/2020 19:55	0,29	4	1,16	CHI
20201227775	MAURILANDIA	1040019691	RIO DOS BOIS	06/12/2020 17:11	07/12/2020 10:23	06/12/2020 17:11	07/12/2020 10:23	17,19	1	17,19	CHI
20201228147	GOIANAPOLIS	GP11193112	DAIA S2	06/12/2020 17:11	06/12/2020 20:22	06/12/2020 17:11	06/12/2020 20:22	3,17	73	231,67	CHI
20201228694	MONTES CLAROS DE GOIAS	ME12184484	IPORA	06/12/2020 17:11	07/12/2020 11:30	06/12/2020 17:11	07/12/2020 11:30	18,31	33	604,36	CHI
20201227792	SAO SIMAO	SO11301505	CACHOEIRA ALTA	06/12/2020 17:13	06/12/2020 18:13	06/12/2020 17:13	06/12/2020 18:13	0,99	85	84,41	CHI
20201227798	CAIAPONIA	CP12372014	IPORA	06/12/2020 17:14	07/12/2020 12:31	06/12/2020 17:14	07/12/2020 12:31	19,28	2	38,55	CHI
20201227800	NOVA CRIXAS	NA11386651	NOVA CRIXAS	06/12/2020 17:14	07/12/2020 09:20	06/12/2020 17:14	07/12/2020 09:20	16,09	9	144,77	CHI
20201227801	GOIANIA	10015472530	GOYA S2	06/12/2020 17:14	06/12/2020 19:14	06/12/2020 17:14	06/12/2020 19:14	1,98	1	1,98	CHI
20201227802	APARECIDA DE GOIANIA	15638686	REAL S2	06/12/2020 17:15	06/12/2020 19:46	06/12/2020 17:15	06/12/2020 19:46	2,52	1	2,52	CHI
20201227810	RIO VERDE	10005870079	RIO VERDE S2	06/12/2020 17:17	07/12/2020 02:33	06/12/2020 17:17	07/12/2020 02:33	9,26	1	9,26	CHI
20201227973	APARECIDA DE GOIANIA	AP12312943	REAL S1	06/12/2020 17:18	06/12/2020 19:03	06/12/2020 17:18	06/12/2020 19:03	1,75	1283	2245,25	CHI
20201228209	PARAUNA	PU12079039	PARAUNA	06/12/2020 17:18	06/12/2020 19:54	06/12/2020 17:18	06/12/2020 19:54	2,58	38	98,21	CHI
20201229037	JARAGUA	JA12297901	JARAGUA	06/12/2020 17:18	06/12/2020 22:53	06/12/2020 17:18	06/12/2020 22:53	5,58	19	105,95	CHI
20201227863	AGUA FRIA DE GOIAS	PI12325588	SAO JOAO D ALIANCA	06/12/2020 17:19	06/12/2020 21:18	06/12/2020 17:19	06/12/2020 21:18	3,98	1	3,98	CHI
20201227863	PLANALTINA	PI12325588	SAO JOAO D ALIANCA	06/12/2020 17:19	06/12/2020 21:18	06/12/2020 17:19	06/12/2020 21:18	3,98	103	409,48	CHI
20201228563	COLINAS DO SUL	TI12355503	MINACU	06/12/2020 17:19	06/12/2020 22:08	06/12/2020 17:19	06/12/2020 22:08	4,81	9	43,31	CHI
20201227836	ITAPURANGA	IK21242490	ITAPURANGA	06/12/2020 17:20	06/12/2020 21:37	06/12/2020 17:20	06/12/2020 21:37	4,28	1	4,28	CHI
20201227837	NOVA GLORIA	NG21181399	RUBIATABA	06/12/2020 17:20	06/12/2020 23:38	06/12/2020 17:20	06/12/2020 23:38	6,30	1	6,30	CHI
20201227838	NOVA ROMA	ND12392238	IACIARA S2	06/12/2020 17:20	06/12/2020 19:40	06/12/2020 17:20	06/12/2020 19:40	2,33	244	567,30	CHI
20201228240	PADRE BERNARDO	ZN12342164	PADRE BERNARDO	06/12/2020 17:20	07/12/2020 12:39	06/12/2020 17:20	07/12/2020 12:39	19,31	5	96,54	CHI
20201227702	SIMOLANDIA	SA12246943	IACIARA S2	06/12/2020 17:21	07/12/2020 10:07	06/12/2020 17:21	07/12/2020 10:07	16,75	6	100,52	CHI
20201227843	OURO VERDE DE GOIAS	OV21247162	NEROPOLIS S1	06/12/2020 17:21	06/12/2020 19:49	06/12/2020 17:21	06/12/2020 19:49	2,46	1	2,46	CHI
20201227910	NEROPOLIS	NR12000048	NEROPOLIS S2	06/12/2020 17:21	07/12/2020 10:45	06/12/2020 17:21	06/12/2020 20:47	3,43	8	27,45	CHI

20201228052	GOIANIA	GN21001920	AEROPORTO S3	06/12/2020 17:49	07/12/2020 15:48	07/12/2020 10:27	07/12/2020 15:47	5,34	18	96,06	CHI
20201228052	GOIANIA	GN21000744	AEROPORTO S3	06/12/2020 17:49	07/12/2020 15:48	07/12/2020 12:26	07/12/2020 15:48	3,37	1	3,37	CHI
20201228123	TEREZOPOLIS DE GOIAS	TJ12389754	DAIA S2	06/12/2020 17:49	06/12/2020 19:10	06/12/2020 17:49	06/12/2020 19:10	1,34	20	26,83	CHI
20201228123	GOIANAPOLIS	TJ12389754	DAIA S2	06/12/2020 17:49	06/12/2020 19:10	06/12/2020 17:49	06/12/2020 19:10	1,34	2	2,68	CHI
20201228468	ANAPOLIS	AN12000598	ANAPOLIS UNIVERSITARIO S2	06/12/2020 17:49	06/12/2020 22:22	06/12/2020 17:49	06/12/2020 22:22	4,55	10	45,49	CHI
20201228260	PIRENOPOLIS	PV12000137	CORUMBA	06/12/2020 17:50	06/12/2020 19:40	06/12/2020 17:50	06/12/2020 19:40	1,82	2	3,64	CHI
20201228039	GOIANIA	10005161710	XAVANTES	06/12/2020 17:51	06/12/2020 20:49	06/12/2020 17:51	06/12/2020 20:49	2,96	1	2,96	CHI
2020120600037	CATALAO	CPG-TR1	CAMPO ALEGRE DE GOIAS	06/12/2020 17:51	06/12/2020 18:05	06/12/2020 18:00	06/12/2020 18:05	0,09	59	5,15	CHI
2020120600037	CATALAO	CPG-TR1	CAMPO ALEGRE DE GOIAS	06/12/2020 17:51	06/12/2020 18:05	06/12/2020 18:00	06/12/2020 18:05	0,09	21	1,83	CHI
2020120600037	ORIZONA	CPG-TR1	PIRES DO RIO S2	06/12/2020 17:51	06/12/2020 18:05	06/12/2020 18:00	06/12/2020 18:05	0,09	1	0,09	CHI
2020120600037	CAMPO ALEGRE DE GOIAS	CPG-TR1	PIRES DO RIO S2	06/12/2020 17:51	06/12/2020 18:05	06/12/2020 18:00	06/12/2020 18:05	0,09	19	1,66	CHI
2020120600037	CAMPO ALEGRE DE GOIAS	CPG-TR1	CAMPO ALEGRE DE GOIAS	06/12/2020 17:51	06/12/2020 18:05	06/12/2020 18:00	06/12/2020 18:05	0,09	234	20,41	CHI
2020120600037	CATALAO	CPG-TR1	CAMPO ALEGRE DE GOIAS	06/12/2020 17:51	06/12/2020 18:05	06/12/2020 18:00	06/12/2020 18:05	0,09	16	1,40	CHI
2020120600037	DISTRITO FEDERAL	CPG-TR1	CAMPO ALEGRE DE GOIAS	06/12/2020 17:51	06/12/2020 18:05	06/12/2020 18:00	06/12/2020 18:05	0,09	1	0,09	CHI
2020120600037	CAMPO ALEGRE DE GOIAS	CPG-TR1	CAMPO ALEGRE DE GOIAS	06/12/2020 17:51	06/12/2020 18:05	06/12/2020 18:00	06/12/2020 18:05	0,09	370	32,27	CHI
2020120600037	IPAMERI	CPG-TR1	PIRES DO RIO S2	06/12/2020 17:51	06/12/2020 18:05	06/12/2020 18:00	06/12/2020 18:05	0,09	268	23,38	CHI
2020120600037	URUTAI	CPG-TR1	PIRES DO RIO S2	06/12/2020 17:51	06/12/2020 18:05	06/12/2020 18:00	06/12/2020 18:05	0,09	6	0,52	CHI
2020120600037	IPAMERI	CPG-TR1	CAMPO ALEGRE DE GOIAS	06/12/2020 17:51	06/12/2020 18:05	06/12/2020 18:00	06/12/2020 18:05	0,09	16	1,40	CHI
2020120600037	IPAMERI	CPG-TR1	CAMPO ALEGRE DE GOIAS	06/12/2020 17:51	06/12/2020 18:05	06/12/2020 18:00	06/12/2020 18:05	0,09	112	9,77	CHI
2020120600037	CAMPO ALEGRE DE GOIAS	CPG-TR1	CAMPO ALEGRE DE GOIAS	06/12/2020 17:51	06/12/2020 18:05	06/12/2020 18:00	06/12/2020 18:05	0,09	2618	228,35	CHI
2020120600037	CAMPO ALEGRE DE GOIAS	CPG-TR1	CAMPO ALEGRE DE GOIAS	06/12/2020 17:51	06/12/2020 18:05	06/12/2020 18:02	06/12/2020 18:05	0,06	1	0,06	CHI
20201228059	PIRACANJUBA	PJ21265201	CRISTIANOPOLIS	06/12/2020 17:54	06/12/2020 20:54	06/12/2020 17:54	06/12/2020 20:54	2,99	2	5,98	CHI
20201228061	EDEIA	1120024514	EDEIA	06/12/2020 17:54	06/12/2020 23:23	06/12/2020 17:54	06/12/2020 23:23	5,47	1	5,47	CHI
20201228081	COCALZINHO DE GOIAS	ZN21157248	AGUAS LINDAS DE GOIAS S1	06/12/2020 17:56	06/12/2020 20:52	06/12/2020 17:56	06/12/2020 20:52	2,92	1	2,92	CHI
20201228084	SANTA TEREZINHA DE GOIAS	SG12156648	SANTA TEREZINHA	06/12/2020 17:57	07/12/2020 15:04	06/12/2020 17:57	07/12/2020 15:04	21,11	2	42,22	CHI
20201228099	JATAI	JT21134917	JATAI S1	06/12/2020 17:57	06/12/2020 20:46	06/12/2020 17:57	06/12/2020 20:46	2,80	1	2,80	CHI
20201228104	INDIARA	IY12301615	ACREUNA	06/12/2020 17:57	06/12/2020 18:43	06/12/2020 17:57	06/12/2020 18:43	0,76	3	2,28	CHI
20201228103	ALEXANIA	10019270559	ALEXANIA	06/12/2020 17:58	07/12/2020 04:44	06/12/2020 17:58	07/12/2020 04:44	10,77	1	10,77	CHI
20201228106	DOVERLANDIA	DV21342643	CAIAPONIA	06/12/2020 17:58	07/12/2020 15:58	06/12/2020 17:58	07/12/2020 15:58	21,99	2	43,98	CHI
20201228108	GOIANESIA	GE21357118	GOIANESIA S2	06/12/2020 17:59	07/12/2020 10:16	06/12/2020 17:59	07/12/2020 10:16	16,29	1	16,29	CHI
20201228109	SAO JOAO D ALIANCA	JL21342381	SAO JOAO D ALIANCA	06/12/2020 17:59	06/12/2020 21:25	06/12/2020 17:59	06/12/2020 21:25	3,43	1	3,43	CHI
20201229826	MINACU	IH12052624	MINACU	06/12/2020 17:59	07/12/2020 15:03	06/12/2020 17:59	07/12/2020 15:03	21,05	15	315,82	CHI
20201228121	PADRE BERNARDO	PB12261461	PADRE BERNARDO	06/12/2020 18:00	06/12/2020 19:26	06/12/2020 18:00	06/12/2020 19:26	1,42	287	407,54	CHI
20201228136	SANTO ANTONIO DO DESCOBERTO	SN21128306	ALEXANIA	06/12/2020 18:02	07/12/2020 10:49	06/12/2020 18:02	07/12/2020 10:49	16,77	1	16,77	CHI
20201228137	DISTRITO FEDERAL	KR12163676RE	PAMPLONA	06/12/2020 18:03	07/12/2020 06:26	06/12/2020 18:03	07/12/2020 06:26	12,38	2	24,76	CHI
20201228137	CRISTALINA	KR12163676RE	PAMPLONA	06/12/2020 18:03	07/12/2020 06:26	06/12/2020 18:03	07/12/2020 06:26	12,38	27	334,24	CHI
20201228137	LUZIANIA	KR12163676RE	PAMPLONA	06/12/2020 18:03	07/12/2020 06:26	06/12/2020 18:03	07/12/2020 06:26	12,38	2	24,76	CHI
20201228140	SANTA CRUZ DE GOIAS	BC11389826	PIRES DO RIO S2	06/12/2020 18:03	07/12/2020 05:04	06/12/2020 18:03	07/12/2020 05:04	11,00	50	550,14	CHI
20201228141	CATURAI	CK12018929	INHUMAS S1	06/12/2020 18:03	06/12/2020 20:27	06/12/2020 18:03	06/12/2020 20:27	2,39	5	11,94	CHI
20201228842	CRISTALINA	KR21184982	PAMPLONA	06/12/2020 18:03	07/12/2020 09:01	06/12/2020 18:03	07/12/2020 09:01	14,96	1	14,96	CHI
20201228158	PIRENOPOLIS	PV12392221	CORUMBA	06/12/2020 18:04	06/12/2020 21:00	06/12/2020 18:04	06/12/2020 21:00	2,92	36	105,12	CHI
20201228155	MINEIROS	MY21322106	PARQUE DAS EMAS	06/12/2020 18:05	06/12/2020 23:09	06/12/2020 18:05	06/12/2020 23:09	5,07	1	5,07	CHI
20201228171	RIO VERDE	RV12360999	CABRIUVA S1	06/12/2020 18:05	06/12/2020 19:21	06/12/2020 18:05	06/12/2020 19:21	1,26	158	198,73	CHI
20201228353	JARAGUA	GE12006564	GOIANESIA S2	06/12/2020 18:05	07/12/2020 08:02	06/12/2020 18:05	07/12/2020 08:02	13,93	2	27,87	CHI
20201228353	PIRENOPOLIS	GE12006564	GOIANESIA S2	06/12/2020 18:05	07/12/2020 08:02	06/12/2020 18:05	07/12/2020 08:02	13,93	1	13,93	CHI
20201228353	GOIANESIA	GE12006564	GOIANESIA S2	06/12/2020 18:05	07/12/2020 08:02	06/12/2020 18:05	07/12/2020 08:02	13,93	9	125,40	CHI
20201228574	MOIPORA	MO12073400	IPORA	06/12/2020 18:05	07/12/2020 00:58	06/12/2020 18:05	07/12/2020 00:58	6,87	30	206,08	CHI
20201228574	ISRAELANDIA	MO12073400	IPORA	06/12/2020 18:05	07/12/2020 00:58	06/12/2020 18:05	07/12/2020 00:58	6,87	15	103,04	CHI
20201228165	CAVALCANTE	740002624	FLORES DE GOIAS	06/12/2020 18:06	07/12/2020 12:20	06/12/2020 18:06	07/12/2020 12:20	18,23	1	18,23	CHI
20201228168	JATAI	10016675698	JATAI S2	06/12/2020 18:06	07/12/2020 09:26	06/12/2020 18:06	07/12/2020 09:26	15,33	1	15,33	CHI
20201228170	AGUA LIMPA	AL21292958	VILA CORUMBA	06/12/2020 18:06	06/12/2020 20:01	06/12/2020 18:06	06/12/2020 20:01	1,90	1	1,90	CHI

20201228177	CACU	CC21196136	CACHOEIRA ALTA	06/12/2020 18:07	06/12/2020 19:18	06/12/2020 18:07	06/12/2020 19:18	1,17	1	1,17	CHI
20201228760	MARA ROSA	MQ12380741	SANTA TEREZINHA	06/12/2020 18:09	07/12/2020 10:19	06/12/2020 18:09	07/12/2020 10:19	16,16	12	193,96	CHI
20201228249	DIORAMA	DI12065691	IPORA	06/12/2020 18:10	07/12/2020 10:18	06/12/2020 18:10	07/12/2020 10:18	16,13	8	129,05	CHI
20201228206	RIO VERDE	630206960	CABRIUVA S1	06/12/2020 18:11	07/12/2020 12:49	06/12/2020 18:11	07/12/2020 12:49	18,63	1	18,63	CHI
20201228210	CRISTALINA	KR21219729	CRISTALINA S2	06/12/2020 18:11	07/12/2020 13:20	06/12/2020 18:11	07/12/2020 13:20	19,14	1	19,14	CHI
20201228211	NOVA CRIXAS	NA11055777	NOVA CRIXAS	06/12/2020 18:11	06/12/2020 19:28	06/12/2020 18:11	06/12/2020 19:28	1,27	110	139,88	CHI
20201228213	PIRACANJUBA	PJ21111807	PIRACANJUBA	06/12/2020 18:12	07/12/2020 18:32	06/12/2020 18:12	07/12/2020 18:32	24,33	1	24,33	CHI
20201228221	GOIANIA	GN12001783	GOYA S1	06/12/2020 18:12	06/12/2020 20:22	06/12/2020 18:12	06/12/2020 20:22	2,17	224	486,64	CHI
20201228223	SAO LUIS DE MONTES BELOS	SL21316270	FIRMINOPOLIS S2	06/12/2020 18:12	06/12/2020 20:31	06/12/2020 18:12	06/12/2020 20:31	2,31	1	2,31	CHI
20201228226	BONOPOLIS	PO12374529	SAO MIGUEL DO ARAGUAIA	06/12/2020 18:12	07/12/2020 14:05	06/12/2020 18:12	07/12/2020 14:05	19,87	3	59,60	CHI
20201228510	CAMPO LIMPO	AN12414610	ANAPOLIS UNIVERSITARIO S2	06/12/2020 18:12	06/12/2020 20:35	06/12/2020 18:12	06/12/2020 20:35	2,38	2	4,76	CHI
20201228510	ANAPOLIS	AN12414610	ANAPOLIS UNIVERSITARIO S2	06/12/2020 18:12	06/12/2020 20:35	06/12/2020 18:12	06/12/2020 20:35	2,38	4	9,52	CHI
20201228228	GOUVELANDIA	GB12261016	QUIRINOPOLIS	06/12/2020 18:13	06/12/2020 18:49	06/12/2020 18:13	06/12/2020 18:49	0,60	5	2,98	CHI
20201228232	CRISTALINA	KR12389569	PAMPLONA	06/12/2020 18:13	07/12/2020 09:19	06/12/2020 18:13	07/12/2020 09:19	15,09	4	60,38	CHI
20201228235	GOIANIA	GN11001553	GOIANIA LESTE S1	06/12/2020 18:14	06/12/2020 20:14	06/12/2020 18:14	06/12/2020 20:14	2,00	142	284,04	CHI
20201228364	ITUMBIARA	IT11000158	ITUMBIARA NOVA	06/12/2020 18:14	07/12/2020 01:56	06/12/2020 18:14	07/12/2020 01:56	7,68	162	1244,84	CHI
20201228243	PIRACANJUBA	60017326	PIRACANJUBA	06/12/2020 18:15	07/12/2020 04:46	06/12/2020 18:15	07/12/2020 04:46	10,51	1	10,51	CHI
20201228248	MOIPORA	CO12300416	SAO LUIZ DOS MONTES BELOS	06/12/2020 18:16	07/12/2020 08:03	06/12/2020 18:16	07/12/2020 08:03	13,78	1	13,78	CHI
20201228251	GOIAS	GS21063246	GOIAS	06/12/2020 18:16	07/12/2020 09:29	06/12/2020 18:16	07/12/2020 09:29	15,20	1	15,20	CHI
20201228252	NOVA CRIXAS	NA12321651	NOVA CRIXAS	06/12/2020 18:17	07/12/2020 13:51	06/12/2020 18:17	07/12/2020 13:51	19,56	1	19,56	CHI
20201228261	VALPARAISO DE GOIAS	10016694773	MARAJOARA	06/12/2020 18:18	06/12/2020 21:44	06/12/2020 18:18	06/12/2020 21:44	3,42	1	3,42	CHI
20201227540	TRINDADE	TR11237589	TRINDADE	06/12/2020 18:19	06/12/2020 21:01	06/12/2020 18:19	06/12/2020 21:01	2,68	110	295,29	CHI
20201228262	NOVA AMERICA	NM21109078	RUBIATABA	06/12/2020 18:19	06/12/2020 21:56	06/12/2020 18:19	06/12/2020 21:56	3,61	1	3,61	CHI
20201228987	JARAGUA	JA12247683	JARAGUA	06/12/2020 18:19	06/12/2020 20:51	06/12/2020 18:19	06/12/2020 20:51	2,52	126	317,52	CHI
20201228275	ITAJA	IJ21249677	ITAJA S2	06/12/2020 18:22	06/12/2020 19:03	06/12/2020 18:22	06/12/2020 19:03	0,68	1	0,68	CHI
20201228277	RIO VERDE	RV21289527	SANTA HELENA S1	06/12/2020 18:22	06/12/2020 21:30	06/12/2020 18:22	06/12/2020 21:30	3,13	2	6,25	CHI
20201228280	RIO VERDE	RV21022574	MONTIVIDIU T	06/12/2020 18:23	07/12/2020 04:32	06/12/2020 18:23	07/12/2020 04:32	10,15	1	10,15	CHI
20201228281	GOIANESIA	GE12080429	GOIANESIA S1	06/12/2020 18:23	06/12/2020 21:31	06/12/2020 18:23	06/12/2020 21:31	3,13	12	37,58	CHI
20201228283	SANTA CRUZ DE GOIAS	BC21137544	PIRACANJUBA	06/12/2020 18:23	07/12/2020 21:01	06/12/2020 18:23	07/12/2020 21:01	26,63	1	26,63	CHI
20201228287	TAQUARAL DE GOIAS	II21217072	ITABERAI S1	06/12/2020 18:23	07/12/2020 11:30	06/12/2020 18:23	07/12/2020 11:30	17,11	1	17,11	CHI
20201228294	NOVA CRIXAS	NA12091693	NOVA CRIXAS	06/12/2020 18:23	07/12/2020 13:23	06/12/2020 18:23	07/12/2020 13:23	18,99	2	37,98	CHI
20201228298	LUZIANIA	LZ21087169	CRISTALINA S2	06/12/2020 18:25	06/12/2020 23:36	06/12/2020 18:25	06/12/2020 23:36	5,18	3	15,54	CHI
20201228300	MONTIVIDIU	MV21260065	MONTIVIDIU T	06/12/2020 18:25	06/12/2020 21:21	06/12/2020 18:25	06/12/2020 21:21	2,93	1	2,93	CHI
20201228301	CALDAS NOVAS	760240190	SERRA DE CALDAS	06/12/2020 18:25	06/12/2020 22:45	06/12/2020 18:25	06/12/2020 22:45	4,34	1	4,34	CHI
20201228390	MONTES CLAROS DE GOIAS	ME10343348	IPORA	06/12/2020 18:26	07/12/2020 14:47	06/12/2020 18:26	06/12/2020 23:17	4,86	78	378,73	CHI
20201228390	MONTES CLAROS DE GOIAS	ME10343348	IPORA	06/12/2020 18:26	07/12/2020 14:47	06/12/2020 18:26	07/12/2020 05:55	11,49	15	172,32	CHI
20201228390	MONTES CLAROS DE GOIAS	ME10343348	IPORA	06/12/2020 18:26	07/12/2020 14:47	06/12/2020 18:26	07/12/2020 08:50	14,40	39	561,65	CHI
20201228390	MONTES CLAROS DE GOIAS	ME10343348	IPORA	06/12/2020 18:26	07/12/2020 14:47	06/12/2020 18:26	07/12/2020 10:05	15,64	83	1298,51	CHI
20201228390	MONTES CLAROS DE GOIAS	ME10343348	IPORA	06/12/2020 18:26	07/12/2020 14:47	07/12/2020 10:08	07/12/2020 10:23	0,25	132	33,44	CHI
20201228390	MONTES CLAROS DE GOIAS	ME13074995	IPORA	06/12/2020 18:26	07/12/2020 14:47	07/12/2020 10:08	07/12/2020 14:23	4,26	83	353,21	CHI
20201228390	MONTES CLAROS DE GOIAS	ME10343348	IPORA	06/12/2020 18:26	07/12/2020 14:47	06/12/2020 18:26	07/12/2020 14:47	20,34	85	1729,28	CHI
20201228390	ARENOPOLIS	ME10343348	IPORA	06/12/2020 18:26	07/12/2020 14:47	06/12/2020 18:26	07/12/2020 14:47	20,34	136	2766,84	CHI
20201228390	BOM JARDIM DE GOIAS	ME10343348	IPORA	06/12/2020 18:26	07/12/2020 14:47	06/12/2020 18:26	07/12/2020 14:47	20,34	20	406,89	CHI
20201228390	PIRANHAS	ME10343348	IPORA	06/12/2020 18:26	07/12/2020 14:47	06/12/2020 18:26	07/12/2020 14:47	20,34	2	40,69	CHI
20201228390	MONTES CLAROS DE GOIAS	ME10343348	IPORA	06/12/2020 18:26	07/12/2020 14:47	06/12/2020 18:26	07/12/2020 14:47	20,34	629	12796,66	CHI
20201228390	ARAGARCAS	ME10343348	IPORA	06/12/2020 18:26	07/12/2020 14:47	06/12/2020 18:26	07/12/2020 14:47	20,34	51	1037,57	CHI
20201228390	ARENOPOLIS	ME10343348	IPORA	06/12/2020 18:26	07/12/2020 14:47	06/12/2020 18:26	07/12/2020 14:47	20,34	108	2197,20	CHI
20201228800	SANTA TEREZINHA DE GOIAS	SG12350024	SANTA TEREZINHA	06/12/2020 18:26	07/12/2020 07:54	06/12/2020 18:26	07/12/2020 07:54	13,46	16	215,42	CHI
20201228308	CACU	CC21322279	CACHOEIRA ALTA	06/12/2020 18:27	06/12/2020 20:50	06/12/2020 18:27	06/12/2020 20:50	2,40	1	2,40	CHI
20201228310	ITAJA	IJ2370148	ITAJA S2	06/12/2020 18:27	06/12/2020 20:25	06/12/2020 18:27	06/12/2020 20:25	1,96	2	3,93	CHI
20201228311	URUACU	CR11201694	CAMPINORTE	06/12/2020 18:27	06/12/2020 20:47	06/12/2020 18:27	06/12/2020 20:47	2,33	6	13,97	CHI

20201228315	CRISTALINA	KR21304923	CRISTALINA S2	06/12/2020 18:27	06/12/2020 22:44	06/12/2020 18:27	06/12/2020 22:44	4,27	1	4,27	CHI
20201228319	PIRENOPOLIS	PV12381257	CORUMBA	06/12/2020 18:28	07/12/2020 10:19	06/12/2020 18:28	07/12/2020 10:19	15,84	117	1853,41	CHI
20201228323	PADRE BERNARDO	PB12104239	PADRE BERNARDO	06/12/2020 18:28	06/12/2020 22:53	06/12/2020 18:28	06/12/2020 22:53	4,40	19	83,64	CHI
20201228482	JATAI	JT12131457	JATAI S1	06/12/2020 18:30	07/12/2020 09:25	06/12/2020 18:30	07/12/2020 09:25	14,90	13	193,71	CHI
20201228348	NIQUELANDIA	2750056890	NIQUELANDIA SUBTRANSMISSAO	06/12/2020 18:32	06/12/2020 19:48	06/12/2020 18:32	06/12/2020 19:48	1,25	1	1,25	CHI
20201228698	MINEIROS	MY11036556	PARQUE DAS EMAS	06/12/2020 18:32	06/12/2020 21:33	06/12/2020 18:32	06/12/2020 21:33	3,00	217	651,24	CHI
20201228363	GOIANIA	13188665	MEIA PONTE	06/12/2020 18:34	06/12/2020 22:11	06/12/2020 18:34	06/12/2020 22:11	3,61	1	3,61	CHI
20201228436	MONTES CLAROS DE GOIAS	ME12204903	IPORA	06/12/2020 18:34	07/12/2020 15:31	06/12/2020 18:34	07/12/2020 15:31	20,95	3	62,84	CHI
20201228477	SAO JOAO D ALIANCA	JL12016102	SAO JOAO D ALIANCA	06/12/2020 18:35	06/12/2020 21:01	06/12/2020 18:35	06/12/2020 21:01	2,43	352	854,68	CHI
20201228376	JATAI	290151971	JATAI S2	06/12/2020 18:37	07/12/2020 11:04	06/12/2020 18:37	07/12/2020 11:04	16,44	1	16,44	CHI
20201228386	COCALZINHO DE GOIAS	ZN21191484	COCALZINHO	06/12/2020 18:38	07/12/2020 11:27	06/12/2020 18:38	07/12/2020 11:27	16,81	1	16,81	CHI
20201228387	ANAPOLIS	10019344145	ANAPOLIS UNIVERSITARIO S2	06/12/2020 18:38	06/12/2020 22:01	06/12/2020 18:38	06/12/2020 22:01	3,38	1	3,38	CHI
20201228388	GOIANIA	GN21001920	AEROPORTO S3	06/12/2020 18:39	06/12/2020 22:41	06/12/2020 18:39	06/12/2020 22:41	4,03	18	72,54	CHI
20201228391	BELA VISTA DE GOIAS	10017534923	BELA VISTA S1	06/12/2020 18:39	06/12/2020 19:59	06/12/2020 18:39	06/12/2020 19:59	1,34	1	1,34	CHI
20201228395	GOIANESIA	10019954504	GOIANESIA S2	06/12/2020 18:39	07/12/2020 12:04	06/12/2020 18:39	07/12/2020 12:04	17,40	1	17,40	CHI
20201228398	TAQUARAL DE GOIAS	TQ121299564	ITABERAI S1	06/12/2020 18:40	07/12/2020 09:48	06/12/2020 18:40	07/12/2020 09:48	15,13	1	15,13	CHI
20201228399	COLINAS DO SUL	TI12355519	MINACU	06/12/2020 18:40	07/12/2020 08:23	06/12/2020 18:40	07/12/2020 08:23	13,71	5	68,56	CHI
20201228400	PIRENOPOLIS	PV21294272	CORUMBA	06/12/2020 18:40	06/12/2020 23:53	06/12/2020 18:40	06/12/2020 23:53	5,21	2	10,42	CHI
20201228401	CAMPO LIMPO	AN21258132	NEROPOLIS S1	06/12/2020 18:40	06/12/2020 21:39	06/12/2020 18:40	06/12/2020 21:39	2,98	2	5,96	CHI
20201228414	TEREZOPOLIS DE GOIAS	GP12353324	DAIA S2	06/12/2020 18:41	06/12/2020 22:18	06/12/2020 18:41	06/12/2020 22:18	3,61	9	32,48	CHI
20201228414	GOIANAPOLIS	GP12353324	DAIA S2	06/12/2020 18:41	06/12/2020 22:18	06/12/2020 18:41	06/12/2020 22:18	3,61	1	3,61	CHI
20201228433	QUIRINOPOLIS	QI12296563	QUIRINOPOLIS	06/12/2020 18:47	06/12/2020 20:04	06/12/2020 18:47	06/12/2020 20:04	1,28	5	6,41	CHI
20201228434	JATAI	JT21104000	JATAI S3	06/12/2020 18:47	07/12/2020 11:39	06/12/2020 18:47	07/12/2020 11:39	16,87	1	16,87	CHI
20201228437	RUBIATABA	RB12312152	RUBIATABA	06/12/2020 18:47	07/12/2020 08:00	06/12/2020 18:47	07/12/2020 08:00	13,22	4	52,89	CHI
20201228797	MONTES CLAROS DE GOIAS	ME12184441	IPORA	06/12/2020 18:47	07/12/2020 15:04	06/12/2020 18:47	07/12/2020 15:04	20,27	70	1418,92	CHI
20201228797	DIORAMA	ME12184441	IPORA	06/12/2020 18:47	07/12/2020 15:04	06/12/2020 18:47	07/12/2020 15:04	20,27	11	222,97	CHI
20201228448	GOIANESIA	GE12241509	GOIANESIA S1	06/12/2020 18:48	06/12/2020 22:51	06/12/2020 18:48	06/12/2020 22:51	4,04	2	8,08	CHI
20201228448	NOVA GLORIA	GE12241509	GOIANESIA S1	06/12/2020 18:48	06/12/2020 22:51	06/12/2020 18:48	06/12/2020 22:51	4,04	2	8,08	CHI
20201228448	SANTA ISABEL	GE12241509	GOIANESIA S1	06/12/2020 18:48	06/12/2020 22:51	06/12/2020 18:48	06/12/2020 22:51	4,04	2	8,08	CHI
20201228452	MINEIROS	MY12312323RE	PARQUE DAS EMAS	06/12/2020 18:49	07/12/2020 08:50	06/12/2020 18:49	07/12/2020 08:50	14,01	7	98,09	CHI
20201228462	NOVO GAMA	NJ1246134	ACAEMBU S2	06/12/2020 18:50	07/12/2020 00:46	06/12/2020 18:50	07/12/2020 00:46	5,93	2	11,85	CHI
20201228718	ARUANA	AK11183261	ARUANA	06/12/2020 18:50	06/12/2020 22:51	06/12/2020 18:50	06/12/2020 22:51	4,01	104	417,07	CHI
20201229112	FIRMINOPOLIS	FR12034137	SAO LUIZ DOS MONTES BELOS	06/12/2020 18:51	07/12/2020 13:27	06/12/2020 18:51	07/12/2020 13:27	18,59	36	669,37	CHI
20201228478	GOIANIA	10324501	CAMPINAS S1	06/12/2020 18:53	06/12/2020 19:43	06/12/2020 18:53	06/12/2020 19:43	0,83	1	0,83	CHI
20201228479	CABECEIRAS	CW21129740	ITUIQUIRA	06/12/2020 18:53	06/12/2020 19:43	06/12/2020 18:53	06/12/2020 19:43	0,83	1	0,83	CHI
20201228484	ARAGARCAS	AG11207761	ARAGARCAS	06/12/2020 18:53	06/12/2020 21:11	06/12/2020 18:53	06/12/2020 21:11	2,29	109	249,25	CHI
20201228491	MARA ROSA	MQ21293515	SANTA TEREZINHA	06/12/2020 18:54	07/12/2020 11:36	06/12/2020 18:54	07/12/2020 11:36	16,69	1	16,69	CHI
20201228553	TRINDADE	TR11000022	TRINDADE	06/12/2020 18:54	07/12/2020 02:30	06/12/2020 18:54	07/12/2020 02:30	7,60	103	782,37	CHI
20201228497	GOIATUBA	GT12035489LD	GOIATUBA S2	06/12/2020 18:55	07/12/2020 12:49	06/12/2020 18:55	07/12/2020 12:49	17,89	15	268,39	CHI
20201228499	VIANOPOLIS	VN21079975	VIANOPOLIS	06/12/2020 18:56	06/12/2020 20:17	06/12/2020 18:56	06/12/2020 20:17	1,35	1	1,35	CHI
20201228503	APARECIDA DE GOIANIA	AP11237564	ANHANGUERA	06/12/2020 18:56	06/12/2020 21:54	06/12/2020 18:56	06/12/2020 21:54	2,96	296	876,08	CHI
20201228505	NOVA GLORIA	NG12181400	ITAPACI	06/12/2020 18:56	06/12/2020 21:09	06/12/2020 18:56	06/12/2020 21:09	2,21	13	28,78	CHI
20201228515	GOIANIA	10096498	CAMPINAS S3	06/12/2020 18:58	06/12/2020 19:37	06/12/2020 18:58	06/12/2020 19:37	0,65	1	0,65	CHI
20201228519	APARECIDA DE GOIANIA	15343844	REAL S1	06/12/2020 18:58	06/12/2020 20:48	06/12/2020 18:58	06/12/2020 20:48	1,83	1	1,83	CHI
20201228524	FAINA	FC21188723	GOIAS	06/12/2020 18:59	07/12/2020 16:22	06/12/2020 18:59	07/12/2020 16:22	21,38	1	21,38	CHI
20201228525	PADRE BERNARDO	PB12243249	PADRE BERNARDO	06/12/2020 18:59	06/12/2020 19:53	06/12/2020 18:59	06/12/2020 19:53	0,90	1	0,90	CHI
20201228529	TURVELANDIA	TD12305980	RIO DOS BOIS	06/12/2020 18:59	06/12/2020 20:25	06/12/2020 18:59	06/12/2020 20:25	1,42	1	1,42	CHI
20201228536	BRITANIA	7338217	BRITANIA	06/12/2020 19:00	07/12/2020 04:13	06/12/2020 19:00	07/12/2020 04:13	9,21	1	9,21	CHI
20201228544	AGUA FRIA DE GOIAS	TL21302713	SAO JOAO D ALIANCA	06/12/2020 19:01	07/12/2020 08:37	06/12/2020 19:01	07/12/2020 08:37	13,59	1	13,59	CHI
20201228547	EDEALINA	ED12246149	PONTALINA	06/12/2020 19:01	07/12/2020 09:21	06/12/2020 19:01	07/12/2020 09:21	14,32	1	14,32	CHI
20201228612	TRINDADE	TR11383861	GOYA S2	06/12/2020 19:01	07/12/2020 03:45	06/12/2020 19:01	07/12/2020 03:45	8,72	92	802,32	CHI

20201228549	FORMOSA	FA21428501	SAO JOAO D ALIANCA	06/12/2020 19:02	06/12/2020 19:30	06/12/2020 19:02	06/12/2020 19:30	0,46	1	0,46	CHI
20201228555	GOIAS	GS21188221	GOIAS	06/12/2020 19:02	07/12/2020 07:38	06/12/2020 19:02	07/12/2020 07:38	12,58	1	12,58	CHI
20201228695	RIO VERDE	RV12260701	CABRIUVA S1	06/12/2020 19:02	07/12/2020 09:49	06/12/2020 19:02	07/12/2020 09:49	14,77	2	29,54	CHI
20201228560	GOUVELANDIA	GB12000207	QUIRINOPOLIS	06/12/2020 19:03	07/12/2020 00:29	06/12/2020 19:03	07/12/2020 00:29	5,42	4	21,68	CHI
20201228581	GOIANDIRA	2010001753	CATALAO S1	06/12/2020 19:05	06/12/2020 20:12	06/12/2020 19:05	06/12/2020 20:12	1,11	1	1,11	CHI
20201228585	IPORA	IR12060656	ARENOPOLIS	06/12/2020 19:05	07/12/2020 10:21	06/12/2020 19:05	07/12/2020 10:21	15,25	6	91,51	CHI
20201228681	FLORES DE GOIAS	FB11092768	FLORES DE GOIAS	06/12/2020 19:05	07/12/2020 01:46	06/12/2020 19:05	07/12/2020 01:46	6,68	225	1503,00	CHI
20201228589	GOIANIA	14324090	ATLANTICO S1	06/12/2020 19:06	06/12/2020 20:35	06/12/2020 19:06	06/12/2020 20:35	1,48	1	1,48	CHI
20201228590	JATAI	JT12241744	JATAI S3	06/12/2020 19:06	07/12/2020 13:29	06/12/2020 19:06	07/12/2020 13:29	18,38	3	55,14	CHI
20201228706	CAMPO LIMPO	AN12261235	NEROPOLIS S1	06/12/2020 19:06	06/12/2020 20:27	06/12/2020 19:06	06/12/2020 20:27	1,35	3	4,04	CHI
20201228598	DAVINOPOLIS	IO12000011RE	CATALAO S1	06/12/2020 19:08	06/12/2020 20:13	06/12/2020 19:08	06/12/2020 20:13	1,08	34	36,68	CHI
20201228598	TRES RANCHOS	IO12000011RE	CATALAO S1	06/12/2020 19:08	06/12/2020 20:13	06/12/2020 19:08	06/12/2020 20:13	1,08	4	4,32	CHI
20201228598	OUVIDOR	IO12000011RE	CATALAO S1	06/12/2020 19:08	06/12/2020 20:13	06/12/2020 19:08	06/12/2020 20:13	1,08	11	11,87	CHI
20201228598	DISTRITO FEDERAL	IO12000011RE	CATALAO S1	06/12/2020 19:08	06/12/2020 20:13	06/12/2020 19:08	06/12/2020 20:13	1,08	3	3,24	CHI
20201228601	ALOANDIA	650007347	GOIATUBA S1	06/12/2020 19:08	06/12/2020 22:15	06/12/2020 19:08	06/12/2020 22:15	3,12	1	3,12	CHI
20201233165	SAO LUIS DE MONTES BELOS	SL12003914	SAO LUIZ DOS MONTES BELOS	06/12/2020 19:08	07/12/2020 16:14	06/12/2020 19:08	07/12/2020 16:14	21,09	13	274,20	CHI
20201228836	GUARINOS	GF12164877	SANTA TEREZINHA	06/12/2020 19:09	07/12/2020 08:11	06/12/2020 19:09	07/12/2020 08:11	13,03	14	182,35	CHI
20201229539	IPAMERI	IP12275809	IPAMERI	06/12/2020 19:09	06/12/2020 23:17	06/12/2020 19:09	06/12/2020 23:17	4,12	152	626,20	CHI
20201228615	PIRENOPOLIS	10015730539	CORUMBA	06/12/2020 19:11	07/12/2020 04:12	06/12/2020 19:11	07/12/2020 04:12	9,01	1	9,01	CHI
20201228641	AGUAS LINDAS DE GOIAS	4830034313	AGUAS LINDAS DE GOIAS S1	06/12/2020 19:13	06/12/2020 20:19	06/12/2020 19:13	06/12/2020 20:19	1,09	1	1,09	CHI
20201228645	URUACU	UR21000029	CAMPINORTE	06/12/2020 19:14	06/12/2020 20:11	06/12/2020 19:14	06/12/2020 20:11	0,94	1	0,94	CHI
20201229048	CAMPOS VERDES	VD11037451	SANTA TEREZINHA	06/12/2020 19:14	07/12/2020 00:48	06/12/2020 19:14	07/12/2020 00:48	5,55	65	361,04	CHI
20201228649	NOVA GLORIA	NG21328123	RUBIATABA	06/12/2020 19:15	07/12/2020 13:49	06/12/2020 19:15	07/12/2020 13:49	18,56	1	18,56	CHI
20201228652	SAO MIGUEL DO ARAGUAIA	SM21328099	SAO MIGUEL DO ARAGUAIA	06/12/2020 19:16	07/12/2020 15:45	06/12/2020 19:16	07/12/2020 15:45	20,47	1	20,47	CHI
20201228654	SANTO ANTONIO DO DESCOBERTO	NJ21219695	MARAJOARA	06/12/2020 19:16	06/12/2020 23:09	06/12/2020 19:16	06/12/2020 23:09	3,87	1	3,87	CHI
20201228655	MORRINHOS	MR21101298	MORRINHOS	06/12/2020 19:17	06/12/2020 22:14	06/12/2020 19:17	06/12/2020 22:14	2,95	1	2,95	CHI
20201228669	ACREUNA	2440022294	ACREUNA	06/12/2020 19:18	07/12/2020 07:55	06/12/2020 19:18	07/12/2020 07:55	12,60	1	12,60	CHI
20201228673	LEOPOLDO DE BULHOES	LB21072591	DAIA S2	06/12/2020 19:20	06/12/2020 21:53	06/12/2020 19:20	06/12/2020 21:53	2,55	1	2,55	CHI
20201228675	GOIANIA	12305388	GOYA S2	06/12/2020 19:20	06/12/2020 20:27	06/12/2020 19:20	06/12/2020 20:27	1,10	1	1,10	CHI
202012179379	QUIRINOPOLIS	GB12394808	QUIRINOPOLIS	06/12/2020 19:21	07/12/2020 01:51	06/12/2020 19:21	07/12/2020 01:51	6,50	78	506,96	CHI
202012179379	GOUVELANDIA	GB12394808	QUIRINOPOLIS	06/12/2020 19:21	07/12/2020 01:51	06/12/2020 19:21	07/12/2020 01:51	6,50	2	13,00	CHI
20201229782	FLORES DE GOIAS	FB11315830	FLORES DE GOIAS	06/12/2020 19:23	08/12/2020 07:36	06/12/2020 19:23	08/12/2020 07:36	36,20	37	1339,46	CHI
20201228692	GOIANAPOLIS	10030035714	DAIA S2	06/12/2020 19:24	06/12/2020 22:26	06/12/2020 19:24	06/12/2020 22:26	3,03	1	3,03	CHI
20201228701	PALMEIRAS DE GOIAS	PL12033918	PALMEIRAS	06/12/2020 19:26	06/12/2020 21:56	06/12/2020 19:26	06/12/2020 21:56	2,50	23	57,44	CHI
20201228703	FORMOSA	FA11254236	ITIQUEIRA	06/12/2020 19:26	07/12/2020 11:35	06/12/2020 19:26	07/12/2020 11:35	16,14	1	16,14	CHI
20201228707	MINEIROS	MY21137217	PARQUE DAS EMAS	06/12/2020 19:26	07/12/2020 18:13	06/12/2020 19:26	07/12/2020 18:13	22,77	1	22,77	CHI
20201228708	NOVO GAMA	2460014175	PACAEMBU S1	06/12/2020 19:26	06/12/2020 21:46	06/12/2020 19:26	06/12/2020 21:46	2,32	1	2,32	CHI
20201228709	NIQUELANDIA	NQ21243617	NIQUELANDIA SUBTRANSMISSAO	06/12/2020 19:27	07/12/2020 09:30	06/12/2020 19:27	07/12/2020 09:30	14,05	2	28,09	CHI
20201228710	GOIANIA	GN12271986	CAMPINAS S2	06/12/2020 19:27	06/12/2020 21:01	06/12/2020 19:27	06/12/2020 21:01	1,58	3	4,73	CHI
20201228762	CACHOEIRA DOURADA	CD12000007RE	CACHOEIRA DOURADA	06/12/2020 19:27	07/12/2020 17:15	06/12/2020 19:27	07/12/2020 17:15	21,79	27	588,30	CHI
20201228762	ITUMBIARA	CD12000007RE	CACHOEIRA DOURADA	06/12/2020 19:27	07/12/2020 17:15	06/12/2020 19:27	07/12/2020 17:15	21,79	27	588,30	CHI
20201228717	RIO VERDE	RV12261024	CACHOEIRA ALTA	06/12/2020 19:28	07/12/2020 10:22	06/12/2020 19:28	07/12/2020 10:22	14,88	3	44,65	CHI
20201228726	NIQUELANDIA	NQ12274742	BARRO ALTO	06/12/2020 19:30	06/12/2020 22:25	06/12/2020 19:30	06/12/2020 22:25	2,91	17	49,49	CHI
20201228729	ITARUMA	IM21303141	CACHOEIRA ALTA	06/12/2020 19:30	06/12/2020 22:20	06/12/2020 19:30	06/12/2020 22:20	2,84	2	5,68	CHI
20201228731	VILA PROPICIO	PV12397326	GOIANESIA S1	06/12/2020 19:31	07/12/2020 19:48	06/12/2020 19:31	07/12/2020 19:48	24,28	4	97,13	CHI
20201228734	CALDAS NOVAS	CN21000065	CALDAS NOVAS S2	06/12/2020 19:31	07/12/2020 00:13	06/12/2020 19:31	07/12/2020 00:13	4,69	1	4,69	CHI
20201228813	RUBIATABA	RB11273187	RUBIATABA	06/12/2020 19:32	07/12/2020 14:27	06/12/2020 19:32	07/12/2020 13:46	18,23	35	638,05	CHI
20201228813	RUBIATABA	RB12273121	RUBIATABA	06/12/2020 19:32	07/12/2020 14:27	07/12/2020 13:30	07/12/2020 14:27	0,95	116	110,52	CHI
20201228744	ANAPOLIS	20572712	JUNDIAI S1	06/12/2020 19:33	06/12/2020 21:04	06/12/2020 19:33	06/12/2020 21:04	1,53	1	1,53	CHI
20201228745	IACIARA	IA12211664	IACIARA S2	06/12/2020 19:33	07/12/2020 11:00	06/12/2020 19:33	07/12/2020 11:00	15,45	9	139,02	CHI
20201228747	COCALZINHO DE GOIAS	ZN12394288	COCALZINHO	06/12/2020 19:33	07/12/2020 14:29	06/12/2020 19:33	07/12/2020 14:29	18,92	2	37,84	CHI

20201228747	CORUMBA DE GOIAS	ZN12394288	COCALZINHO	06/12/2020 19:33	07/12/2020 14:29	06/12/2020 19:33	07/12/2020 14:29	18,92	11	208,09	CHI
20201228750	PALMEIRAS DE GOIAS	10018257478	PALMEIRAS	06/12/2020 19:34	06/12/2020 23:48	06/12/2020 19:34	06/12/2020 23:48	4,23	1	4,23	CHI
20201228751	TRINDADE	TR11000032	TRINDADE	06/12/2020 19:34	07/12/2020 02:34	06/12/2020 19:34	07/12/2020 02:34	6,99	143	999,77	CHI
20201228752	SAO JOAO D ALIANCA	JL12238306	ITUIQUIRA	06/12/2020 19:35	07/12/2020 13:16	06/12/2020 19:35	07/12/2020 13:16	17,69	13	229,96	CHI
20201228763	SANTA CRUZ DE GOIAS	BC21304008	PIRES DO RIO S2	06/12/2020 19:36	07/12/2020 00:51	06/12/2020 19:36	07/12/2020 00:13	4,61	1	4,61	CHI
20201228763	SANTA CRUZ DE GOIAS	BC21304008	PIRES DO RIO S2	06/12/2020 19:36	07/12/2020 00:51	07/12/2020 00:45	07/12/2020 00:51	0,10	1	0,10	CHI
20201228992	CACU	CC12164172LD	CACHOEIRA ALTA	06/12/2020 19:36	06/12/2020 23:02	06/12/2020 19:36	06/12/2020 23:02	3,42	85	290,61	CHI
20201228769	ITUMBIARA	690385523	ITUMBIARA VELHA S1	06/12/2020 19:37	07/12/2020 21:24	06/12/2020 19:37	07/12/2020 21:24	25,78	1	25,78	CHI
20201228770	CACU	CC21019873	CACHOEIRA ALTA	06/12/2020 19:37	06/12/2020 22:26	06/12/2020 19:37	06/12/2020 22:26	2,81	1	2,81	CHI
20201228773	AGUAS LINDAS DE GOIAS	10020673742	AGUAS LINDAS DE GOIAS S2	06/12/2020 19:37	06/12/2020 21:48	06/12/2020 19:37	06/12/2020 21:48	2,17	1	2,17	CHI
20201228775	CACHOEIRA DOURADA	IT12081121	CACHOEIRA DOURADA	06/12/2020 19:38	07/12/2020 20:17	06/12/2020 19:38	07/12/2020 20:17	24,63	1	24,63	CHI
20201228784	COLINAS DO SUL	TI11116080	MINACU	06/12/2020 19:41	07/12/2020 02:00	06/12/2020 19:41	07/12/2020 02:00	6,32	69	435,79	CHI
20201228788	MINACU	IH21230301	MINACU	06/12/2020 19:41	08/12/2020 00:14	06/12/2020 19:41	08/12/2020 00:14	28,54	1	28,54	CHI
20201228789	SANTO ANTONIO DO DESCOBERTO	SN11131982	MARAJOARA	06/12/2020 19:41	06/12/2020 23:31	06/12/2020 19:41	06/12/2020 23:31	3,83	53	202,99	CHI
20201229299	PALMEIRAS DE GOIAS	IY12158920LD	EDEIA	06/12/2020 19:41	07/12/2020 14:35	06/12/2020 19:41	07/12/2020 14:35	18,89	5	94,47	CHI
20201229299	INDIARA	IY12158920LD	EDEIA	06/12/2020 19:41	07/12/2020 14:35	06/12/2020 19:41	07/12/2020 14:35	18,89	27	510,12	CHI
20201228790	CRISTALINA	KR12389576	CRISTALINA S2	06/12/2020 19:42	07/12/2020 01:04	06/12/2020 19:42	07/12/2020 01:04	5,37	39	209,29	CHI
20201228801	TAQUARAL DE GOIAS	IX12016021	INHUMAS S1	06/12/2020 19:44	06/12/2020 21:33	06/12/2020 19:44	06/12/2020 21:33	1,81	48	86,83	CHI
20201228801	ITAUCU	IX12016021	INHUMAS S1	06/12/2020 19:44	06/12/2020 21:33	06/12/2020 19:44	06/12/2020 21:33	1,81	49	88,64	CHI
20201228808	VILA PROPICIO	NP11228400	GOIANESIA S1	06/12/2020 19:45	06/12/2020 22:33	06/12/2020 19:45	06/12/2020 22:33	2,80	1	2,80	CHI
20201228812	GOIANAPOLIS	950015921	DAIA S2	06/12/2020 19:45	06/12/2020 21:46	06/12/2020 19:45	06/12/2020 21:46	2,01	1	2,01	CHI
20201229359	QUIRINOPOLIS	QI32007538	QUIRINOPOLIS	06/12/2020 19:47	07/12/2020 09:56	06/12/2020 19:47	07/12/2020 09:56	14,14	43	607,88	CHI
20201228828	LUZIANIA	10024398436	RIO VERMELHO	06/12/2020 19:48	07/12/2020 07:32	06/12/2020 19:48	07/12/2020 07:32	11,73	1	11,73	CHI
20201228839	MARA ROSA	MQ10403947	MARA ROSA	06/12/2020 19:48	07/12/2020 12:58	06/12/2020 19:48	06/12/2020 21:51	2,05	4	8,19	CHI
20201228839	NOVA IGUACU DE GOIAS	MQ10400799	MARA ROSA	06/12/2020 19:48	07/12/2020 12:58	06/12/2020 19:48	06/12/2020 21:52	2,07	24	49,68	CHI
20201228839	MARA ROSA	MQ10400799	MARA ROSA	06/12/2020 19:48	07/12/2020 12:58	06/12/2020 19:48	06/12/2020 21:52	2,07	150	310,50	CHI
20201228839	ALTO HORIZONTE	MQ10400799	MARA ROSA	06/12/2020 19:48	07/12/2020 12:58	06/12/2020 19:48	06/12/2020 21:52	2,07	85	175,95	CHI
20201228839	URUACU	MQ10400799	MARA ROSA	06/12/2020 19:48	07/12/2020 12:58	06/12/2020 19:48	06/12/2020 21:52	2,07	1	2,07	CHI
20201228839	MARA ROSA	MQ10403947	MARA ROSA	06/12/2020 19:48	07/12/2020 12:58	06/12/2020 19:48	06/12/2020 22:51	3,06	25	76,54	CHI
20201228839	MARA ROSA	MQ10403947	MARA ROSA	06/12/2020 19:48	07/12/2020 12:58	06/12/2020 19:48	07/12/2020 11:11	15,39	9	138,48	CHI
20201228839	MARA ROSA	MQ12072578	MARA ROSA	06/12/2020 19:48	07/12/2020 12:58	06/12/2020 19:48	07/12/2020 12:00	16,21	6	97,28	CHI
20201228839	MARA ROSA	MQ12146955	MARA ROSA	06/12/2020 19:48	07/12/2020 12:58	06/12/2020 19:48	07/12/2020 12:58	17,18	12	206,13	CHI
20201228831	CAMPINORTE	CR21164019	MARA ROSA	06/12/2020 19:49	07/12/2020 02:36	06/12/2020 19:49	07/12/2020 02:36	6,78	1	6,78	CHI
20201228841	FLORES DE GOIAS	3480006617	FLORES DE GOIAS	06/12/2020 19:50	08/12/2020 18:07	06/12/2020 19:50	08/12/2020 18:07	46,28	1	46,28	CHI
20201228843	IPAMERI	IP12266897	IPAMERI	06/12/2020 19:50	07/12/2020 09:49	06/12/2020 19:50	07/12/2020 09:49	13,98	5	69,89	CHI
20201228888	VILA BOA	FB10407015	IACIARA S2	06/12/2020 19:50	07/12/2020 15:27	06/12/2020 19:50	06/12/2020 19:54	0,07	63	4,34	CHI
20201228888	FLORES DE GOIAS	FB10407015	IACIARA S2	06/12/2020 19:50	07/12/2020 15:27	06/12/2020 19:50	06/12/2020 19:54	0,07	271	18,67	CHI
20201228888	FLORES DE GOIAS	FB10407015	IACIARA S2	06/12/2020 19:50	07/12/2020 15:27	06/12/2020 19:50	06/12/2020 21:48	1,96	428	840,43	CHI
20201228888	SITIO D ABADIA	FB10407015	IACIARA S2	06/12/2020 19:50	07/12/2020 15:27	06/12/2020 19:50	06/12/2020 21:48	1,96	117	229,74	CHI
20201228888	FLORES DE GOIAS	FB10410987	IACIARA S2	06/12/2020 19:50	07/12/2020 15:27	06/12/2020 19:50	07/12/2020 02:07	6,28	376	2362,01	CHI
20201228888	FLORES DE GOIAS	FB13344338	IACIARA S2	06/12/2020 19:50	07/12/2020 15:27	06/12/2020 19:50	07/12/2020 15:27	19,61	149	2921,81	CHI
20201228888	FLORES DE GOIAS	FB10410987	IACIARA S2	06/12/2020 19:50	07/12/2020 15:27	06/12/2020 19:50	07/12/2020 15:27	19,61	3	58,83	CHI
20201228852	BALIZA	BH12331395	CAIAPONIA	06/12/2020 19:51	07/12/2020 19:18	06/12/2020 19:51	07/12/2020 13:29	17,64	29	511,70	CHI
20201228852	BALIZA	BH12331395	CAIAPONIA	06/12/2020 19:51	07/12/2020 19:18	06/12/2020 19:51	07/12/2020 19:18	23,45	38	891,27	CHI
20201228852	BALIZA	BH13331493	CAIAPONIA	06/12/2020 19:51	07/12/2020 19:18	07/12/2020 09:12	07/12/2020 19:18	10,11	1	10,11	CHI
20201228853	SAO LUIS DE MONTES BELOS	SL12006943	SAO LUIZ DOS MONTES BELOS	06/12/2020 19:51	06/12/2020 23:00	06/12/2020 19:51	06/12/2020 23:00	3,14	4	12,58	CHI
20201228855	FORMOSA	FA12309132	ITUIQUIRA	06/12/2020 19:52	07/12/2020 14:28	06/12/2020 19:52	07/12/2020 14:28	18,60	2	37,20	CHI
20201228866	CAVALCANTE	CJ21286409	MINACU	06/12/2020 19:53	06/12/2020 20:59	06/12/2020 19:53	06/12/2020 20:59	1,10	1	1,10	CHI
20201228871	LUZIANIA	KR21120575	CRISTALINA S2	06/12/2020 19:53	07/12/2020 02:02	06/12/2020 19:53	07/12/2020 02:02	6,14	1	6,14	CHI
20201229541	IPAMERI	IP12071026	IPAMERI	06/12/2020 19:53	07/12/2020 14:36	06/12/2020 19:53	07/12/2020 14:36	18,70	7	130,92	CHI
20201228914	CIDADE OCIDENTAL	10015064369	MARAJOARA	06/12/2020 19:58	07/12/2020 07:58	06/12/2020 19:58	07/12/2020 07:58	11,99	1	11,99	CHI

20201228919	SENADOR CANEDO	190026170	SENADOR CANEDO	06/12/2020 19:59	06/12/2020 21:15	06/12/2020 19:59	06/12/2020 21:15	1,27	1	1,27	CHI
20201228948	INDIARA	IY12391436	EDEIA	06/12/2020 19:59	07/12/2020 16:27	06/12/2020 19:59	07/12/2020 16:27	20,46	10	204,59	CHI
20201228953	JATAI	JT21286462	CABRIUVA S2	06/12/2020 19:59	06/12/2020 20:28	06/12/2020 19:59	06/12/2020 20:28	0,47	1	0,47	CHI
20201229347	QUIRINOPOLIS	QI18271537TS	QUIRINOPOLIS	06/12/2020 19:59	07/12/2020 02:04	06/12/2020 19:59	07/12/2020 02:04	6,08	93	565,28	CHI
20201228959	APARECIDA DE GOIANIA	200047530	INDEPENDENCIA S1	06/12/2020 20:00	06/12/2020 21:16	06/12/2020 20:00	06/12/2020 21:16	1,26	1	1,26	CHI
20201228965	ABADIANIA	AA12348133	ANAPOLIS UNIVERSITARIO S1	06/12/2020 20:01	07/12/2020 00:17	06/12/2020 20:01	07/12/2020 00:17	4,27	16	68,25	CHI
20201228967	QUIRINOPOLIS	QI21301487	QUIRINOPOLIS	06/12/2020 20:01	07/12/2020 09:58	06/12/2020 20:01	07/12/2020 09:58	13,95	4	55,79	CHI
20201229142	JATAI	JT12092395	JATAI S1	06/12/2020 20:02	07/12/2020 05:09	06/12/2020 20:02	07/12/2020 05:09	9,11	76	691,98	CHI
20201228979	GOUVELANDIA	2250009059	QUIRINOPOLIS	06/12/2020 20:03	07/12/2020 07:35	06/12/2020 20:03	07/12/2020 07:35	11,52	1	11,52	CHI
20201228985	PADRE BERNARDO	PB12389380	PADRE BERNARDO	06/12/2020 20:04	06/12/2020 21:36	06/12/2020 20:04	06/12/2020 21:36	1,52	13	19,74	CHI
20201228991	EDEIA	1120011489	EDEIA	06/12/2020 20:06	06/12/2020 22:01	06/12/2020 20:06	06/12/2020 22:01	1,91	1	1,91	CHI
20201228993	IACIARA	IA12257653	IACIARA S1	06/12/2020 20:07	07/12/2020 13:19	06/12/2020 20:07	07/12/2020 10:48	14,68	4	58,73	CHI
20201228993	IACIARA	IA12257653	IACIARA S1	06/12/2020 20:07	07/12/2020 13:19	06/12/2020 20:07	07/12/2020 12:04	15,95	1	15,95	CHI
20201228993	IACIARA	IA12257653	IACIARA S1	06/12/2020 20:07	07/12/2020 13:19	06/12/2020 20:07	07/12/2020 13:19	17,21	1	17,21	CHI
20201228997	QUIRINOPOLIS	QI12000241	QUIRINOPOLIS	06/12/2020 20:07	06/12/2020 23:21	06/12/2020 20:07	06/12/2020 23:21	3,22	9	28,95	CHI
20201229009	CRIXAS	CX12399926	RUBIATABA	06/12/2020 20:10	07/12/2020 12:09	06/12/2020 20:10	07/12/2020 12:09	15,98	18	287,60	CHI
20201230189	APARECIDA DO RIO DOCE	JT12081473	JATAI S1	06/12/2020 20:10	07/12/2020 13:36	06/12/2020 20:10	07/12/2020 13:36	17,42	10	174,22	CHI
20201229016	PORTEIROAO	CL21301084	RIO DOS BOIS	06/12/2020 20:11	06/12/2020 21:13	06/12/2020 20:11	06/12/2020 21:13	1,03	1	1,03	CHI
20201229017	PLANALTINA	PI12103612	PLANALTINA	06/12/2020 20:11	06/12/2020 22:31	06/12/2020 20:11	06/12/2020 22:31	2,33	20	46,54	CHI
20201229153	ORIZONA	OZ12114502	PIRES DO RIO S2	06/12/2020 20:12	06/12/2020 23:04	06/12/2020 20:12	06/12/2020 23:04	2,86	15	42,85	CHI
20201229033	GOIANIA	10005542977	ATLANTICO S1	06/12/2020 20:13	06/12/2020 22:23	06/12/2020 20:13	06/12/2020 22:23	2,16	1	2,16	CHI
20201229340	INDIARA	IY12010846	EDEIA	06/12/2020 20:13	07/12/2020 13:41	06/12/2020 20:13	07/12/2020 13:41	17,45	16	279,20	CHI
20201229043	GUARANI DE GOIAS	GY12344199	IACIARA S1	06/12/2020 20:15	06/12/2020 23:42	06/12/2020 20:15	06/12/2020 23:42	3,44	5	17,20	CHI
20201229044	CRISTALINA	KR21290677	CRISTALINA S1	06/12/2020 20:15	07/12/2020 14:07	06/12/2020 20:15	07/12/2020 14:07	17,85	1	17,85	CHI
20201229057	GUAPO	GA11000008	GUAPO S2	06/12/2020 20:20	06/12/2020 23:11	06/12/2020 20:20	06/12/2020 23:11	2,84	90	255,92	CHI
20201229059	LUZIANIA	LZ21033415	RIO VERMELHO	06/12/2020 20:20	07/12/2020 00:38	06/12/2020 20:20	07/12/2020 00:38	4,29	1	4,29	CHI
20201229133	ITARUMA	IJ12107422LD	ITAJA S2	06/12/2020 20:20	06/12/2020 22:00	06/12/2020 20:20	06/12/2020 22:00	1,65	24	39,64	CHI
20201229094	CACHOEIRA DOURADA	130001831	CACHOEIRA DOURADA	06/12/2020 20:25	07/12/2020 13:42	06/12/2020 20:25	07/12/2020 13:42	17,27	1	17,27	CHI
20201229101	GOIANIA	10715575	CAMPINAS S3	06/12/2020 20:27	06/12/2020 22:09	06/12/2020 20:27	06/12/2020 22:09	1,70	1	1,70	CHI
20201229102	ARUANA	AK21187700	MOZARLANDIA	06/12/2020 20:27	07/12/2020 08:19	06/12/2020 20:27	07/12/2020 08:19	11,86	1	11,86	CHI
20201229105	CAMPO ALEGRE DE GOIAS	CM12192739	CAMPO ALEGRE DE GOIAS	06/12/2020 20:27	07/12/2020 07:18	06/12/2020 20:27	07/12/2020 07:18	10,84	3	32,51	CHI
20201229111	VALPARAISO DE GOIAS	10005407280	MARAJOARA	06/12/2020 20:28	06/12/2020 22:02	06/12/2020 20:28	06/12/2020 22:02	1,56	1	1,56	CHI
20201230361	FORMOSA	FA12204623	SAO JOAO D ALIANCA	06/12/2020 20:28	07/12/2020 11:36	06/12/2020 20:28	07/12/2020 11:36	15,12	19	287,25	CHI
20201229116	CATALAO	CT21192703	CATALAO S2	06/12/2020 20:29	07/12/2020 00:10	06/12/2020 20:29	07/12/2020 00:10	3,68	1	3,68	CHI
20201229123	PORTELANDIA	PW12303462RE	PARQUE DAS EMAS	06/12/2020 20:29	08/12/2020 17:27	06/12/2020 20:29	08/12/2020 17:27	44,95	8	359,60	CHI
20201229123	PORTELANDIA	PW12303462RE	PARQUE DAS EMAS	06/12/2020 20:29	08/12/2020 17:27	07/12/2020 23:24	08/12/2020 17:27	18,04	2	36,09	CHI
20201229416	TRINDADE	TR12087490	TRINDADE	06/12/2020 20:30	06/12/2020 23:31	06/12/2020 20:30	06/12/2020 23:31	3,02	439	1323,95	CHI
20201229138	QUIRINOPOLIS	QI21013484	QUIRINOPOLIS	06/12/2020 20:32	07/12/2020 12:04	06/12/2020 20:32	07/12/2020 12:04	15,53	1	15,53	CHI
20201229141	BOM JESUS DE GOIAS	BJ12263544	BOM JESUS DE GOIAS	06/12/2020 20:32	07/12/2020 17:03	06/12/2020 20:32	07/12/2020 17:03	20,50	6	123,03	CHI
202012179348	MARA ROSA	MQ12390465	MARA ROSA	06/12/2020 20:32	07/12/2020 13:41	06/12/2020 20:32	06/12/2020 21:38	1,11	82	90,79	CHI
202012179348	AMARALINA	MQ12390465	MARA ROSA	06/12/2020 20:32	07/12/2020 13:41	06/12/2020 20:32	06/12/2020 21:38	1,11	3	3,32	CHI
202012179348	AMARALINA	MQ12390465	MARA ROSA	06/12/2020 20:32	07/12/2020 13:41	06/12/2020 20:32	07/12/2020 13:41	17,15	286	4903,71	CHI
202012179348	MARA ROSA	MQ12390465	MARA ROSA	06/12/2020 20:32	07/12/2020 13:41	06/12/2020 20:32	07/12/2020 13:41	17,15	11	188,60	CHI
20201229151	CACHOEIRA DOURADA	CD12000008RE	CACHOEIRA DOURADA	06/12/2020 20:34	07/12/2020 12:47	06/12/2020 20:34	07/12/2020 12:47	16,21	18	291,73	CHI
20201229151	ITUMBIARA	CD12000008RE	CACHOEIRA DOURADA	06/12/2020 20:34	07/12/2020 12:47	06/12/2020 20:34	07/12/2020 12:47	16,21	20	324,15	CHI
20201229173	CATALAO	CT12231641	CATALAO S1	06/12/2020 20:35	06/12/2020 22:02	06/12/2020 20:35	06/12/2020 22:02	1,44	10	14,40	CHI
20201229173	GOIANDIRA	CT12231641	CATALAO S1	06/12/2020 20:35	06/12/2020 22:02	06/12/2020 20:35	06/12/2020 22:02	1,44	3	4,32	CHI
20201229438	CACHOEIRA ALTA	CA12419934	CACHOEIRA ALTA	06/12/2020 20:36	07/12/2020 10:15	06/12/2020 23:42	07/12/2020 09:25	9,72	34	330,38	CHI
20201229438	CACHOEIRA ALTA	CA12419934	CACHOEIRA ALTA	06/12/2020 20:36	07/12/2020 10:15	07/12/2020 09:11	07/12/2020 09:25	0,23	10	2,31	CHI
20201229438	CACHOEIRA ALTA	CA12075249LD	CACHOEIRA ALTA	06/12/2020 20:36	07/12/2020 10:15	06/12/2020 20:36	07/12/2020 10:15	13,65	32	436,93	CHI
20201229438	PARANAIGUARA	CA12075249LD	CACHOEIRA ALTA	06/12/2020 20:36	07/12/2020 10:15	06/12/2020 20:36	07/12/2020 10:15	13,65	34	464,24	CHI

20201230429	CASTELANDIA	QI12050368	QUIRINOPOLIS	06/12/2020 20:36	07/12/2020 08:09	06/12/2020 20:36	07/12/2020 08:09	11,54	1	11,54	CHI
20201230429	QUIRINOPOLIS	QI12050368	QUIRINOPOLIS	06/12/2020 20:36	07/12/2020 08:09	06/12/2020 20:36	07/12/2020 08:09	11,54	82	946,60	CHI
20201229167	GOIANIA	11632860	GOIANIA LESTE S1	06/12/2020 20:37	06/12/2020 22:17	06/12/2020 20:37	06/12/2020 22:17	1,66	1	1,66	CHI
20201229220	ITAUCU	IX12000030	INHUMAS S1	06/12/2020 20:38	06/12/2020 22:05	06/12/2020 20:38	06/12/2020 22:05	1,45	4	5,80	CHI
20201229220	INHUMAS	IX12000030	INHUMAS S1	06/12/2020 20:38	06/12/2020 22:05	06/12/2020 20:38	06/12/2020 22:05	1,45	12	17,39	CHI
20201229181	TERESINA DE GOIAS	TE21218389	FLORES DE GOIAS	06/12/2020 20:40	07/12/2020 09:37	06/12/2020 20:40	07/12/2020 09:37	12,94	1	12,94	CHI
20201229188	NIQUELANDIA	NQ21213028	URUACU	06/12/2020 20:41	06/12/2020 23:04	06/12/2020 20:41	06/12/2020 23:04	2,37	1	2,37	CHI
20201230492	MUNDO NOVO DE GOIAS	MH12269056	NOVA CRIXAS	06/12/2020 20:41	07/12/2020 08:47	06/12/2020 20:41	07/12/2020 08:47	12,09	22	265,89	CHI
20201229197	PALMEIRAS DE GOIAS	PL21060860	PALMEIRAS	06/12/2020 20:43	07/12/2020 01:00	06/12/2020 20:43	07/12/2020 01:00	4,27	1	4,27	CHI
20201229199	RIO VERDE	10009907376	RIO VERDE S2	06/12/2020 20:43	07/12/2020 07:55	06/12/2020 20:43	07/12/2020 07:55	11,18	1	11,18	CHI
20201229218	CACU	00270434	CACHOEIRA ALTA	06/12/2020 20:43	07/12/2020 20:04	06/12/2020 20:43	06/12/2020 23:57	3,23	3	9,69	CHI
20201229218	CACHOEIRA ALTA	00270434	CACHOEIRA ALTA	06/12/2020 20:43	07/12/2020 20:04	06/12/2020 20:43	06/12/2020 23:57	3,23	8	25,84	CHI
20201229218	CACHOEIRA ALTA	00270434	CACHOEIRA ALTA	06/12/2020 20:43	07/12/2020 20:04	07/12/2020 02:40	07/12/2020 06:24	3,75	8	29,97	CHI
20201229218	CACU	00270434	CACHOEIRA ALTA	06/12/2020 20:43	07/12/2020 20:04	07/12/2020 02:40	07/12/2020 06:24	3,75	3	11,24	CHI
20201229218	ITARUMA	00270434	CACHOEIRA ALTA	06/12/2020 20:43	07/12/2020 20:04	06/12/2020 20:43	07/12/2020 11:57	15,23	45	685,25	CHI
20201229218	ITARUMA	00270434	CACHOEIRA ALTA	06/12/2020 20:43	07/12/2020 20:04	06/12/2020 20:43	07/12/2020 11:57	15,23	6	91,37	CHI
20201229218	ITARUMA	00270434	CACHOEIRA ALTA	06/12/2020 20:43	07/12/2020 20:04	06/12/2020 20:43	07/12/2020 11:57	15,23	81	1233,45	CHI
20201229218	LAGOA SANTA	00270434	CACHOEIRA ALTA	06/12/2020 20:43	07/12/2020 20:04	06/12/2020 20:43	07/12/2020 11:57	15,23	17	258,87	CHI
20201229218	CACU	00270434	CACHOEIRA ALTA	06/12/2020 20:43	07/12/2020 20:04	06/12/2020 20:43	07/12/2020 11:57	15,23	55	837,53	CHI
20201229218	ITAJA	00270434	CACHOEIRA ALTA	06/12/2020 20:43	07/12/2020 20:04	06/12/2020 20:43	07/12/2020 11:57	15,23	41	624,34	CHI
20201229218	ITAJA	00270434	CACHOEIRA ALTA	06/12/2020 20:43	07/12/2020 20:04	06/12/2020 20:43	07/12/2020 11:57	15,23	7	106,59	CHI
20201229218	LAGOA SANTA	00270434	CACHOEIRA ALTA	06/12/2020 20:43	07/12/2020 20:04	06/12/2020 20:43	07/12/2020 12:48	16,09	3	48,26	CHI
20201229218	ITARUMA	00270434	CACHOEIRA ALTA	06/12/2020 20:43	07/12/2020 20:04	06/12/2020 20:43	07/12/2020 12:48	16,09	130	2091,34	CHI
20201229218	CACU	00270434	CACHOEIRA ALTA	06/12/2020 20:43	07/12/2020 20:04	06/12/2020 20:43	07/12/2020 12:48	16,09	4	64,35	CHI
20201229218	ITAJA	00270434	CACHOEIRA ALTA	06/12/2020 20:43	07/12/2020 20:04	06/12/2020 20:43	07/12/2020 12:48	16,09	3	48,26	CHI
20201229218	ITAJA	00270434	CACHOEIRA ALTA	06/12/2020 20:43	07/12/2020 20:04	06/12/2020 20:43	07/12/2020 12:48	16,09	15	241,31	CHI
20201229218	ITAJA	00270434	CACHOEIRA ALTA	06/12/2020 20:43	07/12/2020 20:04	06/12/2020 20:43	07/12/2020 12:48	16,09	31	498,70	CHI
20201229218	ITARUMA	03700214	CACHOEIRA ALTA	06/12/2020 20:43	07/12/2020 20:04	07/12/2020 12:01	07/12/2020 13:41	1,67	45	75,36	CHI
20201229218	ITARUMA	03700214	CACHOEIRA ALTA	06/12/2020 20:43	07/12/2020 20:04	07/12/2020 13:49	07/12/2020 16:04	2,25	3	6,74	CHI
20201229218	ITARUMA	7610624	CACHOEIRA ALTA	06/12/2020 20:43	07/12/2020 20:04	07/12/2020 13:49	07/12/2020 20:04	6,26	20	125,12	CHI
20201229218	ITARUMA	03700214	CACHOEIRA ALTA	06/12/2020 20:43	07/12/2020 20:04	07/12/2020 13:49	07/12/2020 20:04	6,26	22	137,63	CHI
20201229205	GOIAS	GS11082079	GOIAS	06/12/2020 20:45	07/12/2020 09:05	06/12/2020 20:45	07/12/2020 09:05	12,33	2	24,66	CHI
20201229575	ACREUNA	EU12260946	ACREUNA	06/12/2020 20:46	07/12/2020 14:14	06/12/2020 20:46	07/12/2020 14:14	17,47	24	419,22	CHI
20201229226	SAO DOMINGOS	GY21332270	SAO DOMINGOS	06/12/2020 20:48	06/12/2020 21:28	06/12/2020 20:48	06/12/2020 21:28	0,66	1	0,66	CHI
20201229295	VARJAO	GA12082436	GUAPO S2	06/12/2020 20:48	06/12/2020 22:44	06/12/2020 20:48	06/12/2020 22:44	1,92	25	48,08	CHI
20201229295	GUAPO	GA12082436	GUAPO S2	06/12/2020 20:48	06/12/2020 22:44	06/12/2020 20:48	06/12/2020 22:44	1,92	45	86,55	CHI
20201229233	INDIARA	IY31057280	EDEIA	06/12/2020 20:49	07/12/2020 09:00	06/12/2020 20:49	07/12/2020 09:00	12,17	1	12,17	CHI
20201229238	ANAPOLIS	10019345397	JUNDIAI S1	06/12/2020 20:51	06/12/2020 23:18	06/12/2020 20:51	06/12/2020 23:18	2,45	1	2,45	CHI
20201229249	MOZARLANDIA	MZ21352407	MOZARLANDIA	06/12/2020 20:54	06/12/2020 23:18	06/12/2020 20:54	06/12/2020 23:18	2,39	1	2,39	CHI
20201229252	NOVO PLANALTO	TA21277314	NOVO PLANALTO	06/12/2020 20:54	07/12/2020 18:05	06/12/2020 20:54	07/12/2020 18:05	21,17	1	21,17	CHI
20201229256	PORANGATU	TB12208457	PORANGATU	06/12/2020 20:56	06/12/2020 22:35	06/12/2020 20:56	06/12/2020 22:35	1,64	1	1,64	CHI
20201229256	TROMBAS	TB12208457	PORANGATU	06/12/2020 20:56	06/12/2020 22:35	06/12/2020 20:56	06/12/2020 22:35	1,64	15	24,61	CHI
20201229258	MUNDO NOVO DE GOIAS	MH12391949	NOVA CRIXAS	06/12/2020 20:56	07/12/2020 07:36	06/12/2020 20:56	07/12/2020 07:36	10,65	43	458,06	CHI
20201229301	SANTA RITA DO NOVO DESTINO	BA12152774	BARRO ALTO	06/12/2020 20:58	06/12/2020 23:28	06/12/2020 20:58	06/12/2020 23:28	2,50	71	177,24	CHI
20201229276	GOIANIA	10004504060	REAL S1	06/12/2020 21:00	06/12/2020 22:37	06/12/2020 21:00	06/12/2020 22:37	1,61	1	1,61	CHI
20201229474	CEZARINA	CZ12259266	CEZARINA	06/12/2020 21:00	07/12/2020 15:44	06/12/2020 21:00	07/12/2020 15:44	18,73	5	93,63	CHI
20201229283	SIMOLANDIA	SA12221147	IACIARA S2	06/12/2020 21:01	07/12/2020 12:52	06/12/2020 21:01	07/12/2020 12:52	15,85	12	190,19	CHI
20201230321	FORMOSA	FA12261997	ITUIQUIRA	06/12/2020 21:01	07/12/2020 10:12	06/12/2020 21:01	07/12/2020 10:12	13,18	30	395,27	CHI
20201229298	CABECEIRAS	CW21085531	ITUIQUIRA	06/12/2020 21:04	06/12/2020 23:20	06/12/2020 21:04	06/12/2020 23:20	2,26	1	2,26	CHI
20201229304	BRITANIA	BT12131110	BRITANIA	06/12/2020 21:05	08/12/2020 13:39	06/12/2020 21:05	07/12/2020 15:56	18,85	21	395,87	CHI
20201229304	BRITANIA	BT13117805	BRITANIA	06/12/2020 21:05	08/12/2020 13:39	06/12/2020 21:05	08/12/2020 13:39	40,56	9	365,03	CHI

20201229428	SAO LUIZ DO NORTE	SZ12243712	ITAPACI	06/12/2020 21:07	07/12/2020 09:12	06/12/2020 21:07	07/12/2020 09:12	12,07	13	156,93	CHI
20201229428	ITAPACI	SZ12243712	ITAPACI	06/12/2020 21:07	07/12/2020 09:12	06/12/2020 21:07	07/12/2020 09:12	12,07	3	36,21	CHI
20201229499	GUAPO	GA12276656	GUAPO S2	06/12/2020 21:08	07/12/2020 08:16	06/12/2020 21:08	07/12/2020 08:16	11,12	6	66,71	CHI
20201229718	SAO LUIS DE MONTES BELOS	SL32145768	SAO LUIZ DOS MONTES BELOS	06/12/2020 21:09	07/12/2020 01:12	06/12/2020 21:09	07/12/2020 01:12	4,05	29	117,43	CHI
20201229333	APARECIDA DE GOIANIA	200638105	ANHANGUERA	06/12/2020 21:11	06/12/2020 21:57	06/12/2020 21:11	06/12/2020 21:57	0,76	1	0,76	CHI
20201229493	CUMARI	CT12011274LD	CATALAO S2	06/12/2020 21:11	07/12/2020 05:18	06/12/2020 21:11	07/12/2020 05:18	8,12	13	105,55	CHI
20201229493	CATALAO	CT12011274LD	CATALAO S2	06/12/2020 21:11	07/12/2020 05:18	06/12/2020 21:11	07/12/2020 05:18	8,12	371	3012,11	CHI
20201229493	CUMARI	CT10400808	CATALAO S2	06/12/2020 21:11	07/12/2020 05:18	07/12/2020 02:58	07/12/2020 05:18	2,35	3	7,04	CHI
20201229493	CATALAO	CT10400808	CATALAO S2	06/12/2020 21:11	07/12/2020 05:18	07/12/2020 02:58	07/12/2020 05:18	2,35	30	70,35	CHI
20201229338	VIANOPOLIS	VN12052254	VIANOPOLIS	06/12/2020 21:13	06/12/2020 22:37	06/12/2020 21:13	06/12/2020 22:37	1,40	132	184,47	CHI
20201229356	ITABERAI	IB21406509	ITABERAI S1	06/12/2020 21:18	07/12/2020 09:09	06/12/2020 21:18	07/12/2020 09:09	11,84	1	11,84	CHI
20201229357	SERRANOPOLIS	SX21267482	JATAI S1	06/12/2020 21:18	07/12/2020 19:11	06/12/2020 21:18	07/12/2020 19:11	21,87	1	21,87	CHI
20201229385	MUNDO NOVO DE GOIAS	MH12357676	NOVA CRIXAS	06/12/2020 21:18	07/12/2020 03:48	06/12/2020 21:18	07/12/2020 03:48	6,49	24	155,73	CHI
20201229383	PIRENOPOLIS	PV21385387	CORUMBA	06/12/2020 21:23	07/12/2020 11:01	06/12/2020 21:23	07/12/2020 11:01	13,63	2	27,25	CHI
20201229731	GOIAS	GK12220543	ITAPURANGA	06/12/2020 21:23	07/12/2020 09:05	06/12/2020 21:23	07/12/2020 09:05	11,69	11	128,54	CHI
20201229731	GUARAITA	GK12220543	ITAPURANGA	06/12/2020 21:23	07/12/2020 09:05	06/12/2020 21:23	07/12/2020 09:05	11,69	22	257,08	CHI
20201229646	TRINDADE	TR12242149	TRINDADE	06/12/2020 21:24	07/12/2020 02:47	06/12/2020 21:24	07/12/2020 02:47	5,37	303	1626,27	CHI
20201229396	AGUAS LINDAS DE GOIAS	LA11199735	AGUAS LINDAS DE GOIAS S1	06/12/2020 21:26	07/12/2020 02:05	06/12/2020 21:26	07/12/2020 02:05	4,65	166	771,16	CHI
20201230100	ORIZONA	OZ12114504	PIRES DO RIO S2	06/12/2020 21:27	07/12/2020 17:10	06/12/2020 21:27	07/12/2020 17:10	19,71	10	197,13	CHI
20201229411	PILAR DE GOIAS	HL12237446	URUACU	06/12/2020 21:28	07/12/2020 04:08	06/12/2020 21:28	07/12/2020 04:08	6,65	2	13,31	CHI
20201230045	PLANALTINA	PI12218356	PLANALTINA	06/12/2020 21:32	07/12/2020 07:44	06/12/2020 21:32	07/12/2020 07:44	10,19	31	316,00	CHI
20201229420	VILA PROPICIO	NP12327893LD	GOIANESIA S1	06/12/2020 21:33	06/12/2020 23:21	06/12/2020 21:33	06/12/2020 23:21	1,79	97	173,95	CHI
20201229459	ITAPURANGA	IK12299882	ITAPURANGA	06/12/2020 21:35	07/12/2020 07:22	06/12/2020 21:35	07/12/2020 07:22	9,78	12	117,36	CHI
20201230554	CACU	CC12063061	CACHOEIRA ALTA	06/12/2020 21:35	07/12/2020 12:39	06/12/2020 21:35	07/12/2020 12:39	15,06	1	15,06	CHI
20201230554	ITARUMA	CC12063061	CACHOEIRA ALTA	06/12/2020 21:35	07/12/2020 12:39	06/12/2020 21:35	07/12/2020 12:39	15,06	4	60,23	CHI
20201229434	CAMPO ALEGRE DE GOIAS	IP21048128	PIRES DO RIO S2	06/12/2020 21:37	07/12/2020 10:41	06/12/2020 21:37	07/12/2020 10:41	13,06	1	13,06	CHI
20201229450	SAO MIGUEL DO ARAGUAIA	SM11276324	SAO MIGUEL DO ARAGUAIA	06/12/2020 21:41	07/12/2020 13:35	06/12/2020 21:41	07/12/2020 13:35	15,90	1	15,90	CHI
20201229453	ITAUCU	IX12018278	INHUMAS S1	06/12/2020 21:41	06/12/2020 22:51	06/12/2020 21:41	06/12/2020 22:51	1,16	75	86,79	CHI
20201229807	AMORINOPOLIS	AM12040176	IPORA	06/12/2020 21:42	07/12/2020 20:50	06/12/2020 21:42	07/12/2020 20:50	23,13	12	277,51	CHI
20201229807	IPORA	AM12040176	IPORA	06/12/2020 21:42	07/12/2020 20:50	06/12/2020 21:42	07/12/2020 20:50	23,13	6	138,76	CHI
20201229475	LUZIANIA	LZ12082360	PACAEMBU S2	06/12/2020 21:44	07/12/2020 00:18	06/12/2020 21:44	07/12/2020 00:18	2,55	3	7,65	CHI
20201229524	TRINDADE	TR11381821	TRINDADE	06/12/2020 21:44	07/12/2020 04:16	06/12/2020 21:44	07/12/2020 04:16	6,52	99	645,81	CHI
20201229488	JANDAIA	JD12255748	ACREUNA	06/12/2020 21:46	07/12/2020 07:27	06/12/2020 21:46	07/12/2020 07:27	9,67	1	9,67	CHI
20201229488	ACREUNA	JD12255748	ACREUNA	06/12/2020 21:46	07/12/2020 07:27	06/12/2020 21:46	07/12/2020 07:27	9,67	5	48,37	CHI
20201230480	MINEIROS	MY12045367RE	PARQUE DAS EMAS	06/12/2020 21:46	07/12/2020 13:42	06/12/2020 21:46	07/12/2020 13:00	15,23	26	395,98	CHI
20201230480	MINEIROS	MY12153058RE	PARQUE DAS EMAS	06/12/2020 21:46	07/12/2020 13:42	07/12/2020 13:01	07/12/2020 13:42	0,68	13	8,90	CHI
20201230480	SANTA RITA DO ARAGUAIA	MY12153058RE	PARQUE DAS EMAS	06/12/2020 21:46	07/12/2020 13:42	07/12/2020 13:01	07/12/2020 13:42	0,68	8	5,48	CHI
20201229490	TURVANIA	TV12058371	FIRMINOPOLIS S2	06/12/2020 21:47	07/12/2020 09:20	06/12/2020 21:47	07/12/2020 09:20	11,54	6	69,25	CHI
20201229501	ITUMBIARA	IT12113986	BOM JESUS DE GOIAS	06/12/2020 21:50	08/12/2020 05:09	06/12/2020 21:50	08/12/2020 05:09	31,31	1	31,31	CHI
20201229605	ORIZONA	OZ11140712	PIRES DO RIO S2	06/12/2020 21:50	06/12/2020 23:36	06/12/2020 21:50	06/12/2020 23:36	1,76	149	261,74	CHI
20201229512	GOIANIA	11618176	GOYA S1	06/12/2020 21:51	06/12/2020 22:42	06/12/2020 21:51	06/12/2020 22:42	0,84	1	0,84	CHI
20201229532	MINEIROS	MY12377570	PARQUE DAS EMAS	06/12/2020 21:54	07/12/2020 01:02	06/12/2020 21:54	07/12/2020 01:02	3,12	105	327,48	CHI
20201229613	PADRE BERNARDO	PB12305108	PADRE BERNARDO	06/12/2020 21:55	06/12/2020 23:35	06/12/2020 21:55	06/12/2020 23:35	1,66	4	6,64	CHI
20201229652	QUIRINOPOLIS	QI10401491	QUIRINOPOLIS	06/12/2020 21:55	07/12/2020 13:29	06/12/2020 22:12	07/12/2020 01:03	2,85	73	207,97	CHI
20201229652	RIO VERDE	QI10401491	QUIRINOPOLIS	06/12/2020 21:55	07/12/2020 13:29	06/12/2020 22:12	07/12/2020 02:01	3,83	116	444,05	CHI
20201229652	CACHOEIRA ALTA	QI10401491	QUIRINOPOLIS	06/12/2020 21:55	07/12/2020 13:29	06/12/2020 22:12	07/12/2020 02:01	3,83	39	149,29	CHI
20201229652	QUIRINOPOLIS	QI10401491	QUIRINOPOLIS	06/12/2020 21:55	07/12/2020 13:29	06/12/2020 22:12	07/12/2020 02:01	3,83	289	1106,31	CHI
20201229652	QUIRINOPOLIS	QI10401491	QUIRINOPOLIS	06/12/2020 21:55	07/12/2020 13:29	06/12/2020 22:12	07/12/2020 02:01	3,83	88	336,87	CHI
20201229652	RIO VERDE	QI10401491	QUIRINOPOLIS	06/12/2020 21:55	07/12/2020 13:29	06/12/2020 22:12	07/12/2020 02:01	3,83	41	156,95	CHI
20201229652	QUIRINOPOLIS	QI13000040	QUIRINOPOLIS	06/12/2020 21:55	07/12/2020 13:29	06/12/2020 22:12	07/12/2020 02:01	3,83	67	256,48	CHI
20201229652	CACHOEIRA ALTA	QI10401491	QUIRINOPOLIS	06/12/2020 21:55	07/12/2020 13:29	06/12/2020 22:12	07/12/2020 02:01	3,83	3	11,48	CHI

20201229652	CACHOEIRA ALTA	QI10401491	CACHOEIRA ALTA	06/12/2020 21:55	07/12/2020 13:29	06/12/2020 22:12	07/12/2020 10:29	12,28	7	85,97	CHI
20201229652	QUIRINOPOLIS	QI10401491	CACHOEIRA ALTA	06/12/2020 21:55	07/12/2020 13:29	06/12/2020 22:12	07/12/2020 10:29	12,28	23	282,48	CHI
20201229652	QUIRINOPOLIS	QI10401491	CACHOEIRA ALTA	06/12/2020 21:55	07/12/2020 13:29	06/12/2020 22:12	07/12/2020 12:35	14,39	12	172,65	CHI
20201229652	QUIRINOPOLIS	QI12065835LD	CACHOEIRA ALTA	06/12/2020 21:55	07/12/2020 13:29	06/12/2020 22:12	07/12/2020 13:29	15,28	11	168,13	CHI
20201229531	SILVANIA	SV21339252	VIANOPOLIS	06/12/2020 21:56	07/12/2020 01:11	06/12/2020 21:56	07/12/2020 01:11	3,25	2	6,50	CHI
20201229534	CACHOEIRA ALTA	10005061073	CACHOEIRA ALTA	06/12/2020 21:56	07/12/2020 12:30	06/12/2020 21:56	07/12/2020 12:30	14,56	1	14,56	CHI
20201229864	MINEIROS	MY11346617	PARQUE DAS EMAS	06/12/2020 21:56	07/12/2020 04:29	06/12/2020 21:56	07/12/2020 04:29	6,54	19	124,33	CHI
20201230910	MATRINCHA	MP12183061	MOZARLANDIA	06/12/2020 21:58	08/12/2020 00:49	06/12/2020 21:58	08/12/2020 00:49	26,84	28	751,45	CHI
20201230910	ARUANA	MP12183061	MOZARLANDIA	06/12/2020 21:58	08/12/2020 00:49	06/12/2020 21:58	08/12/2020 00:49	26,84	8	214,70	CHI
20201229588	PIRACANJUBA	JS10406682	ROCHEDO	06/12/2020 22:00	06/12/2020 23:48	06/12/2020 22:00	06/12/2020 23:48	1,79	287	514,69	CHI
20201229588	HIDROLANDIA	JS10406682	ROCHEDO	06/12/2020 22:00	06/12/2020 23:48	06/12/2020 22:00	06/12/2020 23:48	1,79	9	16,14	CHI
20201229588	CROMINIA	JS10406682	ROCHEDO	06/12/2020 22:00	06/12/2020 23:48	06/12/2020 22:00	06/12/2020 23:48	1,79	4	7,17	CHI
20201229588	PROFESSOR JAMIL SAFADY	JS10406682	ROCHEDO	06/12/2020 22:00	06/12/2020 23:48	06/12/2020 22:00	06/12/2020 23:48	1,79	169	303,07	CHI
20201229576	CRISTALINA	KR11060230	PAMPLONA	06/12/2020 22:01	07/12/2020 03:37	06/12/2020 22:01	07/12/2020 03:37	5,58	220	1228,52	CHI
20201229580	NIQUELANDIA	NQ21361956	URUACU	06/12/2020 22:03	06/12/2020 23:01	06/12/2020 22:03	06/12/2020 23:01	0,96	1	0,96	CHI
20201229962	PARANAIGUARA	PC12191538	CACHOEIRA ALTA	06/12/2020 22:05	07/12/2020 12:13	06/12/2020 22:05	07/12/2020 12:13	14,14	517	7310,81	CHI
20201229595	ITABERAI	IB21364838	ITABERAI S1	06/12/2020 22:07	07/12/2020 07:39	06/12/2020 22:07	07/12/2020 07:39	9,53	2	19,06	CHI
20201231091	BALIZA	BH12331413	CAIAPONIA	06/12/2020 22:07	07/12/2020 23:39	06/12/2020 22:07	07/12/2020 23:39	25,52	14	357,32	CHI
20201229602	URUACU	20119114	URUACU	06/12/2020 22:09	07/12/2020 12:00	06/12/2020 22:09	07/12/2020 12:00	13,85	1	13,85	CHI
20201229616	FORMOSA	FA12408135	ITUIQUIRA	06/12/2020 22:13	07/12/2020 01:46	06/12/2020 22:13	07/12/2020 01:46	3,54	237	839,11	CHI
20201230625	INDIARA	EA12352545	EDEIA	06/12/2020 22:15	07/12/2020 11:12	06/12/2020 22:15	07/12/2020 11:12	12,94	20	258,78	CHI
20201230625	EDEIA	EA12352545	EDEIA	06/12/2020 22:15	07/12/2020 11:12	06/12/2020 22:15	07/12/2020 11:12	12,94	3	38,82	CHI
20201229627	GOIANIA	SW12200298	GOIANIA LESTE S2	06/12/2020 22:16	07/12/2020 00:02	06/12/2020 22:16	07/12/2020 00:02	1,77	5	8,83	CHI
20201229632	COLINAS DO SUL	Ti21288522	MINACU	06/12/2020 22:16	07/12/2020 02:43	06/12/2020 22:16	07/12/2020 02:43	4,44	1	4,44	CHI
20201229634	ORIZONA	OZ21248900	PIRES DO RIO S2	06/12/2020 22:17	07/12/2020 00:21	06/12/2020 22:17	07/12/2020 00:21	2,06	1	2,06	CHI
20201229635	PARANAIGUARA	2230006806	CACHOEIRA ALTA	06/12/2020 22:17	07/12/2020 10:19	06/12/2020 22:17	07/12/2020 10:19	12,03	1	12,03	CHI
20201229732	LEOPOLDO DE BULHOES	LB12351258	DAIA S2	06/12/2020 22:17	07/12/2020 00:22	06/12/2020 22:17	07/12/2020 00:22	2,08	9	18,73	CHI
20201229638	ARAGARCAS	1820035818	ARAGARCAS	06/12/2020 22:18	07/12/2020 08:27	06/12/2020 22:18	07/12/2020 08:27	10,16	1	10,16	CHI
20201229640	GOIANIA	16507575	GOIANIA LESTE S3	06/12/2020 22:18	07/12/2020 00:32	06/12/2020 22:18	07/12/2020 00:32	2,22	1	2,22	CHI
20201229643	MINEIROS	MY11036556	PARQUE DAS EMAS	06/12/2020 22:19	07/12/2020 03:07	06/12/2020 22:19	07/12/2020 03:07	4,79	217	1040,27	CHI
20201229648	BURITINOPOLIS	BQ12228969	IACIARA S2	06/12/2020 22:19	07/12/2020 08:19	06/12/2020 22:19	07/12/2020 08:19	9,98	1	9,98	CHI
20201229654	GOIANIA	13960775	MEIA PONTE	06/12/2020 22:23	07/12/2020 00:08	06/12/2020 22:23	07/12/2020 00:08	1,75	1	1,75	CHI
20201229662	QUIRINOPOLIS	10010876195	QUIRINOPOLIS	06/12/2020 22:25	07/12/2020 10:20	06/12/2020 22:25	07/12/2020 10:20	11,91	1	11,91	CHI
20201229667	SERRANOPOLIS	SX21216742	JATAI S1	06/12/2020 22:26	07/12/2020 16:02	06/12/2020 22:26	07/12/2020 16:02	17,59	1	17,59	CHI
20201229675	CEZARINA	1650017975	CEZARINA	06/12/2020 22:32	07/12/2020 14:45	06/12/2020 22:32	07/12/2020 14:45	16,20	1	16,20	CHI
20201229680	POSSE	PS12124649	IACIARA S2	06/12/2020 22:34	07/12/2020 21:49	06/12/2020 22:34	07/12/2020 15:57	17,37	3	52,11	CHI
20201229680	POSSE	PS12124649	IACIARA S2	06/12/2020 22:34	07/12/2020 21:49	06/12/2020 22:34	07/12/2020 16:23	17,80	1	17,80	CHI
20201229680	POSSE	PS12124649	IACIARA S2	06/12/2020 22:34	07/12/2020 21:49	06/12/2020 22:34	07/12/2020 16:54	18,33	16	293,28	CHI
20201229680	POSSE	PS12124649	IACIARA S2	06/12/2020 22:34	07/12/2020 21:49	06/12/2020 22:34	07/12/2020 21:49	23,24	2	46,48	CHI
20201229685	NOVA CRIXAS	NA12357679	NOVA CRIXAS	06/12/2020 22:36	07/12/2020 03:07	06/12/2020 22:36	07/12/2020 03:07	4,51	8	36,06	CHI
20201231698	GOIANESIA	GE12258467	GOIANESIA S1	06/12/2020 22:39	07/12/2020 13:37	06/12/2020 22:39	07/12/2020 13:37	14,96	11	164,57	CHI
20201231698	SANTA RITA DO NOVO DESTINO	GE12258467	GOIANESIA S1	06/12/2020 22:39	07/12/2020 13:37	06/12/2020 22:39	07/12/2020 13:37	14,96	17	254,33	CHI
20201229693	SANTO ANTONIO DO DESCOBERTO	SN11168710	ALEXANIA	06/12/2020 22:41	07/12/2020 02:16	06/12/2020 22:41	07/12/2020 02:16	3,58	115	411,16	CHI
20201229695	ITAUCU	AR12104723	ARACU	06/12/2020 22:42	07/12/2020 00:36	06/12/2020 22:42	07/12/2020 00:36	1,89	9	17,03	CHI
20201229695	ARACU	AR12104723	ARACU	06/12/2020 22:42	07/12/2020 00:36	06/12/2020 22:42	07/12/2020 00:36	1,89	23	43,53	CHI
20201229888	PARAUNA	PU12079039	PARAUNA	06/12/2020 22:45	07/12/2020 13:47	06/12/2020 22:45	07/12/2020 09:18	10,55	2	21,10	CHI
20201229888	PARAUNA	PU12007905LD	PARAUNA	06/12/2020 22:45	07/12/2020 13:47	06/12/2020 22:45	07/12/2020 13:47	15,03	36	541,20	CHI
20201229714	CALDAS NOVAS	CN12226663	CALDAS NOVAS S1	06/12/2020 22:52	07/12/2020 00:54	06/12/2020 22:52	07/12/2020 00:54	2,03	6	12,18	CHI
20201229715	CACHOEIRA DOURADA	CD10407487	CACHOEIRA DOURADA	06/12/2020 22:52	07/12/2020 13:25	06/12/2020 22:52	07/12/2020 10:02	11,16	14	156,29	CHI
20201229715	CACHOEIRA DOURADA	CD10407487	CACHOEIRA DOURADA	06/12/2020 22:52	07/12/2020 13:25	06/12/2020 22:52	07/12/2020 12:40	13,81	28	386,66	CHI
20201229715	INACIOLANDIA	CD10407487	CACHOEIRA DOURADA	06/12/2020 22:52	07/12/2020 13:25	06/12/2020 22:52	07/12/2020 12:40	13,81	2	27,62	CHI

20201229715	INACIOLANDIA	CD10407487	CACHOEIRA DOURADA	06/12/2020 22:52	07/12/2020 13:25	06/12/2020 22:52	07/12/2020 13:25	14,55	83	1207,90	CHI
20201229715	CACHOEIRA DOURADA	CD10407487	CACHOEIRA DOURADA	06/12/2020 22:52	07/12/2020 13:25	06/12/2020 22:52	07/12/2020 13:25	14,55	1	14,55	CHI
20201229715	ITUMBIARA	CD10407487	CACHOEIRA DOURADA	06/12/2020 22:52	07/12/2020 13:25	06/12/2020 22:52	07/12/2020 13:25	14,55	13	189,19	CHI
20201229715	INACIOLANDIA	CD13000011	CACHOEIRA DOURADA	06/12/2020 22:52	07/12/2020 13:25	07/12/2020 00:13	07/12/2020 13:25	13,20	18	237,55	CHI
20201229720	NIQUELANDIA	NQ21264152	URUACU	06/12/2020 22:55	07/12/2020 02:56	06/12/2020 22:55	07/12/2020 02:56	4,00	2	8,01	CHI
20201229729	GOIANIA	14027707	CARAJAS S1	06/12/2020 22:56	07/12/2020 02:43	06/12/2020 22:56	07/12/2020 02:43	3,77	1	3,77	CHI
20201230511	ARAGUAPAZ	MS12113246	ITAPURANGA	06/12/2020 22:56	07/12/2020 09:09	06/12/2020 22:56	07/12/2020 09:09	10,21	2	20,42	CHI
20201230511	FAINA	MS12113246	ITAPURANGA	06/12/2020 22:56	07/12/2020 09:09	06/12/2020 22:56	07/12/2020 09:09	10,21	8	81,69	CHI
20201230511	MORRO AGUDO DE GOIAS	MS12113246	ITAPURANGA	06/12/2020 22:56	07/12/2020 09:09	06/12/2020 22:56	07/12/2020 09:09	10,21	7	71,48	CHI
20201230198	BALIZA	BM12390150	BOM JARDIM	06/12/2020 22:58	07/12/2020 07:25	06/12/2020 22:58	07/12/2020 07:25	8,44	33	278,59	CHI
20201230198	BOM JARDIM DE GOIAS	BM12390150	BOM JARDIM	06/12/2020 22:58	07/12/2020 07:25	06/12/2020 22:58	07/12/2020 07:25	8,44	9	75,98	CHI
20201229750	BURITI DE GOIAS	BS12332910	FIRMINOPOLIS S2	06/12/2020 23:02	07/12/2020 08:42	06/12/2020 23:02	07/12/2020 08:42	9,66	4	38,62	CHI
20201229752	URUTAI	UT12300798	URUTAI	06/12/2020 23:04	07/12/2020 01:00	06/12/2020 23:04	07/12/2020 01:00	1,93	25	48,31	CHI
20201229752	PIRES DO RIO	UT12300798	URUTAI	06/12/2020 23:04	07/12/2020 01:00	06/12/2020 23:04	07/12/2020 01:00	1,93	2	3,86	CHI
20201229754	PONTALINA	PK12092091	PONTALINA	06/12/2020 23:04	07/12/2020 09:41	06/12/2020 23:04	07/12/2020 09:41	10,61	14	148,47	CHI
20201229757	PIRACANJUBA	RQ12100189	RIO QUENTE	06/12/2020 23:05	07/12/2020 04:22	06/12/2020 23:05	07/12/2020 04:22	5,27	1	5,27	CHI
20201229757	RIO QUENTE	RQ12100189	RIO QUENTE	06/12/2020 23:05	07/12/2020 04:22	06/12/2020 23:05	07/12/2020 04:22	5,27	125	659,34	CHI
20201229757	CALDAS NOVAS	RQ12100189	RIO QUENTE	06/12/2020 23:05	07/12/2020 04:22	06/12/2020 23:05	07/12/2020 04:22	5,27	131	690,99	CHI
20201229757	MORRINHOS	RQ12100189	RIO QUENTE	06/12/2020 23:05	07/12/2020 04:22	06/12/2020 23:05	07/12/2020 04:22	5,27	8	42,20	CHI
20201229777	CALDAS NOVAS	CN21221748	RIO QUENTE	06/12/2020 23:05	07/12/2020 10:02	06/12/2020 23:05	07/12/2020 10:02	10,94	1	10,94	CHI
20201229761	SANTA HELENA DE GOIAS	SH21000255	RIO DOS BOIS	06/12/2020 23:10	07/12/2020 00:15	06/12/2020 23:10	07/12/2020 00:15	1,07	3	3,22	CHI
20201229773	SILVANIA	SV12160607	VIANOPOLIS	06/12/2020 23:12	07/12/2020 03:06	06/12/2020 23:12	07/12/2020 03:06	3,89	2	7,79	CHI
20201229774	CRIXAS	IW12032522	RUBIATABA	06/12/2020 23:12	07/12/2020 17:05	06/12/2020 23:13	07/12/2020 17:05	17,87	13	232,33	CHI
20201229774	ITAPACI	IW12032522	RUBIATABA	06/12/2020 23:12	07/12/2020 17:05	06/12/2020 23:13	07/12/2020 17:05	17,87	11	196,59	CHI
20201229774	GUARINOS	IW12032522	RUBIATABA	06/12/2020 23:12	07/12/2020 17:05	07/12/2020 16:21	07/12/2020 17:05	0,73	11	7,98	CHI
20201229774	ITAPACI	IW12032522	RUBIATABA	06/12/2020 23:12	07/12/2020 17:05	07/12/2020 16:21	07/12/2020 17:05	0,73	21	15,24	CHI
20201229778	GOIAS	GS12250578	ITABERAI S1	06/12/2020 23:15	07/12/2020 12:07	06/12/2020 23:15	07/12/2020 12:07	12,86	3	38,58	CHI
20201230503	QUIRINOPOLIS	QI32052820	QUIRINOPOLIS	06/12/2020 23:17	07/12/2020 13:27	06/12/2020 23:17	07/12/2020 11:55	12,64	20	252,74	CHI
20201230503	QUIRINOPOLIS	QI32052820	QUIRINOPOLIS	06/12/2020 23:17	07/12/2020 13:27	06/12/2020 23:17	07/12/2020 13:00	13,73	7	96,08	CHI
20201230503	QUIRINOPOLIS	QI32052820	QUIRINOPOLIS	06/12/2020 23:17	07/12/2020 13:27	06/12/2020 23:17	07/12/2020 13:27	14,16	13	184,13	CHI
20201230975	JARAGUA	JA12283464	JARAGUA	06/12/2020 23:17	07/12/2020 10:05	06/12/2020 23:17	07/12/2020 10:05	10,79	13	140,28	CHI
20201229783	ITABERAI	IB12250751	ITABERAI S1	06/12/2020 23:22	07/12/2020 07:18	06/12/2020 23:22	07/12/2020 07:18	7,93	8	63,41	CHI
20201229791	MATRINCHA	MP12065001	MATRINCHA	06/12/2020 23:30	08/12/2020 07:18	06/12/2020 23:30	08/12/2020 07:18	31,79	1	31,79	CHI
20201229793	MORRINHOS	MR21292981	MORRINHOS	06/12/2020 23:32	07/12/2020 00:53	06/12/2020 23:32	07/12/2020 00:53	1,35	1	1,35	CHI
20201229797	PIRENOPOLIS	PV12344574	CORUMBA	06/12/2020 23:34	07/12/2020 00:38	06/12/2020 23:34	07/12/2020 00:38	1,05	30	31,60	CHI
20201229815	BOM JESUS DE GOIAS	O3270414	RIO DOS BOIS	06/12/2020 23:43	07/12/2020 05:20	06/12/2020 23:43	07/12/2020 02:12	2,49	1	2,49	CHI
20201229815	MAURILANDIA	ML10407216	RIO DOS BOIS	06/12/2020 23:43	07/12/2020 05:20	06/12/2020 23:43	07/12/2020 02:12	2,49	2	4,97	CHI
20201229815	BOM JESUS DE GOIAS	O3270414	RIO DOS BOIS	06/12/2020 23:43	07/12/2020 05:20	06/12/2020 23:43	07/12/2020 05:20	5,62	5	28,11	CHI
20201229815	GOIAS	O3270414	RIO DOS BOIS	06/12/2020 23:43	07/12/2020 05:20	06/12/2020 23:43	07/12/2020 05:20	5,62	1	5,62	CHI
20201229815	CASTELANDIA	O3270414	RIO DOS BOIS	06/12/2020 23:43	07/12/2020 05:20	06/12/2020 23:43	07/12/2020 05:20	5,62	1600	8995,11	CHI
20201229815	GOIATUBA	O3270414	RIO DOS BOIS	06/12/2020 23:43	07/12/2020 05:20	06/12/2020 23:43	07/12/2020 05:20	5,62	402	2260,02	CHI
20201229815	MAURILANDIA	O3270414	RIO DOS BOIS	06/12/2020 23:43	07/12/2020 05:20	06/12/2020 23:43	07/12/2020 05:20	5,62	2	11,24	CHI
20201229815	MAURILANDIA	ML10407216	RIO DOS BOIS	06/12/2020 23:43	07/12/2020 05:20	06/12/2020 23:43	07/12/2020 05:20	5,62	11	61,84	CHI
20201229815	CASTELANDIA	O3270414	RIO DOS BOIS	06/12/2020 23:43	07/12/2020 05:20	06/12/2020 23:43	07/12/2020 05:20	5,62	1	5,62	CHI
20201229815	MAURILANDIA	O3270414	RIO DOS BOIS	06/12/2020 23:43	07/12/2020 05:20	06/12/2020 23:43	07/12/2020 05:20	5,62	4	22,49	CHI
20201229815	PORTEIRAO	O3270414	RIO DOS BOIS	06/12/2020 23:43	07/12/2020 05:20	06/12/2020 23:43	07/12/2020 05:20	5,62	6	33,73	CHI
20201229815	PORTEIRAO	O3270414	RIO DOS BOIS	06/12/2020 23:43	07/12/2020 05:20	06/12/2020 23:43	07/12/2020 05:20	5,62	7	39,35	CHI
20201229815	QUIRINOPOLIS	O3270414	RIO DOS BOIS	06/12/2020 23:43	07/12/2020 05:20	06/12/2020 23:43	07/12/2020 05:20	5,62	42	236,12	CHI
20201229815	CASTELANDIA	ML10407216	RIO DOS BOIS	06/12/2020 23:43	07/12/2020 05:20	06/12/2020 23:43	07/12/2020 05:20	5,62	2	11,24	CHI
20201229815	PORTEIRAO	O3270414	RIO DOS BOIS	06/12/2020 23:43	07/12/2020 05:20	06/12/2020 23:43	07/12/2020 05:20	5,62	4	22,49	CHI
20201229815	PORTEIRAO	O3270414	RIO DOS BOIS	06/12/2020 23:43	07/12/2020 05:20	06/12/2020 23:43	07/12/2020 05:20	5,62	2	11,24	CHI

20201229815	GOIATUBA	03270414	RIO DOS BOIS	06/12/2020 23:43	07/12/2020 05:20	06/12/2020 23:43	07/12/2020 05:20	5,62	5	28,11	CHI
20201229815	BOM JESUS DE GOIAS	03270414	RIO DOS BOIS	06/12/2020 23:43	07/12/2020 05:20	06/12/2020 23:43	07/12/2020 05:20	5,62	20	112,44	CHI
20201229815	GOIATUBA	03270414	RIO DOS BOIS	06/12/2020 23:43	07/12/2020 05:20	06/12/2020 23:43	07/12/2020 05:20	5,62	19	106,82	CHI
20201229815	GOIATUBA	03270414	RIO DOS BOIS	06/12/2020 23:43	07/12/2020 05:20	06/12/2020 23:43	07/12/2020 05:20	5,62	21	118,06	CHI
20201230773	CORUMBA DE GOIAS	CB12056813	CORUMBA	06/12/2020 23:43	07/12/2020 13:50	06/12/2020 23:43	07/12/2020 13:50	14,11	24	338,69	CHI
20201229814	CALDAS NOVAS	CN12363765	CALDAS NOVAS S1	06/12/2020 23:48	07/12/2020 03:04	06/12/2020 23:48	07/12/2020 03:04	3,27	20	65,31	CHI
20201229816	CALDAS NOVAS	CN12231992	CALDAS NOVAS S1	06/12/2020 23:48	07/12/2020 07:57	06/12/2020 23:48	07/12/2020 07:57	8,14	59	480,28	CHI
20201229817	MUNDO NOVO DE GOIAS	MH21192287	NOVA CRIXAS	06/12/2020 23:49	07/12/2020 11:27	06/12/2020 23:49	07/12/2020 11:27	11,63	1	11,63	CHI
20201229821	CHAPADAO DO CEU	DJ12160236	CHAPADAO DO CEU	07/12/2020 00:01	07/12/2020 07:33	07/12/2020 00:01	07/12/2020 07:33	7,53	7	52,68	CHI
20201229828	BARRO ALTO	BA10405238	BARRO ALTO	07/12/2020 00:03	07/12/2020 08:46	07/12/2020 00:03	07/12/2020 08:46	8,71	1205	10497,22	CHI
20201229828	SAO LUIZ DO NORTE	BA10405238	BARRO ALTO	07/12/2020 00:03	07/12/2020 08:46	07/12/2020 00:03	07/12/2020 08:46	8,71	34	296,19	CHI
20201229828	HIDROLINA	BA10405238	BARRO ALTO	07/12/2020 00:03	07/12/2020 08:46	07/12/2020 00:03	07/12/2020 08:46	8,71	1	8,71	CHI
20201229828	SANTA RITA DO NOVO DESTINO	BA10405238	BARRO ALTO	07/12/2020 00:03	07/12/2020 08:46	07/12/2020 00:03	07/12/2020 08:46	8,71	503	4381,83	CHI
20201229828	NIQUELANDIA	BA10405238	BARRO ALTO	07/12/2020 00:03	07/12/2020 08:46	07/12/2020 00:03	07/12/2020 08:46	8,71	121	1054,08	CHI
20201229950	TURVELANDIA	TD10400677	RIO DOS BOIS	07/12/2020 00:13	08/12/2020 14:00	07/12/2020 00:13	07/12/2020 08:52	8,66	1	8,66	CHI
20201229950	PORTEIRAO	TD10400677	RIO DOS BOIS	07/12/2020 00:13	08/12/2020 14:00	07/12/2020 00:13	07/12/2020 08:52	8,66	13	112,54	CHI
20201229950	PORTEIRAO	CL13030865	RIO DOS BOIS	07/12/2020 00:13	08/12/2020 14:00	07/12/2020 00:13	07/12/2020 10:57	10,73	4	42,91	CHI
20201229950	PORTEIRAO	CL13030904	RIO DOS BOIS	07/12/2020 00:13	08/12/2020 14:00	07/12/2020 00:13	07/12/2020 11:36	11,38	8	91,01	CHI
20201229950	PORTEIRAO	02650224	RIO DOS BOIS	07/12/2020 00:13	08/12/2020 14:00	07/12/2020 11:40	07/12/2020 12:50	1,16	1610	1871,63	CHI
20201229950	TURVELANDIA	TD10400677	RIO DOS BOIS	07/12/2020 00:13	08/12/2020 14:00	07/12/2020 11:40	07/12/2020 12:51	1,18	1	1,18	CHI
20201229950	PORTEIRAO	TD10400677	RIO DOS BOIS	07/12/2020 00:13	08/12/2020 14:00	07/12/2020 11:40	07/12/2020 12:51	1,18	17	20,07	CHI
20201229950	PORTEIRAO	CL16404243	RIO DOS BOIS	07/12/2020 00:13	08/12/2020 14:00	07/12/2020 11:40	08/12/2020 14:00	26,34	8	210,69	CHI
20201230168	RIO QUENTE	01240414	MORRINHOS	07/12/2020 00:18	07/12/2020 00:22	07/12/2020 00:18	07/12/2020 00:22	0,08	20	1,63	CHI
20201230168	MORRINHOS	01240414	MORRINHOS	07/12/2020 00:18	07/12/2020 00:22	07/12/2020 00:18	07/12/2020 00:22	0,08	85	6,92	CHI
20201230168	MORRINHOS	01240414	MORRINHOS	07/12/2020 00:18	07/12/2020 00:22	07/12/2020 00:18	07/12/2020 00:22	0,08	374	30,44	CHI
20201230168	MORRINHOS	01240414	MORRINHOS	07/12/2020 00:18	07/12/2020 00:22	07/12/2020 00:18	07/12/2020 00:22	0,08	240	19,53	CHI
20201230168	CALDAS NOVAS	01240414	MORRINHOS	07/12/2020 00:18	07/12/2020 00:22	07/12/2020 00:18	07/12/2020 00:22	0,08	2	0,16	CHI
20201230168	MORRINHOS	01240414	MORRINHOS	07/12/2020 00:18	07/12/2020 00:22	07/12/2020 00:19	07/12/2020 00:22	0,06	3	0,17	CHI
20201230168	MORRINHOS	01240414	MORRINHOS	07/12/2020 00:18	07/12/2020 00:22	07/12/2020 00:19	07/12/2020 00:22	0,06	1	0,06	CHI
20201230433	SAO LUIS DE MONTES BELOS	SL12004163	SAO LUIZ DOS MONTES BELOS	07/12/2020 00:23	07/12/2020 08:56	07/12/2020 00:23	07/12/2020 08:56	8,56	287	2457,28	CHI
20201229901	RIO VERDE	RV10394844	CABRIUVA S2	07/12/2020 00:27	08/12/2020 00:42	07/12/2020 00:27	07/12/2020 11:14	10,78	3	32,33	CHI
20201229901	RIO VERDE	RV10413449	CABRIUVA S2	07/12/2020 00:27	08/12/2020 00:42	07/12/2020 00:27	07/12/2020 12:44	12,28	69	847,20	CHI
20201229901	RIO VERDE	RV12365445	RIO VERDE S2	07/12/2020 00:27	08/12/2020 00:42	07/12/2020 10:27	07/12/2020 22:46	12,32	262	3226,82	CHI
20201229901	RIO VERDE	RV13350956	CABRIUVA S2	07/12/2020 00:27	08/12/2020 00:42	07/12/2020 00:27	07/12/2020 23:14	22,77	8	182,16	CHI
20201229901	RIO VERDE	RV13350955	CABRIUVA S2	07/12/2020 00:27	08/12/2020 00:42	08/12/2020 00:29	08/12/2020 00:42	0,21	3	0,64	CHI
20201230054	CORUMBAIBA	CI12263342LD	VILA CORUMBA	07/12/2020 00:44	07/12/2020 09:13	07/12/2020 00:44	07/12/2020 09:13	8,47	415	3513,78	CHI
20201230251	JUSSARA	JR12259810	BRITANIA	07/12/2020 00:53	07/12/2020 15:32	07/12/2020 00:53	07/12/2020 15:32	14,63	49	717,06	CHI
20201229906	SENADOR CANEDO	SW12329397	SENADOR CANEDO	07/12/2020 00:54	07/12/2020 02:35	07/12/2020 00:54	07/12/2020 02:35	1,67	544	907,27	CHI
20201229882	SANTA HELENA DE GOIAS	10003676127	IPEGUARI	07/12/2020 00:57	07/12/2020 07:41	07/12/2020 00:57	07/12/2020 07:41	6,72	1	6,72	CHI
20201229910	MONTIVIDIU	MV10409385	MONTIVIDIU T	07/12/2020 01:00	07/12/2020 14:43	07/12/2020 01:00	07/12/2020 08:19	7,31	10	73,12	CHI
20201229910	RIO VERDE	MV10409385	MONTIVIDIU T	07/12/2020 01:00	07/12/2020 14:43	07/12/2020 01:00	07/12/2020 08:19	7,31	7	51,18	CHI
20201229910	MONTIVIDIU	MV13106478	MONTIVIDIU T	07/12/2020 01:00	07/12/2020 14:43	07/12/2020 01:00	07/12/2020 14:43	13,73	16	219,61	CHI
20201229910	RIO VERDE	MV13106478	MONTIVIDIU T	07/12/2020 01:00	07/12/2020 14:43	07/12/2020 01:00	07/12/2020 14:43	13,73	13	178,44	CHI
20201229890	CAMPOS BELOS	10031937568	SAO DOMINGOS	07/12/2020 01:13	07/12/2020 03:51	07/12/2020 01:13	07/12/2020 03:51	2,63	1	2,63	CHI
20201229924	BELA VISTA DE GOIAS	BV12000019	BELA VISTA S1	07/12/2020 01:15	07/12/2020 03:38	07/12/2020 01:15	07/12/2020 03:38	2,38	31	73,76	CHI
20201229912	MINEIROS	1390173292	PARQUE DAS EMAS	07/12/2020 01:29	07/12/2020 09:34	07/12/2020 01:29	07/12/2020 09:34	8,07	1	8,07	CHI
20201230327	CORUMBAIBA	MG12000356	VILA CORUMBA	07/12/2020 01:44	07/12/2020 10:53	07/12/2020 01:44	07/12/2020 10:53	9,15	6	54,89	CHI
20201230327	CALDAS NOVAS	MG12000356	VILA CORUMBA	07/12/2020 01:44	07/12/2020 10:53	07/12/2020 01:44	07/12/2020 10:53	9,15	1	9,15	CHI
20201229918	CACU	CC21322238	CACHOEIRA ALTA	07/12/2020 01:45	07/12/2020 08:24	07/12/2020 01:45	07/12/2020 08:24	6,64	1	6,64	CHI
20201230014	CALDAS NOVAS	CN12213834	CALDAS NOVAS S1	07/12/2020 02:11	07/12/2020 10:11	07/12/2020 02:11	07/12/2020 10:11	7,99	4	31,98	CHI
20201229934	PIRACANJUBA	PJ21403657	ROCHEDO	07/12/2020 02:17	07/12/2020 07:16	07/12/2020 02:17	07/12/2020 07:16	4,97	1	4,97	CHI

20201229940	SILVANIA	SV21157830	VIANOPOLIS	07/12/2020 02:24	07/12/2020 05:30	07/12/2020 02:24	07/12/2020 05:30	3,10	1	3,10	CHI
20201229947	RIO VERDE	SH10400641	SANTA HELENA S1	07/12/2020 02:27	08/12/2020 14:18	07/12/2020 02:27	07/12/2020 08:38	6,17	8	49,39	CHI
20201229947	SANTA HELENA DE GOIAS	SH10400641	SANTA HELENA S1	07/12/2020 02:27	08/12/2020 14:18	07/12/2020 02:27	07/12/2020 08:38	6,17	20	123,47	CHI
20201229947	SANTA HELENA DE GOIAS	SH10400641	SANTA HELENA S1	07/12/2020 02:27	08/12/2020 14:18	07/12/2020 11:55	07/12/2020 11:58	0,05	20	1,03	CHI
20201229947	RIO VERDE	SH10400641	SANTA HELENA S1	07/12/2020 02:27	08/12/2020 14:18	07/12/2020 11:55	07/12/2020 11:58	0,05	8	0,41	CHI
20201229947	RIO VERDE	SH18301203TS	SANTA HELENA S1	07/12/2020 02:27	08/12/2020 14:18	07/12/2020 02:27	07/12/2020 12:12	9,74	24	233,86	CHI
20201229947	SANTA HELENA DE GOIAS	SH18301203TS	SANTA HELENA S1	07/12/2020 02:27	08/12/2020 14:18	07/12/2020 02:27	07/12/2020 12:12	9,74	29	282,58	CHI
20201229947	SANTA HELENA DE GOIAS	SH12000215	SANTA HELENA S1	07/12/2020 02:27	08/12/2020 14:18	07/12/2020 02:27	08/12/2020 14:18	35,84	1	35,84	CHI
20201229945	GOIANESIA	GE12000279	GOIANESIA S2	07/12/2020 02:34	07/12/2020 09:56	07/12/2020 02:34	07/12/2020 09:56	7,36	39	287,15	CHI
20201230742	CRISTALINA	KR12373074	CRISTALINA S2	07/12/2020 02:34	07/12/2020 17:52	07/12/2020 02:34	07/12/2020 17:52	15,29	8	122,34	CHI
20201231262	RIO VERDE	BZ12211442	SANTA HELENA S1	07/12/2020 02:41	07/12/2020 14:01	07/12/2020 02:41	07/12/2020 14:01	11,34	4	45,35	CHI
20201231262	SANTO ANTONIO DA BARRA	BZ12211442	SANTA HELENA S1	07/12/2020 02:41	07/12/2020 14:01	07/12/2020 02:41	07/12/2020 14:01	11,34	20	226,77	CHI
20201230339	GUARANI DE GOIAS	GY12265440	IACIARA S1	07/12/2020 02:43	07/12/2020 07:19	07/12/2020 02:43	07/12/2020 07:19	4,60	20	91,90	CHI
20201230668	GOIAS	GS12054690	GOIAS	07/12/2020 02:59	07/12/2020 09:08	07/12/2020 02:59	07/12/2020 09:08	6,14	14	86,01	CHI
20201229966	LAGOA SANTA	IJ21191581	ITAJA S2	07/12/2020 03:07	07/12/2020 08:49	07/12/2020 03:07	07/12/2020 08:49	5,69	1	5,69	CHI
20201229972	FLORES DE GOIAS	FB12257743	FLORES DE GOIAS	07/12/2020 03:17	07/12/2020 07:13	07/12/2020 03:17	07/12/2020 07:13	3,93	7	27,53	CHI
20201230169	DOVERLANDIA	DV12232326	CAIAPONIA	07/12/2020 03:17	07/12/2020 16:40	07/12/2020 03:17	07/12/2020 16:40	13,38	15	200,69	CHI
20201231414	AURILANDIA	AI12377180	FIRMINOPOLIS S2	07/12/2020 03:31	07/12/2020 10:22	07/12/2020 03:31	07/12/2020 10:22	6,84	6	41,04	CHI
20201230140	MINEIROS	MY12156849	PARQUE DAS EMAS	07/12/2020 03:45	07/12/2020 19:28	07/12/2020 03:45	07/12/2020 19:28	15,72	11	172,92	CHI
20201230439	SANTA ROSA DE GOIAS	SR12019009	INHUMAS S1	07/12/2020 03:53	07/12/2020 09:27	07/12/2020 03:53	07/12/2020 09:27	5,55	48	266,63	CHI
20201230439	TAQUARAL DE GOIAS	SR12019009	INHUMAS S1	07/12/2020 03:53	07/12/2020 09:27	07/12/2020 03:53	07/12/2020 09:27	5,55	26	144,42	CHI
20201230029	CORUMBAIBA	CI12000463RE	VILA CORUMBA	07/12/2020 03:57	07/12/2020 07:06	07/12/2020 03:57	07/12/2020 07:06	3,15	135	425,14	CHI
20201228791	QUIRINOPOLIS	GB18000209TS	QUIRINOPOLIS	07/12/2020 03:58	07/12/2020 10:05	07/12/2020 03:58	07/12/2020 10:05	6,11	84	513,36	CHI
20201228791	GOUVELANDIA	GB18000209TS	QUIRINOPOLIS	07/12/2020 03:58	07/12/2020 10:05	07/12/2020 03:58	07/12/2020 10:05	6,11	31	189,45	CHI
20201230636	PANAMA	PX12000451	GOIATUBA S1	07/12/2020 04:01	07/12/2020 11:50	07/12/2020 04:01	07/12/2020 11:50	7,81	21	163,97	CHI
20201229995	INHUMAS	IX12326257	INHUMAS S1	07/12/2020 04:15	07/12/2020 05:51	07/12/2020 04:15	07/12/2020 05:51	1,59	18	28,67	CHI
20201230166	BONOPOLIS	BX12202590	SAO MIGUEL DO ARAGUAIA	07/12/2020 04:19	07/12/2020 11:01	07/12/2020 04:19	07/12/2020 11:01	6,69	12	80,24	CHI
20201229999	BELA VISTA DE GOIAS	BV12242077	BELA VISTA S1	07/12/2020 04:21	07/12/2020 11:15	07/12/2020 04:21	07/12/2020 11:15	6,90	29	200,02	CHI
20201230000	PALMEIRAS DE GOIAS	PL12000059	PALMEIRAS	07/12/2020 04:21	07/12/2020 07:48	07/12/2020 04:21	07/12/2020 07:48	3,43	5	17,17	CHI
20201230762	ACREUNA	EU12045007	ACREUNA	07/12/2020 04:22	07/12/2020 15:15	07/12/2020 04:22	07/12/2020 15:15	10,88	4	43,52	CHI
20201234094	ACREUNA	EU12045005	ACREUNA	07/12/2020 04:22	07/12/2020 16:10	07/12/2020 04:22	07/12/2020 16:10	11,79	25	294,74	CHI
20201230809	QUIRINOPOLIS	QI12101226	QUIRINOPOLIS	07/12/2020 04:26	07/12/2020 12:46	07/12/2020 04:26	07/12/2020 12:46	8,34	18	150,20	CHI
20201230558	FORMOSA	FA12404505	ITUIQUIRA	07/12/2020 04:28	07/12/2020 11:21	07/12/2020 04:28	07/12/2020 11:21	6,87	3	20,60	CHI
20201230008	IACIARA	IA12262079	IACIARA S1	07/12/2020 04:29	07/12/2020 10:52	07/12/2020 04:29	07/12/2020 10:52	6,38	21	133,92	CHI
20201230536	ALEXANIA	AX12297691	ALEXANIA	07/12/2020 04:29	07/12/2020 09:40	07/12/2020 04:29	07/12/2020 09:40	5,18	47	243,45	CHI
20201230536	SANTO ANTONIO DO DESCOBERTO	AX12297691	ALEXANIA	07/12/2020 04:29	07/12/2020 09:40	07/12/2020 04:29	07/12/2020 09:40	5,18	1	5,18	CHI
20201231098	CRISTALINA	KR13213688	CRISTALINA S2	07/12/2020 04:35	07/12/2020 19:02	07/12/2020 13:46	07/12/2020 15:43	1,95	267	519,98	CHI
20201231098	CRISTALINA	KR12330875	CRISTALINA S2	07/12/2020 04:35	07/12/2020 19:02	07/12/2020 04:35	07/12/2020 19:02	14,44	3	43,31	CHI
20201232609	CRISTALINA	KR12320036	CRISTALINA S2	07/12/2020 04:35	07/12/2020 12:28	07/12/2020 04:35	07/12/2020 12:28	7,87	10	78,68	CHI
20201232557	MONTES CLAROS DE GOIAS	ME12124936	IPORA	07/12/2020 04:37	07/12/2020 16:00	07/12/2020 04:37	07/12/2020 16:00	11,38	10	113,76	CHI
20201233054	CORUMBAIBA	CI12035399	VILA CORUMBA	07/12/2020 04:38	07/12/2020 22:03	07/12/2020 04:38	07/12/2020 22:03	17,40	7	121,83	CHI
20201230016	INHUMAS	IN12066320	INHUMAS S2	07/12/2020 04:40	07/12/2020 07:35	07/12/2020 04:40	07/12/2020 07:35	2,90	22	63,89	CHI
20201231039	SANTA FE DE GOIAS	RN12008741	BRITANIA	07/12/2020 04:42	07/12/2020 09:59	07/12/2020 04:42	07/12/2020 09:59	5,28	6	31,70	CHI
20201230018	ANAPOLIS	AN11272978	ANAPOLIS UNIVERSITARIO S2	07/12/2020 04:43	07/12/2020 12:37	07/12/2020 04:43	07/12/2020 12:37	7,89	142	1120,42	CHI
20201230019	URUTAI	UT12300798	URUTAI	07/12/2020 04:44	07/12/2020 07:04	07/12/2020 04:44	07/12/2020 07:04	2,32	25	57,92	CHI
20201230019	PIRES DO RIO	UT12300798	URUTAI	07/12/2020 04:44	07/12/2020 07:04	07/12/2020 04:44	07/12/2020 07:04	2,32	2	4,63	CHI
20201231558	PONTALINA	PK12080054	PONTALINA	07/12/2020 04:44	07/12/2020 08:58	07/12/2020 04:44	07/12/2020 08:58	4,23	94	397,96	CHI
20201232678	JUSSARA	JR12073378	BRITANIA	07/12/2020 04:46	08/12/2020 14:55	07/12/2020 04:46	08/12/2020 14:55	34,14	5	170,70	CHI
20201230385	SANTA CRUZ DE GOIAS	PJ12212176RE	PIRACANJUBA	07/12/2020 04:47	07/12/2020 23:02	07/12/2020 04:47	07/12/2020 23:02	18,25	75	1368,73	CHI
20201230385	PIRACANJUBA	PJ12212176RE	PIRACANJUBA	07/12/2020 04:47	07/12/2020 23:02	07/12/2020 04:47	07/12/2020 23:02	18,25	14	255,50	CHI
20201230385	CRISTIANOPOLIS	PJ12212176RE	PIRACANJUBA	07/12/2020 04:47	07/12/2020 23:02	07/12/2020 04:47	07/12/2020 23:02	18,25	4	73,00	CHI

20201230025	DOVERLANDIA	DV11138403	CAIAPONIA	07/12/2020 04:54	08/12/2020 07:40	07/12/2020 04:54	08/12/2020 07:40	26,76	2	53,53	CHI
20201230026	BELA VISTA DE GOIAS	BV12514418	BELA VISTA S1	07/12/2020 04:54	07/12/2020 11:07	07/12/2020 04:54	07/12/2020 11:07	6,20	8	49,61	CHI
20201229239	JOVIANIA	VI12218198RE	VICENTINOPOLIS	07/12/2020 04:56	07/12/2020 11:39	07/12/2020 04:56	07/12/2020 11:39	6,71	12	80,46	CHI
20201229239	PONTALINA	VI12218198RE	VICENTINOPOLIS	07/12/2020 04:56	07/12/2020 11:39	07/12/2020 04:56	07/12/2020 11:39	6,71	26	174,33	CHI
20201229239	VICENTINOPOLIS	VI12218198RE	VICENTINOPOLIS	07/12/2020 04:56	07/12/2020 11:39	07/12/2020 04:56	07/12/2020 11:39	6,71	12	80,46	CHI
20201230805	ITABERAI	IB12051436	ITABERAI S1	07/12/2020 04:57	07/12/2020 10:42	07/12/2020 04:57	07/12/2020 10:42	5,75	5	28,73	CHI
20201230028	CATALAO	CT12250462	CATALAO S1	07/12/2020 04:58	07/12/2020 09:13	07/12/2020 04:58	07/12/2020 09:13	4,26	1	4,26	CHI
20201230640	PIRACANJUBA	PJ12000121	PIRACANJUBA	07/12/2020 05:00	07/12/2020 08:02	07/12/2020 05:00	07/12/2020 08:02	3,02	38	114,67	CHI
20201230640	HIDROLANDIA	PJ12000121	PIRACANJUBA	07/12/2020 05:00	07/12/2020 08:02	07/12/2020 05:00	07/12/2020 08:02	3,02	7	21,12	CHI
20201230034	FORMOSA	FA12282335	ITUIQUIRA	07/12/2020 05:02	07/12/2020 10:36	07/12/2020 05:02	07/12/2020 10:36	5,56	6	33,33	CHI
20201231002	JARAGUA	IC12027950	ITABERAI S1	07/12/2020 05:02	07/12/2020 13:45	07/12/2020 05:02	07/12/2020 13:45	8,70	13	113,13	CHI
20201231002	ITAGUARU	IC12027950	ITABERAI S1	07/12/2020 05:02	07/12/2020 13:45	07/12/2020 05:02	07/12/2020 13:45	8,70	12	104,42	CHI
20201230324	ALTO HORIZONTE	AJ12398008LD	SANTA TEREZINHA	07/12/2020 05:03	07/12/2020 17:13	07/12/2020 05:03	07/12/2020 17:13	12,16	47	571,64	CHI
20201230161	PALESTINA DE GOIAS	CP12207858	PALESTINA	07/12/2020 05:07	07/12/2020 16:07	07/12/2020 05:07	07/12/2020 16:07	11,00	1	11,00	CHI
20201230161	CAIAPONIA	CP12207858	PALESTINA	07/12/2020 05:07	07/12/2020 16:07	07/12/2020 05:07	07/12/2020 16:07	11,00	22	241,98	CHI
20201230042	JUSSARA	RN12250752	BRITANIA	07/12/2020 05:08	07/12/2020 09:25	07/12/2020 05:08	07/12/2020 09:25	4,28	19	81,23	CHI
20201230042	SANTA FE DE GOIAS	RN12250752	BRITANIA	07/12/2020 05:08	07/12/2020 09:25	07/12/2020 05:08	07/12/2020 09:25	4,28	43	183,84	CHI
20201230058	SANTO ANTONIO DO DESCOBERTO	SN11168710	ALEXANIA	07/12/2020 05:08	07/12/2020 09:34	07/12/2020 05:08	07/12/2020 09:34	4,43	115	509,64	CHI
20201230594	MINEIROS	MY12303820	PARQUE DAS EMAS	07/12/2020 05:10	07/12/2020 19:23	07/12/2020 05:10	07/12/2020 19:23	14,21	29	412,09	CHI
20201230594	SANTA RITA DO ARAGUAIA	MY12303820	PARQUE DAS EMAS	07/12/2020 05:10	07/12/2020 19:23	07/12/2020 05:10	07/12/2020 19:23	14,21	2	28,42	CHI
20201231989	FAINA	FC12147802	GOIAS	07/12/2020 05:11	07/12/2020 11:59	07/12/2020 05:11	07/12/2020 11:59	6,80	13	88,35	CHI
20201230046	MINEIROS	MY21195604	PARQUE DAS EMAS	07/12/2020 05:12	07/12/2020 21:58	07/12/2020 05:12	07/12/2020 21:58	16,78	1	16,78	CHI
20201230047	BELA VISTA DE GOIAS	BV12291753RE	BELA VISTA S1	07/12/2020 05:12	07/12/2020 08:35	07/12/2020 05:12	07/12/2020 08:35	3,37	88	296,98	CHI
20201230747	CORUMBAlBA	CI12377063	CATALAO S1	07/12/2020 05:16	07/12/2020 12:33	07/12/2020 05:16	07/12/2020 12:33	7,27	10	72,69	CHI
20201230055	ABADIA DE GOIAS	5583681437	CARAJAS S1	07/12/2020 05:17	07/12/2020 08:51	07/12/2020 05:17	07/12/2020 08:51	3,55	1	3,55	CHI
20201230466	GOIANDIRA	GD12131094	CATALAO S1	07/12/2020 05:18	07/12/2020 08:10	07/12/2020 05:18	07/12/2020 08:10	2,86	7	20,04	CHI
20201230466	NOVA AURORA	GD12131094	CATALAO S1	07/12/2020 05:18	07/12/2020 08:10	07/12/2020 05:18	07/12/2020 08:10	2,86	2	5,72	CHI
20201230060	ADELANDIA	DN12259954	ANICUNS	07/12/2020 05:19	07/12/2020 08:45	07/12/2020 05:19	07/12/2020 08:45	3,42	5	17,12	CHI
20201230060	MOSSAMEDES	DN12259954	ANICUNS	07/12/2020 05:19	07/12/2020 08:45	07/12/2020 05:19	07/12/2020 08:45	3,42	1	3,42	CHI
20201230063	LUZANIA	LZ12072234	VIANOPOLIS	07/12/2020 05:20	07/12/2020 10:32	07/12/2020 05:20	07/12/2020 10:32	5,20	4	20,79	CHI
20201230065	CORREGO DO OURO	CO12054528	FIRMINOPOLIS S2	07/12/2020 05:21	07/12/2020 07:19	07/12/2020 05:21	07/12/2020 07:19	1,96	9	17,66	CHI
20201230069	MINEIROS	MY12390605RE	PARQUE DAS EMAS	07/12/2020 05:24	07/12/2020 10:30	07/12/2020 05:24	07/12/2020 10:30	5,10	16	81,53	CHI
20201230073	VILA PROPICIO	NP12339454	GOIANESIA S1	07/12/2020 05:26	08/12/2020 20:55	07/12/2020 05:26	08/12/2020 14:34	33,15	5	165,74	CHI
20201230073	VILA PROPICIO	NP12339454	GOIANESIA S1	07/12/2020 05:26	08/12/2020 20:55	07/12/2020 05:26	08/12/2020 14:44	33,30	97	3230,42	CHI
20201230073	VILA PROPICIO	NP12339454	GOIANESIA S1	07/12/2020 05:26	08/12/2020 20:55	07/12/2020 05:26	08/12/2020 15:13	33,78	10	337,83	CHI
20201230073	VILA PROPICIO	BA21196866	GOIANESIA S1	07/12/2020 05:26	08/12/2020 20:55	08/12/2020 14:37	08/12/2020 20:55	6,30	1	6,30	CHI
20201230074	PARANAIGUARA	PC12209794	QUIRINOPOLIS	07/12/2020 05:26	07/12/2020 10:13	07/12/2020 05:26	07/12/2020 10:13	4,78	7	33,46	CHI
20201230075	SILVANIA	XX16879338	VIANOPOLIS	07/12/2020 05:26	07/12/2020 08:41	07/12/2020 05:26	07/12/2020 08:41	3,24	2	6,49	CHI
20201230646	PIRENOPOLIS	PV12014768	SAO FRANCISCO DE GOIAS	07/12/2020 05:27	07/12/2020 11:27	07/12/2020 05:27	07/12/2020 11:27	5,98	7	41,89	CHI
20201230332	RIO VERDE	O1690224	ACREUNA	07/12/2020 05:28	08/12/2020 21:23	07/12/2020 05:30	07/12/2020 08:57	3,44	0	0,00	CHI
20201230332	SANTO ANTONIO DA BARRA	O1690224	ACREUNA	07/12/2020 05:28	08/12/2020 21:23	07/12/2020 05:30	07/12/2020 08:57	3,44	25	86,10	CHI
20201230332	SANTA HELENA DE GOIAS	BZ12219419LD	ACREUNA	07/12/2020 05:28	08/12/2020 21:23	07/12/2020 05:30	07/12/2020 13:33	8,06	4	32,23	CHI
20201230332	SANTO ANTONIO DA BARRA	BZ12219419LD	ACREUNA	07/12/2020 05:28	08/12/2020 21:23	07/12/2020 05:30	07/12/2020 13:33	8,06	11	88,63	CHI
20201230332	SANTA HELENA DE GOIAS	BZ12295808LD	ACREUNA	07/12/2020 05:28	08/12/2020 21:23	07/12/2020 05:30	07/12/2020 14:26	8,94	5	44,69	CHI
20201230332	RIO VERDE	BZ12295808LD	ACREUNA	07/12/2020 05:28	08/12/2020 21:23	07/12/2020 05:30	07/12/2020 14:26	8,94	25	223,44	CHI
20201230332	SANTO ANTONIO DA BARRA	BZ12295808LD	ACREUNA	07/12/2020 05:28	08/12/2020 21:23	07/12/2020 05:30	07/12/2020 14:26	8,94	146	1304,88	CHI
20201230332	ACREUNA	SH12246720	ACREUNA	07/12/2020 05:28	08/12/2020 21:23	07/12/2020 05:30	08/12/2020 21:23	39,89	5	199,43	CHI
20201230332	SANTA HELENA DE GOIAS	SH12246720	ACREUNA	07/12/2020 05:28	08/12/2020 21:23	07/12/2020 05:30	08/12/2020 21:23	39,89	77	3071,23	CHI
20201230332	SANTO ANTONIO DA BARRA	SH12246720	ACREUNA	07/12/2020 05:28	08/12/2020 21:23	07/12/2020 05:30	08/12/2020 21:23	39,89	16	638,18	CHI
20201231803	CRISTALINA	KR12039306	CRISTALINA S1	07/12/2020 05:31	07/12/2020 14:55	07/12/2020 05:31	07/12/2020 14:55	9,39	2	18,79	CHI
20201230086	JOVIANIA	JV12034737	GOIATUBA S1	07/12/2020 05:32	08/12/2020 08:25	07/12/2020 05:32	08/12/2020 08:25	26,88	3	80,65	CHI

20201230088	FORMOSA	610190696	ITIQUEIRA	07/12/2020 05:32	07/12/2020 16:06	07/12/2020 05:32	07/12/2020 16:06	10,55	1	10,55	CHI
20201230360	CORUMBAIBA	CI12263856	VILA CORUMBA	07/12/2020 05:33	07/12/2020 10:19	07/12/2020 05:33	07/12/2020 10:19	4,77	168	801,08	CHI
20201230360	NOVA AURORA	CI12263856	VILA CORUMBA	07/12/2020 05:33	07/12/2020 10:19	07/12/2020 05:33	07/12/2020 10:19	4,77	7	33,38	CHI
20201230091	JARAGUA	JA12273002	JARAGUA	07/12/2020 05:34	07/12/2020 10:41	07/12/2020 05:34	07/12/2020 10:41	5,11	25	127,74	CHI
20201230092	LUZIANIA	LZ12396835	MARAJOARA	07/12/2020 05:34	07/12/2020 10:37	07/12/2020 05:34	07/12/2020 10:37	5,04	27	136,12	CHI
20201230095	IACIARA	IA21317966	IACIARA S2	07/12/2020 05:36	07/12/2020 11:39	07/12/2020 05:36	07/12/2020 11:39	6,04	1	6,04	CHI
20201230096	GOIANESIA	GE12185738	GOIANESIA S2	07/12/2020 05:36	07/12/2020 18:00	07/12/2020 05:36	07/12/2020 18:00	12,40	14	173,56	CHI
20201230099	CUMARI	AH12082018	CATALAO S1	07/12/2020 05:37	07/12/2020 08:44	07/12/2020 05:37	07/12/2020 08:44	3,10	18	55,88	CHI
20201230106	CATALAO	IP12222966	IPAMERI	07/12/2020 05:37	07/12/2020 08:06	07/12/2020 05:37	07/12/2020 08:06	2,48	2	4,95	CHI
20201230106	IPAMERI	IP12222966	IPAMERI	07/12/2020 05:37	07/12/2020 08:06	07/12/2020 05:37	07/12/2020 08:06	2,48	5	12,38	CHI
20201230329	SANTA FE DE GOIAS	RN12009764	BRITANIA	07/12/2020 05:37	07/12/2020 16:33	07/12/2020 05:37	07/12/2020 16:33	10,93	6	65,56	CHI
20201230876	IVOLANDIA	IV12358531	IPORA	07/12/2020 05:38	08/12/2020 02:14	07/12/2020 05:38	08/12/2020 02:14	20,59	16	329,52	CHI
20201230798	CEZARINA	CZ12010374	CEZARINA	07/12/2020 05:39	07/12/2020 18:08	07/12/2020 05:39	07/12/2020 18:08	12,48	8	99,80	CHI
20201230105	AMARALINA	LC21278476	MARA ROSA	07/12/2020 05:40	07/12/2020 15:57	07/12/2020 05:40	07/12/2020 15:57	10,28	1	10,28	CHI
20201231664	CROMINIA	JS12000113	ROCHEDO	07/12/2020 05:40	07/12/2020 10:15	07/12/2020 05:40	07/12/2020 10:15	4,57	24	109,65	CHI
20201231664	PROFESSOR JAMIL SAFADY	JS12000113	ROCHEDO	07/12/2020 05:40	07/12/2020 10:15	07/12/2020 05:40	07/12/2020 10:15	4,57	49	223,88	CHI
20201230147	NOVO BRASIL	NB12020229	JUSSARA	07/12/2020 05:41	07/12/2020 09:13	07/12/2020 05:41	07/12/2020 09:13	3,53	25	88,25	CHI
20201230147	FAZENDA NOVA	NB12020229	JUSSARA	07/12/2020 05:41	07/12/2020 09:13	07/12/2020 05:41	07/12/2020 09:13	3,53	12	42,36	CHI
20201230951	PIRENOPOLIS	ZN12273387	COCALZINHO	07/12/2020 05:41	07/12/2020 11:15	07/12/2020 05:41	07/12/2020 11:15	5,56	15	83,36	CHI
20201230112	ABADIANIA	AA12333151	DAIA S2	07/12/2020 05:44	07/12/2020 13:20	07/12/2020 05:44	07/12/2020 11:40	5,93	19	112,65	CHI
20201230112	ABADIANIA	AA12333151	DAIA S2	07/12/2020 05:44	07/12/2020 13:20	07/12/2020 05:44	07/12/2020 12:07	6,38	2	12,76	CHI
20201230112	ABADIANIA	AA12333151	DAIA S2	07/12/2020 05:44	07/12/2020 13:20	07/12/2020 05:44	07/12/2020 13:20	7,60	4	30,38	CHI
20201230113	NOVO BRASIL	NB21091073	JUSSARA	07/12/2020 05:46	07/12/2020 07:50	07/12/2020 05:46	07/12/2020 07:50	2,06	1	2,06	CHI
20201230257	CAIAPONIA	CP12245300	CAIAPONIA	07/12/2020 05:48	07/12/2020 10:36	07/12/2020 05:48	07/12/2020 10:36	4,79	38	181,89	CHI
20201231648	ITAPIRAPUA	IU11172040	MATRINCHA	07/12/2020 05:48	07/12/2020 13:28	07/12/2020 05:48	07/12/2020 13:28	7,66	82	627,89	CHI
20201230540	JUSSARA	JR11009934	JUSSARA	07/12/2020 05:49	07/12/2020 09:05	07/12/2020 05:49	07/12/2020 09:05	3,26	107	348,55	CHI
20201230124	PLANALTINA	PI12324319	SAO JOAO D ALIANCA	07/12/2020 05:50	07/12/2020 12:11	07/12/2020 05:50	07/12/2020 12:11	6,34	2	12,68	CHI
20201233230	PLANALTINA	PI12361294	SAO JOAO D ALIANCA	07/12/2020 05:50	07/12/2020 13:32	07/12/2020 05:50	07/12/2020 13:32	7,69	6	46,14	CHI
20201230136	ESTRELA DO NORTE	MU12391986	MARA ROSA	07/12/2020 05:51	07/12/2020 10:27	07/12/2020 05:51	07/12/2020 10:27	4,60	1	4,60	CHI
20201230136	MUTUNOPOLIS	MU12391986	MARA ROSA	07/12/2020 05:51	07/12/2020 10:27	07/12/2020 05:51	07/12/2020 10:27	4,60	99	455,32	CHI
20201230346	ORIZONA	OZ1239554RE	PIRES DO RIO S2	07/12/2020 05:51	07/12/2020 08:44	07/12/2020 05:51	07/12/2020 08:44	2,87	26	74,70	CHI
20201230346	IPAMERI	OZ1239554RE	PIRES DO RIO S2	07/12/2020 05:51	07/12/2020 08:44	07/12/2020 05:51	07/12/2020 08:44	2,87	10	28,73	CHI
20201230132	CABECEIRAS	CW12129741	ITIQUEIRA	07/12/2020 05:52	07/12/2020 07:53	07/12/2020 05:52	07/12/2020 07:53	2,02	4	8,06	CHI
20201230133	ITAPACI	IW12285055	ITAPACI	07/12/2020 05:52	07/12/2020 09:25	07/12/2020 05:52	07/12/2020 09:25	3,55	1	3,55	CHI
20201230983	ORIZONA	OZ12186210	PIRES DO RIO S2	07/12/2020 05:52	07/12/2020 11:19	07/12/2020 05:52	07/12/2020 11:19	5,46	22	120,09	CHI
20201230138	RUBIATABA	RB21057014	RUBIATABA	07/12/2020 05:53	07/12/2020 10:42	07/12/2020 05:53	07/12/2020 10:42	4,82	1	4,82	CHI
20201230139	PONTALINA	MR12223454RE	MORRINHOS	07/12/2020 05:53	07/12/2020 09:01	07/12/2020 05:53	07/12/2020 09:01	3,12	5	15,60	CHI
20201230139	MORRINHOS	MR12223454RE	MORRINHOS	07/12/2020 05:53	07/12/2020 09:01	07/12/2020 05:53	07/12/2020 09:01	3,12	14	43,68	CHI
20201230277	SAO DOMINGOS	GH12241928	SAO DOMINGOS	07/12/2020 05:53	07/12/2020 11:53	07/12/2020 05:53	07/12/2020 11:53	5,98	13	77,80	CHI
20201230277	DIVINOPOLIS DE GOIAS	GH12241928	SAO DOMINGOS	07/12/2020 05:53	07/12/2020 11:53	07/12/2020 05:53	07/12/2020 11:53	5,98	41	245,36	CHI
20201230277	MONTE ALEGRE DE GOIAS	GH12241928	SAO DOMINGOS	07/12/2020 05:53	07/12/2020 11:53	07/12/2020 05:53	07/12/2020 11:53	5,98	2	11,97	CHI
20201230143	BRITANIA	BT12060643	BRITANIA	07/12/2020 05:54	07/12/2020 10:15	07/12/2020 05:54	07/12/2020 10:15	4,34	13	56,42	CHI
20201230908	PIRACANJUBA	PJ12072600	PIRACANJUBA	07/12/2020 05:55	07/12/2020 08:59	07/12/2020 05:55	07/12/2020 08:59	3,06	4	12,23	CHI
20201230148	OUVIDOR	CT12266103	CATALAO S1	07/12/2020 05:56	07/12/2020 08:17	07/12/2020 05:56	07/12/2020 08:17	2,34	5	11,71	CHI
20201230148	CATALAO	CT12266103	CATALAO S1	07/12/2020 05:56	07/12/2020 08:17	07/12/2020 05:56	07/12/2020 08:17	2,34	2	4,68	CHI
20201230148	DAVINOPOLIS	CT12266103	CATALAO S1	07/12/2020 05:56	07/12/2020 08:17	07/12/2020 05:56	07/12/2020 08:17	2,34	27	63,25	CHI
20201230154	ARAGOIANIA	AO12221194	INDEPENDENCIA S2	07/12/2020 05:57	07/12/2020 09:04	07/12/2020 05:57	07/12/2020 09:04	3,10	15	46,54	CHI
20201230290	APORE	IJ12131593	ITAJA S2	07/12/2020 05:57	07/12/2020 08:10	07/12/2020 05:57	07/12/2020 08:10	2,21	1	2,21	CHI
20201230290	ITAJA	IJ12131593	ITAJA S2	07/12/2020 05:57	07/12/2020 08:10	07/12/2020 05:57	07/12/2020 08:10	2,21	10	22,08	CHI
20201230156	JUSSARA	JR12019314	JUSSARA	07/12/2020 05:58	07/12/2020 13:52	07/12/2020 05:58	07/12/2020 13:52	7,89	83	654,85	CHI
20201231375	CRISTALINA	KR12162511	CRISTALINA S2	07/12/2020 05:58	07/12/2020 20:06	07/12/2020 05:58	07/12/2020 20:06	14,13	9	127,18	CHI

20201230160	MONTIVIDIU DO NORTE	MX12192266RE	PORANGATU	07/12/2020 05:59	08/12/2020 16:24	07/12/2020 05:59	07/12/2020 20:21	14,36	6	86,14	CHI
20201230160	MONTIVIDIU DO NORTE	MX12192266RE	PORANGATU	07/12/2020 05:59	08/12/2020 16:24	07/12/2020 05:59	08/12/2020 11:35	29,59	41	1213,09	CHI
20201230160	TROMBAS	MX12192266RE	PORANGATU	07/12/2020 05:59	08/12/2020 16:24	07/12/2020 05:59	08/12/2020 11:35	29,59	18	532,57	CHI
20201230160	MONTIVIDIU DO NORTE	MX12192266RE	PORANGATU	07/12/2020 05:59	08/12/2020 16:24	07/12/2020 05:59	08/12/2020 15:08	33,14	15	497,09	CHI
20201230160	TROMBAS	MX12192266RE	PORANGATU	07/12/2020 05:59	08/12/2020 16:24	07/12/2020 05:59	08/12/2020 15:08	33,14	1	33,14	CHI
20201230160	TROMBAS	MX12192266RE	PORANGATU	07/12/2020 05:59	08/12/2020 16:24	07/12/2020 05:59	08/12/2020 16:24	34,40	5	172,02	CHI
20201235853	PONTALINA	PK21293119	PONTALINA	07/12/2020 05:59	08/12/2020 03:12	07/12/2020 05:59	08/12/2020 03:12	21,21	1	21,21	CHI
20201230164	CATALAO	10025166660	CATALAO S2	07/12/2020 06:00	07/12/2020 09:57	07/12/2020 06:00	07/12/2020 09:57	3,94	1	3,94	CHI
20201230165	GOIANIA	15315060	GOIANIA LESTE S2	07/12/2020 06:00	07/12/2020 07:24	07/12/2020 06:00	07/12/2020 07:24	1,39	1	1,39	CHI
20201230170	LEOPOLDO DE BULHOES	LB12351258	DAIA S2	07/12/2020 06:01	07/12/2020 07:29	07/12/2020 06:01	07/12/2020 07:29	1,46	9	13,10	CHI
20201230501	RIO QUENTE	RQ12100108	RIO QUENTE	07/12/2020 06:01	07/12/2020 07:51	07/12/2020 06:01	07/12/2020 07:51	1,82	8	14,55	CHI
20201230948	TRINDADE	TR11129011	TRINDADE	07/12/2020 06:01	07/12/2020 12:48	07/12/2020 06:01	07/12/2020 12:48	6,78	44	298,42	CHI
20201230174	MORRINHOS	MR12000194	MORRINHOS	07/12/2020 06:02	07/12/2020 09:48	07/12/2020 06:02	07/12/2020 09:48	3,77	36	135,57	CHI
20201230180	CRISTALINA	KR21248643	CRISTALINA S1	07/12/2020 06:02	07/12/2020 13:39	07/12/2020 06:02	07/12/2020 13:39	7,61	2	15,21	CHI
20201230371	TURVANIA	TV12005573LD	FIRMINOPOLIS S2	07/12/2020 06:02	07/12/2020 19:00	07/12/2020 06:02	07/12/2020 11:32	5,51	27	148,70	CHI
20201230371	PALMEIRAS DE GOIAS	TV12005573LD	FIRMINOPOLIS S2	07/12/2020 06:02	07/12/2020 19:00	07/12/2020 06:02	07/12/2020 11:32	5,51	47	258,85	CHI
20201230371	PALMINOPOLIS	TV12005573LD	FIRMINOPOLIS S2	07/12/2020 06:02	07/12/2020 19:00	07/12/2020 06:02	07/12/2020 11:32	5,51	44	242,33	CHI
20201230371	PALMEIRAS DE GOIAS	TV12005573LD	FIRMINOPOLIS S2	07/12/2020 06:02	07/12/2020 19:00	07/12/2020 06:02	07/12/2020 19:00	12,98	39	506,08	CHI
20201230371	TURVANIA	TV12005573LD	FIRMINOPOLIS S2	07/12/2020 06:02	07/12/2020 19:00	07/12/2020 06:02	07/12/2020 19:00	12,98	41	532,03	CHI
20201230371	NAZARIO	TV12005573LD	FIRMINOPOLIS S2	07/12/2020 06:02	07/12/2020 19:00	07/12/2020 06:02	07/12/2020 19:00	12,98	6	77,86	CHI
20201230450	MUNDO NOVO DE GOIAS	MH12357676	NOVA CRIXAS	07/12/2020 06:02	07/12/2020 08:31	07/12/2020 06:02	07/12/2020 08:31	2,48	24	59,50	CHI
20201231535	CALDAS NOVAS	CN12404748	CALDAS NOVAS S1	07/12/2020 06:02	07/12/2020 14:50	07/12/2020 06:02	07/12/2020 14:23	8,36	6	50,13	CHI
20201231535	RIO QUENTE	CN12404748	CALDAS NOVAS S1	07/12/2020 06:02	07/12/2020 14:50	07/12/2020 06:02	07/12/2020 14:50	8,79	41	360,45	CHI
20201230187	SANTO ANTONIO DO DESCOBERTO	SN12345967	AGUAS LINDAS DE GOIAS S2	07/12/2020 06:04	07/12/2020 11:57	07/12/2020 06:04	07/12/2020 11:57	5,88	1	5,88	CHI
20201230188	EDEIA	EA12105005	VICENTINOPOLIS	07/12/2020 06:04	07/12/2020 13:50	07/12/2020 06:04	07/12/2020 13:50	7,76	4	31,04	CHI
20201230188	EDEALINA	EA12105005	VICENTINOPOLIS	07/12/2020 06:04	07/12/2020 13:50	07/12/2020 06:04	07/12/2020 13:50	7,76	3	23,28	CHI
20201230191	URUTAI	UT12417470	PIRES DO RIO S2	07/12/2020 06:04	07/12/2020 07:48	07/12/2020 06:04	07/12/2020 07:48	1,72	4	6,89	CHI
20201230236	NOVA ROMA	ND12256420	IACIARA S2	07/12/2020 06:04	07/12/2020 12:19	07/12/2020 06:04	07/12/2020 12:19	6,24	30	187,23	CHI
20201230197	LUZIANIA	LZ21087169	CRISTALINA S2	07/12/2020 06:05	07/12/2020 11:11	07/12/2020 06:05	07/12/2020 11:11	5,10	3	15,29	CHI
20201230204	INHUMAS	IN12247252	INHUMAS S1	07/12/2020 06:05	07/12/2020 08:01	07/12/2020 06:05	07/12/2020 08:01	1,92	4	7,67	CHI
20201230370	NOVA CRIXAS	NA12035650	NOVA CRIXAS	07/12/2020 06:05	07/12/2020 09:27	07/12/2020 06:05	07/12/2020 09:27	3,36	24	80,65	CHI
20201230370	MUNDO NOVO DE GOIAS	NA12035650	NOVA CRIXAS	07/12/2020 06:05	07/12/2020 09:27	07/12/2020 06:05	07/12/2020 09:27	3,36	8	26,88	CHI
20201230415	SAO JOAO D ALIANCA	JL12049201	SAO JOAO D ALIANCA	07/12/2020 06:05	07/12/2020 16:58	07/12/2020 06:05	07/12/2020 12:48	6,72	53	355,97	CHI
20201230415	SAO JOAO D ALIANCA	JL12049201	SAO JOAO D ALIANCA	07/12/2020 06:05	07/12/2020 16:58	07/12/2020 06:05	07/12/2020 16:58	10,88	38	413,56	CHI
20201230698	PARAUNA	PU12081329	PARAUNA	07/12/2020 06:05	07/12/2020 11:44	07/12/2020 06:05	07/12/2020 10:20	4,25	30	127,46	CHI
20201230698	PARAUNA	PU12336680	PARAUNA	07/12/2020 06:05	07/12/2020 11:44	07/12/2020 06:05	07/12/2020 11:44	5,64	41	231,44	CHI
20201230867	TRINDADE	TR11091182	TRINDADE	07/12/2020 06:05	07/12/2020 09:18	07/12/2020 06:05	07/12/2020 09:18	3,21	110	352,79	CHI
20201227182	FAINA	FC12345744	GOIAS	07/12/2020 06:06	07/12/2020 11:00	07/12/2020 06:06	07/12/2020 11:00	4,90	7	34,27	CHI
20201230209	ARAGUAPAZ	AZ12064165	GOIAS	07/12/2020 06:06	07/12/2020 08:37	07/12/2020 06:06	07/12/2020 08:37	2,51	4	10,04	CHI
20201230211	TRES RANCHOS	OU12000352	CATALAO S1	07/12/2020 06:06	07/12/2020 09:17	07/12/2020 06:06	07/12/2020 09:17	3,17	6	19,03	CHI
20201230211	OUVIDOR	OU12000352	CATALAO S1	07/12/2020 06:06	07/12/2020 09:17	07/12/2020 06:06	07/12/2020 09:17	3,17	31	98,32	CHI
20201230213	ESTRELA DO NORTE	ET21136399	MARA ROSA	07/12/2020 06:06	07/12/2020 19:45	07/12/2020 06:06	07/12/2020 19:45	13,64	2	27,27	CHI
20201230214	PIRACANJUBA	PJ21056106	PIRACANJUBA	07/12/2020 06:06	08/12/2020 08:43	07/12/2020 06:06	08/12/2020 08:43	26,60	1	26,60	CHI
20201230248	MONTES CLAROS DE GOIAS	ME12029537	BRITANIA	07/12/2020 06:06	07/12/2020 15:15	07/12/2020 06:06	07/12/2020 15:15	9,14	13	118,81	CHI
20201231005	TAQUARAL DE GOIAS	IX12016021	INHUMAS S1	07/12/2020 06:06	08/12/2020 11:19	07/12/2020 11:55	07/12/2020 12:22	0,44	9	3,95	CHI
20201231005	ITAUCU	IX12016021	INHUMAS S1	07/12/2020 06:06	08/12/2020 11:19	07/12/2020 11:55	07/12/2020 12:22	0,44	49	21,51	CHI
20201231005	TAQUARAL DE GOIAS	TQ12250778	INHUMAS S1	07/12/2020 06:06	08/12/2020 11:19	07/12/2020 06:06	07/12/2020 15:39	9,55	25	238,82	CHI
20201231005	TAQUARAL DE GOIAS	TQ12250778	INHUMAS S1	07/12/2020 06:06	08/12/2020 11:19	07/12/2020 06:06	08/12/2020 09:43	27,61	2	55,23	CHI
20201231005	TAQUARAL DE GOIAS	TQ12250778	INHUMAS S1	07/12/2020 06:06	08/12/2020 11:19	07/12/2020 06:06	08/12/2020 10:47	28,68	4	114,71	CHI
20201231005	TAQUARAL DE GOIAS	TQ12250778	INHUMAS S1	07/12/2020 06:06	08/12/2020 11:19	07/12/2020 06:06	08/12/2020 11:19	29,22	8	233,79	CHI
20201231434	SANTA FE DE GOIAS	RN11250633	BRITANIA	07/12/2020 06:06	07/12/2020 11:12	07/12/2020 06:06	07/12/2020 11:12	5,10	58	295,62	CHI

20201230217	PORANGATU	PO21345597	PORANGATU	07/12/2020 06:07	07/12/2020 09:44	07/12/2020 06:07	07/12/2020 09:44	3,61	1	3,61	CHI
20201230219	EDEIA	EA12000059RE	EDEIA	07/12/2020 06:07	07/12/2020 11:51	07/12/2020 06:07	07/12/2020 11:51	5,73	92	526,78	CHI
20201230220	BARRO ALTO	BA12210734	BARRO ALTO	07/12/2020 06:07	07/12/2020 15:02	07/12/2020 06:07	07/12/2020 15:02	8,91	4	35,63	CHI
20201230221	CAMPOS VERDES	VD12065501	SANTA TEREZINHA	07/12/2020 06:07	07/12/2020 18:49	07/12/2020 06:07	07/12/2020 18:49	12,69	2	25,37	CHI
20201230225	NOVA IGUACU DE GOIAS	NH12243460RE	SANTA TEREZINHA	07/12/2020 06:07	09/12/2020 09:00	07/12/2020 06:07	07/12/2020 15:17	9,17	36	330,02	CHI
20201230225	NOVA IGUACU DE GOIAS	NH12243460RE	SANTA TEREZINHA	07/12/2020 06:07	09/12/2020 09:00	07/12/2020 06:07	09/12/2020 09:00	50,88	3	152,65	CHI
20201230225	NOVA IGUACU DE GOIAS	NH12243422LD	SANTA TEREZINHA	07/12/2020 06:07	09/12/2020 09:00	08/12/2020 21:09	09/12/2020 09:00	11,85	32	379,24	CHI
20201231302	BELA VISTA DE GOIAS	BV12202366	BELA VISTA S2	07/12/2020 06:07	07/12/2020 14:00	07/12/2020 06:07	07/12/2020 14:00	7,88	9	70,90	CHI
20201230230	ADELANDIA	DN21152995	FIRMINOPOLIS S2	07/12/2020 06:08	07/12/2020 07:45	07/12/2020 06:08	07/12/2020 07:45	1,61	1	1,61	CHI
20201230350	PARAUNA	PU12391518	PARAUNA	07/12/2020 06:08	07/12/2020 15:51	07/12/2020 06:08	07/12/2020 15:51	9,70	26	252,32	CHI
20201230838	GOIAS	GS12037486	ITABERAI S1	07/12/2020 06:08	07/12/2020 11:30	07/12/2020 06:08	07/12/2020 11:30	5,36	20	107,27	CHI
20201230241	INDIARA	IY10395372	CEZARINA	07/12/2020 06:09	08/12/2020 10:14	07/12/2020 06:09	07/12/2020 10:48	4,65	16	74,38	CHI
20201230241	INDIARA	IY10395372	CEZARINA	07/12/2020 06:09	08/12/2020 10:14	07/12/2020 09:30	07/12/2020 10:48	1,31	5	6,57	CHI
20201230241	INDIARA	IY10395372	CEZARINA	07/12/2020 06:09	08/12/2020 10:14	07/12/2020 10:55	07/12/2020 11:33	0,65	16	10,32	CHI
20201230241	INDIARA	IY10395372	CEZARINA	07/12/2020 06:09	08/12/2020 10:14	07/12/2020 11:40	07/12/2020 12:19	0,66	4	2,64	CHI
20201230241	INDIARA	IY10400410	EDEIA	07/12/2020 06:09	08/12/2020 10:14	07/12/2020 13:38	07/12/2020 13:46	0,14	5	0,68	CHI
20201230241	INDIARA	IY10395372	CEZARINA	07/12/2020 06:09	08/12/2020 10:14	07/12/2020 06:09	07/12/2020 19:34	13,40	21	281,46	CHI
20201230241	INDIARA	IY13400609B	CEZARINA	07/12/2020 06:09	08/12/2020 10:14	07/12/2020 09:30	07/12/2020 19:34	10,07	2	20,14	CHI
20201230241	INDIARA	IY13400609B	CEZARINA	07/12/2020 06:09	08/12/2020 10:14	07/12/2020 10:55	07/12/2020 19:34	8,65	1	8,65	CHI
20201230241	INDIARA	IY12206402	CEZARINA	07/12/2020 06:09	08/12/2020 10:14	07/12/2020 10:55	08/12/2020 05:23	18,48	4	73,91	CHI
20201230241	INDIARA	IY13391514	CEZARINA	07/12/2020 06:09	08/12/2020 10:14	07/12/2020 11:40	08/12/2020 10:14	22,57	12	270,79	CHI
20201231401	TRINDADE	TR11255673	TRINDADE	07/12/2020 06:10	07/12/2020 10:03	07/12/2020 06:10	07/12/2020 10:03	3,87	46	178,16	CHI
20201228927	TRINDADE	TR12237597LD	TRINDADE	07/12/2020 06:11	07/12/2020 07:16	07/12/2020 06:11	07/12/2020 07:16	1,07	1036	1110,53	CHI
20201230255	LUZIANIA	LZ12314632	VIANOPOLIS	07/12/2020 06:11	07/12/2020 12:20	07/12/2020 06:11	07/12/2020 12:20	6,14	2	12,29	CHI
20201230256	ITAPACI	IW12275237	ITAPACI	07/12/2020 06:11	07/12/2020 08:08	07/12/2020 06:11	07/12/2020 08:08	1,94	3	5,82	CHI
20201230266	PARAUNA	980015327	PARAUNA	07/12/2020 06:12	07/12/2020 21:33	07/12/2020 06:12	07/12/2020 21:33	15,34	1	15,34	CHI
20201230267	CORREGO DO OURO	CO12388371	SAO LUIZ DOS MONTES BELOS	07/12/2020 06:12	07/12/2020 21:53	07/12/2020 06:12	07/12/2020 21:53	15,68	101	1583,57	CHI
20201230267	FIRMINOPOLIS	CO12388371	SAO LUIZ DOS MONTES BELOS	07/12/2020 06:12	07/12/2020 21:53	07/12/2020 06:12	07/12/2020 21:53	15,68	20	313,58	CHI
20201230268	LUZIANIA	120181538	RIO VERMELHO	07/12/2020 06:12	07/12/2020 10:41	07/12/2020 06:12	07/12/2020 10:41	4,47	1	4,47	CHI
20201231625	ITAPIRAPUA	JR12087418	JUSSARA	07/12/2020 06:12	08/12/2020 07:38	07/12/2020 06:12	08/12/2020 07:38	25,42	1	25,42	CHI
20201231625	JUSSARA	JR12087418	JUSSARA	07/12/2020 06:12	08/12/2020 07:38	07/12/2020 06:12	08/12/2020 07:38	25,42	11	279,59	CHI
20201232558	COCALZINHO DE GOIAS	ZN12185681	COCALZINHO	07/12/2020 06:12	07/12/2020 11:39	07/12/2020 06:12	07/12/2020 11:39	5,45	7	38,15	CHI
20201232558	PIRENOPOLIS	ZN12185681	COCALZINHO	07/12/2020 06:12	07/12/2020 11:39	07/12/2020 06:12	07/12/2020 11:39	5,45	5	27,25	CHI
20201230460	CRISTALINA	KR10414222	CRISTALINA S1	07/12/2020 06:13	07/12/2020 16:36	07/12/2020 06:20	07/12/2020 09:48	3,45	10	34,52	CHI
20201230460	CRISTALINA	KR10414222	CRISTALINA S1	07/12/2020 06:13	07/12/2020 16:36	07/12/2020 06:20	07/12/2020 09:48	3,45	166	573,11	CHI
20201230460	CRISTALINA	KR12246115LD	CRISTALINA S1	07/12/2020 06:13	07/12/2020 16:36	07/12/2020 06:20	07/12/2020 11:55	5,57	20	111,37	CHI
20201230460	CRISTALINA	KR13376155	CRISTALINA S1	07/12/2020 06:13	07/12/2020 16:36	07/12/2020 06:20	07/12/2020 13:58	7,62	6	45,74	CHI
20201230460	CRISTALINA	KR12251692LD	CRISTALINA S1	07/12/2020 06:13	07/12/2020 16:36	07/12/2020 06:20	07/12/2020 15:33	9,22	64	589,81	CHI
20201230460	CRISTALINA	KR13251691	CRISTALINA S1	07/12/2020 06:13	07/12/2020 16:36	07/12/2020 06:20	07/12/2020 16:36	10,26	140	1436,52	CHI
20201230532	MORRINHOS	MR12119700RE	MORRINHOS	07/12/2020 06:13	07/12/2020 13:23	07/12/2020 06:13	07/12/2020 13:23	7,15	45	321,95	CHI
20201231052	MUTUNOPOLIS	MU12391981	MARA ROSA	07/12/2020 06:14	07/12/2020 14:45	07/12/2020 06:14	07/12/2020 14:45	8,51	5	42,56	CHI
20201231052	AMARALINA	MU12391981	MARA ROSA	07/12/2020 06:14	07/12/2020 14:45	07/12/2020 06:14	07/12/2020 14:45	8,51	5	42,56	CHI
20201231907	SAO MIGUEL DO PASSA QUATRO	SO12309601	CRISTIANOPOLIS	07/12/2020 06:14	07/12/2020 10:33	07/12/2020 06:14	07/12/2020 10:33	4,30	3	12,91	CHI
20201230284	MONTE ALEGRE DE GOIAS	MA11280078	SAO DOMINGOS	07/12/2020 06:15	07/12/2020 08:21	07/12/2020 06:15	07/12/2020 08:21	2,08	2	4,17	CHI
20201230854	MORRINHOS	MR12223453	GOIATUBA S1	07/12/2020 06:15	07/12/2020 11:47	07/12/2020 06:15	07/12/2020 11:47	5,53	36	198,99	CHI
20201230906	NOVO BRASIL	NB12087607	JUSSARA	07/12/2020 06:15	07/12/2020 11:50	07/12/2020 06:15	07/12/2020 11:50	5,57	10	55,69	CHI
20201230285	TRINDADE	17393000	GOYA S2	07/12/2020 06:16	07/12/2020 13:34	07/12/2020 06:16	07/12/2020 13:34	7,30	1	7,30	CHI
20201230292	APORE	AE12205145RE	ITAJA S2	07/12/2020 06:16	07/12/2020 07:31	07/12/2020 06:16	07/12/2020 07:31	1,23	33	40,72	CHI
20201230425	ORIZONA	OZ12114505	PIRES DO RIO S2	07/12/2020 06:16	07/12/2020 09:48	07/12/2020 06:16	07/12/2020 09:48	3,52	20	70,45	CHI
20201230879	INDIARA	JD12304492	PALMEIRAS	07/12/2020 06:16	07/12/2020 08:42	07/12/2020 06:16	07/12/2020 08:42	2,43	5	12,14	CHI
20201230879	JANDAIA	JD12304492	PALMEIRAS	07/12/2020 06:16	07/12/2020 08:42	07/12/2020 06:16	07/12/2020 08:42	2,43	20	48,56	CHI

20201230879	PALMEIRAS DE GOIAS	JD12304492	PALMEIRAS	07/12/2020 06:16	07/12/2020 08:42	07/12/2020 06:16	07/12/2020 08:42	2,43	38	92,26	CHI
20201230401	IPAMERI	IP12112268	PIRES DO RIO S2	07/12/2020 06:17	08/12/2020 12:14	07/12/2020 06:17	08/12/2020 09:00	26,72	11	293,87	CHI
20201230401	IPAMERI	IP12112268	PIRES DO RIO S2	07/12/2020 06:17	08/12/2020 12:14	07/12/2020 06:17	08/12/2020 10:02	27,74	8	221,95	CHI
20201230401	IPAMERI	IP12112268	PIRES DO RIO S2	07/12/2020 06:17	08/12/2020 12:14	07/12/2020 06:17	08/12/2020 12:14	29,94	1	29,94	CHI
20201230602	ITAPIRAPUA	IU12025065	MATRINCHA	07/12/2020 06:17	07/12/2020 16:40	07/12/2020 06:17	07/12/2020 16:40	10,38	15	155,74	CHI
20201230602	BRITANIA	IU12025065	MATRINCHA	07/12/2020 06:17	07/12/2020 16:40	07/12/2020 06:17	07/12/2020 16:40	10,38	6	62,29	CHI
20201231036	ITABERAI	IB12299550LD	ITABERAI S2	07/12/2020 06:17	07/12/2020 12:10	07/12/2020 06:17	07/12/2020 12:10	5,88	53	311,65	CHI
20201230305	CATALAO	CT21358262	CATALAO S1	07/12/2020 06:18	07/12/2020 10:42	07/12/2020 06:18	07/12/2020 10:42	4,40	1	4,40	CHI
20201232574	PORANGATU	PO12100815	NOVO PLANALTO	07/12/2020 06:18	07/12/2020 15:57	07/12/2020 06:18	07/12/2020 15:57	9,65	3	28,94	CHI
20201230314	RIO QUENTE	RQ21263104	RIO QUENTE	07/12/2020 06:19	07/12/2020 08:23	07/12/2020 06:19	07/12/2020 08:23	2,07	1	2,07	CHI
20201230317	VILA PROPICIO	10000893623	GOIANESIA S1	07/12/2020 06:19	07/12/2020 18:26	07/12/2020 06:19	07/12/2020 18:26	12,11	1	12,11	CHI
20201230612	PIRACANJUBA	MR12223456	MORRINHOS	07/12/2020 06:19	07/12/2020 08:46	07/12/2020 06:19	07/12/2020 08:46	2,45	7	17,13	CHI
20201230330	BELA VISTA DE GOIAS	BV10406882	BELA VISTA S1	07/12/2020 06:20	07/12/2020 15:45	07/12/2020 12:19	07/12/2020 15:45	3,44	38	130,78	CHI
20201230330	BELA VISTA DE GOIAS	BV12031908LD	BELA VISTA S1	07/12/2020 06:20	07/12/2020 15:45	07/12/2020 06:20	07/12/2020 15:45	9,42	59	555,71	CHI
20201230409	TRINDADE	TR11241344	TRINDADE	07/12/2020 06:20	07/12/2020 09:55	07/12/2020 06:20	07/12/2020 09:55	3,58	147	526,79	CHI
20201231063	CACU	CC12202629	CACHOEIRA ALTA	07/12/2020 06:20	07/12/2020 10:21	07/12/2020 06:20	07/12/2020 10:21	4,01	5	20,04	CHI
202012179381	CASTELANDIA	DM13160814	RIO DOS BOIS	07/12/2020 06:20	08/12/2020 15:38	07/12/2020 06:20	07/12/2020 20:48	14,46	1	14,46	CHI
202012179381	BOM JESUS DE GOIAS	DM13160814	RIO DOS BOIS	07/12/2020 06:20	08/12/2020 15:38	07/12/2020 06:20	07/12/2020 20:48	14,46	5	72,32	CHI
202012179381	GOIATUBA	DM13160814	RIO DOS BOIS	07/12/2020 06:20	08/12/2020 15:38	07/12/2020 06:20	07/12/2020 20:48	14,46	1	14,46	CHI
202012179381	MAURILANDIA	DM13160814	RIO DOS BOIS	07/12/2020 06:20	08/12/2020 15:38	07/12/2020 06:20	07/12/2020 20:48	14,46	4	57,86	CHI
202012179381	PORTEIRAO	DM13160814	RIO DOS BOIS	07/12/2020 06:20	08/12/2020 15:38	07/12/2020 06:20	07/12/2020 20:48	14,46	4	57,86	CHI
202012179381	PORTEIRAO	GT12030782	RIO DOS BOIS	07/12/2020 06:20	08/12/2020 15:38	08/12/2020 08:10	08/12/2020 08:29	0,32	3	0,95	CHI
202012179381	GOIATUBA	GT12030782	RIO DOS BOIS	07/12/2020 06:20	08/12/2020 15:38	08/12/2020 08:10	08/12/2020 08:29	0,32	1	0,32	CHI
202012179381	GOIATUBA	CL13230826	RIO DOS BOIS	07/12/2020 06:20	08/12/2020 15:38	07/12/2020 06:20	08/12/2020 10:39	28,32	19	538,01	CHI
202012179381	PORTEIRAO	CL13230826	RIO DOS BOIS	07/12/2020 06:20	08/12/2020 15:38	07/12/2020 06:20	08/12/2020 10:39	28,32	6	169,90	CHI
202012179381	PORTEIRAO	CL13230826	RIO DOS BOIS	07/12/2020 06:20	08/12/2020 15:38	07/12/2020 06:20	08/12/2020 10:39	28,32	2	56,63	CHI
202012179381	GOIATUBA	CL13230826	RIO DOS BOIS	07/12/2020 06:20	08/12/2020 15:38	07/12/2020 06:20	08/12/2020 10:39	28,32	402	11383,19	CHI
202012179381	GOIATUBA	BJ13160813	RIO DOS BOIS	07/12/2020 06:20	08/12/2020 15:38	07/12/2020 06:20	08/12/2020 14:40	32,34	3	97,03	CHI
202012179381	GOIATUBA	BJ13163263	RIO DOS BOIS	07/12/2020 06:20	08/12/2020 15:38	07/12/2020 06:20	08/12/2020 15:27	33,13	1	33,13	CHI
202012179381	PORTEIRAO	BJ13163264	RIO DOS BOIS	07/12/2020 06:20	08/12/2020 15:38	08/12/2020 14:55	08/12/2020 15:34	0,64	2	1,28	CHI
202012179381	GOIATUBA	BJ13163264	RIO DOS BOIS	07/12/2020 06:20	08/12/2020 15:38	08/12/2020 14:55	08/12/2020 15:34	0,64	402	258,28	CHI
202012179381	GOIATUBA	BJ13163267	RIO DOS BOIS	07/12/2020 06:20	08/12/2020 15:38	08/12/2020 14:55	08/12/2020 15:38	0,71	19	13,47	CHI
202012179381	PORTEIRAO	BJ13163267	RIO DOS BOIS	07/12/2020 06:20	08/12/2020 15:38	08/12/2020 14:55	08/12/2020 15:38	0,71	6	4,25	CHI
20201230590	NOVA ROMA	ND12302636	IACIARA S2	07/12/2020 06:21	10/12/2020 11:47	07/12/2020 06:21	07/12/2020 15:23	9,03	98	884,86	CHI
20201230590	SAO JOAO D ALIANCA	ND12302636	IACIARA S2	07/12/2020 06:21	10/12/2020 11:47	07/12/2020 06:21	07/12/2020 15:23	9,03	3	27,09	CHI
20201230590	NOVA ROMA	ND12302636	IACIARA S2	07/12/2020 06:21	10/12/2020 11:47	07/12/2020 06:21	07/12/2020 19:43	13,36	3	40,09	CHI
20201230590	SAO JOAO D ALIANCA	ND12302636	IACIARA S2	07/12/2020 06:21	10/12/2020 11:47	07/12/2020 06:21	07/12/2020 19:43	13,36	10	133,64	CHI
20201230590	ALTO PARAISO DE GOIAS	ND12302636	IACIARA S2	07/12/2020 06:21	10/12/2020 11:47	07/12/2020 06:21	07/12/2020 19:43	13,36	18	240,55	CHI
20201230590	ALTO PARAISO DE GOIAS	ND12170816LD	IACIARA S2	07/12/2020 06:21	10/12/2020 11:47	07/12/2020 19:55	09/12/2020 15:09	43,23	18	778,14	CHI
20201230590	SAO JOAO D ALIANCA	ND12170816LD	IACIARA S2	07/12/2020 06:21	10/12/2020 11:47	07/12/2020 19:55	09/12/2020 15:09	43,23	10	432,30	CHI
20201230590	NOVA ROMA	ND12170816LD	IACIARA S2	07/12/2020 06:21	10/12/2020 11:47	07/12/2020 19:55	09/12/2020 15:09	43,23	3	129,69	CHI
20201230590	ALTO PARAISO DE GOIAS	ND12302636	IACIARA S2	07/12/2020 06:21	10/12/2020 11:47	07/12/2020 06:21	10/12/2020 11:47	77,44	1	77,44	CHI
20201230741	CACU	CC12000096	CACHOEIRA ALTA	07/12/2020 06:21	07/12/2020 10:00	07/12/2020 06:21	07/12/2020 10:00	3,64	5	18,22	CHI
20201230343	ORIZONA	OZ121114545	PIRES DO RIO S2	07/12/2020 06:22	07/12/2020 09:47	07/12/2020 06:22	07/12/2020 09:47	3,41	27	92,06	CHI
20201230344	CACU	CC21084216	CACHOEIRA ALTA	07/12/2020 06:22	07/12/2020 12:41	07/12/2020 06:22	07/12/2020 12:41	6,30	1	6,30	CHI
20201230598	FLORES DE GOIAS	AQ12322731	IACIARA S2	07/12/2020 06:22	07/12/2020 08:37	07/12/2020 06:22	07/12/2020 08:37	2,25	10	22,48	CHI
20201230598	ALVORADA DO NORTE	AQ12322731	IACIARA S2	07/12/2020 06:22	07/12/2020 08:37	07/12/2020 06:22	07/12/2020 08:37	2,25	28	62,95	CHI
20201230358	HIDROLANDIA	HD12058903	ANHANGUERA	07/12/2020 06:24	07/12/2020 09:00	07/12/2020 06:24	07/12/2020 09:00	2,59	171	442,08	CHI
20201230397	TAQUARAL DE GOIAS	TQ12250793	ITABERAI S1	07/12/2020 06:24	07/12/2020 12:10	07/12/2020 06:24	07/12/2020 12:10	5,76	11	63,31	CHI
20201230363	NOVA IGUACU DE GOIAS	NH12202119	CAMPINORTE	07/12/2020 06:25	07/12/2020 08:52	07/12/2020 06:25	07/12/2020 08:52	2,43	8	19,47	CHI
20201231928	ITAPIRAPUA	NB12101199RE	JUSSARA	07/12/2020 06:25	07/12/2020 10:36	07/12/2020 06:25	07/12/2020 10:36	4,17	57	237,85	CHI

20201231928	NOVO BRASIL	NB12101199RE	JUSSARA	07/12/2020 06:25	07/12/2020 10:36	07/12/2020 06:25	07/12/2020 10:36	4,17	70	292,09	CHI
20201230366	PALMEIRAS DE GOIAS	PL12000219	PALMEIRAS	07/12/2020 06:26	07/12/2020 07:37	07/12/2020 06:26	07/12/2020 07:37	1,18	11	12,93	CHI
20201233160	CRIXAS	CX12283275	SERRA DO OURO	07/12/2020 06:27	07/12/2020 15:47	07/12/2020 06:27	07/12/2020 15:47	9,33	2	18,67	CHI
20201233695	PEROLANDIA	JT12390597	JATAI S1	07/12/2020 06:27	07/12/2020 22:36	07/12/2020 06:27	07/12/2020 22:36	16,14	6	96,81	CHI
20201233695	JATAI	JT12390597	JATAI S1	07/12/2020 06:27	07/12/2020 22:36	07/12/2020 06:27	07/12/2020 22:36	16,14	14	225,89	CHI
20201230647	PARAUNA	JD12008614	PALMEIRAS	07/12/2020 06:28	07/12/2020 10:21	07/12/2020 06:28	07/12/2020 10:21	3,88	6	23,28	CHI
20201230647	JANDAIA	JD12008614	PALMEIRAS	07/12/2020 06:28	07/12/2020 10:21	07/12/2020 06:28	07/12/2020 10:21	3,88	19	73,71	CHI
20201231864	ALOANDIA	AD12150204	GOIATUBA S1	07/12/2020 06:28	07/12/2020 10:58	07/12/2020 06:28	07/12/2020 10:58	4,50	21	94,47	CHI
20201230395	URUTAI	UT21109889	PIRES DO RIO S2	07/12/2020 06:29	07/12/2020 22:49	07/12/2020 06:29	07/12/2020 22:49	16,33	1	16,33	CHI
20201230398	PALMEIRAS DE GOIAS	PL12276902	PALMEIRAS	07/12/2020 06:29	07/12/2020 08:28	07/12/2020 06:29	07/12/2020 08:28	1,98	67	132,36	CHI
20201230404	JUSSARA	RN12009765	BRITANIA	07/12/2020 06:30	07/12/2020 22:56	07/12/2020 06:30	07/12/2020 22:56	16,43	1	16,43	CHI
20201230404	SANTA FE DE GOIAS	RN12009765	BRITANIA	07/12/2020 06:30	07/12/2020 22:56	07/12/2020 06:30	07/12/2020 22:56	16,43	22	361,50	CHI
20201230412	DIORAMA	DI21135463	IPORA	07/12/2020 06:30	07/12/2020 11:34	07/12/2020 06:30	07/12/2020 11:34	5,06	1	5,06	CHI
20201230413	MUNDO NOVO DE GOIAS	MH12189540	NOVA CRIXAS	07/12/2020 06:30	07/12/2020 14:11	07/12/2020 06:30	07/12/2020 14:11	7,67	5	38,36	CHI
20201233238	IPAMERI	IP12265542LD	PIRES DO RIO S2	07/12/2020 06:30	08/12/2020 13:12	07/12/2020 06:30	08/12/2020 00:41	18,19	15	272,80	CHI
20201233238	IPAMERI	IP12188743	PIRES DO RIO S2	07/12/2020 06:30	08/12/2020 13:12	07/12/2020 06:30	08/12/2020 13:12	30,71	4	122,86	CHI
20201230465	ITAPACI	IW12210233RE	ITAPACI	07/12/2020 06:31	07/12/2020 07:53	07/12/2020 06:31	07/12/2020 07:53	1,37	114	155,67	CHI
20201231234	FAINA	FC12299779	MATRINCHA	07/12/2020 06:31	07/12/2020 21:39	07/12/2020 06:31	07/12/2020 21:39	15,13	16	242,05	CHI
20201231234	MATRINCHA	FC12299779	MATRINCHA	07/12/2020 06:31	07/12/2020 21:39	07/12/2020 06:31	07/12/2020 21:39	15,13	37	559,74	CHI
20201230421	RIO VERDE	RV11350359	RIO VERDE S2	07/12/2020 06:32	07/12/2020 10:51	07/12/2020 06:32	07/12/2020 10:51	4,32	102	440,33	CHI
20201230422	MORRINHOS	MR12304043	MORRINHOS	07/12/2020 06:32	07/12/2020 15:49	07/12/2020 06:32	07/12/2020 15:49	9,28	3	27,84	CHI
20201230423	SANTO ANTONIO DO DESCOBERTO	AX12402045	ALEXANIA	07/12/2020 06:32	07/12/2020 11:27	07/12/2020 06:32	07/12/2020 11:27	4,91	1	4,91	CHI
20201230423	ALEXANIA	AX12402045	ALEXANIA	07/12/2020 06:32	07/12/2020 11:27	07/12/2020 06:32	07/12/2020 11:27	4,91	207	1016,95	CHI
20201230424	RIO QUENTE	RQ12122106	VILA CORUMBA	07/12/2020 06:32	07/12/2020 12:09	07/12/2020 06:32	07/12/2020 12:09	5,61	7	39,29	CHI
20201230424	AGUA LIMPA	RQ12122106	VILA CORUMBA	07/12/2020 06:32	07/12/2020 12:09	07/12/2020 06:32	07/12/2020 12:09	5,61	7	39,29	CHI
20201230426	NOVA ROMA	MA12405108	SAO DOMINGOS	07/12/2020 06:32	07/12/2020 11:50	07/12/2020 06:32	07/12/2020 11:50	5,29	57	301,77	CHI
20201230426	MONTE ALEGRE DE GOIAS	MA12405108	SAO DOMINGOS	07/12/2020 06:32	07/12/2020 11:50	07/12/2020 06:32	07/12/2020 11:50	5,29	531	2811,20	CHI
20201230426	CAVALCANTE	MA12405108	SAO DOMINGOS	07/12/2020 06:32	07/12/2020 11:50	07/12/2020 06:32	07/12/2020 11:50	5,29	245	1297,07	CHI
20201230437	CAMPO ALEGRE DE GOIAS	CM12077543RE	CAMPO ALEGRE DE GOIAS	07/12/2020 06:33	07/12/2020 10:54	07/12/2020 06:33	07/12/2020 10:54	4,34	16	69,41	CHI
20201230978	ITAPACI	IW12044978	ITAPACI	07/12/2020 06:33	07/12/2020 09:10	07/12/2020 06:33	07/12/2020 09:10	2,60	6	15,60	CHI
20201230443	BELA VISTA DE GOIAS	BV32097920	BELA VISTA S2	07/12/2020 06:34	07/12/2020 10:43	07/12/2020 06:34	07/12/2020 10:43	4,15	21	87,14	CHI
20201230447	RIO VERDE	RV21213260	MONTIVIDU T	07/12/2020 06:34	07/12/2020 09:03	07/12/2020 06:34	07/12/2020 09:03	2,47	1	2,47	CHI
20201233727	PIRACANJUBA	PJ12080893	PIRACANJUBA	07/12/2020 06:34	07/12/2020 17:00	07/12/2020 06:34	07/12/2020 17:00	10,43	5	52,16	CHI
20201230458	ITAPIRAPUA	IU12250537	JUSSARA	07/12/2020 06:36	07/12/2020 16:49	07/12/2020 06:36	07/12/2020 16:49	10,21	2	20,43	CHI
20201231072	PIRES DO RIO	PR12000079RE	PIRES DO RIO S1	07/12/2020 06:36	07/12/2020 10:45	07/12/2020 06:36	07/12/2020 10:45	4,15	17	70,52	CHI
20201230464	ITAUCU	PV12246847	CORUMBA	07/12/2020 06:37	07/12/2020 17:53	07/12/2020 06:37	07/12/2020 17:53	11,26	1	11,26	CHI
20201230464	PIRENOPOLIS	PV12246847	CORUMBA	07/12/2020 06:37	07/12/2020 17:53	07/12/2020 06:37	07/12/2020 17:53	11,26	77	867,08	CHI
20201230515	TRINDADE	TR11159251	GOYA S2	07/12/2020 06:38	07/12/2020 10:12	07/12/2020 06:38	07/12/2020 10:12	3,55	86	305,42	CHI
20201230736	ARAGOIANIA	GA32098705	GUAPO S2	07/12/2020 06:38	07/12/2020 10:33	07/12/2020 06:38	07/12/2020 10:33	3,91	2	7,82	CHI
20201230479	PORANGATU	PO21280968	PORANGATU	07/12/2020 06:39	07/12/2020 15:57	07/12/2020 06:39	07/12/2020 15:57	9,30	1	9,30	CHI
20201230482	BOM JESUS DE GOIAS	10000327083	BOM JESUS DE GOIAS	07/12/2020 06:39	08/12/2020 09:56	07/12/2020 06:39	08/12/2020 09:56	27,27	1	27,27	CHI
20201230712	GUARINOS	GF12181356	SANTA TEREZINHA	07/12/2020 06:39	07/12/2020 09:05	07/12/2020 06:39	07/12/2020 09:05	2,43	3	7,28	CHI
20201231509	TRINDADE	TR11000035	TRINDADE	07/12/2020 06:39	07/12/2020 10:27	07/12/2020 06:39	07/12/2020 10:27	3,79	115	435,79	CHI
20201230488	AGUA LIMPA	AL12097209	VILA CORUMBA	07/12/2020 06:40	07/12/2020 11:44	07/12/2020 06:40	07/12/2020 11:44	5,06	6	30,37	CHI
20201230491	PARANAIGUARA	PC21295753	CACHOEIRA ALTA	07/12/2020 06:40	07/12/2020 13:20	07/12/2020 06:40	07/12/2020 13:20	6,66	1	6,66	CHI
20201230495	GOIANDIRA	CY12079019	CATALAO S1	07/12/2020 06:41	07/12/2020 20:29	07/12/2020 06:41	07/12/2020 20:29	13,81	3	41,42	CHI
20201230495	CUMARI	CY12079019	CATALAO S1	07/12/2020 06:41	07/12/2020 20:29	07/12/2020 06:41	07/12/2020 20:29	13,81	5	69,04	CHI
20201230502	CAMPINACU	UC11269764	MARA ROSA	07/12/2020 06:41	07/12/2020 10:23	07/12/2020 06:41	07/12/2020 10:23	3,69	2	7,37	CHI
20201230505	RIO VERDE	RV12279701	RIO VERDE S1	07/12/2020 06:42	07/12/2020 10:10	07/12/2020 06:42	07/12/2020 10:10	3,47	1	3,47	CHI
20201230512	BELA VISTA DE GOIAS	BV21184796	BELA VISTA S1	07/12/2020 06:42	07/12/2020 12:47	07/12/2020 06:42	07/12/2020 12:47	6,08	3	18,23	CHI
20201230678	MUNDO NOVO DE GOIAS	MH12342078	NOVA CRIXAS	07/12/2020 06:42	07/12/2020 10:32	07/12/2020 06:42	07/12/2020 10:32	3,82	11	41,99	CHI

20201230714	JARAGUA	JA12200831	JARAGUA	07/12/2020 06:42	07/12/2020 13:50	07/12/2020 06:42	07/12/2020 13:50	7,13	14	99,84	CHI
20201230522	MIMOSO DE GOIAS	MJ12249518	PADRE BERNARDO	07/12/2020 06:43	07/12/2020 09:06	07/12/2020 06:43	07/12/2020 09:06	2,37	49	116,13	CHI
20201230711	BOM JESUS DE GOIAS	BJ12208036RE	BOM JESUS DE GOIAS	07/12/2020 06:43	07/12/2020 17:44	07/12/2020 06:43	07/12/2020 17:44	11,01	4	44,04	CHI
20201230711	GOIATUBA	BJ12208036RE	BOM JESUS DE GOIAS	07/12/2020 06:43	07/12/2020 17:44	07/12/2020 06:43	07/12/2020 17:44	11,01	1	11,01	CHI
20201232950	PIRENOPOLIS	PV12312036	CORUMBA	07/12/2020 06:43	07/12/2020 20:06	07/12/2020 06:43	07/12/2020 20:06	13,38	13	173,94	CHI
20201230530	APARECIDA DE GOIANIA	Z00005558	ANHANGUERA	07/12/2020 06:44	07/12/2020 08:22	07/12/2020 06:44	07/12/2020 08:22	1,63	1	1,63	CHI
20201230820	SANTA ISABEL	GE12000139	GOIANESIA S1	07/12/2020 06:44	07/12/2020 11:20	07/12/2020 06:44	07/12/2020 11:20	4,60	14	64,40	CHI
20201231914	PADRE BERNARDO	PB12261686	PADRE BERNARDO	07/12/2020 06:44	07/12/2020 11:16	07/12/2020 06:44	07/12/2020 11:16	4,52	8	36,19	CHI
20201230542	ANAPOLIS	AN12285315	ANAPOLIS UNIVERSITARIO S2	07/12/2020 06:45	07/12/2020 08:29	07/12/2020 06:45	07/12/2020 08:29	1,73	21	36,25	CHI
20201230544	NIQUELANDIA	NQ12197661	BARRO ALTO	07/12/2020 06:45	07/12/2020 08:22	07/12/2020 06:45	07/12/2020 08:22	1,61	12	19,29	CHI
20201230546	MAURILANDIA	ML12301060RE	RIO DOS BOIS	07/12/2020 06:45	07/12/2020 09:21	07/12/2020 06:45	07/12/2020 09:21	2,59	10	25,88	CHI
20201230546	TURVELANDIA	ML12301060RE	RIO DOS BOIS	07/12/2020 06:45	07/12/2020 09:21	07/12/2020 06:45	07/12/2020 09:21	2,59	17	44,00	CHI
20201230546	SANTA HELENA DE GOIAS	ML12301060RE	RIO DOS BOIS	07/12/2020 06:45	07/12/2020 09:21	07/12/2020 06:45	07/12/2020 09:21	2,59	51	132,00	CHI
20201230550	GOIAS	GS12162482	GOIAS	07/12/2020 06:45	07/12/2020 11:47	07/12/2020 06:45	07/12/2020 11:47	5,02	7	35,12	CHI
20201230551	MORRINHOS	MR31060427	MORRINHOS	07/12/2020 06:45	07/12/2020 18:10	07/12/2020 06:45	07/12/2020 18:10	11,41	1	11,41	CHI
20201230552	EDEIA	EA12257973	EDEIA	07/12/2020 06:45	07/12/2020 11:17	07/12/2020 06:45	07/12/2020 11:17	4,52	33	149,07	CHI
20201230552	ACREUNA	EA12257973	EDEIA	07/12/2020 06:45	07/12/2020 11:17	07/12/2020 06:45	07/12/2020 11:17	4,52	13	58,72	CHI
20201230552	INDIARA	EA12257973	EDEIA	07/12/2020 06:45	07/12/2020 11:17	07/12/2020 06:45	07/12/2020 11:17	4,52	7	31,62	CHI
20201232823	MARA ROSA	MQ12208421	MARA ROSA	07/12/2020 06:45	07/12/2020 13:56	07/12/2020 06:45	07/12/2020 13:56	7,17	14	100,36	CHI
20201230553	TRINDADE	10009781933	TRINDADE	07/12/2020 06:46	07/12/2020 13:31	07/12/2020 06:46	07/12/2020 13:31	6,75	1	6,75	CHI
20201230556	BURITI ALEGRE	BG12229309	ITUMBIARA VELHA S2	07/12/2020 06:46	07/12/2020 09:40	07/12/2020 06:46	07/12/2020 09:40	2,89	4	11,57	CHI
20201230557	ARUANA	AK11259667	ARUANA	07/12/2020 06:46	07/12/2020 10:56	07/12/2020 06:46	07/12/2020 10:56	4,16	25	103,93	CHI
20201230564	GOIANESIA	550011080	GOIANESIA S2	07/12/2020 06:47	07/12/2020 11:28	07/12/2020 06:47	07/12/2020 11:28	4,67	1	4,67	CHI
20201230565	AGUA FRIA DE GOIAS	PI12082205	SAO JOAO D ALIANCA	07/12/2020 06:47	07/12/2020 10:02	07/12/2020 06:47	07/12/2020 10:02	3,24	3	9,72	CHI
20201231054	TRINDADE	TR11055255	TRINDADE	07/12/2020 06:47	07/12/2020 10:03	07/12/2020 06:47	07/12/2020 10:03	3,26	116	378,10	CHI
20201230570	SILVANIA	SV21102293	VIANOPOLIS	07/12/2020 06:48	07/12/2020 09:50	07/12/2020 06:48	07/12/2020 09:50	3,03	1	3,03	CHI
20201230575	GOIANESIA	SJ21006522	GOIANESIA S1	07/12/2020 06:48	07/12/2020 10:30	07/12/2020 06:48	07/12/2020 10:30	3,69	1	3,69	CHI
20201230579	BURITI DE GOIAS	BS12099749	FIRMINOPOLIS S2	07/12/2020 06:48	07/12/2020 08:51	07/12/2020 06:48	07/12/2020 08:51	2,04	9	18,36	CHI
20201230580	LUZIANIA	LZ11351337	RIO VERMELHO	07/12/2020 06:48	07/12/2020 14:40	07/12/2020 06:48	07/12/2020 14:40	7,85	19	149,23	CHI
20201234749	JAUPACI	JP12349721	IPORA	07/12/2020 06:48	08/12/2020 16:00	07/12/2020 06:48	08/12/2020 16:00	33,21	7	232,47	CHI
20201230584	ARENOPOLIS	AY12040880	ARENOPOLIS	07/12/2020 06:49	07/12/2020 13:05	07/12/2020 06:49	07/12/2020 13:05	6,26	2	12,53	CHI
20201230587	CAMPO ALEGRE DE GOIAS	CM21294385	CAMPO ALEGRE DE GOIAS	07/12/2020 06:49	07/12/2020 09:30	07/12/2020 06:49	07/12/2020 09:30	2,68	3	8,03	CHI
20201232603	MONTIVIDIU DO NORTE	MX12187844	PORANGATU	07/12/2020 06:49	08/12/2020 00:23	07/12/2020 06:49	08/12/2020 00:23	17,56	45	790,24	CHI
20201230592	ITABERAI	MD12020754	ITABERAI S2	07/12/2020 06:50	07/12/2020 10:01	07/12/2020 06:50	07/12/2020 10:01	3,18	27	85,86	CHI
20201230592	MOSSAMEDES	MD12020754	ITABERAI S2	07/12/2020 06:50	07/12/2020 10:01	07/12/2020 06:50	07/12/2020 10:01	3,18	2	6,36	CHI
20201230595	CRISTALINA	KR12389576	CRISTALINA S2	07/12/2020 06:50	07/12/2020 14:11	07/12/2020 06:50	07/12/2020 14:11	7,34	28	205,55	CHI
20201233056	ISRAELANDIA	IS12184337	IPORA	07/12/2020 06:50	07/12/2020 15:58	07/12/2020 06:50	07/12/2020 15:58	9,13	10	91,27	CHI
20201230597	SAO JOAO D ALIANCA	JL12218486	SAO JOAO D ALIANCA	07/12/2020 06:51	07/12/2020 10:05	07/12/2020 06:51	07/12/2020 10:05	3,23	2	6,47	CHI
20201230600	TRINDADE	16556150	GOYA S2	07/12/2020 06:51	07/12/2020 08:47	07/12/2020 06:51	07/12/2020 08:47	1,92	1	1,92	CHI
20201230606	VIANOPOLIS	OZ12036983	PIRES DO RIO S2	07/12/2020 06:52	07/12/2020 12:56	07/12/2020 06:52	07/12/2020 12:56	6,05	11	66,56	CHI
20201230606	ORIZONA	OZ12036983	PIRES DO RIO S2	07/12/2020 06:52	07/12/2020 12:56	07/12/2020 06:52	07/12/2020 12:56	6,05	1	6,05	CHI
20201232816	PONTALINA	PK12182928	PONTALINA	07/12/2020 06:52	08/12/2020 07:41	07/12/2020 06:52	08/12/2020 07:41	24,81	15	372,15	CHI
20201230614	BELA VISTA DE GOIAS	BV21070529	BELA VISTA S2	07/12/2020 06:53	07/12/2020 11:56	07/12/2020 06:53	07/12/2020 11:56	5,03	2	10,07	CHI
20201230615	TRINDADE	TR11180208	TRINDADE	07/12/2020 06:53	07/12/2020 10:30	07/12/2020 06:53	07/12/2020 10:30	3,61	91	328,66	CHI
20201231006	PROFESSOR JAMIL SAFADY	PJ12123653	ROCHEDO	07/12/2020 06:53	07/12/2020 11:14	07/12/2020 06:53	07/12/2020 11:14	4,35	13	56,54	CHI
20201230616	AGUA FRIA DE GOIAS	TL21211514	SAO JOAO D ALIANCA	07/12/2020 06:54	07/12/2020 10:40	07/12/2020 06:54	07/12/2020 10:40	3,77	1	3,77	CHI
20201230620	APARECIDA DE GOIANIA	13867854	INDEPENDENCIA S1	07/12/2020 06:54	07/12/2020 23:47	07/12/2020 06:54	07/12/2020 23:47	16,88	1	16,88	CHI
20201230623	GOUVELANDIA	QI12000140	QUIRINOPOLIS	07/12/2020 06:54	07/12/2020 15:19	07/12/2020 10:07	07/12/2020 15:19	5,19	12	62,30	CHI
20201230627	JATAI	JT12182074	JATAI S1	07/12/2020 06:55	07/12/2020 08:38	07/12/2020 06:55	07/12/2020 08:38	1,71	7	11,94	CHI
20201231270	AMARALINA	LC12270741	SAO MIGUEL DO ARAGUAIA	07/12/2020 06:55	08/12/2020 02:45	07/12/2020 06:55	08/12/2020 02:45	19,83	10	198,27	CHI
20201230568	JAUPACI	JP10396034	IPORA	07/12/2020 06:56	07/12/2020 18:16	07/12/2020 06:56	07/12/2020 18:16	11,33	80	906,22	CHI

20201230568	FAZENDA NOVA	JP10396034	IPORA	07/12/2020 06:56	07/12/2020 18:16	07/12/2020 06:56	07/12/2020 18:16	11,33	19	215,23	CHI
20201230568	DIORAMA	JP10396034	IPORA	07/12/2020 06:56	07/12/2020 18:16	07/12/2020 06:56	07/12/2020 18:16	11,33	12	135,93	CHI
20201230630	SILVANIA	SV21385048	VIANOPOLIS	07/12/2020 06:56	07/12/2020 09:07	07/12/2020 06:56	07/12/2020 09:07	2,18	1	2,18	CHI
20201230632	SAO DOMINGOS	SD12192246	SAO DOMINGOS	07/12/2020 06:56	07/12/2020 10:09	07/12/2020 06:56	07/12/2020 10:09	3,21	12	38,52	CHI
20201230632	GUARANI DE GOIAS	SD12192246	SAO DOMINGOS	07/12/2020 06:56	07/12/2020 10:09	07/12/2020 06:56	07/12/2020 10:09	3,21	3	9,63	CHI
20201230648	SAO JOAO D ALIANCA	JL12218396	SAO JOAO D ALIANCA	07/12/2020 06:57	07/12/2020 09:30	07/12/2020 06:57	07/12/2020 09:30	2,54	6	15,24	CHI
20201230649	JATAI	JT12187749	JATAI S1	07/12/2020 06:57	07/12/2020 13:00	07/12/2020 06:57	07/12/2020 13:00	6,04	1	6,04	CHI
20201230650	ANAPOLIS	AN12135843	ANAPOLIS UNIVERSITARIO S2	07/12/2020 06:57	07/12/2020 09:55	07/12/2020 06:57	07/12/2020 09:55	2,95	647	1910,09	CHI
20201233350	NEROPOLIS	NR12010422	NEROPOLIS S2	07/12/2020 06:57	08/12/2020 02:53	07/12/2020 06:57	08/12/2020 02:53	19,94	4	79,74	CHI
20201230653	CAIAPONIA	CP12158149	IPORA	07/12/2020 06:58	08/12/2020 08:58	07/12/2020 06:58	08/12/2020 08:58	26,00	5	129,99	CHI
20201230655	QUIRINOPOLIS	QI21163423	QUIRINOPOLIS	07/12/2020 06:58	07/12/2020 12:15	07/12/2020 06:58	07/12/2020 12:15	5,28	1	5,28	CHI
20201230660	IPAMERI	IP21360087	IPAMERI	07/12/2020 06:58	07/12/2020 18:33	07/12/2020 06:58	07/12/2020 18:33	11,57	1	11,57	CHI
20201231920	BELA VISTA DE GOIAS	BV12281895	BELA VISTA S1	07/12/2020 06:58	07/12/2020 11:44	07/12/2020 06:58	07/12/2020 11:44	4,75	19	90,34	CHI
20201230666	URUTAI	UT12115680	PIRES DO RIO S2	07/12/2020 06:59	07/12/2020 09:09	07/12/2020 06:59	07/12/2020 09:09	2,16	33	71,14	CHI
20201230696	MATRINCHA	MP12378879	MATRINCHA	07/12/2020 06:59	08/12/2020 02:55	07/12/2020 06:59	08/12/2020 02:55	19,92	4	79,67	CHI
20201230693	VARJAO	VJ32066169	GUAPU S2	07/12/2020 07:00	07/12/2020 10:41	07/12/2020 07:00	07/12/2020 10:41	3,67	16	58,76	CHI
20201231242	CRISTALINA	KR21165523	CRISTALINA S2	07/12/2020 07:00	07/12/2020 14:48	07/12/2020 07:00	07/12/2020 14:48	7,80	1	7,80	CHI
20201232891	ALOANDIA	AD12293139	GOIATUBA S1	07/12/2020 07:01	07/12/2020 15:19	07/12/2020 07:01	07/12/2020 15:19	8,29	7	58,06	CHI
20201232891	PONTALINA	AD12293139	GOIATUBA S1	07/12/2020 07:01	07/12/2020 15:19	07/12/2020 07:01	07/12/2020 15:19	8,29	1	8,29	CHI
20201230692	NOVA ROMA	ND12327209	IACIARA S2	07/12/2020 07:02	07/12/2020 13:25	07/12/2020 07:02	07/12/2020 13:25	6,37	59	376,03	CHI
20201231947	PIRACANJUBA	PJ12026346	BELA VISTA S1	07/12/2020 07:02	07/12/2020 12:34	07/12/2020 07:02	07/12/2020 12:34	5,53	3	16,59	CHI
20201231947	BELA VISTA DE GOIAS	PJ12026346	BELA VISTA S1	07/12/2020 07:02	07/12/2020 12:34	07/12/2020 07:02	07/12/2020 12:34	5,53	3	16,59	CHI
20201233511	MAIRIPOTABA	MI12078688	PONTALINA	07/12/2020 07:02	08/12/2020 07:05	07/12/2020 07:02	08/12/2020 07:05	24,04	9	216,32	CHI
20201230697	PORANGATU	840122937	PORANGATU	07/12/2020 07:03	07/12/2020 12:35	07/12/2020 07:03	07/12/2020 12:35	5,53	1	5,53	CHI
20201230702	ITUMBIAIRA	BI12000194	CACHOEIRA DOURADA	07/12/2020 07:03	07/12/2020 19:44	07/12/2020 07:03	07/12/2020 19:44	12,67	3	38,01	CHI
20201231910	PADRE BERNARDO	PB12248653	PADRE BERNARDO	07/12/2020 07:03	07/12/2020 11:49	07/12/2020 07:03	07/12/2020 11:49	4,76	23	109,49	CHI
20201230703	SANTA FE DE GOIAS	RN12206969	JUSSARA	07/12/2020 07:04	07/12/2020 16:50	07/12/2020 07:04	07/12/2020 16:50	9,77	2	19,53	CHI
20201230706	PIRACANJUBA	PJ12263230	CALDAS NOVAS S1	07/12/2020 07:04	07/12/2020 21:23	07/12/2020 07:04	07/12/2020 21:23	14,32	17	243,37	CHI
20201230706	CALDAS NOVAS	PJ12263230	CALDAS NOVAS S1	07/12/2020 07:04	07/12/2020 21:23	07/12/2020 07:04	07/12/2020 21:23	14,32	1	14,32	CHI
20201230719	GOIATUBA	GT12008236	BOM JESUS DE GOIAS	07/12/2020 07:05	07/12/2020 10:02	07/12/2020 07:05	07/12/2020 10:02	2,93	11	32,28	CHI
20201230720	SAO DOMINGOS	SD12317864	SAO DOMINGOS	07/12/2020 07:06	07/12/2020 12:48	07/12/2020 07:06	07/12/2020 12:48	5,70	34	193,76	CHI
20201230723	IACIARA	ND21381621	IACIARA S2	07/12/2020 07:06	07/12/2020 09:32	07/12/2020 07:06	07/12/2020 09:32	2,43	1	2,43	CHI
20201230732	CALDAS NOVAS	CN11331866	CALDAS NOVAS S1	07/12/2020 07:07	07/12/2020 09:43	07/12/2020 07:07	07/12/2020 09:43	2,60	2	5,20	CHI
20201232366	PORANGATU	PO12321960	PORANGATU	07/12/2020 07:07	07/12/2020 11:23	07/12/2020 07:07	07/12/2020 11:23	4,26	2	8,51	CHI
20201231668	EDEIA	EA12007673	RIO DOS BOIS	07/12/2020 07:08	07/12/2020 14:16	07/12/2020 07:08	07/12/2020 14:16	7,14	2	14,29	CHI
20201231852	MOZARLANDIA	MZ12230681	RUBIATABA	07/12/2020 07:08	07/12/2020 17:22	07/12/2020 07:08	07/12/2020 17:22	10,23	3	30,69	CHI
20201230753	BARRO ALTO	BA12000043	BARRO ALTO	07/12/2020 07:09	07/12/2020 15:12	07/12/2020 07:09	07/12/2020 15:12	8,04	1	8,04	CHI
20201232224	MONTIVIDIU	MV12160710	MONTIVIDIU T	07/12/2020 07:09	07/12/2020 18:55	07/12/2020 07:09	07/12/2020 18:55	11,76	19	223,36	CHI
20201230755	RIO VERDE	RV16404241	RIO VERDE S1	07/12/2020 07:10	07/12/2020 14:13	07/12/2020 08:18	07/12/2020 08:25	0,11	816	91,12	CHI
20201230755	RIO VERDE	RV16404241	RIO VERDE S1	07/12/2020 07:10	07/12/2020 14:13	07/12/2020 08:18	07/12/2020 08:25	0,11	8558	955,64	CHI
20201230755	SANTA HELENA DE GOIAS	O1600254	RIO VERDE S1	07/12/2020 07:10	07/12/2020 14:13	07/12/2020 07:54	07/12/2020 08:37	0,72	57	40,80	CHI
20201230755	RIO VERDE	O1600254	RIO VERDE S1	07/12/2020 07:10	07/12/2020 14:13	07/12/2020 07:54	07/12/2020 08:37	0,72	5021	3594,20	CHI
20201230755	RIO VERDE	RV13380665	RIO VERDE S1	07/12/2020 07:10	07/12/2020 14:13	07/12/2020 07:10	07/12/2020 09:50	2,67	312	834,51	CHI
20201230755	RIO VERDE	RV120000311D	RIO VERDE S1	07/12/2020 07:10	07/12/2020 14:13	07/12/2020 07:10	07/12/2020 13:35	6,42	509	3268,77	CHI
20201230755	RIO VERDE	RV120000311D	RIO VERDE S1	07/12/2020 07:10	07/12/2020 14:13	07/12/2020 07:54	07/12/2020 13:35	5,68	102	579,13	CHI
20201230755	RIO VERDE	RV120306911D	RIO VERDE S1	07/12/2020 07:10	07/12/2020 14:13	07/12/2020 13:26	07/12/2020 14:13	0,77	312	241,54	CHI
20201230756	APARECIDA DE GOIANIA	10031179183	INDEPENDENCIA S2	07/12/2020 07:10	07/12/2020 08:55	07/12/2020 07:10	07/12/2020 08:55	1,74	1	1,74	CHI
20201230758	NOVA CRIXAS	NA12151235	NOVA CRIXAS	07/12/2020 07:10	07/12/2020 10:43	07/12/2020 07:10	07/12/2020 10:43	3,54	1	3,54	CHI
20201230760	NOVA CRIXAS	NA12096364	NOVA CRIXAS	07/12/2020 07:10	08/12/2020 02:55	07/12/2020 07:10	08/12/2020 02:55	19,74	4	78,95	CHI
20201230771	TRINDADE	40308546	TRINDADE	07/12/2020 07:11	07/12/2020 11:40	07/12/2020 07:11	07/12/2020 11:40	4,47	1	4,47	CHI
20201232645	RIO QUENTE	RQ12092147	RIO QUENTE	07/12/2020 07:11	07/12/2020 12:38	07/12/2020 07:11	07/12/2020 12:38	5,43	1	5,43	CHI

20201230775	ANAPOLIS	AN12000963	JUNDIAI S2	07/12/2020 07:12	07/12/2020 09:12	07/12/2020 07:12	07/12/2020 09:12	1,99	1	1,99	CHI
20201230781	CAMPINORTE	MQ21244404	MARA ROSA	07/12/2020 07:12	07/12/2020 16:00	07/12/2020 07:12	07/12/2020 15:28	8,27	1	8,27	CHI
20201230781	CAMPINORTE	MQ12182481	MARA ROSA	07/12/2020 07:12	07/12/2020 16:00	07/12/2020 13:31	07/12/2020 16:00	2,48	1	2,48	CHI
20201230781	MARA ROSA	MQ12182481	MARA ROSA	07/12/2020 07:12	07/12/2020 16:00	07/12/2020 13:31	07/12/2020 16:00	2,48	1	2,48	CHI
20201230784	SAO FRANCISCO DE GOIAS	SF21211891	SAO FRANCISCO DE GOIAS	07/12/2020 07:12	07/12/2020 12:03	07/12/2020 07:12	07/12/2020 12:03	4,83	1	4,83	CHI
20201230791	PALMEIRAS DE GOIAS	PL12357854	PALMEIRAS	07/12/2020 07:13	07/12/2020 09:19	07/12/2020 07:13	07/12/2020 09:19	2,09	2	4,18	CHI
20201231325	PADRE BERNARDO	PB12163212	PADRE BERNARDO	07/12/2020 07:13	07/12/2020 10:26	07/12/2020 07:13	07/12/2020 10:26	3,20	20	64,02	CHI
20201232479	MINEIROS	MY12348107	PARQUE DAS EMAS	07/12/2020 07:13	07/12/2020 20:23	07/12/2020 07:13	07/12/2020 20:23	13,17	11	144,87	CHI
20201230794	APARECIDA DE GOIANIA	AP11154793	REAL S1	07/12/2020 07:14	07/12/2020 11:21	07/12/2020 07:14	07/12/2020 11:21	4,12	140	576,53	CHI
20201230800	JUSSARA	JR12210571	JUSSARA	07/12/2020 07:14	08/12/2020 15:41	07/12/2020 07:14	08/12/2020 15:41	32,45	6	194,67	CHI
20201231298	AGUA FRIA DE GOIAS	JL12270094	SAO JOAO D ALIANCA	07/12/2020 07:14	07/12/2020 10:22	07/12/2020 07:14	07/12/2020 10:22	3,12	1	3,12	CHI
20201231298	SAO JOAO D ALIANCA	JL12270094	SAO JOAO D ALIANCA	07/12/2020 07:14	07/12/2020 10:22	07/12/2020 07:14	07/12/2020 10:22	3,12	8	24,97	CHI
20201230804	ITABERAI	IB12299538	ITABERAI S1	07/12/2020 07:15	07/12/2020 10:16	07/12/2020 07:15	07/12/2020 10:16	3,01	3	9,04	CHI
20201230808	SAO FRANCISCO DE GOIAS	SF21381360	SAO FRANCISCO DE GOIAS	07/12/2020 07:15	07/12/2020 11:21	07/12/2020 07:15	07/12/2020 11:21	4,10	1	4,10	CHI
20201230817	PANAMA	GT12249848	GOIATUBA S1	07/12/2020 07:16	07/12/2020 13:33	07/12/2020 07:16	07/12/2020 13:33	6,28	9	56,52	CHI
20201230822	PORANGATU	PO12230543	PORANGATU	07/12/2020 07:16	07/12/2020 11:03	07/12/2020 07:16	07/12/2020 11:03	3,77	1	3,77	CHI
20201230824	MONTIVIDIU	MV12214243	MONTIVIDIU T	07/12/2020 07:16	07/12/2020 20:17	07/12/2020 07:16	07/12/2020 20:17	13,00	2	26,00	CHI
20201231137	CRISTALINA	KR12376280	PAMPLONA	07/12/2020 07:16	07/12/2020 14:08	07/12/2020 07:16	07/12/2020 14:08	6,86	61	418,68	CHI
20201232296	IPAMERI	IP12247907	CRISTALINA S2	07/12/2020 07:16	07/12/2020 16:10	07/12/2020 07:16	07/12/2020 16:10	8,90	24	213,53	CHI
20201230827	GOIANIA	14251164	GOYA S1	07/12/2020 07:17	07/12/2020 08:38	07/12/2020 07:17	07/12/2020 08:38	1,35	1	1,35	CHI
20201231770	FORMOSA	FA11375560	ITUIQUIRA	07/12/2020 07:17	07/12/2020 11:18	07/12/2020 07:17	07/12/2020 11:18	4,03	21	84,64	CHI
20201230877	SIMOLANDIA	SA12168083	IACIARA S2	07/12/2020 07:18	07/12/2020 13:46	07/12/2020 07:18	07/12/2020 13:46	6,47	40	258,68	CHI
20201232637	CORUMBAIBA	CI12000543	VILA CORUMBA	07/12/2020 07:18	08/12/2020 08:24	07/12/2020 07:18	08/12/2020 08:24	25,08	9	225,76	CHI
20201230844	CUMARI	CY12034702	CATALAO S1	07/12/2020 07:19	07/12/2020 20:29	07/12/2020 07:19	07/12/2020 20:29	13,17	1	13,17	CHI
20201232218	MORRINHOS	MR12000150	MORRINHOS	07/12/2020 07:19	07/12/2020 11:21	07/12/2020 07:19	07/12/2020 11:21	4,03	28	112,75	CHI
20201230853	LUZIANIA	L20197625	RIO VERMELHO	07/12/2020 07:20	07/12/2020 11:47	07/12/2020 07:20	07/12/2020 11:47	4,45	1	4,45	CHI
20201230858	ABADIANIA	AA21141457	ANAPOLIS UNIVERSITARIO S1	07/12/2020 07:20	07/12/2020 17:34	07/12/2020 07:20	07/12/2020 17:34	10,22	1	10,22	CHI
20201230882	FLORES DE GOIAS	FB10401475	FLORES DE GOIAS	07/12/2020 07:20	07/12/2020 19:22	07/12/2020 07:20	07/12/2020 13:12	5,87	8	46,93	CHI
20201230882	FLORES DE GOIAS	FB13344302	FLORES DE GOIAS	07/12/2020 07:20	07/12/2020 19:22	07/12/2020 07:20	07/12/2020 15:14	7,89	17	134,12	CHI
20201230882	ALVORADA DO NORTE	FB13344302	FLORES DE GOIAS	07/12/2020 07:20	07/12/2020 19:22	07/12/2020 07:20	07/12/2020 15:14	7,89	18	142,01	CHI
20201230882	IACIARA	FB12068785LD	FLORES DE GOIAS	07/12/2020 07:20	07/12/2020 19:22	07/12/2020 07:20	07/12/2020 19:22	12,03	20	240,53	CHI
20201230882	ALVORADA DO NORTE	FB12068785LD	FLORES DE GOIAS	07/12/2020 07:20	07/12/2020 19:22	07/12/2020 07:20	07/12/2020 19:22	12,03	36	432,96	CHI
20201230882	POSSE	FB12068785LD	FLORES DE GOIAS	07/12/2020 07:20	07/12/2020 19:22	07/12/2020 07:20	07/12/2020 19:22	12,03	2	24,05	CHI
20201231654	PARAUNA	PU12301132	ACREUNA	07/12/2020 07:20	08/12/2020 07:29	07/12/2020 07:20	08/12/2020 07:29	24,14	2	48,27	CHI
20201231726	FAZENDA NOVA	FN11249648	JUSSARA	07/12/2020 07:20	07/12/2020 16:45	07/12/2020 07:20	07/12/2020 16:45	9,42	50	471,01	CHI
20201230866	JATAI	JT11055280	JATAI S3	07/12/2020 07:21	07/12/2020 14:13	07/12/2020 07:21	07/12/2020 14:13	6,86	139	953,50	CHI
20201230873	GUAPO	GA21008762	GUAPO S2	07/12/2020 07:22	07/12/2020 11:06	07/12/2020 07:22	07/12/2020 11:06	3,73	1	3,73	CHI
20201230874	PALMEIRAS DE GOIAS	PL21361924	PALMEIRAS	07/12/2020 07:22	07/12/2020 08:18	07/12/2020 07:22	07/12/2020 08:18	0,93	1	0,93	CHI
20201232589	PONTALINA	PK11223577	PONTALINA	07/12/2020 07:22	07/12/2020 15:05	07/12/2020 07:22	07/12/2020 15:05	7,72	110	848,80	CHI
20201231170	RIO VERDE	CP12191771	MONTIVIDIU T	07/12/2020 07:23	07/12/2020 13:04	07/12/2020 07:23	07/12/2020 13:04	5,68	3	17,05	CHI
20201231170	CAIAPONIA	CP12191771	MONTIVIDIU T	07/12/2020 07:23	07/12/2020 13:04	07/12/2020 07:23	07/12/2020 13:04	5,68	11	62,52	CHI
20201231170	JATAI	CP12191771	MONTIVIDIU T	07/12/2020 07:23	07/12/2020 13:04	07/12/2020 07:23	07/12/2020 13:04	5,68	7	39,79	CHI
20201230890	ITARUMA	IM12343771	CACHOEIRA ALTA	07/12/2020 07:24	07/12/2020 10:51	07/12/2020 07:24	07/12/2020 10:51	3,44	1	3,44	CHI
20201230892	CORUMBAIBA	CI12180475	VILA CORUMBA	07/12/2020 07:24	07/12/2020 15:52	07/12/2020 07:24	07/12/2020 15:52	8,46	3	25,37	CHI
20201231079	NIQUELANDIA	NQ12253279	BARRO ALTO	07/12/2020 07:24	07/12/2020 10:30	07/12/2020 07:24	07/12/2020 10:30	3,09	7	21,61	CHI
20201230902	MONTIVIDIU	MV12249172	MONTIVIDIU T	07/12/2020 07:25	07/12/2020 14:58	07/12/2020 07:25	07/12/2020 14:58	7,54	4	30,17	CHI
20201230903	JATAI	290295490	JATAI S2	07/12/2020 07:25	07/12/2020 14:23	07/12/2020 07:25	07/12/2020 14:23	6,96	1	6,96	CHI
20201230907	NIQUELANDIA	NQ21342376	SAO JOAO D ALIANCA	07/12/2020 07:25	07/12/2020 20:52	07/12/2020 07:25	07/12/2020 20:52	13,44	1	13,44	CHI
20201231536	ITAPIRAPUA	IU12206883	MATRINCHA	07/12/2020 07:25	08/12/2020 07:24	07/12/2020 07:25	08/12/2020 07:24	23,98	13	311,77	CHI
20201231666	SERRANOPOLIS	JT12219337RE	JATAI S1	07/12/2020 07:25	07/12/2020 13:36	07/12/2020 07:25	07/12/2020 13:36	6,17	15	92,57	CHI
20201230911	SILVANIA	SV11000017	VIANOPOLIS	07/12/2020 07:26	07/12/2020 09:27	07/12/2020 07:26	07/12/2020 09:27	2,01	194	390,32	CHI

20201230913	CORUMBAIBA	CI21307784	VILA CORUMBA	07/12/2020 07:26	07/12/2020 17:14	07/12/2020 07:26	07/12/2020 17:14	9,79	1	9,79	CHI
20201230915	ALVORADA DO NORTE	1510015738	IACIARA S2	07/12/2020 07:26	07/12/2020 21:10	07/12/2020 07:26	07/12/2020 21:10	13,72	1	13,72	CHI
20201230933	NAZARIO	PL12000123	PALMEIRAS	07/12/2020 07:28	07/12/2020 17:39	07/12/2020 07:28	07/12/2020 17:39	10,18	2	20,35	CHI
20201230936	CEZARINA	CZ12035074	CEZARINA	07/12/2020 07:29	07/12/2020 10:53	07/12/2020 07:29	07/12/2020 10:53	3,40	368	1249,87	CHI
20201230939	CRISTALINA	KR12090782	PAMPLONA	07/12/2020 07:29	07/12/2020 13:09	07/12/2020 07:29	07/12/2020 13:09	5,66	6	33,95	CHI
20201230940	BOM JESUS DE GOIAS	BJ12007756	BOM JESUS DE GOIAS	07/12/2020 07:29	07/12/2020 17:50	07/12/2020 07:29	07/12/2020 17:50	10,34	2	20,68	CHI
20201230941	CATALAO	1990314421	CATALAO S2	07/12/2020 07:29	07/12/2020 11:56	07/12/2020 07:29	07/12/2020 11:56	4,44	1	4,44	CHI
20201230943	FORMOSA	FA11100256	ITUIQUIRA	07/12/2020 07:29	08/12/2020 12:26	07/12/2020 07:29	08/12/2020 12:26	28,93	15	434,00	CHI
20201230945	ITARUMA	IJ12107422LD	ITAJA S2	07/12/2020 07:30	07/12/2020 08:35	07/12/2020 07:30	07/12/2020 08:35	1,08	42	45,34	CHI
20201230949	RIO VERDE	RV21365485	MONTIVIDIU T	07/12/2020 07:30	07/12/2020 13:43	07/12/2020 07:30	07/12/2020 13:43	6,21	1	6,21	CHI
20201230952	JARAGUA	JA21000096	JARAGUA	07/12/2020 07:30	07/12/2020 12:16	07/12/2020 07:30	07/12/2020 12:16	4,76	1	4,76	CHI
20201232411	AGUA FRIA DE GOIAS	TL12211505	SAO JOAO D ALIANCA	07/12/2020 07:30	07/12/2020 17:56	07/12/2020 07:30	07/12/2020 17:56	10,42	4	41,68	CHI
20201230958	SANTA BARBARA DE GOIAS	1030009202	TRINDADE	07/12/2020 07:31	07/12/2020 11:17	07/12/2020 07:31	07/12/2020 11:17	3,76	1	3,76	CHI
20201230962	TROMBAS	TB21146552	PORANGATU	07/12/2020 07:31	08/12/2020 07:12	07/12/2020 07:31	08/12/2020 07:12	23,67	1	23,67	CHI
20201230963	APARECIDA DE GOIANIA	14509751	INDEPENDENCIA S2	07/12/2020 07:31	07/12/2020 09:26	07/12/2020 07:31	07/12/2020 09:26	1,91	1	1,91	CHI
20201231809	GOUVELANDIA	GB12000204	QUIRINOPOLIS	07/12/2020 07:31	07/12/2020 10:22	07/12/2020 07:31	07/12/2020 10:22	2,84	3	8,52	CHI
20201230966	SERRANOPOLIS	SX21156828	JATAI S1	07/12/2020 07:32	08/12/2020 08:37	07/12/2020 07:32	08/12/2020 08:37	25,08	1	25,08	CHI
20201231044	ITUMBIARA	CD12000221	CACHOEIRA DOURADA	07/12/2020 07:32	07/12/2020 21:55	07/12/2020 07:32	07/12/2020 21:55	14,37	6	86,20	CHI
20201230977	TRINDADE	40167707	TRINDADE	07/12/2020 07:33	07/12/2020 12:19	07/12/2020 07:33	07/12/2020 12:19	4,75	1	4,75	CHI
20201230980	RIO VERDE	RV12303581	CABRIUVA S2	07/12/2020 07:34	07/12/2020 12:36	07/12/2020 07:34	07/12/2020 12:36	5,03	1	5,03	CHI
20201230985	IACIARA	IA21254267	IACIARA S2	07/12/2020 07:34	07/12/2020 11:49	07/12/2020 07:34	07/12/2020 11:49	4,24	1	4,24	CHI
20201230987	MOIPORA	MO12031774	IPORA	07/12/2020 07:34	07/12/2020 15:53	07/12/2020 07:34	07/12/2020 15:53	8,31	3	24,92	CHI
20201231001	T AQUARUA DE GOIAS	TQ12299894	ITABERAI S1	07/12/2020 07:35	07/12/2020 13:45	07/12/2020 07:35	07/12/2020 13:45	6,17	4	24,67	CHI
20201231825	MARA ROSA	MQ12236294	MARA ROSA	07/12/2020 07:35	07/12/2020 17:00	07/12/2020 07:35	07/12/2020 17:00	9,42	4	37,66	CHI
20201231014	CACU	CC21125607	CACHOEIRA ALTA	07/12/2020 07:36	07/12/2020 13:14	07/12/2020 07:36	07/12/2020 13:14	5,62	2	11,25	CHI
20201231015	LEOPOLDO DE BULHOES	LB12351257	DAIA S2	07/12/2020 07:36	07/12/2020 08:57	07/12/2020 07:36	07/12/2020 08:57	1,34	69	92,46	CHI
20201231020	NOVA IGUACU DE GOIAS	NH21070610	CAMPINORTE	07/12/2020 07:37	07/12/2020 09:10	07/12/2020 07:37	07/12/2020 09:10	1,54	1	1,54	CHI
20201231025	QUIRINOPOLIS	QI31053172	QUIRINOPOLIS	07/12/2020 07:37	07/12/2020 11:17	07/12/2020 07:37	07/12/2020 11:17	3,66	1	3,66	CHI
20201232527	ITUMBIARA	IT11166325	ITUMBIARA VELHA S1	07/12/2020 07:37	07/12/2020 21:30	07/12/2020 07:37	07/12/2020 21:30	13,87	10	138,72	CHI
20201234955	CROMINIA	CQ12007736	PONTALINA	07/12/2020 07:37	07/12/2020 21:57	07/12/2020 07:37	07/12/2020 21:57	14,32	16	229,11	CHI
20201231477	CALDAS NOVAS	CN21086402	RIO QUENTE	07/12/2020 07:38	07/12/2020 11:11	07/12/2020 07:38	07/12/2020 11:11	3,55	1	3,55	CHI
20201231043	OUIDOR	OU12061252	CATALAO S1	07/12/2020 07:39	07/12/2020 16:14	07/12/2020 07:39	07/12/2020 16:14	8,57	1	8,57	CHI
20201231047	CALDAS NOVAS	CN12182800LD	SERRA DE CALDAS	07/12/2020 07:40	07/12/2020 12:42	07/12/2020 07:40	07/12/2020 12:42	5,03	10	50,31	CHI
20201231049	MONTIVIDIU DO NORTE	MX11203497	PORANGATU	07/12/2020 07:40	08/12/2020 03:24	07/12/2020 07:40	08/12/2020 03:24	19,73	3	59,19	CHI
20201231955	BALIZA	BH12331164	CAIAPONIA	07/12/2020 07:40	09/12/2020 02:03	07/12/2020 07:40	09/12/2020 02:03	42,38	10	423,79	CHI
20201231064	FORMOSA	FA21376628	ITUIQUIRA	07/12/2020 07:42	07/12/2020 15:40	07/12/2020 07:42	07/12/2020 15:40	7,96	1	7,96	CHI
20201231066	ANICUNS	AC12304649	ANICUNS	07/12/2020 07:42	07/12/2020 08:33	07/12/2020 07:42	07/12/2020 08:33	0,84	5	4,20	CHI
20201231244	CRISTALINA	KR12230241	CRISTALINA S2	07/12/2020 07:42	07/12/2020 17:44	07/12/2020 07:42	07/12/2020 17:44	10,03	5	50,16	CHI
20201231073	SAO LUIS DE MONTES BELOS	10003695180	SAO LUIZ DOS MONTES BELOS	07/12/2020 07:43	07/12/2020 10:18	07/12/2020 07:43	07/12/2020 10:18	2,57	1	2,57	CHI
20201231077	SILVANIA	SV12103757	VIANOPOLIS	07/12/2020 07:44	07/12/2020 10:33	07/12/2020 07:44	07/12/2020 10:33	2,81	1	2,81	CHI
20201231078	RIO VERDE	RV12076307	CACHOEIRA ALTA	07/12/2020 07:44	07/12/2020 14:53	07/12/2020 07:44	07/12/2020 14:53	7,15	4	28,61	CHI
20201232004	FORMOSO	TB12051886	PORANGATU	07/12/2020 07:44	07/12/2020 11:47	07/12/2020 07:44	07/12/2020 11:47	4,05	2	8,10	CHI
20201232004	TROMBAS	TB12051886	PORANGATU	07/12/2020 07:44	07/12/2020 11:47	07/12/2020 07:44	07/12/2020 11:47	4,05	24	97,18	CHI
20201231082	QUIRINOPOLIS	QI32255692	QUIRINOPOLIS	07/12/2020 07:45	07/12/2020 09:56	07/12/2020 07:45	07/12/2020 09:56	2,18	18	39,24	CHI
20201231092	SAO LUIS DE MONTES BELOS	SL21332889	SAO LUIZ DOS MONTES BELOS	07/12/2020 07:45	07/12/2020 11:43	07/12/2020 07:45	07/12/2020 11:43	3,95	1	3,95	CHI
20201231278	CALDAS DO SUL	TI21355501	MINACU	07/12/2020 07:45	07/12/2020 15:08	07/12/2020 07:45	07/12/2020 15:08	7,37	1	7,37	CHI
20201231094	MARA ROSA	2260001598	MARA ROSA	07/12/2020 07:46	08/12/2020 09:29	07/12/2020 07:46	08/12/2020 09:29	25,71	1	25,71	CHI
20201231095	VILA PROPICIO	PV12255981	GOIANESIA S1	07/12/2020 07:46	07/12/2020 17:15	07/12/2020 07:46	07/12/2020 17:15	9,48	2	18,96	CHI
20201231102	JARAGUA	JA21345657	JARAGUA	07/12/2020 07:46	07/12/2020 13:27	07/12/2020 07:46	07/12/2020 13:27	5,67	1	5,67	CHI
20201231111	LEOPOLDO DE BULHOES	870000949	DAIA S2	07/12/2020 07:47	07/12/2020 10:09	07/12/2020 07:47	07/12/2020 10:09	2,36	1	2,36	CHI
20201231113	GOIANIA	10003548188	FERROVIARIO S1	07/12/2020 07:47	07/12/2020 09:18	07/12/2020 07:47	07/12/2020 09:18	1,51	1	1,51	CHI

20201233633	SANTO ANTONIO DE GOIAS	BW12291579	NEROPOLIS S1	07/12/2020 07:47	07/12/2020 15:58	07/12/2020 07:47	07/12/2020 15:58	8,18	2	16,37	CHI
20201233633	GOIANIRA	BW12291579	NEROPOLIS S1	07/12/2020 07:47	07/12/2020 15:58	07/12/2020 07:47	07/12/2020 15:58	8,18	3	24,55	CHI
20201231116	RIO VERDE	RV21306312	RIO VERDE S2	07/12/2020 07:48	07/12/2020 13:32	07/12/2020 07:48	07/12/2020 13:32	5,75	1	5,75	CHI
20201231120	PARAUNA	980028802	PARAUNA	07/12/2020 07:48	08/12/2020 04:43	07/12/2020 07:48	08/12/2020 04:43	20,93	1	20,93	CHI
20201231122	ARAGUAPAZ	AZ12234927	GOIAS	07/12/2020 07:48	07/12/2020 16:28	07/12/2020 07:48	07/12/2020 16:28	8,66	1	8,66	CHI
20201231123	PORANGATU	PO12088718	PORANGATU	07/12/2020 07:48	07/12/2020 10:52	07/12/2020 07:48	07/12/2020 10:52	3,05	4	12,22	CHI
20201231125	IPORA	IR12381025	IPORA	07/12/2020 07:48	07/12/2020 11:47	07/12/2020 07:48	07/12/2020 11:47	3,97	13	51,60	CHI
20201231129	MATRINCHA	MP12250891	MATRINCHA	07/12/2020 07:49	08/12/2020 09:36	07/12/2020 07:49	08/12/2020 09:36	25,78	1	25,78	CHI
20201231138	GOIANIA	10370262	CARAJAS S2	07/12/2020 07:49	07/12/2020 09:18	07/12/2020 07:49	07/12/2020 09:18	1,47	1	1,47	CHI
20201231157	TRINDADE	TR12326279	TRINDADE	07/12/2020 07:49	07/12/2020 12:48	07/12/2020 07:49	07/12/2020 12:48	4,98	4	19,91	CHI
20201231139	TROMBAS	TB21185282	PORANGATU	07/12/2020 07:50	07/12/2020 22:01	07/12/2020 07:50	07/12/2020 22:01	14,18	2	28,36	CHI
20201231142	RIO VERDE	630428621	RIO VERDE S2	07/12/2020 07:50	07/12/2020 12:59	07/12/2020 07:50	07/12/2020 12:59	5,15	1	5,15	CHI
20201231148	LUZIANIA	LZ12076061	MARAJOARA	07/12/2020 07:50	07/12/2020 09:55	07/12/2020 07:50	07/12/2020 09:55	2,07	1	2,07	CHI
20201231149	SERRANOPOLIS	SX21336916	JATAI S1	07/12/2020 07:50	08/12/2020 07:05	07/12/2020 07:50	08/12/2020 07:05	23,24	2	46,47	CHI
20201231160	MONTE ALEGRE DE GOIAS	MA21150386	SAO DOMINGOS	07/12/2020 07:52	07/12/2020 08:58	07/12/2020 07:52	07/12/2020 08:58	1,09	1	1,09	CHI
20201231167	COCALZINHO DE GOIAS	ZN12284977	COCALZINHO	07/12/2020 07:52	07/12/2020 14:58	07/12/2020 07:52	07/12/2020 14:58	7,08	3	21,25	CHI
20201231821	JESUPOLIS	SR12130200	INHUMAS S1	07/12/2020 07:52	07/12/2020 16:30	07/12/2020 07:52	07/12/2020 16:30	8,63	15	129,38	CHI
20201231171	RIO VERDE	RV21322194	MONTIVIDIU T	07/12/2020 07:53	07/12/2020 15:23	07/12/2020 07:53	07/12/2020 15:23	7,49	1	7,49	CHI
20201231174	CRISTALINA	KR21168492	PAMPLONA	07/12/2020 07:53	07/12/2020 12:26	07/12/2020 07:53	07/12/2020 10:41	2,80	1	2,80	CHI
20201231174	CRISTALINA	KR12163676RE	PAMPLONA	07/12/2020 07:53	07/12/2020 12:26	07/12/2020 10:59	07/12/2020 12:26	1,45	27	39,23	CHI
20201231174	DISTRITO FEDERAL	KR12163676RE	PAMPLONA	07/12/2020 07:53	07/12/2020 12:26	07/12/2020 10:59	07/12/2020 12:26	1,45	2	2,91	CHI
20201231174	LUZIANIA	KR12163676RE	PAMPLONA	07/12/2020 07:53	07/12/2020 12:26	07/12/2020 10:59	07/12/2020 12:26	1,45	2	2,91	CHI
20201231176	CACHOEIRA ALTA	CA12196169	CACHOEIRA ALTA	07/12/2020 07:54	07/12/2020 11:07	07/12/2020 07:54	07/12/2020 11:07	3,21	4	12,86	CHI
20201231179	GOIANDIRA	GD12040383	CATALAO S1	07/12/2020 07:54	07/12/2020 10:37	07/12/2020 07:54	07/12/2020 10:37	2,71	4	10,84	CHI
20201231185	GUAPO	710024666	GUAPO S1	07/12/2020 07:54	07/12/2020 22:24	07/12/2020 07:54	07/12/2020 22:24	14,49	1	14,49	CHI
20201231733	AVELINOPOLIS	AC12323606	ANICUNS	07/12/2020 07:54	07/12/2020 10:50	07/12/2020 07:54	07/12/2020 10:50	2,93	1	2,93	CHI
20201231733	ANICUNS	AC12323606	ANICUNS	07/12/2020 07:54	07/12/2020 10:50	07/12/2020 07:54	07/12/2020 10:50	2,93	12	35,11	CHI
20201231733	ITABERAI	AC12323606	ANICUNS	07/12/2020 07:54	07/12/2020 10:50	07/12/2020 07:54	07/12/2020 10:50	2,93	3	8,78	CHI
20201235092	ARAGOIANIA	AO11129263	GUAPO S2	07/12/2020 07:55	07/12/2020 20:38	07/12/2020 07:55	07/12/2020 20:38	12,71	25	317,76	CHI
20201231197	ITARUMA	10003319405	CACHOEIRA ALTA	07/12/2020 07:56	07/12/2020 10:14	07/12/2020 07:56	07/12/2020 10:14	2,30	1	2,30	CHI
20201231199	GOIANIA	11868764	GOIANIA LESTE S2	07/12/2020 07:56	07/12/2020 09:51	07/12/2020 07:56	07/12/2020 09:51	1,91	1	1,91	CHI
20201231471	DOVERLANDIA	DV12139906	CAIAPONIA	07/12/2020 07:56	08/12/2020 13:00	07/12/2020 07:56	08/12/2020 13:00	29,06	10	290,62	CHI
20201231755	MAIRIPOTABA	CQ12000224	PONTALINA	07/12/2020 07:56	07/12/2020 13:08	07/12/2020 07:56	07/12/2020 13:08	5,20	2	10,39	CHI
20201231755	CROMINIA	CQ12000224	PONTALINA	07/12/2020 07:56	07/12/2020 13:08	07/12/2020 07:56	07/12/2020 13:08	5,20	3	15,59	CHI
20201231838	FAINA	FC12159226	ITAPURANGA	07/12/2020 07:56	07/12/2020 16:54	07/12/2020 07:56	07/12/2020 16:54	8,96	9	80,61	CHI
20201231209	JATAI	JT21129658	JATAI S2	07/12/2020 07:57	08/12/2020 07:47	07/12/2020 07:57	08/12/2020 07:47	23,83	1	23,83	CHI
20201231211	CAMPO ALEGRE DE GOIAS	CM21161412	CAMPO ALEGRE DE GOIAS	07/12/2020 07:57	07/12/2020 12:45	07/12/2020 07:57	07/12/2020 12:45	4,79	1	4,79	CHI
20201232537	PONTALINA	MI12166303	PONTALINA	07/12/2020 07:57	07/12/2020 20:22	07/12/2020 07:57	07/12/2020 20:22	12,40	3	37,20	CHI
20201232537	MAIRIPOTABA	MI12166303	PONTALINA	07/12/2020 07:57	07/12/2020 20:22	07/12/2020 07:57	07/12/2020 20:22	12,40	1	12,40	CHI
20201231240	APARECIDA DE GOIANIA	14116108	REAL S2	07/12/2020 07:59	07/12/2020 09:54	07/12/2020 07:59	07/12/2020 09:54	1,91	1	1,91	CHI
20201231245	ITABERAI	IB12379732	ITABERAI S1	07/12/2020 07:59	07/12/2020 13:07	07/12/2020 07:59	07/12/2020 13:07	5,12	2	10,24	CHI
20201233963	CRISTALINA	KR21171601	CRISTALINA S2	07/12/2020 07:59	07/12/2020 17:34	07/12/2020 07:59	07/12/2020 17:34	9,57	2	19,14	CHI
20201231248	MOSSAMEDES	KB21000068	ANICUNS	07/12/2020 08:00	07/12/2020 18:56	07/12/2020 08:00	07/12/2020 18:56	10,93	1	10,93	CHI
20201234694	BURITINOPOLIS	SU12374375	SANTA RITA DO ARAGUAIA	07/12/2020 08:00	07/12/2020 22:08	07/12/2020 08:00	07/12/2020 22:08	14,12	1	14,12	CHI
20201234694	SANTA RITA DO ARAGUAIA	SU12374375	SANTA RITA DO ARAGUAIA	07/12/2020 08:00	07/12/2020 22:08	07/12/2020 08:00	07/12/2020 22:08	14,12	6	84,72	CHI
20201231256	AMORINOPOLIS	AM21202894	IPORA	07/12/2020 08:01	07/12/2020 16:04	07/12/2020 08:01	07/12/2020 16:04	8,05	1	8,05	CHI
20201231260	SILVANIA	SV12077012	VIANOPOLIS	07/12/2020 08:01	07/12/2020 09:47	07/12/2020 08:01	07/12/2020 09:47	1,76	7	12,33	CHI
20201231261	JUSSARA	JR12020137	JUSSARA	07/12/2020 08:01	08/12/2020 01:44	07/12/2020 08:01	08/12/2020 01:44	17,71	1	17,71	CHI
20201233440	ARAGOIANIA	AO12092571	GUAPO S2	07/12/2020 08:01	07/12/2020 17:22	07/12/2020 08:01	07/12/2020 16:12	8,18	31	253,55	CHI
20201233440	ARAGOIANIA	AO12092571	GUAPO S2	07/12/2020 08:01	07/12/2020 17:22	07/12/2020 08:01	07/12/2020 17:22	9,34	33	308,14	CHI
20201231272	CAVALCANTE	CJ11278463	NIQUELANDIA SUBTRANSMISSAO	07/12/2020 08:02	07/12/2020 20:05	07/12/2020 08:02	07/12/2020 20:05	12,05	29	349,39	CHI

20201231798	CAIAPONIA	CP12075058	CAIAPONIA	07/12/2020 08:02	09/12/2020 19:00	07/12/2020 08:02	08/12/2020 13:17	29,25	10	292,51	CHI
20201231798	CAIAPONIA	CP12075058	CAIAPONIA	07/12/2020 08:02	09/12/2020 19:00	08/12/2020 17:04	08/12/2020 18:01	0,95	10	9,54	CHI
20201231798	CAIAPONIA	CP12075058	CAIAPONIA	07/12/2020 08:02	09/12/2020 19:00	07/12/2020 08:02	09/12/2020 15:54	55,88	1	55,88	CHI
20201231798	JATAI	CP12075058	CAIAPONIA	07/12/2020 08:02	09/12/2020 19:00	07/12/2020 08:02	09/12/2020 15:54	55,88	3	167,63	CHI
20201231798	RIO VERDE	CP12075058	CAIAPONIA	07/12/2020 08:02	09/12/2020 19:00	07/12/2020 08:02	09/12/2020 15:54	55,88	4	223,50	CHI
20201231798	CAIAPONIA	CP12075032	CAIAPONIA	07/12/2020 08:02	09/12/2020 19:00	07/12/2020 08:02	09/12/2020 19:00	58,96	10	589,64	CHI
20201234866	VARJAO	AO32097674	GUAPO S2	07/12/2020 08:02	07/12/2020 19:43	07/12/2020 08:02	07/12/2020 19:43	11,68	4	46,70	CHI
20201231283	MONTIVIDIU DO NORTE	MX21208302	PORANGATU	07/12/2020 08:03	07/12/2020 22:36	07/12/2020 08:03	07/12/2020 22:36	14,54	1	14,54	CHI
20201231285	PADRE BERNARDO	PB21330891	PADRE BERNARDO	07/12/2020 08:03	07/12/2020 11:17	07/12/2020 08:03	07/12/2020 11:17	3,22	1	3,22	CHI
20201231287	ARUANA	AK12259762	ARUANA	07/12/2020 08:03	07/12/2020 13:11	07/12/2020 08:03	07/12/2020 13:11	5,12	3	15,35	CHI
20201231291	LUZIANIA	SV12249236	VIANOPOLIS	07/12/2020 08:04	07/12/2020 11:28	07/12/2020 08:04	07/12/2020 11:28	3,40	2	6,80	CHI
20201231293	APARECIDA DE GOIANIA	10006555797	REAL S2	07/12/2020 08:04	07/12/2020 12:16	07/12/2020 08:04	07/12/2020 12:16	4,20	1	4,20	CHI
20201231301	VIANOPOLIS	VN21159793	VIANOPOLIS	07/12/2020 08:04	07/12/2020 09:26	07/12/2020 08:04	07/12/2020 09:26	1,36	2	2,71	CHI
20201231304	LUZIANIA	LZ21118932	RIO VERMELHO	07/12/2020 08:05	07/12/2020 14:12	07/12/2020 08:05	07/12/2020 14:12	6,12	1	6,12	CHI
20201234188	DOVERLANDIA	MY12209669	PARQUE DAS EMAS	07/12/2020 08:05	08/12/2020 11:37	07/12/2020 08:05	08/12/2020 11:37	27,53	12	330,37	CHI
20201235972	SERRANOPOLIS	SX12390578	JATAI S1	07/12/2020 08:05	08/12/2020 12:46	07/12/2020 08:05	08/12/2020 12:46	28,67	20	573,44	CHI
20201231319	INHUMAS	IN21287281	INHUMAS S2	07/12/2020 08:06	07/12/2020 09:35	07/12/2020 08:06	07/12/2020 09:35	1,48	2	2,97	CHI
20201231323	CACU	CC21207543	CACHOEIRA ALTA	07/12/2020 08:06	07/12/2020 12:24	07/12/2020 08:06	07/12/2020 12:24	4,29	1	4,29	CHI
20201232921	CAIAPONIA	CP12374976	PALESTINA	07/12/2020 08:06	07/12/2020 16:46	07/12/2020 08:06	07/12/2020 16:46	8,66	6	51,96	CHI
20201231339	CRISTALINA	KR11276519	CRISTALINA S2	07/12/2020 08:07	07/12/2020 14:42	07/12/2020 08:07	07/12/2020 14:42	6,58	1	6,58	CHI
20201231675	JUSSARA	JR12008743	BRITANIA	07/12/2020 08:07	07/12/2020 14:30	07/12/2020 08:07	07/12/2020 14:30	6,37	38	241,95	CHI
20201232273	PONTALINA	PK12390270	PONTALINA	07/12/2020 08:07	07/12/2020 13:54	07/12/2020 08:07	07/12/2020 13:54	5,78	7	40,45	CHI
20201232273	MAIRIPOTABA	PK12390270	PONTALINA	07/12/2020 08:07	07/12/2020 13:54	07/12/2020 08:07	07/12/2020 13:54	5,78	1	5,78	CHI
20201231345	QUIRINOPOLIS	QI12296563	QUIRINOPOLIS	07/12/2020 08:08	07/12/2020 14:30	07/12/2020 08:08	07/12/2020 14:30	6,37	5	31,83	CHI
20201231346	AGUA FRIA DE GOIAS	TL21204687	SAO JOAO D ALIANCA	07/12/2020 08:08	07/12/2020 09:57	07/12/2020 08:08	07/12/2020 09:57	1,82	1	1,82	CHI
20201231350	ALEXANIA	AX11252276	ALEXANIA	07/12/2020 08:08	07/12/2020 10:26	07/12/2020 08:08	07/12/2020 10:26	2,29	5	11,46	CHI
20201231351	MINEIROS	1390158618	PARQUE DAS EMAS	07/12/2020 08:08	07/12/2020 14:46	07/12/2020 08:08	07/12/2020 14:46	6,63	1	6,63	CHI
20201231356	CIDADE OCIDENTAL	LZ21033253	MARAJOARA	07/12/2020 08:09	07/12/2020 10:38	07/12/2020 08:09	07/12/2020 10:38	2,48	1	2,48	CHI
20201231358	RIO VERDE	RV21326777	CABRIUVA S2	07/12/2020 08:09	07/12/2020 11:01	07/12/2020 08:09	07/12/2020 11:01	2,86	1	2,86	CHI
20201231359	GOIANIA	10765610	ATLANTICO S1	07/12/2020 08:09	07/12/2020 09:36	07/12/2020 08:09	07/12/2020 09:36	1,44	1	1,44	CHI
20201233293	PIRENOPOLIS	PV12381259	CORUMBA	07/12/2020 08:09	08/12/2020 07:48	07/12/2020 08:09	08/12/2020 07:48	23,64	3	70,92	CHI
20201231366	NOVA AURORA	NE12149259	CATALAO S1	07/12/2020 08:10	07/12/2020 13:02	07/12/2020 08:10	07/12/2020 13:02	4,87	4	19,46	CHI
20201231368	LUZIANIA	LZ21168105	VIANOPOLIS	07/12/2020 08:10	07/12/2020 14:40	07/12/2020 08:10	07/12/2020 14:40	6,50	2	12,99	CHI
20201231370	SAO LUIS DE MONTES BELOS	SL12180010	SAO LUIZ DOS MONTES BELOS	07/12/2020 08:10	07/12/2020 09:21	07/12/2020 08:10	07/12/2020 09:21	1,18	571	673,62	CHI
20201231372	GOIAS	GS11217117	GOIAS	07/12/2020 08:10	07/12/2020 10:52	07/12/2020 08:10	07/12/2020 10:52	2,69	1	2,69	CHI
20201234374	RIO QUENTE	RQ12100108	RIO QUENTE	07/12/2020 08:10	07/12/2020 17:35	07/12/2020 08:10	07/12/2020 17:35	9,42	8	75,36	CHI
20201231396	ALTO PARAISO DE GOIAS	5880002875	NIQUELANDIA SUBTRANSMISSAO	07/12/2020 08:12	07/12/2020 19:08	07/12/2020 08:12	07/12/2020 19:08	10,92	1	10,92	CHI
20201231402	ARUANA	AK11310717	ARUANA	07/12/2020 08:13	07/12/2020 09:54	07/12/2020 08:13	07/12/2020 09:54	1,68	15	25,23	CHI
20201231403	MONTES CLAROS DE GOIAS	ME12078959	IPORA	07/12/2020 08:13	07/12/2020 15:04	07/12/2020 08:13	07/12/2020 15:04	6,85	3	20,54	CHI
20201231408	OURO VERDE DE GOIAS	OV21017712	NEROPOLIS S1	07/12/2020 08:13	07/12/2020 11:06	07/12/2020 08:13	07/12/2020 11:06	2,87	1	2,87	CHI
20201231444	TEREZOPOLIS DE GOIAS	GP12000094	DAIA S2	07/12/2020 08:13	07/12/2020 11:10	07/12/2020 08:13	07/12/2020 11:10	2,94	20	58,90	CHI
20201231444	GOIANAPOLIS	GP12000094	DAIA S2	07/12/2020 08:13	07/12/2020 11:10	07/12/2020 08:13	07/12/2020 11:10	2,94	4	11,78	CHI
20201231416	CRISTALINA	10020286170	CRISTALINA S2	07/12/2020 08:14	07/12/2020 10:28	07/12/2020 08:14	07/12/2020 10:28	2,23	1	2,23	CHI
20201231420	CAMPINORTE	2040031619	CAMPINORTE	07/12/2020 08:14	07/12/2020 10:23	07/12/2020 08:14	07/12/2020 10:23	2,14	1	2,14	CHI
20201231423	LEOPOLDO DE BULHOES	870002909	DAIA S2	07/12/2020 08:15	07/12/2020 11:04	07/12/2020 08:15	07/12/2020 11:04	2,82	1	2,82	CHI
20201231427	MINACU	4020010299	MINACU	07/12/2020 08:15	07/12/2020 17:47	07/12/2020 08:15	07/12/2020 17:47	9,53	1	9,53	CHI
20201231432	FAINA	FC12057965	GOIAS	07/12/2020 08:15	07/12/2020 19:14	07/12/2020 08:15	07/12/2020 19:14	10,97	6	65,84	CHI
20201231978	MORRO AGUDO DE GOIAS	MS12169397	ITAPURANGA	07/12/2020 08:15	07/12/2020 11:28	07/12/2020 08:15	07/12/2020 11:28	3,20	5	16,01	CHI
20201232849	PADRE BERNARDO	PB12305108	PADRE BERNARDO	07/12/2020 08:15	07/12/2020 13:09	07/12/2020 08:15	07/12/2020 13:09	4,90	13	63,64	CHI
20201232945	PIRENOPOLIS	PV12197771	CORUMBA	07/12/2020 08:15	07/12/2020 13:38	07/12/2020 08:15	07/12/2020 13:38	5,38	5	26,90	CHI
20201234754	JAUPACI	JP12287872	IPORA	07/12/2020 08:15	08/12/2020 11:48	07/12/2020 08:15	08/12/2020 11:48	27,55	14	385,66	CHI

20201231445	CRISTALINA	KR21219771	CRISTALINA S2	07/12/2020 08:16	07/12/2020 11:40	07/12/2020 08:16	07/12/2020 11:40	3,39	1	3,39	CHI
20201231455	JATAI	JT21304380	JATAI S1	07/12/2020 08:17	07/12/2020 10:15	07/12/2020 08:17	07/12/2020 10:15	1,97	2	3,94	CHI
20201231457	MONTES CLAROS DE GOIAS	ME12402923	BRITANIA	07/12/2020 08:17	07/12/2020 19:52	07/12/2020 08:17	07/12/2020 19:52	11,58	1	11,58	CHI
20201231469	VIANOPOLIS	VN21079975	VIANOPOLIS	07/12/2020 08:18	07/12/2020 23:59	07/12/2020 08:18	07/12/2020 23:59	15,67	1	15,67	CHI
20201231474	VILA PROPICIO	NP12298204	GOIANESIA S1	07/12/2020 08:18	07/12/2020 22:13	07/12/2020 08:18	07/12/2020 22:13	13,90	2	27,80	CHI
20201231476	CACU	CC12061446	CACHOEIRA ALTA	07/12/2020 08:18	07/12/2020 13:27	07/12/2020 08:18	07/12/2020 13:27	5,13	2	10,27	CHI
20201231692	GOIATUBA	JV12157811	GOIATUBA S1	07/12/2020 08:18	07/12/2020 11:39	07/12/2020 08:18	07/12/2020 11:39	3,34	4	13,37	CHI
20201231479	RIO VERDE	RV21136141	SANTA HELENA S1	07/12/2020 08:19	08/12/2020 01:55	07/12/2020 08:19	08/12/2020 01:55	17,59	1	17,59	CHI
20201231501	MOIPORA	MO21006812	SAO LUIZ DOS MONTES BELOS	07/12/2020 08:20	08/12/2020 09:00	07/12/2020 08:20	08/12/2020 09:00	24,68	1	24,68	CHI
20201231817	GAMELEIRA DE GOIAS	SV12017613	ANAPOLIS UNIVERSITARIO S2	07/12/2020 08:20	07/12/2020 10:50	07/12/2020 08:20	07/12/2020 10:50	2,49	6	14,95	CHI
20201230821	TRINDADE	TR16414822	TRINDADE	07/12/2020 08:21	07/12/2020 11:26	07/12/2020 10:39	07/12/2020 10:53	0,24	142	33,80	CHI
20201230821	TRINDADE	TR12237597LD	TRINDADE	07/12/2020 08:21	07/12/2020 11:26	07/12/2020 08:21	07/12/2020 11:26	3,08	934	2876,72	CHI
20201231513	TRINDADE	10001152970	TRINDADE	07/12/2020 08:21	07/12/2020 14:54	07/12/2020 08:21	07/12/2020 14:54	6,54	1	6,54	CHI
20201234011	MONTIVIDIU DO NORTE	MX12203419	PORANGATU	07/12/2020 08:21	07/12/2020 22:00	07/12/2020 08:21	07/12/2020 22:00	13,64	93	1268,86	CHI
20201231524	ALEXANIA	480007317	ALEXANIA	07/12/2020 08:22	07/12/2020 12:24	07/12/2020 08:22	07/12/2020 12:24	4,03	1	4,03	CHI
20201231531	CATALAO	CT12286877	CATALAO S1	07/12/2020 08:23	07/12/2020 10:42	07/12/2020 08:23	07/12/2020 10:42	2,31	2	4,63	CHI
20201231532	QUIRINO	CA21228925	CACHOEIRA ALTA	07/12/2020 08:23	07/12/2020 12:53	07/12/2020 08:23	07/12/2020 12:53	4,50	1	4,50	CHI
20201232084	FORMOSA	FA12383272	ITUIQUIRA	07/12/2020 08:23	07/12/2020 11:30	07/12/2020 08:23	07/12/2020 11:30	3,13	39	121,95	CHI
20201231541	NIQUELANDIA	NQ11048783	NIQUELANDIA SUBTRANSMISSAO	07/12/2020 08:24	07/12/2020 11:37	07/12/2020 08:24	07/12/2020 11:37	3,21	128	411,41	CHI
20201231543	COCALZINHO DE GOIAS	ZN12302266	COCALZINHO	07/12/2020 08:24	07/12/2020 15:58	07/12/2020 08:24	07/12/2020 15:58	7,56	8	60,49	CHI
20201231546	AGUA FRIA DE GOIAS	TL21218505	SAO JOAO D ALIANCA	07/12/2020 08:24	07/12/2020 12:44	07/12/2020 08:24	07/12/2020 12:44	4,33	1	4,33	CHI
20201231594	SANCLERLANDIA	SC12388895	FIRMINOPOLIS S2	07/12/2020 08:24	07/12/2020 11:46	07/12/2020 08:24	07/12/2020 11:46	3,36	3	10,09	CHI
20201231577	TRINDADE	TR11005101	TRINDADE	07/12/2020 08:25	07/12/2020 13:12	07/12/2020 12:26	07/12/2020 13:12	0,77	113	86,66	CHI
20201231580	ORIZONA	OZ11202891	PIRES DO RIO S2	07/12/2020 08:25	07/12/2020 10:58	07/12/2020 08:25	07/12/2020 10:58	2,55	9	22,92	CHI
20201232506	FAINA	FC12158868	GOIAS	07/12/2020 08:25	07/12/2020 12:53	07/12/2020 08:25	07/12/2020 12:53	4,46	17	75,84	CHI
20201232506	ARAGUAPAZ	FC12158868	GOIAS	07/12/2020 08:25	07/12/2020 12:53	07/12/2020 08:25	07/12/2020 12:53	4,46	43	191,84	CHI
20201233758	BELA VISTA DE GOIAS	BV12020422	BELA VISTA S2	07/12/2020 08:25	07/12/2020 16:16	07/12/2020 08:25	07/12/2020 16:16	7,85	6	47,09	CHI
20201233582	SANTA HELENA DE GOIAS	SH12301283	IPEGUARI	07/12/2020 08:27	07/12/2020 17:28	07/12/2020 08:27	07/12/2020 17:28	9,02	7	63,12	CHI
20201233376	CAIAPONIA	CP12200873	PALESTINA	07/12/2020 08:28	07/12/2020 19:14	07/12/2020 08:28	07/12/2020 19:14	10,76	60	645,63	CHI
20201234178	FLORES DE GOIAS	FB12361337	FLORES DE GOIAS	07/12/2020 08:28	07/12/2020 23:44	07/12/2020 08:28	07/12/2020 23:44	15,26	6	91,55	CHI
20201231610	MUNDO NOVO DE GOIAS	MH11269482	NOVA CRIXAS	07/12/2020 08:29	07/12/2020 14:47	07/12/2020 08:29	07/12/2020 14:47	6,30	1	6,30	CHI
20201231612	PIRES DO RIO	OZ21128983	PIRES DO RIO S2	07/12/2020 08:29	07/12/2020 20:39	07/12/2020 08:29	07/12/2020 20:39	12,16	1	12,16	CHI
20201231618	BALIZA	BH12356619	BOM JARDIM	07/12/2020 08:29	07/12/2020 15:55	07/12/2020 08:29	07/12/2020 15:55	7,42	14	103,92	CHI
20201232239	CORUMBAIBA	CI12107484	VILA CORUMBA	07/12/2020 08:29	07/12/2020 12:41	07/12/2020 08:29	07/12/2020 12:41	4,19	3	12,56	CHI
20201232459	SANTO ANTONIO DO DESCOBERTO	SN12313462	MARAJOARA	07/12/2020 08:29	07/12/2020 13:46	07/12/2020 08:29	07/12/2020 13:46	5,27	8	42,17	CHI
20201231623	CACHOEIRA DOURADA	CD21000050	CACHOEIRA DOURADA	07/12/2020 08:30	07/12/2020 23:19	07/12/2020 08:30	07/12/2020 23:19	14,81	1	14,81	CHI
20201231626	JANDAIA	JD21301616	ACREUNA	07/12/2020 08:30	07/12/2020 11:18	07/12/2020 08:30	07/12/2020 11:18	2,79	1	2,79	CHI
20201231631	CATALAO	CT1231544	CATALAO S1	07/12/2020 08:30	07/12/2020 11:11	07/12/2020 08:30	07/12/2020 11:11	2,67	1	2,67	CHI
20201231636	IPORA	10032505246	IPORA	07/12/2020 08:31	07/12/2020 15:58	07/12/2020 08:31	07/12/2020 15:58	7,45	1	7,45	CHI
20201231641	APARECIDA DE GOIANIA	14334525	INDEPENDENCIA S2	07/12/2020 08:31	07/12/2020 10:51	07/12/2020 08:31	07/12/2020 10:51	2,33	1	2,33	CHI
20201231644	LUZIANIA	LZ21139657	MARAJOARA	07/12/2020 08:31	07/12/2020 14:31	07/12/2020 08:31	07/12/2020 14:31	5,99	1	5,99	CHI
20201238188	CAIAPONIA	CP12269004	CAIAPONIA	07/12/2020 08:31	08/12/2020 11:00	07/12/2020 08:31	08/12/2020 11:00	26,48	5	132,40	CHI
20201231645	URUACU	UR21237431	URUACU	07/12/2020 08:32	07/12/2020 11:00	07/12/2020 08:32	07/12/2020 11:00	2,47	1	2,47	CHI
20201231646	PORANGATU	PO12253874	PORANGATU	07/12/2020 08:32	07/12/2020 13:19	07/12/2020 08:32	07/12/2020 13:19	4,78	5	23,91	CHI
20201231653	NOVA CRIXAS	NA31057398	NOVA CRIXAS	07/12/2020 08:32	07/12/2020 11:02	07/12/2020 08:32	07/12/2020 11:02	2,49	1	2,49	CHI
20201231655	CORUMBA DE GOIAS	CB21382154	CORUMBA	07/12/2020 08:32	07/12/2020 12:48	07/12/2020 08:32	07/12/2020 12:48	4,26	1	4,26	CHI
20201231656	NIQUELANDIA	NQ21345149	BARRO ALTO	07/12/2020 08:32	07/12/2020 13:13	07/12/2020 08:32	07/12/2020 13:13	4,67	1	4,67	CHI
20201231658	MONTIVIDIU	10008513528	MONTIVIDIU T	07/12/2020 08:32	07/12/2020 21:55	07/12/2020 08:32	07/12/2020 21:55	13,37	1	13,37	CHI
20201232078	APARECIDA DE GOIANIA	AP11265301	REAL S1	07/12/2020 08:32	07/12/2020 15:50	07/12/2020 08:32	07/12/2020 15:50	7,29	30	218,55	CHI
20201231662	GOIANIA	GN11180112	XAVANTES	07/12/2020 08:33	07/12/2020 10:47	07/12/2020 08:33	07/12/2020 10:47	2,23	116	258,13	CHI
20201231678	VILA PROPICIO	NP11090261	GOIANESIA S1	07/12/2020 08:34	07/12/2020 15:27	07/12/2020 08:34	07/12/2020 15:27	6,87	96	659,92	CHI

20201231679	AMARALINA	LC11270200	SAO MIGUEL DO ARAGUAIA	07/12/2020 08:34	08/12/2020 03:35	07/12/2020 08:34	08/12/2020 03:35	19,01	1	19,01	CHI
20201231682	MONTIVIDIU DO NORTE	MX11203316	PORANGATU	07/12/2020 08:34	08/12/2020 02:40	07/12/2020 08:34	08/12/2020 02:40	18,09	1	18,09	CHI
20201234145	COCALZINHO DE GOIAS	ZN21185006	COCALZINHO	07/12/2020 08:34	07/12/2020 16:04	07/12/2020 08:34	07/12/2020 16:04	7,49	1	7,49	CHI
20201231685	APARECIDA DE GOIANIA	14044882	ATLANTICO S1	07/12/2020 08:35	07/12/2020 10:48	07/12/2020 08:35	07/12/2020 10:48	2,21	1	2,21	CHI
20201231687	BURITI DE GOIAS	BS21167209	FIRMINOPOLIS S2	07/12/2020 08:35	07/12/2020 10:22	07/12/2020 08:35	07/12/2020 10:22	1,77	1	1,77	CHI
20201231694	CACHOEIRA ALTA	CA21191620	CACHOEIRA ALTA	07/12/2020 08:36	07/12/2020 13:22	07/12/2020 08:36	07/12/2020 13:22	4,77	1	4,77	CHI
20201231703	PETROLINA DE GOIAS	PG12019040	PETROLINA	07/12/2020 08:37	08/12/2020 09:05	07/12/2020 08:37	08/12/2020 09:05	24,47	3	73,40	CHI
20201231705	PARANAIGUARA	PC12069008	QUIRINOPOLIS	07/12/2020 08:37	07/12/2020 16:06	07/12/2020 08:37	07/12/2020 16:06	7,48	1	7,48	CHI
20201231708	CORUMBAIBA	CI21081007	VILA CORUMBA	07/12/2020 08:37	07/12/2020 23:28	07/12/2020 08:37	07/12/2020 23:28	14,84	1	14,84	CHI
20201231709	SERRANOPOLIS	SX21318781	JATAI S1	07/12/2020 08:37	07/12/2020 23:17	07/12/2020 08:37	07/12/2020 23:17	14,65	8	117,22	CHI
20201231711	MOZARLANDIA	MZ12311290	MOZARLANDIA	07/12/2020 08:38	07/12/2020 12:43	07/12/2020 08:38	07/12/2020 12:43	4,08	3	12,24	CHI
20201231712	ITUMBIARA	IT11316727	ITUMBIARA NOVA	07/12/2020 08:38	08/12/2020 14:35	07/12/2020 08:38	08/12/2020 14:35	29,95	74	2215,93	CHI
20201231715	ALTO HORIZONTE	AJ12213238	SANTA TEREZINHA	07/12/2020 08:38	07/12/2020 13:18	07/12/2020 08:38	07/12/2020 13:18	4,65	1	4,65	CHI
20201231901	ARAGARCAS	AG12381009	ARAGARCAS	07/12/2020 08:38	07/12/2020 11:39	07/12/2020 08:38	07/12/2020 11:39	3,00	9	27,03	CHI
20201231721	FORMOSA	10002262426	ITUIQUIRA	07/12/2020 08:39	07/12/2020 21:11	07/12/2020 08:39	07/12/2020 21:11	12,53	1	12,53	CHI
20201231723	JARAGUA	JA21157783	JARAGUA	07/12/2020 08:39	07/12/2020 13:17	07/12/2020 08:39	07/12/2020 13:17	4,62	1	4,62	CHI
20201234333	ARAGOIANIA	AO21040735	GUAPU S2	07/12/2020 08:39	07/12/2020 21:31	07/12/2020 08:39	07/12/2020 21:31	12,86	1	12,86	CHI
20201231728	APARECIDA DE GOIANIA	14326048	REAL S2	07/12/2020 08:40	07/12/2020 12:38	07/12/2020 08:40	07/12/2020 12:38	3,96	1	3,96	CHI
20201231732	SILVANIA	SV21070044	DAIA S2	07/12/2020 08:40	07/12/2020 11:14	07/12/2020 08:40	07/12/2020 11:14	2,55	2	5,10	CHI
20201231979	IPAMERI	IP12332890	IPAMERI	07/12/2020 08:40	07/12/2020 17:28	07/12/2020 08:40	07/12/2020 17:28	8,79	17	149,39	CHI
20201231734	NOVA ROMA	ND12392238	IACIARA S2	07/12/2020 08:41	07/12/2020 15:59	07/12/2020 08:41	07/12/2020 15:59	7,30	235	1715,24	CHI
20201231737	FORMOSA	FA12242980	ITUIQUIRA	07/12/2020 08:41	07/12/2020 13:01	07/12/2020 08:41	07/12/2020 13:01	4,33	2	8,66	CHI
20201231739	TRINDADE	40249682	TRINDADE	07/12/2020 08:41	07/12/2020 10:59	07/12/2020 08:41	07/12/2020 10:59	2,29	1	2,29	CHI
20201231742	CRISTALINA	KR12090200	CRISTALINA S1	07/12/2020 08:41	07/12/2020 12:54	07/12/2020 08:41	07/12/2020 12:54	4,20	5	21,01	CHI
20201233470	LUZIANIA	LZ12304862	VIANOPOLIS	07/12/2020 08:42	07/12/2020 15:21	07/12/2020 08:42	07/12/2020 15:21	6,64	4	26,57	CHI
20201230991	MARA ROSA	MQ12391917	MARA ROSA	07/12/2020 08:43	07/12/2020 11:13	07/12/2020 08:43	07/12/2020 11:13	2,48	6	14,91	CHI
20201231752	ITUMBIARA	IT21257134	PARANAIBA	07/12/2020 08:43	08/12/2020 09:05	07/12/2020 08:43	08/12/2020 09:05	24,36	1	24,36	CHI
20201231753	CORUMBA DE GOIAS	CB12382361	CORUMBA	07/12/2020 08:43	07/12/2020 15:36	07/12/2020 08:43	07/12/2020 15:36	6,88	5	34,40	CHI
20201231754	JUSSARA	JR11390156	JUSSARA	07/12/2020 08:43	07/12/2020 13:19	07/12/2020 08:43	07/12/2020 13:19	4,60	6	27,58	CHI
20201231757	AGUAS LINDAS DE GOIAS	SN11117001	AGUAS LINDAS DE GOIAS S1	07/12/2020 08:43	07/12/2020 12:26	07/12/2020 08:43	07/12/2020 12:26	3,71	7	25,95	CHI
20201231766	MORRINHOS	MR12040738	GOIATUBA S1	07/12/2020 08:44	07/12/2020 11:13	07/12/2020 08:44	07/12/2020 11:13	2,47	3	7,41	CHI
20201231781	LUZIANIA	LZ21120160	MARAJOARA	07/12/2020 08:46	07/12/2020 17:03	07/12/2020 08:46	07/12/2020 17:03	8,28	1	8,28	CHI
20201231785	SANTA HELENA DE GOIAS	400025541	IPEGUARI	07/12/2020 08:46	08/12/2020 01:28	07/12/2020 08:46	08/12/2020 01:28	16,70	1	16,70	CHI
20201231788	CATALAO	CT12399856	CATALAO S1	07/12/2020 08:46	07/12/2020 11:32	07/12/2020 08:46	07/12/2020 11:32	2,75	6	16,52	CHI
20201231791	SAO LUIZ DO NORTE	SZ12066081	ITAPACI	07/12/2020 08:46	07/12/2020 09:34	07/12/2020 08:46	07/12/2020 09:34	0,79	7	5,51	CHI
20201231808	AMARALINA	LC12245307	MARA ROSA	07/12/2020 08:46	07/12/2020 14:47	07/12/2020 08:46	07/12/2020 14:47	6,01	5	30,07	CHI
20201231797	CRISTALINA	KR21379617	CRISTALINA S2	07/12/2020 08:47	07/12/2020 11:00	07/12/2020 08:47	07/12/2020 11:00	2,21	1	2,21	CHI
20201231800	SILVANIA	SV21079289	VIANOPOLIS	07/12/2020 08:47	07/12/2020 13:11	07/12/2020 08:47	07/12/2020 13:11	4,38	1	4,38	CHI
20201231904	BRITANIA	BT12009771	BRITANIA	07/12/2020 08:47	08/12/2020 10:26	07/12/2020 08:47	08/12/2020 10:26	25,65	9	230,84	CHI
20201232006	BRAZABRANTES	NV12272408	INHUMAS S1	07/12/2020 08:48	07/12/2020 11:43	07/12/2020 08:48	07/12/2020 11:43	2,91	60	174,58	CHI
20201232006	INHUMAS	NV12272408	INHUMAS S1	07/12/2020 08:48	07/12/2020 11:43	07/12/2020 08:48	07/12/2020 11:43	2,91	19	55,28	CHI
20201232006	NOVA VENEZA	NV12272408	INHUMAS S1	07/12/2020 08:48	07/12/2020 11:43	07/12/2020 08:48	07/12/2020 11:43	2,91	9	26,19	CHI
20201231807	MINEIROS	10012008905	PARQUE DAS EMAS	07/12/2020 08:49	08/12/2020 08:24	07/12/2020 08:49	08/12/2020 08:24	23,59	1	23,59	CHI
20201231812	CRISTALINA	KR12170316	PAMPLONA	07/12/2020 08:50	07/12/2020 16:31	07/12/2020 08:50	07/12/2020 16:31	7,68	1	7,68	CHI
20201231815	ITAPACI	IW21335683	ITAPACI	07/12/2020 08:50	07/12/2020 19:20	07/12/2020 08:50	07/12/2020 19:20	10,49	1	10,49	CHI
20201231816	ITABERAI	IB12300305	ITABERAI S2	07/12/2020 08:50	07/12/2020 15:54	07/12/2020 08:50	07/12/2020 15:54	7,06	4	28,22	CHI
20201231824	RIO VERDE	RV21260210	RIO VERDE S1	07/12/2020 08:51	07/12/2020 16:27	07/12/2020 08:51	07/12/2020 16:27	7,59	1	7,59	CHI
20201231828	LUZIANIA	KR21120575	CRISTALINA S2	07/12/2020 08:51	07/12/2020 16:31	07/12/2020 08:51	07/12/2020 16:31	7,66	1	7,66	CHI
20201231847	SILVANIA	SV21187072	DAIA S2	07/12/2020 08:53	07/12/2020 11:54	07/12/2020 08:53	07/12/2020 11:54	3,00	3	9,00	CHI
20201231853	ITAJA	IJ12370148	ITAJA S2	07/12/2020 08:54	07/12/2020 11:10	07/12/2020 08:54	07/12/2020 11:10	2,27	2	4,53	CHI
20201231868	FORMOSA	10007040197	ITUIQUIRA	07/12/2020 08:55	07/12/2020 12:43	07/12/2020 08:55	07/12/2020 12:43	3,79	1	3,79	CHI

20201231871	ITAPACI	IW21259675	ITAPACI	07/12/2020 08:55	07/12/2020 21:25	07/12/2020 08:55	07/12/2020 21:25	12,49	1	12,49	CHI
20201231872	PONTALINA	PK12046026	GOIATUBA S1	07/12/2020 08:55	07/12/2020 18:52	07/12/2020 08:55	07/12/2020 18:52	9,93	28	278,16	CHI
20201231872	ALOANDIA	PK12046026	GOIATUBA S1	07/12/2020 08:55	07/12/2020 18:52	07/12/2020 08:55	07/12/2020 18:52	9,93	1	9,93	CHI
20201231873	JATAI	JT21241751	JATAI S1	07/12/2020 08:55	07/12/2020 20:17	07/12/2020 08:55	07/12/2020 20:17	11,35	1	11,35	CHI
20201231877	CATALAO	10032546945	CATALAO S2	07/12/2020 08:56	07/12/2020 11:12	07/12/2020 08:56	07/12/2020 11:12	2,25	1	2,25	CHI
20201231887	ALEXANIA	AX21072490	ALEXANIA	07/12/2020 08:57	07/12/2020 15:28	07/12/2020 08:57	07/12/2020 15:28	6,51	2	13,02	CHI
20201231891	SILVANIA	SV21192067	VIANOPOLIS	07/12/2020 08:57	07/12/2020 11:35	07/12/2020 08:57	07/12/2020 11:35	2,62	1	2,62	CHI
20201231892	GOIANIA	17467561	MEIA PONTE	07/12/2020 08:58	07/12/2020 10:38	07/12/2020 08:58	07/12/2020 10:38	1,66	1	1,66	CHI
20201234759	JAUPACI	JP12395429	IPORA	07/12/2020 08:58	08/12/2020 13:05	07/12/2020 08:58	08/12/2020 13:05	28,11	3	84,34	CHI
20201231898	PIRES DO RIO	PR21159626	PIRES DO RIO S2	07/12/2020 08:59	07/12/2020 20:09	07/12/2020 08:59	07/12/2020 20:09	11,15	1	11,15	CHI
20201227232	CAIAPONIA	CP12060848	CAIAPONIA	07/12/2020 09:00	08/12/2020 10:19	07/12/2020 09:00	08/12/2020 10:19	25,31	12	303,75	CHI
20201231903	IPAMERI	IP12316540	PIRES DO RIO S2	07/12/2020 09:00	07/12/2020 11:59	07/12/2020 09:00	07/12/2020 11:59	2,97	1	2,97	CHI
20201231917	TRINDADE	40029116	TRINDADE	07/12/2020 09:02	07/12/2020 16:20	07/12/2020 09:02	07/12/2020 16:20	7,30	1	7,30	CHI
20201231923	FLORES DE GOIAS	FB12357919	FLORES DE GOIAS	07/12/2020 09:02	08/12/2020 08:18	07/12/2020 09:02	08/12/2020 08:18	23,25	36	837,17	CHI
20201231924	CALDAZINHA	LB12029877	DAIA S2	07/12/2020 09:02	07/12/2020 13:22	07/12/2020 09:02	07/12/2020 13:22	4,32	8	34,54	CHI
20201232986	MORRINHOS	MR12182966LD	MORRINHOS	07/12/2020 09:02	07/12/2020 13:03	07/12/2020 09:02	07/12/2020 13:03	4,01	14	56,12	CHI
20201231930	GUARINOS	GF21317997	SANTA TEREZINHA	07/12/2020 09:03	07/12/2020 10:47	07/12/2020 09:03	07/12/2020 10:47	1,73	1	1,73	CHI
20201231931	PROFESSOR JAMIL SAFADY	PJ21043090	ROCHEDO	07/12/2020 09:03	08/12/2020 17:17	07/12/2020 09:03	08/12/2020 17:17	32,23	1	32,23	CHI
20201231933	GOIANIA	10959488	GOIANIA LESTE S3	07/12/2020 09:03	07/12/2020 11:06	07/12/2020 09:03	07/12/2020 11:06	2,04	1	2,04	CHI
20201231940	AGUA FRIA DE GOIAS	TL21076116	SAO JOAO D ALIANCA	07/12/2020 09:04	07/12/2020 21:35	07/12/2020 09:04	07/12/2020 21:35	12,51	1	12,51	CHI
20201231952	GOIANIA	GN12162233	REAL S2	07/12/2020 09:05	07/12/2020 10:37	07/12/2020 09:05	07/12/2020 10:37	1,53	10	15,30	CHI
20201232707	VARJAO	GA12007522	GUAPO S1	07/12/2020 09:05	07/12/2020 11:56	07/12/2020 09:05	07/12/2020 11:56	2,85	6	17,10	CHI
20201232707	GUAPO	GA12007522	GUAPO S1	07/12/2020 09:05	07/12/2020 11:56	07/12/2020 09:05	07/12/2020 11:56	2,85	9	25,64	CHI
20201231960	FORMOSA	10028758224	ITUIQUIRA	07/12/2020 09:06	07/12/2020 14:11	07/12/2020 09:06	07/12/2020 14:11	5,08	1	5,08	CHI
20201231964	FAZENDA NOVA	FN21146335	BRITANIA	07/12/2020 09:06	07/12/2020 18:04	07/12/2020 09:06	07/12/2020 18:04	8,96	1	8,96	CHI
20201241286	MINACU	10032207113	MINACU	07/12/2020 09:06	08/12/2020 21:06	07/12/2020 09:06	08/12/2020 21:06	36,00	1	36,00	CHI
20201231969	PIRENOPOLIS	PV12366314	CORUMBA	07/12/2020 09:07	07/12/2020 23:53	07/12/2020 19:17	07/12/2020 23:49	4,54	4	18,16	CHI
20201231969	PIRENOPOLIS	PV21117883	CORUMBA	07/12/2020 09:07	07/12/2020 23:53	07/12/2020 09:07	07/12/2020 23:53	14,78	2	29,55	CHI
20201231970	ABADIANIA	AA12388795	DAIA S2	07/12/2020 09:07	07/12/2020 19:01	07/12/2020 09:07	07/12/2020 19:01	9,90	2	19,80	CHI
20201231973	ITARUMA	IM21033233	CACHOEIRA ALTA	07/12/2020 09:07	07/12/2020 11:06	07/12/2020 09:07	07/12/2020 11:06	1,98	2	3,95	CHI
20201231980	AMARALINA	LC12278479	MARA ROSA	07/12/2020 09:08	07/12/2020 16:43	07/12/2020 09:08	07/12/2020 16:43	7,58	1	7,58	CHI
20201231983	APARECIDA DE GOIANIA	10002992114	INDEPENDENCIA S2	07/12/2020 09:08	07/12/2020 13:18	07/12/2020 09:08	07/12/2020 13:18	4,15	1	4,15	CHI
20201231985	FORMOSA	10014696604	ITUIQUIRA	07/12/2020 09:08	07/12/2020 19:53	07/12/2020 09:08	07/12/2020 19:53	10,74	1	10,74	CHI
20201231986	PALMINOPOLIS	1340008571	PALMEIRAS	07/12/2020 09:08	07/12/2020 13:50	07/12/2020 09:08	07/12/2020 13:50	4,70	1	4,70	CHI
20201231992	PORANGATU	PO12265511	PORANGATU	07/12/2020 09:09	08/12/2020 13:00	07/12/2020 09:09	08/12/2020 13:00	27,85	1	27,85	CHI
20201231996	MORRINHOS	MR12223329	MORRINHOS	07/12/2020 09:09	07/12/2020 15:04	07/12/2020 09:09	07/12/2020 15:04	5,91	1	5,91	CHI
20201232002	APARECIDA DE GOIANIA	16281093	REAL S2	07/12/2020 09:10	07/12/2020 12:27	07/12/2020 09:10	07/12/2020 12:27	3,27	1	3,27	CHI
20201232007	BELA VISTA DE GOIAS	BV12000037	BELA VISTA S1	07/12/2020 09:11	07/12/2020 14:54	07/12/2020 09:11	07/12/2020 14:54	5,71	17	97,12	CHI
20201232008	PALESTINA DE GOIAS	PV21188282	PALESTINA	07/12/2020 09:11	07/12/2020 14:41	07/12/2020 09:11	07/12/2020 14:41	5,50	1	5,50	CHI
20201232011	SILVANIA	SV12078047	VIANOPOLIS	07/12/2020 09:11	07/12/2020 12:17	07/12/2020 09:11	07/12/2020 12:17	3,09	2	6,18	CHI
20201233614	MONTIVIDIU	MV12200186	MONTIVIDIU T	07/12/2020 09:11	07/12/2020 18:10	07/12/2020 09:11	07/12/2020 18:10	8,97	14	125,62	CHI
20201233614	CAIAPONIA	MV12200186	MONTIVIDIU T	07/12/2020 09:11	07/12/2020 18:10	07/12/2020 09:11	07/12/2020 18:10	8,97	6	53,84	CHI
20201232013	BELA VISTA DE GOIAS	BV31168945	BELA VISTA S1	07/12/2020 09:12	07/12/2020 16:59	07/12/2020 09:12	07/12/2020 16:59	7,78	1	7,78	CHI
20201232015	PIRACANJUBA	PJ12025032	PIRACANJUBA	07/12/2020 09:12	07/12/2020 13:55	07/12/2020 09:12	07/12/2020 13:55	4,70	1	4,70	CHI
20201232016	SANTO ANTONIO DO DESCOBERTO	SN12313924	MARAJOARA	07/12/2020 09:12	07/12/2020 15:15	07/12/2020 09:12	07/12/2020 15:15	6,03	5	30,17	CHI
20201232017	URUACU	UR12208588	URUACU	07/12/2020 09:13	07/12/2020 13:00	07/12/2020 09:13	07/12/2020 13:00	3,78	7	26,47	CHI
20201232028	NOVA CRIXAS	NA21220420	NOVA CRIXAS	07/12/2020 09:14	07/12/2020 11:03	07/12/2020 09:14	07/12/2020 11:03	1,82	1	1,82	CHI
20201232029	ACREUNA	EU21264501	ACREUNA	07/12/2020 09:14	07/12/2020 15:28	07/12/2020 09:14	07/12/2020 15:28	6,23	1	6,23	CHI
20201232030	AGUAS LINDAS DE GOIAS	4830441216	AGUAS LINDAS DE GOIAS S1	07/12/2020 09:14	07/12/2020 11:41	07/12/2020 09:14	07/12/2020 11:41	2,45	0	0,00	CHI
20201232032	NEROPOLIS	160040190	NEROPOLIS S2	07/12/2020 09:14	07/12/2020 15:36	07/12/2020 09:14	07/12/2020 15:36	6,36	1	6,36	CHI
20201232042	ALTO PARAISO DE GOIAS	BF11365269	SAO JOAO D ALIANCA	07/12/2020 09:15	08/12/2020 01:10	07/12/2020 09:15	08/12/2020 01:10	15,90	1	15,90	CHI

20201235485	PONTALINA	PK32045966	PONTALINA	07/12/2020 09:15	08/12/2020 09:08	07/12/2020 09:15	08/12/2020 09:08	23,88	2	47,76	CHI
20201232044	LUZIANIA	LZ12261445	MARAJÓARA	07/12/2020 09:16	07/12/2020 13:29	07/12/2020 09:16	07/12/2020 13:29	4,21	3	12,63	CHI
20201232048	FORMOSA	10005007559	ITUIQUIRA	07/12/2020 09:17	08/12/2020 14:54	07/12/2020 09:17	08/12/2020 14:54	29,62	1	29,62	CHI
20201232064	JUSSARA	JR21259887	JUSSARA	07/12/2020 09:18	08/12/2020 10:46	07/12/2020 09:18	08/12/2020 10:46	25,46	2	50,91	CHI
20201232065	JANDAIA	JD21221213	PALMEIRAS	07/12/2020 09:18	07/12/2020 20:26	07/12/2020 09:18	07/12/2020 20:26	11,12	1	11,12	CHI
20201232071	TRES RANCHOS	TH12057692	CATALAO S1	07/12/2020 09:20	07/12/2020 10:48	07/12/2020 09:20	07/12/2020 10:48	1,46	2	2,92	CHI
20201232082	CEZARINA	10031528080	CEZARINA	07/12/2020 09:21	07/12/2020 17:14	07/12/2020 09:21	07/12/2020 17:14	7,87	1	7,87	CHI
20201232083	ANAPOLIS	AN11000027	JUNDIAI S1	07/12/2020 09:21	07/12/2020 20:37	07/12/2020 09:21	07/12/2020 20:37	11,25	37	416,31	CHI
20201232085	ITARUMA	IM21271703	CACHOEIRA ALTA	07/12/2020 09:22	07/12/2020 12:25	07/12/2020 09:22	07/12/2020 12:25	3,04	2	6,08	CHI
20201233409	URUTAI	UT12016978RE	URUTAI	07/12/2020 09:22	07/12/2020 17:26	07/12/2020 09:22	07/12/2020 17:26	8,07	111	896,11	CHI
20201232091	NIQUELANDIA	NQ21348708	URUACU	07/12/2020 09:23	07/12/2020 16:22	07/12/2020 09:23	07/12/2020 16:22	6,97	1	6,97	CHI
20201232096	SANTA RITA DO NOVO DESTINO	DF21329110	BARRO ALTO	07/12/2020 09:23	07/12/2020 12:58	07/12/2020 09:23	07/12/2020 12:58	3,57	10	35,69	CHI
20201232102	SILVANIA	SV21248842	VIANOPOLIS	07/12/2020 09:24	07/12/2020 10:19	07/12/2020 09:24	07/12/2020 10:19	0,91	1	0,91	CHI
20201232113	NOVO GAMA	2900014135	MARAJÓARA	07/12/2020 09:26	07/12/2020 11:09	07/12/2020 09:26	07/12/2020 11:09	1,71	1	1,71	CHI
20201232114	IPORA	730141743	IPORA	07/12/2020 09:26	07/12/2020 18:16	07/12/2020 09:26	07/12/2020 18:16	8,83	1	8,83	CHI
20201232116	RIO VERDE	630081300	RIO VERDE S1	07/12/2020 09:26	07/12/2020 14:04	07/12/2020 09:26	07/12/2020 14:04	4,64	1	4,64	CHI
20201232132	GOIANIA	10023009770	GOIANIA LESTE S3	07/12/2020 09:28	07/12/2020 11:45	07/12/2020 09:28	07/12/2020 11:45	2,27	1	2,27	CHI
20201235854	PONTALINA	PK12041942	PONTALINA	07/12/2020 09:28	08/12/2020 10:59	07/12/2020 09:28	08/12/2020 10:59	25,52	5	127,58	CHI
20201232142	LEOPOLDO DE BULHOES	LB21252750	DAIA S2	07/12/2020 09:29	07/12/2020 16:48	07/12/2020 09:29	07/12/2020 16:48	7,30	1	7,30	CHI
20201232151	CUMARI	CY12203041	CATALAO S1	07/12/2020 09:31	08/12/2020 01:38	07/12/2020 09:31	08/12/2020 01:38	16,11	1	16,11	CHI
20201232154	PALMEIRAS DE GOIAS	PL12098934	PALMEIRAS	07/12/2020 09:31	07/12/2020 15:09	07/12/2020 09:31	07/12/2020 15:09	5,62	6	33,73	CHI
20201232157	PANAMA	GT12352675	GOIATUBA S1	07/12/2020 09:31	07/12/2020 17:23	07/12/2020 09:31	07/12/2020 17:23	7,85	2	15,70	CHI
20201232157	GOIATUBA	GT12352675	GOIATUBA S1	07/12/2020 09:31	07/12/2020 17:23	07/12/2020 09:31	07/12/2020 17:23	7,85	2	15,70	CHI
20201232883	LUZIANIA	LZ12304995	VIANOPOLIS	07/12/2020 09:31	07/12/2020 12:55	07/12/2020 09:31	07/12/2020 12:55	3,39	8	27,08	CHI
20201232883	ORIZONA	LZ12304995	VIANOPOLIS	07/12/2020 09:31	07/12/2020 12:55	07/12/2020 09:31	07/12/2020 12:55	3,39	86	291,13	CHI
20201232917	CORUMBAIBA	CI12280791	VILA CORUMBA	07/12/2020 09:31	07/12/2020 20:44	07/12/2020 09:31	07/12/2020 20:44	11,21	10	112,12	CHI
20201232160	GUARINOS	GF21280704	SANTA TEREZINHA	07/12/2020 09:32	07/12/2020 11:53	07/12/2020 09:32	07/12/2020 11:53	2,34	1	2,34	CHI
20201232163	PIRENOPOLIS	PV21227818	CORUMBA	07/12/2020 09:32	07/12/2020 23:30	07/12/2020 09:32	07/12/2020 23:30	13,95	1	13,95	CHI
20201232167	AGUA FRIA DE GOIAS	TL21151815	SAO JOAO D ALIANCA	07/12/2020 09:33	07/12/2020 14:21	07/12/2020 09:33	07/12/2020 14:21	4,80	1	4,80	CHI
20201232170	TRINDADE	40041591	TRINDADE	07/12/2020 09:33	07/12/2020 14:12	07/12/2020 09:33	07/12/2020 14:12	4,64	1	4,64	CHI
20201232222	FORMOSA	FA12218278	SAO JOAO D ALIANCA	07/12/2020 09:33	07/12/2020 17:37	07/12/2020 09:33	07/12/2020 17:37	8,05	3	24,16	CHI
20201232412	RIO VERDE	RV12260643	CABRIUVA S2	07/12/2020 09:33	07/12/2020 12:12	07/12/2020 09:33	07/12/2020 12:12	2,64	9	23,74	CHI
20201232180	FORMOSA	10001749887	ITUIQUIRA	07/12/2020 09:34	07/12/2020 13:14	07/12/2020 09:34	07/12/2020 13:14	3,66	1	3,66	CHI
20201232181	MINEIROS	MY12322341	PARQUE DAS EMAS	07/12/2020 09:34	07/12/2020 19:10	07/12/2020 13:02	07/12/2020 19:10	6,13	1	6,13	CHI
20201232190	MORRINHOS	MR21284228	MORRINHOS	07/12/2020 09:35	07/12/2020 17:26	07/12/2020 09:35	07/12/2020 17:26	7,84	1	7,84	CHI
20201232202	FORMOSA	10006256269	ITUIQUIRA	07/12/2020 09:36	08/12/2020 00:25	07/12/2020 09:36	08/12/2020 00:25	14,82	1	14,82	CHI
20201232204	CALDAS NOVAS	CN12213869	SERRA DE CALDAS	07/12/2020 09:36	07/12/2020 11:13	07/12/2020 09:36	07/12/2020 11:13	1,60	174	278,93	CHI
20201232205	ANAPOLIS	20207852	ANAPOLIS UNIVERSITARIO S2	07/12/2020 09:36	07/12/2020 13:50	07/12/2020 09:36	07/12/2020 13:50	4,22	1	4,22	CHI
20201232220	ANICUNS	AC21000079	ANICUNS	07/12/2020 09:38	07/12/2020 14:15	07/12/2020 09:38	07/12/2020 14:15	4,61	1	4,61	CHI
20201232225	ABADIANIA	AA21056385	ANAPOLIS UNIVERSITARIO S1	07/12/2020 09:38	07/12/2020 13:45	07/12/2020 09:38	07/12/2020 13:45	4,10	1	4,10	CHI
20201232226	PIRACANJUBA	PJ21033480	CRISTIANOPOLIS	07/12/2020 09:38	07/12/2020 19:34	07/12/2020 09:38	07/12/2020 19:34	9,92	1	9,92	CHI
20201232244	IPORA	IR11060708	IPORA	07/12/2020 09:38	07/12/2020 12:52	07/12/2020 10:15	07/12/2020 12:52	2,61	123	320,69	CHI
20201232235	SILVANIA	SV21137448	DAIA S2	07/12/2020 09:39	07/12/2020 15:19	07/12/2020 09:39	07/12/2020 15:19	5,65	2	11,30	CHI
20201232242	LUZIANIA	LZ11370813	RIO VERMELHO	07/12/2020 09:41	07/12/2020 13:48	07/12/2020 09:41	07/12/2020 13:48	4,12	1	4,12	CHI
20201232243	EDEIA	1120034910	EDEIA	07/12/2020 09:41	08/12/2020 04:00	07/12/2020 09:41	08/12/2020 04:00	18,33	1	18,33	CHI
20201232245	GOIANIA	14333600	CARAJAS S2	07/12/2020 09:41	07/12/2020 11:55	07/12/2020 09:41	07/12/2020 11:55	2,22	1	2,22	CHI
20201232252	CRIXAS	CX12342279	SERRA DO OURO	07/12/2020 09:42	07/12/2020 17:01	07/12/2020 09:42	07/12/2020 17:01	7,31	3	21,94	CHI
20201232253	RIO VERDE	RV21406015	CABRIUVA S2	07/12/2020 09:42	07/12/2020 18:20	07/12/2020 09:42	07/12/2020 18:20	8,63	2	17,26	CHI
20201232258	ANICUNS	910027870	ANICUNS	07/12/2020 09:43	07/12/2020 12:24	07/12/2020 09:43	07/12/2020 12:24	2,68	1	2,68	CHI
20201232266	GUARINOS	GF21185465	SANTA TEREZINHA	07/12/2020 09:44	07/12/2020 12:48	07/12/2020 09:44	07/12/2020 12:48	3,06	1	3,06	CHI
20201232308	QUIRINOPOLIS	QI21227702	QUIRINOPOLIS	07/12/2020 09:47	07/12/2020 13:10	07/12/2020 09:47	07/12/2020 13:10	3,37	1	3,37	CHI

20201232310	IVOLANDIA	1560010335	IPORA	07/12/2020 09:47	07/12/2020 18:41	07/12/2020 09:47	07/12/2020 18:41	8,89	1	8,89	CHI
20201232311	HIDROLANDIA	10002232870	ANHANGUERA	07/12/2020 09:48	07/12/2020 12:28	07/12/2020 09:48	07/12/2020 12:28	2,67	1	2,67	CHI
20201232318	CHROMINIA	HD12320395	PONTALINA	07/12/2020 09:48	07/12/2020 19:52	07/12/2020 09:48	07/12/2020 19:52	10,05	1	10,05	CHI
20201232318	HIDROLANDIA	HD12320395	PONTALINA	07/12/2020 09:48	07/12/2020 19:52	07/12/2020 09:48	07/12/2020 19:52	10,05	8	80,40	CHI
20201232368	PALMEIRAS DE GOIAS	PL12395109	PALMEIRAS	07/12/2020 09:49	07/12/2020 12:00	07/12/2020 09:49	07/12/2020 12:00	2,18	6	13,06	CHI
20201229881	SANTO ANTONIO DO DESCOBERTO	SN12389385	MARAJOARA	07/12/2020 09:50	07/12/2020 12:04	07/12/2020 09:50	07/12/2020 12:04	2,23	51	113,55	CHI
20201229881	DISTRITO FEDERAL	SN12389385	MARAJOARA	07/12/2020 09:50	07/12/2020 12:04	07/12/2020 09:50	07/12/2020 12:04	2,23	3	6,68	CHI
20201232328	VICENTINOPOLIS	VI21335234	VICENTINOPOLIS	07/12/2020 09:50	08/12/2020 12:20	07/12/2020 09:50	08/12/2020 12:20	26,50	1	26,50	CHI
20201232332	MINEIROS	MY12306477	PARQUE DAS EMAS	07/12/2020 09:50	07/12/2020 12:55	07/12/2020 09:50	07/12/2020 12:55	3,07	1	3,07	CHI
20201232334	BRITANIA	BT21010496	BRITANIA	07/12/2020 09:50	08/12/2020 08:55	07/12/2020 09:50	08/12/2020 08:55	23,08	1	23,08	CHI
20201232335	MORRO AGUDO DE GOIAS	MS12364729	ITAPURANGA	07/12/2020 09:50	07/12/2020 12:45	07/12/2020 09:50	07/12/2020 12:45	2,90	3	8,71	CHI
20201232514	MUNDO NOVO DE GOIAS	MH12269464	NOVA CRIXAS	07/12/2020 09:50	07/12/2020 12:58	07/12/2020 09:50	07/12/2020 12:58	3,13	37	115,74	CHI
20201232344	CRISTALINA	KR12199519	PAMPLONA	07/12/2020 09:52	07/12/2020 15:48	07/12/2020 09:52	07/12/2020 15:48	5,93	5	29,64	CHI
20201232345	PIRENOPOLIS	PV21318100	CORUMBA	07/12/2020 09:52	07/12/2020 12:55	07/12/2020 09:52	07/12/2020 12:55	3,04	1	3,04	CHI
20201232346	GOIANIRA	GR12066241LD	INHUMAS S1	07/12/2020 09:52	07/12/2020 16:25	07/12/2020 09:52	07/12/2020 16:25	6,54	2	13,08	CHI
20201232369	GOIATUBA	MR12041248	GOIATUBA S2	07/12/2020 09:53	07/12/2020 13:35	07/12/2020 09:53	07/12/2020 13:35	3,69	2	7,38	CHI
20201232369	BURITI ALEGRE	MR12041248	GOIATUBA S2	07/12/2020 09:53	07/12/2020 13:35	07/12/2020 09:53	07/12/2020 13:35	3,69	3	11,07	CHI
20201232355	ITAUUCU	110028569	INHUMAS S1	07/12/2020 09:54	07/12/2020 14:56	07/12/2020 09:54	07/12/2020 14:56	5,03	1	5,03	CHI
20201232359	SANCLERLANDIA	1210035367	FIRMINOPOLIS S2	07/12/2020 09:54	07/12/2020 17:12	07/12/2020 09:54	07/12/2020 17:12	7,30	1	7,30	CHI
20201232361	IVOLANDIA	IV12259453	IPORA	07/12/2020 09:54	08/12/2020 10:58	07/12/2020 09:54	08/12/2020 10:58	25,06	8	200,51	CHI
20201233389	IPAMERI	IP12107653	IPAMERI	07/12/2020 09:54	07/12/2020 17:01	07/12/2020 09:54	07/12/2020 17:01	7,11	91	647,29	CHI
20201233389	CORUMBAIBA	IP12107653	IPAMERI	07/12/2020 09:54	07/12/2020 17:01	07/12/2020 09:54	07/12/2020 17:01	7,11	3	21,34	CHI
20201233389	CALDAS NOVAS	IP12107653	IPAMERI	07/12/2020 09:54	07/12/2020 17:01	07/12/2020 09:54	07/12/2020 17:01	7,11	11	78,24	CHI
20201232379	ORIZONA	OZ12085009	PIRES DO RIO S2	07/12/2020 09:55	07/12/2020 12:50	07/12/2020 09:55	07/12/2020 12:50	2,91	6	17,47	CHI
20201232424	INHUMAS	O0800214	INHUMAS S2	07/12/2020 09:55	07/12/2020 10:03	07/12/2020 09:55	07/12/2020 10:03	0,14	10913	1546,01	CHI
20201232424	CATURAI	O0800214	INHUMAS S2	07/12/2020 09:55	07/12/2020 10:03	07/12/2020 09:55	07/12/2020 10:03	0,14	1	0,14	CHI
20201232424	GOIANIRA	O0800214	INHUMAS S2	07/12/2020 09:55	07/12/2020 10:03	07/12/2020 09:55	07/12/2020 10:03	0,14	11	1,56	CHI
20201232424	BRAZABRANTES	O0800214	INHUMAS S2	07/12/2020 09:55	07/12/2020 10:03	07/12/2020 09:55	07/12/2020 10:03	0,14	41	5,81	CHI
20201232966	PORANGATU	PO21038749	PORANGATU	07/12/2020 09:55	07/12/2020 11:51	07/12/2020 09:55	07/12/2020 11:51	1,92	1	1,92	CHI
20201232371	JATAI	JT21063284	JATAI S3	07/12/2020 09:57	07/12/2020 23:05	07/12/2020 09:57	07/12/2020 23:05	13,13	1	13,13	CHI
20201232383	CRIXAS	CX21082438	SERRA DO OURO	07/12/2020 09:58	07/12/2020 19:29	07/12/2020 09:58	07/12/2020 19:29	9,51	2	19,02	CHI
20201232384	PIRENOPOLIS	PV21171301	CORUMBA	07/12/2020 09:58	07/12/2020 22:45	07/12/2020 09:58	07/12/2020 22:45	12,77	1	12,77	CHI
20201232385	CACU	CC21037333	CACHOEIRA ALTA	07/12/2020 09:58	07/12/2020 20:45	07/12/2020 09:58	07/12/2020 20:45	10,77	1	10,77	CHI
20201232386	SAO LUIS DE MONTES BELOS	SL32154604	SAO LUIZ DOS MONTES BELOS	07/12/2020 09:58	07/12/2020 18:30	07/12/2020 09:58	07/12/2020 18:30	8,52	2	17,05	CHI
20201232387	SANTO ANTONIO DO DESCOBERTO	SN12037170	MARAJOARA	07/12/2020 09:58	07/12/2020 22:36	07/12/2020 09:58	07/12/2020 22:36	12,62	39	492,25	CHI
20201232389	ACREUNA	EU11301646	ACREUNA	07/12/2020 09:58	07/12/2020 19:01	07/12/2020 09:58	07/12/2020 19:01	9,04	52	469,95	CHI
20201232394	LUZIANIA	LZ21153646	VIANOPOLIS	07/12/2020 09:58	07/12/2020 14:48	07/12/2020 09:58	07/12/2020 14:48	4,82	1	4,82	CHI
20201233226	PLANALTIMA	PI12355771	PLANALTIMA	07/12/2020 09:58	07/12/2020 17:21	07/12/2020 09:58	07/12/2020 17:21	7,37	7	51,60	CHI
20201233473	FORMOSA	FA11322765	ITUIQUIRA	07/12/2020 09:58	07/12/2020 18:57	07/12/2020 09:58	07/12/2020 18:57	8,97	88	789,34	CHI
20201232396	JESUPOLIS	JE21264086	SAO FRANCISCO DE GOIAS	07/12/2020 09:59	08/12/2020 00:41	07/12/2020 09:59	08/12/2020 00:16	14,28	1	14,28	CHI
20201232396	JESUPOLIS	JE13382876	SAO FRANCISCO DE GOIAS	07/12/2020 09:59	08/12/2020 00:41	07/12/2020 21:40	08/12/2020 00:41	3,01	6	18,08	CHI
20201232396	PETROLINA DE GOIAS	JE13382876	SAO FRANCISCO DE GOIAS	07/12/2020 09:59	08/12/2020 00:41	07/12/2020 21:40	08/12/2020 00:41	3,01	1	3,01	CHI
20201232403	FAZENDA NOVA	FN12183426	IPORA	07/12/2020 09:59	07/12/2020 13:18	07/12/2020 09:59	07/12/2020 13:18	3,31	9	29,78	CHI
20201232409	RIO VERDE	630539571	RIO VERDE S1	07/12/2020 09:59	07/12/2020 12:34	07/12/2020 09:59	07/12/2020 12:34	2,57	1	2,57	CHI
20201232704	MARA ROSA	MQ12262723	MARA ROSA	07/12/2020 09:59	07/12/2020 17:24	07/12/2020 09:59	07/12/2020 17:24	7,41	2	14,83	CHI
20201233297	IVOLANDIA	IV12165764	IPORA	07/12/2020 09:59	08/12/2020 09:43	07/12/2020 09:59	08/12/2020 09:43	23,73	5	118,66	CHI
20201233297	PARAUNA	IV12165764	IPORA	07/12/2020 09:59	08/12/2020 09:43	07/12/2020 09:59	08/12/2020 09:43	23,73	1	23,73	CHI
20201232415	GOIANIA	10892734	GOIANIA LESTE S2	07/12/2020 10:01	07/12/2020 10:54	07/12/2020 10:01	07/12/2020 10:54	0,88	1	0,88	CHI
20201232418	SANTA CRUZ DE GOIAS	BC12012519	PIRES DO RIO S2	07/12/2020 10:01	07/12/2020 20:07	07/12/2020 10:01	07/12/2020 20:07	10,09	2	20,18	CHI
20201232421	ANAPOLIS	20243467	JUNDIAI S2	07/12/2020 10:01	07/12/2020 14:55	07/12/2020 10:01	07/12/2020 14:55	4,89	1	4,89	CHI
20201232423	TRINDADE	TR12000031	TRINDADE	07/12/2020 10:02	07/12/2020 17:24	07/12/2020 10:02	07/12/2020 17:24	7,38	1	7,38	CHI

20201232426	SILVANIA	SV21144152	DAIA S2	07/12/2020 10:02	07/12/2020 12:09	07/12/2020 10:02	07/12/2020 12:09	2,11	1	2,11	CHI
20201232429	APARECIDA DE GOIANIA	14482642	REAL S1	07/12/2020 10:02	07/12/2020 11:20	07/12/2020 10:02	07/12/2020 11:20	1,29	1	1,29	CHI
20201232434	GOIANAPOLIS	GP21059091	DAIA S2	07/12/2020 10:03	07/12/2020 14:11	07/12/2020 10:03	07/12/2020 14:11	4,13	2	8,26	CHI
20201232437	FORMOSA	610194860	ITUIQUIRA	07/12/2020 10:03	08/12/2020 10:09	07/12/2020 10:03	08/12/2020 10:09	24,11	1	24,11	CHI
20201232438	MINACU	IH12320901	MINACU	07/12/2020 10:03	07/12/2020 22:54	07/12/2020 10:03	07/12/2020 22:54	12,84	5	64,22	CHI
20201235164	IPAMERI	OZ12137542RE	PIRES DO RIO S2	07/12/2020 10:03	07/12/2020 22:59	07/12/2020 10:03	07/12/2020 22:59	12,93	10	129,31	CHI
20201235649	COLINAS DO SUL	10016968466	NIQUELANDIA SUBTRANSMISSAO	07/12/2020 10:03	08/12/2020 08:39	07/12/2020 10:03	08/12/2020 08:39	22,60	1	22,60	CHI
20201232444	CAVALCANTE	TI12232369RE	MINACU	07/12/2020 10:04	07/12/2020 15:55	07/12/2020 10:04	07/12/2020 15:55	5,84	3	17,53	CHI
20201232444	COLINAS DO SUL	TI12232369RE	MINACU	07/12/2020 10:04	07/12/2020 15:55	07/12/2020 10:04	07/12/2020 15:55	5,84	14	81,82	CHI
20201232445	GOIAS	GS11188166	GOIAS	07/12/2020 10:04	07/12/2020 14:50	07/12/2020 10:04	07/12/2020 14:50	4,76	2	9,52	CHI
20201232449	JATAI	290234311	JATAI S3	07/12/2020 10:04	07/12/2020 17:26	07/12/2020 10:04	07/12/2020 17:26	7,35	1	7,35	CHI
20201232453	BOM JESUS DE GOIAS	BJ12068972	BOM JESUS DE GOIAS	07/12/2020 10:05	08/12/2020 15:56	07/12/2020 10:05	08/12/2020 15:56	29,84	2	59,68	CHI
20201232457	ARAGOIANA	AO12221194	INDEPENDENCIA S2	07/12/2020 10:05	07/12/2020 17:20	07/12/2020 10:05	07/12/2020 14:26	4,34	3	13,01	CHI
20201232457	ARAGOIANA	7861552	INDEPENDENCIA S2	07/12/2020 10:05	07/12/2020 17:20	07/12/2020 10:05	07/12/2020 17:20	7,24	9	65,13	CHI
20201233342	SANTA TEREZINHA DE GOIAS	SG12202098RE	SANTA TEREZINHA	07/12/2020 10:06	07/12/2020 15:58	07/12/2020 10:06	07/12/2020 15:58	5,85	138	807,95	CHI
20201233342	UIRAPURU	SG12202098RE	SANTA TEREZINHA	07/12/2020 10:06	07/12/2020 15:58	07/12/2020 10:06	07/12/2020 15:58	5,85	60	351,28	CHI
20201233342	CAMPOS VERDES	SG12202098RE	SANTA TEREZINHA	07/12/2020 10:06	07/12/2020 15:58	07/12/2020 10:06	07/12/2020 15:58	5,85	40	234,19	CHI
20201232481	SAO LUIS DE MONTES BELOS	10015233012	FIRMINOPOLIS S2	07/12/2020 10:07	07/12/2020 20:24	07/12/2020 10:07	07/12/2020 20:24	10,27	1	10,27	CHI
20201232482	PALMEIRAS DE GOIAS	PL12000043	PALMEIRAS	07/12/2020 10:07	07/12/2020 11:14	07/12/2020 10:07	07/12/2020 11:14	1,11	1	1,11	CHI
20201232485	PIRACANJUBA	PJ21432337	BELA VISTA S1	07/12/2020 10:08	07/12/2020 15:13	07/12/2020 10:08	07/12/2020 15:13	5,08	1	5,08	CHI
20201232487	APORE	AE12000051	ITAJA S1	07/12/2020 10:08	07/12/2020 14:39	07/12/2020 10:08	07/12/2020 14:39	4,51	7	31,55	CHI
20201232513	CAIAPONIA	CP12355605	PALESTINA	07/12/2020 10:09	08/12/2020 11:03	07/12/2020 10:09	08/12/2020 11:03	24,89	7	174,24	CHI
20201232501	MORRINHOS	MR21160378	MORRINHOS	07/12/2020 10:10	07/12/2020 20:49	07/12/2020 10:10	07/12/2020 20:49	10,65	1	10,65	CHI
20201232503	QUIRINOPOLIS	QI21207138	QUIRINOPOLIS	07/12/2020 10:10	07/12/2020 11:41	07/12/2020 10:10	07/12/2020 11:41	1,51	1	1,51	CHI
20201233574	CORUMBAIBA	CI12120756RE	VILA CORUMBA	07/12/2020 10:10	07/12/2020 18:34	07/12/2020 10:10	07/12/2020 18:34	8,39	48	402,83	CHI
20201232509	MORRINHOS	MR12265945	MORRINHOS	07/12/2020 10:11	07/12/2020 18:44	07/12/2020 10:11	07/12/2020 18:44	8,55	2	17,10	CHI
20201232510	CALDAS NOVAS	CN21298655	CALDAS NOVAS S2	07/12/2020 10:11	07/12/2020 12:38	07/12/2020 10:11	07/12/2020 12:38	2,45	1	2,45	CHI
20201232715	OUIDOR	IO12085096	CATALAO S1	07/12/2020 10:11	07/12/2020 16:16	07/12/2020 10:11	07/12/2020 16:16	6,09	2	12,18	CHI
20201232715	TRES RANCHOS	IO12085096	CATALAO S1	07/12/2020 10:11	07/12/2020 16:16	07/12/2020 10:11	07/12/2020 16:16	6,09	4	24,35	CHI
20201232715	DAVINOPOLIS	IO12085096	CATALAO S1	07/12/2020 10:11	07/12/2020 16:16	07/12/2020 10:11	07/12/2020 16:16	6,09	7	42,61	CHI
20201232516	JATAI	290338580	JATAI S2	07/12/2020 10:12	08/12/2020 08:14	07/12/2020 10:12	08/12/2020 08:14	22,03	1	22,03	CHI
20201232517	NOVA CRIXAS	NA12154611	MOZARLANDIA	07/12/2020 10:12	07/12/2020 22:58	07/12/2020 10:12	07/12/2020 22:58	12,76	1	12,76	CHI
20201232523	CAMPOS BELOS	820001144	SAO DOMINGOS	07/12/2020 10:12	07/12/2020 17:04	07/12/2020 10:12	07/12/2020 17:04	6,85	1	6,85	CHI
20201232526	CATALAO	CT21192557	CATALAO S1	07/12/2020 10:13	07/12/2020 12:11	07/12/2020 10:13	07/12/2020 12:11	1,96	1	1,96	CHI
20201232532	IACIARA	10006328715	IACIARA S1	07/12/2020 10:13	07/12/2020 13:58	07/12/2020 10:13	07/12/2020 13:58	3,74	1	3,74	CHI
20201232546	ORIZONA	OZ12300906	PIRES DO RIO S2	07/12/2020 10:13	07/12/2020 18:20	07/12/2020 10:13	07/12/2020 18:20	8,11	7	56,77	CHI
20201232535	MINEIROS	MY21123136	PARQUE DAS EMAS	07/12/2020 10:14	07/12/2020 15:35	07/12/2020 10:14	07/12/2020 15:35	5,35	1	5,35	CHI
20201235856	PONTALINA	PK12083350	PONTALINA	07/12/2020 10:14	08/12/2020 09:28	07/12/2020 10:14	08/12/2020 09:28	23,23	7	162,62	CHI
20201233813	SAO JOAO D ALIANCA	JL12342390	SAO JOAO D ALIANCA	07/12/2020 10:15	07/12/2020 16:07	07/12/2020 10:15	07/12/2020 16:07	5,86	1	5,86	CHI
20201232554	IPORA	730017710	IPORA	07/12/2020 10:16	08/12/2020 12:14	07/12/2020 10:16	08/12/2020 12:14	25,96	1	25,96	CHI
20201232565	GOIANIRA	390035798	GOIANIRA	07/12/2020 10:17	07/12/2020 18:41	07/12/2020 10:17	07/12/2020 18:41	8,39	1	8,39	CHI
20201232570	RIO VERDE	RV21361132	RIO VERDE S1	07/12/2020 10:18	07/12/2020 11:35	07/12/2020 10:18	07/12/2020 11:35	1,28	1	1,28	CHI
20201232572	ANAPOLIS	AN11130801	JUNDIAI S2	07/12/2020 10:18	07/12/2020 11:32	07/12/2020 10:18	07/12/2020 11:32	1,23	126	154,45	CHI
20201232576	APARECIDA DE GOIANIA	10001844103	REAL S1	07/12/2020 10:18	07/12/2020 11:40	07/12/2020 10:18	07/12/2020 11:40	1,35	1	1,35	CHI
20201232581	BOM JARDIM DE GOIAS	BM21123533	BOM JARDIM	07/12/2020 10:19	07/12/2020 14:40	07/12/2020 10:19	07/12/2020 14:40	4,35	1	4,35	CHI
20201232586	BELA VISTA DE GOIAS	BV21037740	BELA VISTA S1	07/12/2020 10:19	07/12/2020 17:27	07/12/2020 10:19	07/12/2020 17:27	7,13	1	7,13	CHI
20201232981	SANTA HELENA DE GOIAS	SH12279545	IPEGUARI	07/12/2020 10:19	07/12/2020 23:30	07/12/2020 10:19	07/12/2020 23:30	13,18	15	197,65	CHI
20201232595	SAO JOAO D ALIANCA	JL12151205	SAO JOAO D ALIANCA	07/12/2020 10:20	07/12/2020 16:45	07/12/2020 10:20	07/12/2020 16:45	6,41	1	6,41	CHI
20201232602	ITUMBIARA	IT12273866	ITUMBIARA VELHA S1	07/12/2020 10:21	07/12/2020 18:45	07/12/2020 10:21	07/12/2020 18:45	8,40	9	75,64	CHI
20201232606	ANAPOLIS	AN12353412	JUNDIAI S1	07/12/2020 10:21	07/12/2020 13:12	07/12/2020 10:21	07/12/2020 13:12	2,84	15	42,63	CHI
20201232619	ARAGARCAS	10020912542	ARAGARCAS	07/12/2020 10:22	08/12/2020 08:05	07/12/2020 10:22	08/12/2020 08:05	21,70	1	21,70	CHI

20201231191	ARAGOIANIA	AO11216857	GUAPO S2	07/12/2020 10:23	07/12/2020 17:03	07/12/2020 10:23	07/12/2020 17:03	6,65	33	219,55	CHI
20201232621	IACIARA	IA21194981	IACIARA S2	07/12/2020 10:23	07/12/2020 13:13	07/12/2020 10:23	07/12/2020 13:13	2,83	2	5,66	CHI
20201232624	RIO VERDE	RV21073781	QUIRINOPOLIS	07/12/2020 10:23	07/12/2020 15:48	07/12/2020 10:23	07/12/2020 15:48	5,41	1	5,41	CHI
20201232633	PLANALTINA	PI21379542	SAO JOAO D ALIANCA	07/12/2020 10:24	07/12/2020 20:56	07/12/2020 10:24	07/12/2020 20:56	10,53	1	10,53	CHI
20201232639	APORE	AE12303831LD	ITAJA S1	07/12/2020 10:24	07/12/2020 17:12	07/12/2020 10:24	07/12/2020 17:12	6,80	1	6,80	CHI
20201232641	NIQUELANDIA	NQ12056788	URUACU	07/12/2020 10:25	07/12/2020 15:27	07/12/2020 10:25	07/12/2020 15:27	5,03	94	473,00	CHI
20201232642	LUZIANIA	LZ21183980	RIO VERMELHO	07/12/2020 10:25	07/12/2020 18:05	07/12/2020 10:25	07/12/2020 18:05	7,66	2	15,32	CHI
20201232655	ITUMBIARA	IT21122275	ITUMBIARA NOVA	07/12/2020 10:25	08/12/2020 09:08	07/12/2020 10:25	08/12/2020 09:08	22,70	1	22,70	CHI
20201232861	VIANOPOLIS	VN12037574	VIANOPOLIS	07/12/2020 10:25	07/12/2020 14:00	07/12/2020 10:25	07/12/2020 14:00	3,59	12	43,08	CHI
20201232660	MONTIVIDIU	MV21207747	MONTIVIDIU T	07/12/2020 10:26	07/12/2020 22:50	07/12/2020 10:26	07/12/2020 22:50	12,39	1	12,39	CHI
20201232661	APARECIDA DE GOIANIA	10005263261	INDEPENDENCIA S2	07/12/2020 10:26	07/12/2020 11:17	07/12/2020 10:26	07/12/2020 11:17	0,84	1	0,84	CHI
20201232667	TRINDADE	40130964	TRINDADE	07/12/2020 10:27	08/12/2020 02:50	07/12/2020 10:27	08/12/2020 02:50	16,38	1	16,38	CHI
20201232668	EDEIA	EA12028579	VICENTINOPOLIS	07/12/2020 10:27	07/12/2020 15:09	07/12/2020 10:27	07/12/2020 15:09	4,69	1	4,69	CHI
20201232669	MOZARLANDIA	410005850	MOZARLANDIA	07/12/2020 10:27	07/12/2020 18:01	07/12/2020 10:27	07/12/2020 18:01	7,56	1	7,56	CHI
20201232688	TRINDADE	TR11035140	TRINDADE	07/12/2020 10:27	08/12/2020 00:42	07/12/2020 19:03	08/12/2020 00:42	5,65	61	344,75	CHI
20201232674	CATALAO	CT21152868	IPAMERI	07/12/2020 10:28	07/12/2020 17:51	07/12/2020 10:28	07/12/2020 17:51	7,38	1	7,38	CHI
20201232689	TRINDADE	40046217	TRINDADE	07/12/2020 10:29	07/12/2020 16:14	07/12/2020 10:29	07/12/2020 16:14	5,75	1	5,75	CHI
20201232705	NEROPOLIS	10022195325	NEROPOLIS S2	07/12/2020 10:30	07/12/2020 17:17	07/12/2020 10:30	07/12/2020 17:17	6,77	1	6,77	CHI
20201232706	AURILANDIA	AI21342972	FIRMINOPOLIS S2	07/12/2020 10:30	08/12/2020 07:42	07/12/2020 10:30	08/12/2020 07:42	21,19	1	21,19	CHI
20201233537	NOVA VENEZA	NV12000109	INHUMAS S1	07/12/2020 10:31	07/12/2020 14:04	07/12/2020 10:31	07/12/2020 14:04	3,54	809	2862,51	CHI
20201233922	PARAUNA	PU12336650	ACREUNA	07/12/2020 10:32	07/12/2020 17:20	07/12/2020 10:32	07/12/2020 17:20	6,79	2	13,57	CHI
20201232721	CRISTALINA	KR21357812	PAMPLONA	07/12/2020 10:33	07/12/2020 20:15	07/12/2020 10:33	07/12/2020 20:15	9,70	1	9,70	CHI
20201232732	JARAGUA	JA21116896	JARAGUA	07/12/2020 10:34	07/12/2020 21:39	07/12/2020 10:34	07/12/2020 21:39	11,07	1	11,07	CHI
20201232737	CRISTALINA	KR21403556	CRISTALINA S2	07/12/2020 10:35	07/12/2020 20:35	07/12/2020 10:35	07/12/2020 20:35	9,99	1	9,99	CHI
20201232740	NIQUELANDIA	NQ21281638	BARRO ALTO	07/12/2020 10:35	07/12/2020 17:30	07/12/2020 10:35	07/12/2020 17:30	6,90	1	6,90	CHI
20201232743	GOIANIA	12330978	GOIANIA LESTE S2	07/12/2020 10:36	07/12/2020 11:59	07/12/2020 10:36	07/12/2020 11:59	1,38	1	1,38	CHI
20201233583	PIRENOPOLIS	PV12381257	CORUMBA	07/12/2020 10:36	07/12/2020 16:07	07/12/2020 10:36	07/12/2020 16:07	5,51	131	721,34	CHI
20201232748	CRIXAS	CX11399932	RUBIATABA	07/12/2020 10:37	07/12/2020 13:12	07/12/2020 10:37	07/12/2020 13:12	2,58	1	2,58	CHI
20201232750	GOIANIA	10003533334	CARAJAS S2	07/12/2020 10:37	07/12/2020 13:43	07/12/2020 10:37	07/12/2020 13:43	3,10	1	3,10	CHI
20201232753	RIO VERDE	RV21202814	CABRIUVA S1	07/12/2020 10:37	07/12/2020 14:16	07/12/2020 10:37	07/12/2020 14:16	3,64	2	7,29	CHI
20201232755	RIO VERDE	RV12327004	RIO VERDE S2	07/12/2020 10:37	07/12/2020 13:32	07/12/2020 10:37	07/12/2020 13:32	2,92	2	5,84	CHI
20201232756	PADRE BERNARDO	PB11330468	PADRE BERNARDO	07/12/2020 10:37	07/12/2020 13:37	07/12/2020 10:37	07/12/2020 13:37	2,99	60	179,37	CHI
20201234339	MAIRIPOTABA	MI11108114	PONTALINA	07/12/2020 10:37	07/12/2020 19:38	07/12/2020 10:37	07/12/2020 19:38	9,00	48	432,15	CHI
20201232760	CAMPO ALEGRE DE GOIAS	CM21166731	CAMPO ALEGRE DE GOIAS	07/12/2020 10:38	07/12/2020 12:14	07/12/2020 10:38	07/12/2020 12:14	1,60	1	1,60	CHI
20201232764	RIO VERDE	630456914	RIO VERDE S1	07/12/2020 10:38	07/12/2020 23:12	07/12/2020 10:38	07/12/2020 23:12	12,55	1	12,55	CHI
20201234862	COLINAS DO SUL	TI12256389	NIQUELANDIA SUBTRANSMISSAO	07/12/2020 10:39	08/12/2020 01:12	07/12/2020 10:39	08/12/2020 01:12	14,53	1	14,53	CHI
20201234862	NIQUELANDIA	TI12256389	NIQUELANDIA SUBTRANSMISSAO	07/12/2020 10:39	08/12/2020 01:12	07/12/2020 10:39	08/12/2020 01:12	14,53	4	58,14	CHI
20201232772	VILA PROPICIO	NP21339385	GOIANESIA S1	07/12/2020 10:40	07/12/2020 23:14	07/12/2020 10:40	07/12/2020 23:14	12,57	1	12,57	CHI
20201232773	PORANGATU	PO11227204	PORANGATU	07/12/2020 10:40	07/12/2020 13:51	07/12/2020 10:40	07/12/2020 13:51	3,18	1	3,18	CHI
20201232775	QUIRINOPOLIS	QI11014265	QUIRINOPOLIS	07/12/2020 10:40	07/12/2020 15:43	07/12/2020 10:40	07/12/2020 15:43	5,05	108	545,16	CHI
20201232786	JATAI	JT12347805	MONTIVIDIU T	07/12/2020 10:41	07/12/2020 14:19	07/12/2020 10:41	07/12/2020 14:19	3,62	1	3,62	CHI
20201232788	RIO VERDE	RV21305857	RIO VERDE S2	07/12/2020 10:42	07/12/2020 17:14	07/12/2020 10:42	07/12/2020 17:14	6,53	8	52,26	CHI
20201232798	IVOLANDIA	IV21165834	IPORA	07/12/2020 10:42	08/12/2020 15:54	07/12/2020 10:42	08/12/2020 15:54	29,19	1	29,19	CHI
20201232798	APARECIDA DE GOIANIA	10022793680	ATLANTICO S3	07/12/2020 10:43	07/12/2020 11:07	07/12/2020 10:43	07/12/2020 11:07	0,39	1	0,39	CHI
20201232799	CACHOEIRA ALTA	CA21163366	CACHOEIRA ALTA	07/12/2020 10:43	07/12/2020 15:08	07/12/2020 10:43	07/12/2020 15:08	4,40	1	4,40	CHI
20201232802	CRISTALINA	KR21171564	CRISTALINA S2	07/12/2020 10:44	07/12/2020 21:13	07/12/2020 10:44	07/12/2020 21:13	10,48	2	20,96	CHI
20201232803	NOVA ROMA	ND21327507	IACIARA S2	07/12/2020 10:44	07/12/2020 21:59	07/12/2020 10:44	07/12/2020 21:59	11,24	2	22,48	CHI
20201232805	MORRINHOS	10031330736	MORRINHOS	07/12/2020 10:44	07/12/2020 14:03	07/12/2020 10:44	07/12/2020 14:03	3,31	1	3,31	CHI
20201232959	SANTO ANTONIO DO DESCOBERTO	SN21268727	AGUAS LINDAS DE GOIAS S2	07/12/2020 10:44	07/12/2020 12:00	07/12/2020 10:44	07/12/2020 12:00	1,27	75	94,98	CHI
20201232809	JARAGUA	JA21302218	CORUMBA	07/12/2020 10:45	07/12/2020 16:13	07/12/2020 10:45	07/12/2020 16:13	5,46	1	5,46	CHI
20201232811	ALEXANIA	AX21312000	ALEXANIA	07/12/2020 10:45	07/12/2020 16:01	07/12/2020 10:45	07/12/2020 16:01	5,26	1	5,26	CHI

20201232813	AGUAS LINDAS DE GOIAS	10000752027	AGUAS LINDAS DE GOIAS S1	07/12/2020 10:45	07/12/2020 12:25	07/12/2020 10:45	07/12/2020 12:25	1,66	1	1,66	CHI
20201232828	GOIANIA	10494522	GOIANIA LESTE S3	07/12/2020 10:48	07/12/2020 12:34	07/12/2020 10:48	07/12/2020 12:34	1,76	1	1,76	CHI
20201232832	QUIRINOPOLIS	QI32052485	QUIRINOPOLIS	07/12/2020 10:49	07/12/2020 14:29	07/12/2020 10:49	07/12/2020 14:29	3,67	7	25,66	CHI
20201232835	VILA PROPICIO	NP21239007	BARRO ALTO	07/12/2020 10:49	08/12/2020 00:25	07/12/2020 10:49	08/12/2020 00:25	13,60	1	13,60	CHI
20201232842	CARMO DO RIO VERDE	IK21275449	ITAPURANGA	07/12/2020 10:50	07/12/2020 17:27	07/12/2020 10:50	07/12/2020 17:27	6,61	1	6,61	CHI
20201232845	JATAI	290156750	JATAI S3	07/12/2020 10:50	07/12/2020 22:47	07/12/2020 10:50	07/12/2020 22:47	11,94	1	11,94	CHI
20201232846	CAMPOS BELOS	CH21265887	SAO DOMINGOS	07/12/2020 10:50	07/12/2020 12:20	07/12/2020 10:50	07/12/2020 12:20	1,49	1	1,49	CHI
20201232852	GOIANDIRA	GD12127589	CATALAO S1	07/12/2020 10:51	07/12/2020 15:53	07/12/2020 10:51	07/12/2020 15:53	5,02	1	5,02	CHI
20201232855	CAMPO ALEGRE DE GOIAS	CM21166762	CAMPO ALEGRE DE GOIAS	07/12/2020 10:52	07/12/2020 13:29	07/12/2020 10:52	07/12/2020 13:29	2,61	1	2,61	CHI
20201232860	MINEIROS	MY12195611	PARQUE DAS EMAS	07/12/2020 10:54	07/12/2020 20:32	07/12/2020 10:54	07/12/2020 20:32	9,63	6	57,77	CHI
20201232864	FORMOSA	610034935	ITUIQUIRA	07/12/2020 10:54	08/12/2020 11:57	07/12/2020 10:54	08/12/2020 11:57	25,05	1	25,05	CHI
20201232866	TRES RANCHOS	2170015985	CATALAO S1	07/12/2020 10:55	07/12/2020 15:17	07/12/2020 10:55	07/12/2020 15:17	4,37	1	4,37	CHI
20201232868	CAMPOS BELOS	CH12211504	SAO DOMINGOS	07/12/2020 10:55	07/12/2020 13:58	07/12/2020 10:55	07/12/2020 13:58	3,05	5	15,23	CHI
20201232870	LUZIANIA	3200094938	MARAJOARA	07/12/2020 10:55	07/12/2020 15:37	07/12/2020 10:55	07/12/2020 15:37	4,69	1	4,69	CHI
20201232871	LUZIANIA	LZ21153856	CRISTALINA S2	07/12/2020 10:55	07/12/2020 15:34	07/12/2020 10:55	07/12/2020 15:34	4,64	2	9,28	CHI
20201232881	QUIRINOPOLIS	80091313	QUIRINOPOLIS	07/12/2020 10:56	07/12/2020 14:51	07/12/2020 10:56	07/12/2020 14:51	3,90	1	3,90	CHI
20201233406	TRINDADE	GC12000274	GUAPO S1	07/12/2020 10:56	08/12/2020 10:14	07/12/2020 10:56	07/12/2020 14:18	3,36	1	3,36	CHI
20201233406	TRINDADE	GC12000274	GUAPO S1	07/12/2020 10:56	08/12/2020 10:14	07/12/2020 10:56	08/12/2020 08:42	21,77	1	21,77	CHI
20201233406	GUAPO	GC12000274	GUAPO S1	07/12/2020 10:56	08/12/2020 10:14	07/12/2020 10:56	08/12/2020 08:57	22,01	41	902,54	CHI
20201233406	TRINDADE	GC12000274	GUAPO S1	07/12/2020 10:56	08/12/2020 10:14	07/12/2020 10:56	08/12/2020 08:57	22,01	16	352,21	CHI
20201233406	TRINDADE	GC12000274	GUAPO S1	07/12/2020 10:56	08/12/2020 10:14	07/12/2020 10:56	08/12/2020 09:15	22,32	14	312,44	CHI
20201233406	TRINDADE	GC12000274	GUAPO S1	07/12/2020 10:56	08/12/2020 10:14	07/12/2020 14:19	08/12/2020 09:15	18,94	1	18,94	CHI
20201233406	TRINDADE	GC12000274	GUAPO S1	07/12/2020 10:56	08/12/2020 10:14	07/12/2020 10:56	08/12/2020 10:14	23,31	3	69,92	CHI
20201232885	GOIANIA	10133070	FERROVIARIO S2	07/12/2020 10:57	07/12/2020 12:44	07/12/2020 10:57	07/12/2020 12:44	1,78	1	1,78	CHI
20201232886	URUACU	640026084	URUACU	07/12/2020 10:57	07/12/2020 21:03	07/12/2020 10:57	07/12/2020 21:03	10,10	1	10,10	CHI
20201232890	GOIANIA	16037637	MEIA PONTE	07/12/2020 10:58	07/12/2020 14:36	07/12/2020 10:58	07/12/2020 14:36	3,63	1	3,63	CHI
20201235151	ANAPOLIS	AN11380250	ANAPOLIS UNIVERSITARIO S2	07/12/2020 10:58	07/12/2020 22:37	07/12/2020 10:58	07/12/2020 22:37	11,64	80	930,84	CHI
20201232905	RIO VERDE	RV21230940	MONTIVIDIU T	07/12/2020 10:59	07/12/2020 22:16	07/12/2020 10:59	07/12/2020 22:16	11,27	1	11,27	CHI
20201232935	GOIANIA	GN11144363	CAMPINAS S2	07/12/2020 11:02	07/12/2020 12:39	07/12/2020 11:02	07/12/2020 12:39	1,61	58	93,59	CHI
20201232934	OUVIDOR	10031038970	CATALAO S1	07/12/2020 11:04	07/12/2020 16:58	07/12/2020 11:04	07/12/2020 16:58	5,90	1	5,90	CHI
20201232941	FIRMINOPOLIS	FR12061397	FIRMINOPOLIS S1	07/12/2020 11:04	08/12/2020 09:55	07/12/2020 11:04	08/12/2020 09:55	22,84	1	22,84	CHI
20201232942	QUIRINOPOLIS	QI12296643	QUIRINOPOLIS	07/12/2020 11:04	07/12/2020 18:29	07/12/2020 11:04	07/12/2020 18:29	7,41	6	44,45	CHI
20201234797	SERRANOPOLIS	SX12390581	JATAI S1	07/12/2020 11:04	07/12/2020 22:08	07/12/2020 11:04	07/12/2020 22:08	11,07	6	66,39	CHI
20201232946	EDEIA	EA11048360	EDEIA	07/12/2020 11:05	07/12/2020 13:20	07/12/2020 11:05	07/12/2020 13:20	2,25	138	309,92	CHI
20201232948	CATALAO	CT21231783	CATALAO S1	07/12/2020 11:05	07/12/2020 16:41	07/12/2020 11:05	07/12/2020 16:41	5,60	1	5,60	CHI
20201232958	NOVO GAMA	2460026270	PACAEMBU S1	07/12/2020 11:05	07/12/2020 15:45	07/12/2020 11:05	07/12/2020 15:45	4,65	1	4,65	CHI
20201232961	PLANALTINA	PI21155423	SAO JOAO D ALIANCA	07/12/2020 11:06	07/12/2020 18:53	07/12/2020 11:06	07/12/2020 18:53	7,78	1	7,78	CHI
20201232965	ANAPOLIS	AN11351100	ANAPOLIS UNIVERSITARIO S2	07/12/2020 11:06	07/12/2020 16:19	07/12/2020 11:06	07/12/2020 16:19	5,20	143	744,28	CHI
20201232970	CACU	CC21219241	CACHOEIRA ALTA	07/12/2020 11:07	07/12/2020 14:26	07/12/2020 11:07	07/12/2020 14:26	3,30	1	3,30	CHI
20201232974	ANAPOLIS	20740979	JUNDIAI S1	07/12/2020 11:08	07/12/2020 13:13	07/12/2020 11:08	07/12/2020 13:13	2,07	1	2,07	CHI
20201232975	LEOPOLDO DE BULHOES	LB12202372	DAIA S2	07/12/2020 11:09	07/12/2020 16:21	07/12/2020 11:09	07/12/2020 16:21	5,19	26	134,99	CHI
20201232979	GOUVELANDIA	GB21126426	QUIRINOPOLIS	07/12/2020 11:09	07/12/2020 15:34	07/12/2020 11:09	07/12/2020 15:34	4,40	1	4,40	CHI
20201232982	GOIANIA	16026846	XAVANTES	07/12/2020 11:10	07/12/2020 13:16	07/12/2020 11:10	07/12/2020 13:16	2,09	1	2,09	CHI
20201232983	ABADIANIA	AA12261204	ANAPOLIS UNIVERSITARIO S1	07/12/2020 11:10	08/12/2020 02:55	07/12/2020 11:10	08/12/2020 02:55	15,74	24	377,75	CHI
20201232984	SAO JOAO D ALIANCA	JL21244135	SAO JOAO D ALIANCA	07/12/2020 11:10	07/12/2020 14:06	07/12/2020 11:10	07/12/2020 14:06	2,92	2	5,84	CHI
20201233101	SANTA HELENA DE GOIAS	SH11023994	IPEGUARI	07/12/2020 11:10	07/12/2020 20:06	07/12/2020 11:10	07/12/2020 20:06	8,93	143	1276,79	CHI
20201232987	APARECIDA DE GOIANIA	10008182920	INDEPENDENCIA S1	07/12/2020 11:11	07/12/2020 12:28	07/12/2020 11:11	07/12/2020 12:28	1,28	1	1,28	CHI
20201232994	GOIANIA	17268084	ATLANTICO S1	07/12/2020 11:12	07/12/2020 13:00	07/12/2020 11:12	07/12/2020 13:00	1,79	1	1,79	CHI
20201233207	CORUMBAIBA	CI12391490	VILA CORUMBA	07/12/2020 11:12	07/12/2020 15:02	07/12/2020 11:12	07/12/2020 15:02	3,82	37	141,47	CHI
20201232998	GAMELEIRA DE GOIAS	SV31090458	ANAPOLIS UNIVERSITARIO S2	07/12/2020 11:13	07/12/2020 14:41	07/12/2020 11:13	07/12/2020 14:41	3,47	3	10,40	CHI
20201233002	GUAPO	GA21320436	GUAPO S1	07/12/2020 11:13	07/12/2020 14:00	07/12/2020 11:13	07/12/2020 14:00	2,77	2	5,54	CHI

20201233005	LUZIANIA	LZ21351305	RIO VERMELHO	07/12/2020 11:14	07/12/2020 18:42	07/12/2020 11:14	07/12/2020 18:42	7,47	1	7,47	CHI
20201233015	MAIRIPOTABA	MI12049512	PONTALINA	07/12/2020 11:15	08/12/2020 08:31	07/12/2020 11:15	08/12/2020 08:31	21,26	5	106,30	CHI
20201233016	FORMOSA	FA12206227	ITUIQUIRA	07/12/2020 11:15	08/12/2020 14:18	07/12/2020 11:15	08/12/2020 14:18	27,04	26	703,13	CHI
20201233017	CRIXAS	CX21190014	SANTA TEREZINHA	07/12/2020 11:15	07/12/2020 17:28	07/12/2020 11:15	07/12/2020 17:28	6,20	1	6,20	CHI
20201233018	IPORA	IR21060669	ARENOPOLIS	07/12/2020 11:15	07/12/2020 17:32	07/12/2020 11:15	07/12/2020 17:32	6,27	1	6,27	CHI
20201233028	AURILANDIA	1010002421	FIRMINOPOLIS S2	07/12/2020 11:17	08/12/2020 09:22	07/12/2020 11:17	08/12/2020 09:22	22,07	1	22,07	CHI
20201233038	CAVALCANTE	CJ12278451	NIQUELANDIA SUBTRANSMISSAO	07/12/2020 11:17	07/12/2020 20:05	07/12/2020 11:17	07/12/2020 20:05	8,80	28	246,37	CHI
20201233174	BALIZA	BH12358780	BOM JARDIM	07/12/2020 11:17	07/12/2020 17:04	07/12/2020 11:17	07/12/2020 17:04	5,77	16	92,35	CHI
20201233035	PARAUNA	PU12060610	FIRMINOPOLIS S2	07/12/2020 11:19	08/12/2020 10:25	07/12/2020 11:19	08/12/2020 10:25	23,09	1	23,09	CHI
20201233052	PLANALTINA	PI21400951	PLANALTINA	07/12/2020 11:22	07/12/2020 14:31	07/12/2020 11:22	07/12/2020 14:31	3,14	2	6,27	CHI
20201233465	JARAGUA	JA12221348	JARAGUA	07/12/2020 11:22	07/12/2020 19:13	07/12/2020 11:22	07/12/2020 19:13	7,84	7	54,87	CHI
20201233053	GOIANESIA	GE11215134	GOIANESIA S2	07/12/2020 11:23	07/12/2020 12:59	07/12/2020 11:23	07/12/2020 12:59	1,60	79	126,25	CHI
20201233058	FORMOSA	10003794189	ITUIQUIRA	07/12/2020 11:23	07/12/2020 21:01	07/12/2020 11:23	07/12/2020 21:01	9,62	1	9,62	CHI
20201234303	NOVA VENEZA	NV12272456	INHUMAS S1	07/12/2020 11:23	07/12/2020 16:45	07/12/2020 11:23	07/12/2020 16:45	5,36	10	53,60	CHI
20201233060	MATRINCHA	MP12171758	MATRINCHA	07/12/2020 11:24	08/12/2020 15:11	07/12/2020 11:24	08/12/2020 15:11	27,78	1	27,78	CHI
20201233061	BELA VISTA DE GOIAS	BV11000112	CEPAIGO S2	07/12/2020 11:24	07/12/2020 14:32	07/12/2020 11:24	07/12/2020 14:32	3,13	10	31,29	CHI
20201233068	GOIANIA	13779382	GOIANIA LESTE S1	07/12/2020 11:26	07/12/2020 14:54	07/12/2020 11:26	07/12/2020 14:54	3,45	1	3,45	CHI
20201233075	MORRO AGUDO DE GOIAS	MS12239817	ITAPURANGA	07/12/2020 11:28	07/12/2020 17:09	07/12/2020 11:28	07/12/2020 17:09	5,68	3	17,03	CHI
20201233076	CRISTALINA	KR21159939	PAMPLONA	07/12/2020 11:28	07/12/2020 13:20	07/12/2020 11:28	07/12/2020 13:20	1,86	1	1,86	CHI
20201233080	CROMINIA	CQ21025416	ROCHEDO	07/12/2020 11:29	07/12/2020 21:46	07/12/2020 11:29	07/12/2020 21:46	10,28	1	10,28	CHI
20201233083	APARECIDA DE GOIANIA	AP21000057	CEPAIGO S1	07/12/2020 11:30	07/12/2020 15:53	07/12/2020 11:30	07/12/2020 15:53	4,38	1	4,38	CHI
20201233086	ANICUNS	AV21193592	ANICUNS	07/12/2020 11:30	07/12/2020 16:40	07/12/2020 11:30	07/12/2020 16:40	5,15	1	5,15	CHI
20201235319	RUBIATABA	IW12267445	RUBIATABA	07/12/2020 11:30	08/12/2020 09:03	07/12/2020 11:30	08/12/2020 09:03	21,54	1	21,54	CHI
20201235319	ITAPACI	IW12267445	RUBIATABA	07/12/2020 11:30	08/12/2020 09:03	07/12/2020 11:30	08/12/2020 09:03	21,54	7	150,79	CHI
20201233087	MORRINHOS	MR21011820	MORRINHOS	07/12/2020 11:31	07/12/2020 20:43	07/12/2020 11:31	07/12/2020 20:43	9,20	2	18,40	CHI
20201233097	JATAI	10021705419	JATAI S2	07/12/2020 11:34	08/12/2020 12:02	07/12/2020 11:34	08/12/2020 12:02	24,47	1	24,47	CHI
20201233103	LUZIANIA	LZ21000443	MARAJOARA	07/12/2020 11:35	07/12/2020 21:07	07/12/2020 11:35	07/12/2020 21:07	9,53	1	9,53	CHI
20201233113	RIO VERDE	630187691	CABRIUVA S1	07/12/2020 11:36	07/12/2020 21:50	07/12/2020 11:36	07/12/2020 21:50	10,22	1	10,22	CHI
20201233863	CATALAO	CT12149164RE	CATALAO S1	07/12/2020 11:36	07/12/2020 17:13	07/12/2020 11:36	07/12/2020 17:13	5,61	147	825,00	CHI
20201233117	CATALAO	CT21130165	CATALAO S1	07/12/2020 11:37	07/12/2020 21:08	07/12/2020 11:37	07/12/2020 21:08	9,50	1	9,50	CHI
20201233127	ITAJA	IJ21154809	ITAJA S2	07/12/2020 11:39	07/12/2020 14:37	07/12/2020 11:39	07/12/2020 14:37	2,97	1	2,97	CHI
20201233132	NIQUELANDIA	NQ21333942	URUACU	07/12/2020 11:40	07/12/2020 18:06	07/12/2020 11:40	07/12/2020 18:06	6,42	1	6,42	CHI
20201233139	MINACU	IH21182333	MINACU	07/12/2020 11:41	07/12/2020 20:09	07/12/2020 11:41	07/12/2020 20:09	8,46	1	8,46	CHI
20201233142	VALPARAISO DE GOIAS	10016694773	MARAJOARA	07/12/2020 11:42	07/12/2020 16:01	07/12/2020 11:42	07/12/2020 16:01	4,32	1	4,32	CHI
20201233267	GOIANDIRA	GD12131094	CATALAO S1	07/12/2020 11:42	07/12/2020 17:54	07/12/2020 11:42	07/12/2020 17:54	6,19	7	43,36	CHI
20201233267	NOVA AURORA	GD12131094	CATALAO S1	07/12/2020 11:42	07/12/2020 17:54	07/12/2020 11:42	07/12/2020 17:54	6,19	2	12,39	CHI
20201233150	CHAPADAO DO CEU	DJ12153959	CHAPADAO DO CEU	07/12/2020 11:43	08/12/2020 09:50	08/12/2020 08:03	08/12/2020 09:35	1,53	6	9,20	CHI
20201233150	CHAPADAO DO CEU	DJ21336990	CHAPADAO DO CEU	07/12/2020 11:43	08/12/2020 09:50	07/12/2020 11:43	08/12/2020 09:50	22,12	1	22,12	CHI
20201233172	ITAPURANGA	IK21023681	ITAPURANGA	07/12/2020 11:44	07/12/2020 15:45	07/12/2020 11:44	07/12/2020 15:45	4,01	1	4,01	CHI
20201233178	APARECIDA DE GOIANIA	200671856	ANHANGUERA	07/12/2020 11:44	07/12/2020 13:24	07/12/2020 11:44	07/12/2020 13:24	1,65	1	1,65	CHI
20201234799	ITUMBIARA	IT12304246	ITUMBIARA NOVA	07/12/2020 11:44	07/12/2020 22:01	07/12/2020 11:44	07/12/2020 22:01	10,29	2	20,58	CHI
20201233184	PORANGATU	PO12262596	PORANGATU	07/12/2020 11:45	07/12/2020 15:19	07/12/2020 11:45	07/12/2020 15:19	3,56	38	135,43	CHI
20201233185	CALDAS NOVAS	CN21226659	CALDAS NOVAS S1	07/12/2020 11:45	07/12/2020 14:02	07/12/2020 11:45	07/12/2020 14:02	2,28	1	2,28	CHI
20201233188	TRINDADE	TR21283137	TRINDADE	07/12/2020 11:45	07/12/2020 13:23	07/12/2020 11:45	07/12/2020 13:23	1,62	1	1,62	CHI
20201233192	HIDROLANDIA	HD31047733	CEPAIGO S2	07/12/2020 11:46	07/12/2020 15:16	07/12/2020 11:46	07/12/2020 15:16	3,49	1	3,49	CHI
20201233198	GOIANIA	GN11132319	REAL S2	07/12/2020 11:46	07/12/2020 14:01	07/12/2020 13:29	07/12/2020 14:01	0,53	106	56,56	CHI
20201233455	GOIANIA	GN11000953	CAMPINAS S1	07/12/2020 11:46	07/12/2020 14:22	07/12/2020 11:46	07/12/2020 14:22	2,59	175	453,59	CHI
20201234093	SAO LUIZ DO NORTE	SZ12115033	BARRO ALTO	07/12/2020 11:46	07/12/2020 18:53	07/12/2020 11:46	07/12/2020 18:53	7,11	9	64,03	CHI
20201234093	HIDROLINA	SZ12115033	BARRO ALTO	07/12/2020 11:46	07/12/2020 18:53	07/12/2020 11:46	07/12/2020 18:53	7,11	1	7,11	CHI
20201234705	RIO QUENTE	CN12263786	RIO QUENTE	07/12/2020 11:47	07/12/2020 19:40	07/12/2020 11:47	07/12/2020 19:40	7,88	1	7,88	CHI
20201234705	CALDAS NOVAS	CN12263786	RIO QUENTE	07/12/2020 11:47	07/12/2020 19:40	07/12/2020 11:47	07/12/2020 19:40	7,88	35	275,64	CHI

20201234324	MINEIROS	PW12374393	PARQUE DAS EMAS	07/12/2020 11:48	07/12/2020 21:58	07/12/2020 11:48	07/12/2020 21:58	10,18	4	40,72	CHI
20201233220	SAO JOAO D ALIANCA	JL21292294	SAO JOAO D ALIANCA	07/12/2020 11:50	07/12/2020 17:41	07/12/2020 11:50	07/12/2020 17:41	5,84	1	5,84	CHI
20201233244	IPAMERI	IP12266897	IPAMERI	07/12/2020 11:51	07/12/2020 18:33	07/12/2020 11:51	07/12/2020 18:33	6,70	6	40,20	CHI
20201233669	FLORES DE GOIAS	FB12421836	FLORES DE GOIAS	07/12/2020 11:53	07/12/2020 16:46	07/12/2020 11:53	07/12/2020 16:46	4,88	25	121,90	CHI
20201233251	MAURILANDIA	1040029507	RIO DOS BOIS	07/12/2020 11:54	07/12/2020 19:06	07/12/2020 11:54	07/12/2020 19:06	7,19	1	7,19	CHI
20201233252	ARUANA	10024621593	ARUANA	07/12/2020 11:54	07/12/2020 15:16	07/12/2020 11:54	07/12/2020 15:16	3,36	1	3,36	CHI
20201233255	ALEXANIA	AX21190667	ALEXANIA	07/12/2020 11:55	07/12/2020 22:41	07/12/2020 11:55	07/12/2020 22:41	10,76	2	21,52	CHI
20201233263	SAO JOAO D ALIANCA	JL21208787	SAO JOAO D ALIANCA	07/12/2020 11:56	07/12/2020 16:24	07/12/2020 11:56	07/12/2020 16:24	4,45	4	17,82	CHI
20201233273	MAURILANDIA	1040002034	RIO DOS BOIS	07/12/2020 11:58	07/12/2020 16:24	07/12/2020 11:58	07/12/2020 16:24	4,42	1	4,42	CHI
20201233275	ITABERAI	IB12300318	ITABERAI S2	07/12/2020 11:58	07/12/2020 13:10	07/12/2020 11:58	07/12/2020 13:10	1,18	1	1,18	CHI
20201233280	VALPARAISO DE GOIAS	10008629011	PACAEMBU S2	07/12/2020 11:59	07/12/2020 12:49	07/12/2020 11:59	07/12/2020 12:49	0,82	1	0,82	CHI
20201233281	GOIANIA	11265796	AEROPORTO S1	07/12/2020 11:59	07/12/2020 15:19	07/12/2020 11:59	07/12/2020 15:19	3,32	1	3,32	CHI
20201233282	GOIAS	90038666	GOIAS	07/12/2020 11:59	07/12/2020 15:50	07/12/2020 11:59	07/12/2020 15:50	3,83	1	3,83	CHI
20201233285	GOIANIRA	GR21097065	INHUMAS S1	07/12/2020 12:00	07/12/2020 15:32	07/12/2020 12:00	07/12/2020 15:32	3,52	1	3,52	CHI
20201233286	TAQUARAL DE GOIAS	TQ21110681	ITABERAI S1	07/12/2020 12:00	07/12/2020 16:14	07/12/2020 12:00	07/12/2020 16:14	4,22	1	4,22	CHI
20201233288	MAURILANDIA	1040003658	RIO DOS BOIS	07/12/2020 12:00	07/12/2020 16:07	07/12/2020 12:00	07/12/2020 16:07	4,10	1	4,10	CHI
20201233289	HIDROLANDIA	HD21000172	CEPAIGO S2	07/12/2020 12:00	07/12/2020 14:39	07/12/2020 12:00	07/12/2020 14:39	2,64	1	2,64	CHI
20201233291	NIQUELANDIA	NQ21232492	BARRO ALTO	07/12/2020 12:01	07/12/2020 18:35	07/12/2020 12:01	07/12/2020 18:35	6,56	1	6,56	CHI
20201233745	LUZIANIA	LZ12153291	VIANOPOLIS	07/12/2020 12:01	07/12/2020 16:15	07/12/2020 12:01	07/12/2020 16:15	4,22	39	164,48	CHI
20201233302	LUZIANIA	LZ11253448	VIANOPOLIS	07/12/2020 12:03	07/12/2020 13:43	07/12/2020 12:03	07/12/2020 13:43	1,66	1	1,66	CHI
20201233307	SENADOR CANEDO	SW11188848	SENADOR CANEDO	07/12/2020 12:04	07/12/2020 13:11	07/12/2020 12:04	07/12/2020 13:11	1,11	193	213,59	CHI
20201233313	ITABERAI	10031269204	ITABERAI S2	07/12/2020 12:05	07/12/2020 15:48	07/12/2020 12:05	07/12/2020 15:48	3,72	1	3,72	CHI
20201233316	PONTALINA	PK21047336	VICENTINOPOLIS	07/12/2020 12:05	07/12/2020 17:54	07/12/2020 12:05	07/12/2020 17:54	5,80	1	5,80	CHI
20201233318	SENADOR CANEDO	SW11323293	SENADOR CANEDO	07/12/2020 12:06	07/12/2020 13:57	07/12/2020 12:06	07/12/2020 13:57	1,83	169	309,97	CHI
20201233319	CAMPINACU	5700012150	PORANGATU	07/12/2020 12:07	07/12/2020 14:13	07/12/2020 12:07	07/12/2020 14:13	2,10	1	2,10	CHI
20201233320	ALOANDIA	AD21199486	GOIATUBA S1	07/12/2020 12:07	07/12/2020 17:11	07/12/2020 12:07	07/12/2020 17:11	5,06	2	10,12	CHI
20201233322	ITAPURANGA	IK21333090	ITAPURANGA	07/12/2020 12:07	07/12/2020 13:32	07/12/2020 12:07	07/12/2020 13:32	1,41	1	1,41	CHI
20201233327	SAO MIGUEL DO ARAGUAIA	830046550	SAO MIGUEL DO ARAGUAIA	07/12/2020 12:09	07/12/2020 14:51	07/12/2020 12:09	07/12/2020 14:51	2,71	1	2,71	CHI
20201233334	JATAI	290107880	JATAI S3	07/12/2020 12:10	07/12/2020 18:26	07/12/2020 12:10	07/12/2020 18:26	6,27	1	6,27	CHI
20201233337	JATAI	290337460	JATAI S2	07/12/2020 12:12	07/12/2020 15:32	07/12/2020 12:12	07/12/2020 15:32	3,33	1	3,33	CHI
20201233345	VILA PROPICIO	550114403	GOIANESIA S1	07/12/2020 12:14	07/12/2020 20:11	07/12/2020 12:14	07/12/2020 20:11	7,94	1	7,94	CHI
20201233410	CORUMBAIBA	CI12263856	VILA CORUMBA	07/12/2020 12:14	07/12/2020 16:50	07/12/2020 12:14	07/12/2020 16:50	4,58	76	348,38	CHI
20201233410	NOVA AURORA	CI12263856	VILA CORUMBA	07/12/2020 12:14	07/12/2020 16:50	07/12/2020 12:14	07/12/2020 16:50	4,58	7	32,09	CHI
20201233610	IPAMERI	IP12099726	PIRES DO RIO S2	07/12/2020 12:14	08/12/2020 09:54	07/12/2020 12:14	08/12/2020 09:54	21,66	8	173,29	CHI
20201234167	FAINA	FC12147802	GOIAS	07/12/2020 12:14	07/12/2020 18:55	07/12/2020 12:14	07/12/2020 18:55	6,68	13	86,85	CHI
20201233351	PONTALINA	210030811	PONTALINA	07/12/2020 12:15	07/12/2020 22:17	07/12/2020 12:15	07/12/2020 22:17	10,03	1	10,03	CHI
20201230467	PORTEIRAO	ML10407216	RIO DOS BOIS	07/12/2020 12:16	07/12/2020 13:17	07/12/2020 12:16	07/12/2020 13:17	1,03	7	7,18	CHI
20201230467	GOIAS	ML10407216	RIO DOS BOIS	07/12/2020 12:16	07/12/2020 13:17	07/12/2020 12:16	07/12/2020 13:17	1,03	1	1,03	CHI
20201230467	QUIRINOPOLIS	ML10407216	RIO DOS BOIS	07/12/2020 12:16	07/12/2020 13:17	07/12/2020 12:16	07/12/2020 13:17	1,03	42	43,10	CHI
20201230467	BOM JESUS DE GOIAS	ML10407216	RIO DOS BOIS	07/12/2020 12:16	07/12/2020 13:17	07/12/2020 12:16	07/12/2020 13:17	1,03	21	21,55	CHI
20201230467	CASTELANDIA	ML10407216	RIO DOS BOIS	07/12/2020 12:16	07/12/2020 13:17	07/12/2020 12:16	07/12/2020 13:17	1,03	1599	1640,75	CHI
20201230467	MAURILANDIA	ML13226276	RIO DOS BOIS	07/12/2020 12:16	07/12/2020 13:17	07/12/2020 12:16	07/12/2020 13:17	1,03	13	13,34	CHI
20201230467	CASTELANDIA	ML13226276	RIO DOS BOIS	07/12/2020 12:16	07/12/2020 13:17	07/12/2020 12:16	07/12/2020 13:17	1,03	2	2,05	CHI
20201230467	GOIATUBA	ML10407216	RIO DOS BOIS	07/12/2020 12:16	07/12/2020 13:17	07/12/2020 12:16	07/12/2020 13:17	1,03	21	21,55	CHI
20201230467	MAURILANDIA	ML10407216	RIO DOS BOIS	07/12/2020 12:16	07/12/2020 13:17	07/12/2020 12:16	07/12/2020 13:17	1,03	2	2,05	CHI
20201233356	HIDROLANDIA	HD21010529	CEPAIGO S2	07/12/2020 12:16	08/12/2020 09:58	07/12/2020 12:16	08/12/2020 09:58	21,69	1	21,69	CHI
20201233361	COCALZINHO DE GOIAS	ZN12345320	AGUAS LINDAS DE GOIAS S2	07/12/2020 12:16	08/12/2020 11:30	07/12/2020 12:16	08/12/2020 11:30	23,22	1	23,22	CHI
20201233374	SAO LUIZ DO NORTE	SZ12066081	ITAPACI	07/12/2020 12:16	07/12/2020 17:40	07/12/2020 12:16	07/12/2020 17:40	5,40	7	37,78	CHI
20201233362	MINACU	IH11182312	MINACU	07/12/2020 12:17	07/12/2020 22:23	07/12/2020 12:17	07/12/2020 22:23	10,10	1	10,10	CHI
20201233363	SANTO ANTONIO DO DESCOBERTO	2210158728	AGUAS LINDAS DE GOIAS S2	07/12/2020 12:17	07/12/2020 15:41	07/12/2020 12:17	07/12/2020 15:41	3,39	1	3,39	CHI
20201233367	PALMEIRAS DE GOIAS	PL21186314	PALMEIRAS	07/12/2020 12:18	07/12/2020 13:11	07/12/2020 12:18	07/12/2020 13:11	0,88	1	0,88	CHI

20201233371	URUACU	CR11201694	CAMPINORTE	07/12/2020 12:19	07/12/2020 14:45	07/12/2020 12:19	07/12/2020 14:45	2,43	6	14,58	CHI
20201234994	JATAI	JT12234396	JATAI S1	07/12/2020 12:20	08/12/2020 00:03	07/12/2020 12:20	08/12/2020 00:03	11,71	9	105,39	CHI
20201233383	MORRINHOS	10018920428	MORRINHOS	07/12/2020 12:21	07/12/2020 19:21	07/12/2020 12:21	07/12/2020 19:21	7,00	1	7,00	CHI
20201233386	PADRE BERNARDO	10023493591	PADRE BERNARDO	07/12/2020 12:21	07/12/2020 15:34	07/12/2020 12:21	07/12/2020 15:34	3,21	1	3,21	CHI
20201233392	FIRMINOPOLIS	FR21118706	FIRMINOPOLIS S1	07/12/2020 12:22	08/12/2020 09:02	07/12/2020 12:22	08/12/2020 09:02	20,65	1	20,65	CHI
20201233505	MINEIROS	MY12360756	PARQUE DAS EMAS	07/12/2020 12:22	07/12/2020 15:09	07/12/2020 12:22	07/12/2020 15:09	2,78	2	5,55	CHI
20201233408	NIQUELANDIA	NQ211440175	SAO JOAO D ALIANCA	07/12/2020 12:26	07/12/2020 21:15	07/12/2020 12:26	07/12/2020 21:15	8,80	1	8,80	CHI
20201234315	JARAGUA	JA12298054	JARAGUA	07/12/2020 12:27	08/12/2020 11:02	07/12/2020 12:27	08/12/2020 11:02	22,57	5	112,87	CHI
20201233419	CRISTALINA	KR21406236	CRISTALINA S1	07/12/2020 12:28	07/12/2020 19:57	07/12/2020 12:28	07/12/2020 19:57	7,47	2	14,94	CHI
20201233421	BURITI DE GOIAS	BS21308354	FIRMINOPOLIS S2	07/12/2020 12:29	07/12/2020 19:47	07/12/2020 12:29	07/12/2020 19:47	7,30	1	7,30	CHI
20201233422	APARECIDA DE GOIANIA	10016090843	REAL S1	07/12/2020 12:29	07/12/2020 15:32	07/12/2020 12:29	07/12/2020 15:32	3,05	1	3,05	CHI
20201233425	CRISTALINA	KR21152357	PAMPLONA	07/12/2020 12:29	07/12/2020 18:28	07/12/2020 12:29	07/12/2020 18:28	5,97	1	5,97	CHI
20201233427	GOIANIA	GN12291338	ATLANTICO S2	07/12/2020 12:29	07/12/2020 14:46	07/12/2020 12:29	07/12/2020 14:46	2,27	32	72,60	CHI
20201233429	PARAUNA	JD12008607LD	PALMEIRAS	07/12/2020 12:30	07/12/2020 18:16	07/12/2020 12:30	07/12/2020 18:16	5,76	6	34,58	CHI
20201233429	JANDAIA	JD12008607LD	PALMEIRAS	07/12/2020 12:30	07/12/2020 18:16	07/12/2020 12:30	07/12/2020 18:16	5,76	81	466,79	CHI
20201233430	PORANGATU	PO12321004	PORANGATU	07/12/2020 12:31	07/12/2020 14:41	07/12/2020 12:31	07/12/2020 14:41	2,16	1	2,16	CHI
20201233431	SILVANIA	SV21157292	VIANOPOLIS	07/12/2020 12:31	07/12/2020 16:07	07/12/2020 12:31	07/12/2020 16:07	3,59	1	3,59	CHI
20201233433	GOIANIA	15969472	AEROPORTO S1	07/12/2020 12:32	07/12/2020 17:08	07/12/2020 12:32	07/12/2020 17:08	4,60	1	4,60	CHI
20201233434	GOIATUBA	GT21052924	GOIATUBA S1	07/12/2020 12:32	07/12/2020 22:41	07/12/2020 12:32	07/12/2020 22:41	10,15	1	10,15	CHI
20201233446	FORMOSA	610333768	ITUIQUIRA	07/12/2020 12:32	07/12/2020 21:38	07/12/2020 12:32	07/12/2020 21:38	9,09	1	9,09	CHI
20201233447	AGUA FRIA DE GOIAS	TL21342372	SAO JOAO D ALIANCA	07/12/2020 12:32	07/12/2020 19:46	07/12/2020 12:32	07/12/2020 19:46	7,22	1	7,22	CHI
20201236011	PONTALINA	PK21109440	PONTALINA	07/12/2020 12:33	08/12/2020 08:19	07/12/2020 12:33	08/12/2020 08:19	19,76	1	19,76	CHI
20201233466	UIRAPURU	UP12321930	SANTA TEREZINHA	07/12/2020 12:36	07/12/2020 14:24	07/12/2020 12:36	07/12/2020 14:24	1,80	3	5,39	CHI
20201233467	ANAPOLIS	20437043	ANAPOLIS UNIVERSITARIO S2	07/12/2020 12:36	07/12/2020 15:39	07/12/2020 12:36	07/12/2020 15:39	3,04	1	3,04	CHI
20201233468	ISRAELANDIA	IS21299244	IPORA	07/12/2020 12:36	07/12/2020 16:44	07/12/2020 12:36	07/12/2020 16:44	4,13	1	4,13	CHI
20201233495	GOIAS	90059591	GOIAS	07/12/2020 12:40	07/12/2020 15:58	07/12/2020 12:40	07/12/2020 15:58	3,29	1	3,29	CHI
20201233502	URUACU	10028967109	URUACU	07/12/2020 12:41	07/12/2020 20:53	07/12/2020 12:41	07/12/2020 20:53	8,20	1	8,20	CHI
20201233503	INACIOLANDIA	2810017615	QUIRINOPOLIS	07/12/2020 12:41	07/12/2020 16:36	07/12/2020 12:41	07/12/2020 16:36	3,91	1	3,91	CHI
20201233512	APARECIDA DE GOIANIA	200139393	INDEPENDENCIA S1	07/12/2020 12:43	07/12/2020 13:47	07/12/2020 12:43	07/12/2020 13:47	1,06	1	1,06	CHI
20201233516	JATAI	JT12264418	JATAI S1	07/12/2020 12:44	07/12/2020 15:40	07/12/2020 12:44	07/12/2020 15:40	2,92	1	2,92	CHI
20201233524	APORE	AE21138053	ITAJA S2	07/12/2020 12:48	08/12/2020 08:15	07/12/2020 12:48	08/12/2020 08:15	19,45	1	19,45	CHI
20201233647	SAO JOAO D ALIANCA	JL12383338	SAO JOAO D ALIANCA	07/12/2020 12:48	07/12/2020 16:58	07/12/2020 12:48	07/12/2020 16:58	4,15	1	4,15	CHI
20201233526	SANTA CRUZ DE GOIAS	BC31159644	CRISTIANOPOLIS	07/12/2020 12:49	07/12/2020 14:34	07/12/2020 12:49	07/12/2020 14:34	1,75	1	1,75	CHI
20201233539	VILA PROPICIO	7587203	GOIANESIA S1	07/12/2020 12:52	09/12/2020 15:15	07/12/2020 12:52	08/12/2020 22:22	33,50	43	1440,56	CHI
20201233539	VILA PROPICIO	NP12215082	GOIANESIA S1	07/12/2020 12:52	09/12/2020 15:15	07/12/2020 12:52	09/12/2020 11:40	46,79	5	233,97	CHI
20201233539	VILA PROPICIO	7587203	GOIANESIA S1	07/12/2020 12:52	09/12/2020 15:15	07/12/2020 12:52	09/12/2020 11:58	47,10	37	1742,55	CHI
20201233539	VILA PROPICIO	NP12228396LD	GOIANESIA S1	07/12/2020 12:52	09/12/2020 15:15	07/12/2020 12:52	09/12/2020 15:15	50,38	7	352,65	CHI
20201233541	SANTA TEREZINHA DE GOIAS	SG11403159	SANTA TEREZINHA	07/12/2020 12:52	07/12/2020 21:07	07/12/2020 12:52	07/12/2020 21:07	8,24	1	8,24	CHI
20201233549	GOIANESIA	550199627	GOIANESIA S2	07/12/2020 12:54	07/12/2020 15:53	07/12/2020 12:54	07/12/2020 15:53	2,98	1	2,98	CHI
20201233551	PALMEIRAS DE GOIAS	PL21287690	PALMEIRAS	07/12/2020 12:54	07/12/2020 18:06	07/12/2020 12:54	07/12/2020 18:06	5,20	1	5,20	CHI
20201233557	HIDROLINA	HL21190145	URUACU	07/12/2020 12:55	07/12/2020 19:28	07/12/2020 12:55	07/12/2020 19:28	6,54	1	6,54	CHI
20201233558	EDEIA	EA12044037	EDEIA	07/12/2020 12:55	07/12/2020 22:02	07/12/2020 12:55	07/12/2020 22:02	9,10	37	336,74	CHI
20201233560	GOIANIA	GN21000856	GOIANIA LESTE S3	07/12/2020 12:56	07/12/2020 14:10	07/12/2020 13:52	07/12/2020 14:10	0,30	1	0,30	CHI
20201233562	ITAUCU	110025039	INHUMAS S1	07/12/2020 12:56	07/12/2020 15:36	07/12/2020 12:56	07/12/2020 15:36	2,66	1	2,66	CHI
20201233567	SANTA RITA DO NOVO DESTINO	DF21243418	BARRO ALTO	07/12/2020 12:57	07/12/2020 19:38	07/12/2020 12:57	07/12/2020 19:38	6,67	1	6,67	CHI
20201234063	PARAUNA	PU12309537	MONTIVIDIU T	07/12/2020 12:57	07/12/2020 19:00	07/12/2020 12:57	07/12/2020 19:00	6,04	4	24,15	CHI
20201234168	NIQUELANDIA	NQ12366185	SAO JOAO D ALIANCA	07/12/2020 12:57	07/12/2020 19:28	07/12/2020 12:57	07/12/2020 19:28	6,51	6	39,06	CHI
20201234153	DIORAMA	DI12065691	IPORA	07/12/2020 12:58	07/12/2020 16:51	07/12/2020 12:58	07/12/2020 16:51	3,88	8	31,01	CHI
20201233575	CRISTALINA	KR21305288	CRISTALINA S1	07/12/2020 12:59	07/12/2020 20:09	07/12/2020 12:59	07/12/2020 20:09	7,16	1	7,16	CHI
20201233576	GOUVELANDIA	GB31067502	QUIRINOPOLIS	07/12/2020 12:59	07/12/2020 15:42	07/12/2020 12:59	07/12/2020 15:42	2,71	1	2,71	CHI
20201233577	SANTO ANTONIO DO DESCOBERTO	2210086535	AGUAS LINDAS DE GOIAS S2	07/12/2020 12:59	07/12/2020 14:48	07/12/2020 12:59	07/12/2020 14:48	1,80	1	1,80	CHI

20201233580	ITAPIRAPUA	IU12018752	MATRINCHA	07/12/2020 13:00	08/12/2020 09:59	07/12/2020 13:00	08/12/2020 09:59	20,97	7	146,82	CHI
20201233587	MORRINHOS	MR21381110	MORRINHOS	07/12/2020 13:01	07/12/2020 18:12	07/12/2020 13:01	07/12/2020 18:12	5,18	1	5,18	CHI
20201233589	ITAGUARI	10011152140	ITABERAI S1	07/12/2020 13:01	07/12/2020 15:35	07/12/2020 13:01	07/12/2020 15:35	2,55	1	2,55	CHI
20201233591	INHUMAS	IN12013728	INHUMAS S2	07/12/2020 13:03	07/12/2020 18:11	07/12/2020 13:03	07/12/2020 18:11	5,13	5	25,66	CHI
20201233593	GOIANIA	14435172	ATLANTICO S3	07/12/2020 13:03	07/12/2020 14:52	07/12/2020 13:03	07/12/2020 14:52	1,81	1	1,81	CHI
20201233601	JUSSARA	JR11169213	JUSSARA	07/12/2020 13:05	07/12/2020 16:50	07/12/2020 13:05	07/12/2020 16:50	3,76	9	33,85	CHI
20201233604	MORRINHOS	MR32092108	MORRINHOS	07/12/2020 13:06	07/12/2020 15:42	07/12/2020 13:06	07/12/2020 15:42	2,60	3	7,79	CHI
20201233609	ITAPURANGA	170033430	ITAPURANGA	07/12/2020 13:06	07/12/2020 14:53	07/12/2020 13:06	07/12/2020 14:53	1,77	1	1,77	CHI
20201234131	PIRACANJUBA	PJ12352525	PIRACANJUBA	07/12/2020 13:06	07/12/2020 17:46	07/12/2020 13:06	07/12/2020 17:46	4,66	16	74,53	CHI
20201233613	CATALAO	10033136139	CATALAO S2	07/12/2020 13:07	07/12/2020 17:31	07/12/2020 13:07	07/12/2020 17:31	4,39	0	0,00	CHI
20201233615	NEROPOLIS	160008074	NEROPOLIS S2	07/12/2020 13:08	07/12/2020 18:43	07/12/2020 13:08	07/12/2020 18:43	5,58	1	5,58	CHI
20201233617	MONTE ALEGRE DE GOIAS	MA21146879	SAO DOMINGOS	07/12/2020 13:08	07/12/2020 15:37	07/12/2020 13:08	07/12/2020 15:37	2,48	1	2,48	CHI
20201233660	CRISTALINA	KR12248743	CRISTALINA S2	07/12/2020 13:10	07/12/2020 15:01	07/12/2020 13:10	07/12/2020 15:01	1,85	3	5,55	CHI
20201233660	CRISTALINA	KR12248743	CRISTALINA S2	07/12/2020 13:10	07/12/2020 15:01	07/12/2020 13:10	07/12/2020 15:01	1,85	3	5,55	CHI
20201233637	SANTO ANTONIO DE GOIAS	GR12002132	NEROPOLIS S1	07/12/2020 13:11	08/12/2020 10:30	07/12/2020 13:11	08/12/2020 10:30	21,31	6	127,86	CHI
20201233640	LUZANIA	LZ12390041	CRISTALINA S2	07/12/2020 13:12	07/12/2020 14:24	07/12/2020 13:12	07/12/2020 14:24	1,20	10	11,99	CHI
20201233642	PALMINOPOLIS	PP21118047	PALMEIRAS	07/12/2020 13:12	07/12/2020 21:11	07/12/2020 13:12	07/12/2020 21:11	7,98	1	7,98	CHI
20201233644	ALTO PARAISO DE GOIAS	3870013471	FLORES DE GOIAS	07/12/2020 13:12	07/12/2020 19:07	07/12/2020 13:12	07/12/2020 19:07	5,91	1	5,91	CHI
20201233646	MINEIROS	MY21337074	PARQUE DAS EMAS	07/12/2020 13:12	08/12/2020 13:20	07/12/2020 13:12	08/12/2020 13:20	24,13	1	24,13	CHI
20201233648	URUACU	UR21117968	URUACU	07/12/2020 13:12	07/12/2020 15:41	07/12/2020 13:12	07/12/2020 15:41	2,47	1	2,47	CHI
20201233649	MOZARLANDIA	MZ21300435	MOZARLANDIA	07/12/2020 13:13	07/12/2020 21:27	07/12/2020 13:13	07/12/2020 21:27	8,23	1	8,23	CHI
20201233651	DOVERLANDIA	DV21151195	CAIAPONIA	07/12/2020 13:13	08/12/2020 18:03	07/12/2020 13:13	08/12/2020 18:03	28,82	1	28,82	CHI
20201233656	CRISTALINA	KR11273470	CRISTALINA S2	07/12/2020 13:14	07/12/2020 15:35	07/12/2020 13:14	07/12/2020 15:35	2,34	1	2,34	CHI
20201233658	PADRE BERNARDO	10031356999	PADRE BERNARDO	07/12/2020 13:14	07/12/2020 14:06	07/12/2020 13:14	07/12/2020 14:06	0,86	1	0,86	CHI
20201233664	QUIRINOPOLIS	QI21163423	QUIRINOPOLIS	07/12/2020 13:16	07/12/2020 15:00	07/12/2020 13:16	07/12/2020 15:00	1,73	1	1,73	CHI
20201233666	MAIRIPOTABA	MI12040025	PONTALINA	07/12/2020 13:16	08/12/2020 11:52	07/12/2020 13:16	08/12/2020 11:52	22,60	4	90,39	CHI
20201233670	PARAUNA	PU21215405	PARAUNA	07/12/2020 13:16	07/12/2020 17:08	07/12/2020 13:16	07/12/2020 17:08	3,86	1	3,86	CHI
20201233675	CALDAS NOVAS	760108547	CALDAS NOVAS S1	07/12/2020 13:18	07/12/2020 18:16	07/12/2020 13:18	07/12/2020 18:16	4,95	1	4,95	CHI
20201233693	MORRINHOS	MR12092107	MORRINHOS	07/12/2020 13:24	07/12/2020 17:43	07/12/2020 13:24	07/12/2020 17:43	4,32	2	8,63	CHI
20201233704	SENADOR CANEDO	10011750454	SENADOR CANEDO	07/12/2020 13:26	07/12/2020 14:49	07/12/2020 13:26	07/12/2020 14:49	1,38	1	1,38	CHI
20201233707	QUIRINOPOLIS	QI31014253	QUIRINOPOLIS	07/12/2020 13:27	07/12/2020 15:53	07/12/2020 13:27	07/12/2020 15:53	2,43	2	4,87	CHI
20201233714	ITAPIRAPUA	NB12396088	JUSSARA	07/12/2020 13:29	07/12/2020 16:50	07/12/2020 13:29	07/12/2020 16:50	3,36	4	13,44	CHI
20201233714	NOVO BRASIL	NB12396088	JUSSARA	07/12/2020 13:29	07/12/2020 16:50	07/12/2020 13:29	07/12/2020 16:50	3,36	5	16,80	CHI
20201233718	SILVANIA	SV12302189	CEPAIGO S2	07/12/2020 13:30	07/12/2020 17:26	07/12/2020 13:30	07/12/2020 17:26	3,93	2	7,87	CHI
20201233722	CAIAPONIA	10003980470	CAIAPONIA	07/12/2020 13:30	07/12/2020 16:09	07/12/2020 13:30	07/12/2020 16:09	2,64	1	2,64	CHI
20201233723	URUACU	UR12407359	URUACU	07/12/2020 13:30	08/12/2020 09:25	07/12/2020 13:30	08/12/2020 09:25	19,90	29	577,24	CHI
20201233723	PILAR DE GOIAS	UR12407359	URUACU	07/12/2020 13:30	08/12/2020 09:25	07/12/2020 13:30	08/12/2020 09:25	19,90	1	19,90	CHI
20201233723	NOVA IGUACU DE GOIAS	UR12407359	URUACU	07/12/2020 13:30	08/12/2020 09:25	07/12/2020 13:30	08/12/2020 09:25	19,90	20	398,09	CHI
20201233734	ITAJA	IJ12200688	ITAJA S2	07/12/2020 13:32	07/12/2020 15:53	07/12/2020 13:32	07/12/2020 15:53	2,34	4	9,37	CHI
20201233737	RIO VERDE	630534214	RIO VERDE S2	07/12/2020 13:32	07/12/2020 18:44	07/12/2020 13:32	07/12/2020 18:44	5,19	1	5,19	CHI
20201233739	SENADOR CANEDO	13282086	GOIANIA LESTE S1	07/12/2020 13:32	07/12/2020 16:22	07/12/2020 13:32	07/12/2020 16:22	2,82	1	2,82	CHI
20201233744	VALPARAISO DE GOIAS	2860225300	MARAJOARA	07/12/2020 13:34	07/12/2020 16:37	07/12/2020 13:34	07/12/2020 16:37	3,04	1	3,04	CHI
20201233746	BONOPOLIS	BX21083875	SAO MIGUEL DO ARAGUAIA	07/12/2020 13:34	07/12/2020 17:02	07/12/2020 13:34	07/12/2020 17:02	3,46	1	3,46	CHI
20201233747	GOIAS	GS12068612	MATRINCHA	07/12/2020 13:35	08/12/2020 16:33	07/12/2020 13:35	08/12/2020 16:33	26,96	3	80,89	CHI
20201233932	NOVA IGUACU DE GOIAS	AJ12143571RE	MARA ROSA	07/12/2020 13:35	07/12/2020 17:58	07/12/2020 13:35	07/12/2020 17:58	4,37	12	52,42	CHI
20201233932	MARA ROSA	AJ12143571RE	MARA ROSA	07/12/2020 13:35	07/12/2020 17:58	07/12/2020 13:35	07/12/2020 17:58	4,37	5	21,84	CHI
20201233932	ALTO HORIZONTE	AJ12143571RE	MARA ROSA	07/12/2020 13:35	07/12/2020 17:58	07/12/2020 13:35	07/12/2020 17:58	4,37	37	161,62	CHI
20201233754	ITAUCU	10017834501	ITABERAI S1	07/12/2020 13:37	07/12/2020 21:43	07/12/2020 13:37	07/12/2020 21:43	8,10	1	8,10	CHI
20201233755	MORRO AGUDO DE GOIAS	MS21210982	ITAPURANGA	07/12/2020 13:37	07/12/2020 20:34	07/12/2020 13:37	07/12/2020 20:34	6,94	1	6,94	CHI
20201233757	CRISTALINA	KR21133600	PAMPLONA	07/12/2020 13:37	07/12/2020 21:17	07/12/2020 13:37	07/12/2020 21:17	7,66	3	22,97	CHI
20201233768	IPORA	IR11014457	IPORA	07/12/2020 13:40	07/12/2020 17:08	07/12/2020 16:30	07/12/2020 17:08	0,64	85	54,54	CHI

20201233771	LUZIANIA	LZ21261108	MARAJOARA	07/12/2020 13:40	08/12/2020 01:26	07/12/2020 13:40	08/12/2020 01:26	11,75	1	11,75	CHI
20201233776	MORRINHOS	150045384	MORRINHOS	07/12/2020 13:42	07/12/2020 16:47	07/12/2020 13:42	07/12/2020 16:47	3,08	1	3,08	CHI
20201233783	AGUA FRIA DE GOIAS	TL21076103	SAO JOAO D ALIANCA	07/12/2020 13:45	08/12/2020 13:37	07/12/2020 13:45	08/12/2020 13:37	23,87	1	23,87	CHI
20201233845	PONTALINA	PK12181924	VICENTINOPOLIS	07/12/2020 13:46	08/12/2020 09:52	07/12/2020 13:46	08/12/2020 09:52	20,09	21	421,81	CHI
20201233791	CAMPINORTE	MQ21333947	MARA ROSA	07/12/2020 13:48	08/12/2020 09:33	07/12/2020 13:48	08/12/2020 09:33	19,75	1	19,75	CHI
20201233792	QUIRINOPOLIS	80055813	QUIRINOPOLIS	07/12/2020 13:48	07/12/2020 16:37	07/12/2020 13:48	07/12/2020 16:37	2,81	1	2,81	CHI
20201233799	SILVANIA	SV21157830	VIANOPOLIS	07/12/2020 13:49	07/12/2020 15:54	07/12/2020 13:49	07/12/2020 15:54	2,07	1	2,07	CHI
20201233801	APARECIDA DE GOIANIA	14597640	INDEPENDENCIA S1	07/12/2020 13:50	07/12/2020 19:45	07/12/2020 13:50	07/12/2020 19:45	5,92	1	5,92	CHI
20201233809	RIO VERDE	630042780	RIO VERDE S1	07/12/2020 13:53	07/12/2020 16:44	07/12/2020 13:53	07/12/2020 16:44	2,84	1	2,84	CHI
20201233810	SAO SIMAO	SO21000025	CACHOEIRA ALTA	07/12/2020 13:53	07/12/2020 16:48	07/12/2020 13:53	07/12/2020 16:48	2,91	2	5,82	CHI
20201233812	JARAGUA	10015024928	JARAGUA	07/12/2020 13:53	07/12/2020 19:59	07/12/2020 13:53	07/12/2020 19:59	6,08	1	6,08	CHI
20201233815	SILVANIA	SV21241101	VIANOPOLIS	07/12/2020 13:54	07/12/2020 20:26	07/12/2020 13:54	07/12/2020 20:26	6,52	1	6,52	CHI
20201233816	ANHANGUERA	AH21169588	CATALAO S1	07/12/2020 13:54	07/12/2020 19:03	07/12/2020 13:54	07/12/2020 19:03	5,14	1	5,14	CHI
20201233817	PALESTINA DE GOIAS	AY12390161	ARENOPOLIS	07/12/2020 13:54	09/12/2020 11:02	07/12/2020 13:54	09/12/2020 11:02	45,12	4	180,47	CHI
20201233819	PADRE BERNARDO	PB21330806	PADRE BERNARDO	07/12/2020 13:55	07/12/2020 17:08	07/12/2020 13:55	07/12/2020 17:08	3,22	1	3,22	CHI
20201233820	BOM JESUS DE GOIAS	BJ12000078	BOM JESUS DE GOIAS	07/12/2020 13:55	08/12/2020 17:04	07/12/2020 13:55	08/12/2020 17:04	27,15	3	81,44	CHI
20201234247	ALVORADA DO NORTE	AQ12322731	IACIARA S2	07/12/2020 13:55	07/12/2020 17:16	07/12/2020 13:55	07/12/2020 17:16	3,35	58	194,30	CHI
20201234247	FLORES DE GOIAS	AQ12322731	IACIARA S2	07/12/2020 13:55	07/12/2020 17:16	07/12/2020 13:55	07/12/2020 17:16	3,35	36	120,60	CHI
20201233832	LUZIANIA	LZ21000582	MARAJOARA	07/12/2020 13:58	07/12/2020 22:38	07/12/2020 13:58	07/12/2020 22:38	8,65	1	8,65	CHI
20201233833	APARECIDA DE GOIANIA	17449870	INDEPENDENCIA S1	07/12/2020 13:59	07/12/2020 15:47	07/12/2020 13:59	07/12/2020 15:47	1,80	1	1,80	CHI
20201233834	CALDAS NOVAS	CN21207637	CALDAS NOVAS S1	07/12/2020 13:59	07/12/2020 15:29	07/12/2020 13:59	07/12/2020 15:29	1,50	1	1,50	CHI
20201233835	SENADOR CANEDO	16447414	GOIANIA LESTE S2	07/12/2020 13:59	07/12/2020 15:07	07/12/2020 13:59	07/12/2020 15:07	1,13	1	1,13	CHI
20201233883	INDIARA	IY12233476	EDEIA	07/12/2020 14:00	07/12/2020 17:06	07/12/2020 14:00	07/12/2020 17:06	3,10	39	120,82	CHI
20201234070	CRIXAS	CX12377839	RUBIATABA	07/12/2020 14:00	07/12/2020 18:10	07/12/2020 14:00	07/12/2020 18:10	4,16	13	54,08	CHI
20201233843	MORRINHOS	MR21236348	MORRINHOS	07/12/2020 14:01	07/12/2020 19:18	07/12/2020 14:01	07/12/2020 19:18	5,28	2	10,56	CHI
20201234561	EDEIA	EA12000059RE	EDEIA	07/12/2020 14:01	07/12/2020 22:02	07/12/2020 14:01	07/12/2020 22:02	8,01	55	440,66	CHI
20201233847	AGUA FRIA DE GOIAS	TL21228653	SAO JOAO D ALIANCA	07/12/2020 14:02	08/12/2020 14:09	07/12/2020 14:02	08/12/2020 14:09	24,12	1	24,12	CHI
20201233855	MORRINHOS	MR21223298	MORRINHOS	07/12/2020 14:03	07/12/2020 21:36	07/12/2020 14:03	07/12/2020 21:36	7,54	1	7,54	CHI
20201233861	TRINDADE	40109598	TRINDADE	07/12/2020 14:04	07/12/2020 16:06	07/12/2020 14:04	07/12/2020 16:06	2,03	1	2,03	CHI
20201233867	MONTIVIDIU DO NORTE	MX12187845RE	PORANGATU	07/12/2020 14:05	08/12/2020 00:03	07/12/2020 14:05	08/12/2020 00:03	9,96	13	129,54	CHI
20201233869	CAIAPONIA	930002179	CAIAPONIA	07/12/2020 14:05	07/12/2020 17:31	07/12/2020 14:05	07/12/2020 17:31	3,43	1	3,43	CHI
20201233870	GOUVELANDIA	2250019971	QUIRINOPOLIS	07/12/2020 14:05	07/12/2020 17:55	07/12/2020 14:05	07/12/2020 17:55	3,83	1	3,83	CHI
20201233876	PADRE BERNARDO	10008583348	PADRE BERNARDO	07/12/2020 14:06	07/12/2020 16:31	07/12/2020 14:06	07/12/2020 16:31	2,41	1	2,41	CHI
20201233877	ACREUNA	EU12000138	ACREUNA	07/12/2020 14:06	07/12/2020 15:06	07/12/2020 14:06	07/12/2020 15:06	0,99	344	342,18	CHI
20201233880	APARECIDA DE GOIANIA	AP11383872	INDEPENDENCIA S2	07/12/2020 14:06	07/12/2020 14:17	07/12/2020 14:06	07/12/2020 14:17	0,18	63	11,06	CHI
20201233881	APARECIDA DE GOIANIA	12238820	ATLANTICO S3	07/12/2020 14:06	07/12/2020 17:12	07/12/2020 14:06	07/12/2020 17:12	3,09	1	3,09	CHI
20201235584	CACHOEIRA DOURADA	CD12222446	CACHOEIRA DOURADA	07/12/2020 14:06	08/12/2020 08:02	07/12/2020 14:06	08/12/2020 08:02	17,92	3	53,77	CHI
20201233885	FLORES DE GOIAS	FB12243096	FLORES DE GOIAS	07/12/2020 14:07	08/12/2020 10:44	07/12/2020 14:07	08/12/2020 10:44	20,61	5	103,05	CHI
20201235052	LUZIANIA	LZ12110889	RIO VERMELHO	07/12/2020 14:07	07/12/2020 19:48	07/12/2020 14:07	07/12/2020 19:48	5,67	7	39,70	CHI
20201233891	ITAJA	IJ12200626	ITAJA S2	07/12/2020 14:08	07/12/2020 16:33	07/12/2020 14:08	07/12/2020 16:33	2,41	7	16,90	CHI
20201234284	MARA ROSA	MQ12136490	MARA ROSA	07/12/2020 14:08	07/12/2020 17:58	07/12/2020 14:08	07/12/2020 17:58	3,82	4	15,27	CHI
20201235559	MINEIROS	CP12330199	JATAI S1	07/12/2020 14:08	08/12/2020 15:36	07/12/2020 14:08	08/12/2020 15:36	25,45	1	25,45	CHI
20201235559	CAIAPONIA	CP12330199	JATAI S1	07/12/2020 14:08	08/12/2020 15:36	07/12/2020 14:08	08/12/2020 15:36	25,45	2	50,90	CHI
20201233897	CACU	CC21323983	CACHOEIRA ALTA	07/12/2020 14:09	07/12/2020 17:22	07/12/2020 14:09	07/12/2020 17:22	3,21	1	3,21	CHI
20201233899	CORUMBAIBA	MG12000361	VILA CORUMBA	07/12/2020 14:09	07/12/2020 14:51	07/12/2020 14:09	07/12/2020 14:51	0,69	2	1,38	CHI
20201233899	CALDAS NOVAS	MG12000361	VILA CORUMBA	07/12/2020 14:09	07/12/2020 14:51	07/12/2020 14:09	07/12/2020 14:51	0,69	3	2,07	CHI
20201233900	ITAPURANGA	IK12300186	ITAPURANGA	07/12/2020 14:09	07/12/2020 16:43	07/12/2020 14:09	07/12/2020 16:43	2,56	40	102,26	CHI
20201233902	SAO SIMAO	PC12271237	CACHOEIRA ALTA	07/12/2020 14:10	07/12/2020 16:04	07/12/2020 14:10	07/12/2020 16:04	1,90	1	1,90	CHI
20201234559	ITAPIRAPUA	IU12077173	JUSSARA	07/12/2020 14:11	08/12/2020 08:50	07/12/2020 14:11	08/12/2020 08:50	18,64	6	111,87	CHI
20201233916	CORUMBAIBA	CI12000481	VILA CORUMBA	07/12/2020 14:12	07/12/2020 23:13	07/12/2020 14:12	07/12/2020 23:13	9,00	2	18,00	CHI
20201235077	FAZENDA NOVA	FN12378899	JUSSARA	07/12/2020 14:12	08/12/2020 10:38	07/12/2020 14:12	08/12/2020 10:38	20,42	10	204,22	CHI

20201234255	PIRENOPOLIS	PV12000461	SAO FRANCISCO DE GOIAS	07/12/2020 14:13	07/12/2020 20:34	07/12/2020 14:13	07/12/2020 20:34	6,35	68	431,52	CHI
20201233928	PORANGATU	PO12021172	PORANGATU	07/12/2020 14:14	07/12/2020 15:27	07/12/2020 14:14	07/12/2020 15:27	1,20	5	6,02	CHI
20201233929	PIRES DO RIO	PR21372399	PIRES DO RIO S1	07/12/2020 14:15	07/12/2020 16:59	07/12/2020 14:15	07/12/2020 16:59	2,73	2	5,45	CHI
20201234380	SAO JOAO D ALIANCA	JL12383335	SAO JOAO D ALIANCA	07/12/2020 14:15	07/12/2020 17:24	07/12/2020 14:15	07/12/2020 17:24	3,14	11	34,52	CHI
20201233942	ORIZONA	OZ21404202	VIANOPOLIS	07/12/2020 14:18	07/12/2020 20:35	07/12/2020 14:18	07/12/2020 20:35	6,28	1	6,28	CHI
20201233943	JARAGUA	JA21306908	JARAGUA	07/12/2020 14:18	08/12/2020 08:20	07/12/2020 14:18	08/12/2020 08:20	18,04	1	18,04	CHI
20201233944	AGUAS LINDAS DE GOIAS	4830162534	AGUAS LINDAS DE GOIAS S1	07/12/2020 14:18	07/12/2020 16:50	07/12/2020 14:18	07/12/2020 16:50	2,52	1	2,52	CHI
20201235471	MARA ROSA	MQ12295280	MARA ROSA	07/12/2020 14:18	07/12/2020 22:48	07/12/2020 14:18	07/12/2020 22:48	8,48	4	33,94	CHI
20201233950	GOIANIA	GN11233011	GOIANIA LESTE S3	07/12/2020 14:20	07/12/2020 19:10	07/12/2020 15:57	07/12/2020 19:10	3,22	25	80,42	CHI
20201234170	SILVANIA	SV12254376	VIANOPOLIS	07/12/2020 14:20	07/12/2020 22:57	07/12/2020 14:20	07/12/2020 22:57	8,62	18	155,14	CHI
20201233953	MONTIVIDIU	MV21213426	MONTIVIDIU T	07/12/2020 14:22	08/12/2020 08:55	07/12/2020 14:22	08/12/2020 08:55	18,55	2	37,09	CHI
20201233965	CACU	1140003541	CACHOEIRA ALTA	07/12/2020 14:23	07/12/2020 17:16	07/12/2020 14:23	07/12/2020 17:16	2,87	1	2,87	CHI
20201233969	GOIANIA	10541305	REAL S2	07/12/2020 14:24	07/12/2020 16:06	07/12/2020 14:24	07/12/2020 16:06	1,69	1	1,69	CHI
20201234362	CAIAPONIA	CP12344723	MONTIVIDIU T	07/12/2020 14:24	08/12/2020 09:03	07/12/2020 14:24	08/12/2020 09:03	18,64	8	149,14	CHI
20201234829	CRISTALINA	KR21195570	PAMPLONA	07/12/2020 14:24	07/12/2020 23:58	07/12/2020 14:24	07/12/2020 23:58	9,56	1	9,56	CHI
20201233971	ITUMBIARA	690270525	ITUMBIARA NOVA	07/12/2020 14:25	08/12/2020 09:55	07/12/2020 14:25	08/12/2020 09:55	19,50	1	19,50	CHI
20201233972	MINEIROS	MY21301847	PARQUE DAS EMAS	07/12/2020 14:25	08/12/2020 17:22	07/12/2020 14:25	08/12/2020 17:22	26,95	1	26,95	CHI
20201233973	PIRACANJUBA	60016048	PIRACANJUBA	07/12/2020 14:25	07/12/2020 18:12	07/12/2020 14:25	07/12/2020 18:12	3,78	1	3,78	CHI
20201235914	JARAGUA	JA12029022	JARAGUA	07/12/2020 14:25	07/12/2020 23:18	07/12/2020 14:25	07/12/2020 23:18	8,87	157	1393,37	CHI
20201234396	CRISTALINA	KR11032819	PAMPLONA	07/12/2020 14:26	07/12/2020 20:24	07/12/2020 19:33	07/12/2020 20:24	0,84	71	59,82	CHI
20201233980	ITUMBIARA	IT21273890	ITUMBIARA NOVA	07/12/2020 14:27	07/12/2020 19:54	07/12/2020 14:27	07/12/2020 19:54	5,44	2	10,88	CHI
20201233982	ITABERAI	IB12220127	ITABERAI S1	07/12/2020 14:27	07/12/2020 15:55	07/12/2020 14:27	07/12/2020 15:55	1,45	289	419,37	CHI
20201234533	ALEXANIA	7595419	ALEXANIA	07/12/2020 14:27	07/12/2020 17:59	07/12/2020 14:27	07/12/2020 17:59	3,53	36	127,05	CHI
20201233989	GOIANAPOLIS	10010024970	DAIA S2	07/12/2020 14:28	07/12/2020 18:04	07/12/2020 14:28	07/12/2020 18:04	3,60	1	3,60	CHI
20201233990	GOIANIA	12345738	CAMPINAS S2	07/12/2020 14:28	07/12/2020 16:07	07/12/2020 14:28	07/12/2020 16:07	1,64	1	1,64	CHI
20201233996	CRISTALINA	KR12163679	PAMPLONA	07/12/2020 14:28	07/12/2020 18:51	07/12/2020 14:28	07/12/2020 18:51	4,38	5	21,88	CHI
20201234191	MINEIROS	MY12217015LD	PARQUE DAS EMAS	07/12/2020 14:29	08/12/2020 09:02	07/12/2020 14:29	08/12/2020 09:02	18,54	9	166,84	CHI
20201234191	DOVERLANDIA	MY12217015LD	PARQUE DAS EMAS	07/12/2020 14:29	08/12/2020 09:02	07/12/2020 14:29	08/12/2020 09:02	18,54	31	574,67	CHI
20201233995	RIO VERDE	10010984117	RIO VERDE S1	07/12/2020 14:30	07/12/2020 21:43	07/12/2020 14:30	07/12/2020 21:43	7,22	1	7,22	CHI
20201233998	GOIANIA	16734440	GOIANIA LESTE S3	07/12/2020 14:30	07/12/2020 17:17	07/12/2020 14:30	07/12/2020 17:17	2,78	1	2,78	CHI
20201233999	CACHOEIRA ALTA	CA11202774	CACHOEIRA ALTA	07/12/2020 14:30	07/12/2020 19:48	07/12/2020 18:20	07/12/2020 19:48	1,47	76	111,47	CHI
20201235562	MINACU	IH12208346	MINACU	07/12/2020 14:30	07/12/2020 21:50	07/12/2020 14:30	07/12/2020 21:50	7,32	12	87,86	CHI
20201234015	APORE	AE12202623	ITAJA S2	07/12/2020 14:33	07/12/2020 19:39	07/12/2020 14:33	07/12/2020 19:39	5,10	1	5,10	CHI
20201234016	APARECIDA DE GOIANIA	200293930	ANHANGUERA	07/12/2020 14:33	07/12/2020 17:45	07/12/2020 14:33	07/12/2020 17:45	3,19	1	3,19	CHI
20201234021	CACHOEIRA DOURADA	CD12222373	CACHOEIRA DOURADA	07/12/2020 14:33	07/12/2020 19:24	07/12/2020 14:33	07/12/2020 19:24	4,83	2	9,67	CHI
20201234027	FLORES DE GOIAS	FB21164518	FLORES DE GOIAS	07/12/2020 14:34	07/12/2020 23:05	07/12/2020 14:34	07/12/2020 23:05	8,50	1	8,50	CHI
20201234038	BURITI DE GOIAS	BS12308643	FIRMINOPOLIS S2	07/12/2020 14:37	07/12/2020 19:23	07/12/2020 14:37	07/12/2020 19:23	4,76	7	33,35	CHI
20201234039	INHUMAS	IN21222334	INHUMAS S2	07/12/2020 14:37	08/12/2020 20:41	07/12/2020 14:37	07/12/2020 20:41	6,06	1	6,06	CHI
20201234043	PIRENOPOLIS	PV21016643	CORUMBA	07/12/2020 14:37	08/12/2020 11:16	07/12/2020 14:37	08/12/2020 11:16	20,64	1	20,64	CHI
20201234047	PIRACANJUBA	PJ21000090	PIRACANJUBA	07/12/2020 14:39	08/12/2020 00:27	07/12/2020 14:39	08/12/2020 00:27	9,79	2	19,59	CHI
20201234280	IPAMERI	IP11128715	CRISTALINA S1	07/12/2020 14:39	07/12/2020 18:59	07/12/2020 14:39	07/12/2020 18:59	4,33	133	576,37	CHI
20201234052	CORREGO DO OURO	CO12056069	FIRMINOPOLIS S2	07/12/2020 14:40	07/12/2020 16:53	07/12/2020 14:40	07/12/2020 16:53	2,22	3	6,65	CHI
20201234054	JATAI	JT21135914	JATAI S2	07/12/2020 14:40	08/12/2020 10:05	07/12/2020 14:40	08/12/2020 10:05	19,41	1	19,41	CHI
20201234842	PARAUNA	PU12194225	FIRMINOPOLIS S2	07/12/2020 14:40	07/12/2020 23:23	07/12/2020 14:40	07/12/2020 23:23	8,70	12	104,43	CHI
20201234058	JATAI	290295490	JATAI S2	07/12/2020 14:41	08/12/2020 16:00	07/12/2020 14:41	08/12/2020 16:00	25,32	1	25,32	CHI
20201234059	PORANGATU	PO12375475	PORANGATU	07/12/2020 14:41	07/12/2020 21:30	07/12/2020 14:41	07/12/2020 21:30	6,81	2	13,62	CHI
20201234064	ORIZONA	OZ21170417	PIRES DO RIO S2	07/12/2020 14:42	07/12/2020 20:16	07/12/2020 14:42	07/12/2020 20:16	5,56	1	5,56	CHI
20201234067	CRISTALINA	KR12276494	CRISTALINA S2	07/12/2020 14:42	07/12/2020 16:58	07/12/2020 14:42	07/12/2020 16:58	2,25	5	11,27	CHI
20201234069	PIRACANJUBA	BV21132537	BELA VISTA S1	07/12/2020 14:42	08/12/2020 09:29	07/12/2020 14:42	08/12/2020 09:29	18,77	3	56,30	CHI
20201234081	GOIANIA	15399278	MEIA PONTE	07/12/2020 14:44	07/12/2020 17:39	07/12/2020 14:44	07/12/2020 17:39	2,90	1	2,90	CHI
20201234088	SANTO ANTONIO DO DESCOBERTO	10021713144	ALEXANIA	07/12/2020 14:46	07/12/2020 16:25	07/12/2020 14:46	07/12/2020 16:25	1,65	1	1,65	CHI

20201234089	INHUMAS	IN21168375	INHUMAS S1	07/12/2020 14:46	07/12/2020 18:22	07/12/2020 14:46	07/12/2020 18:22	3,59	2	7,19	CHI
20201234090	HIDROLANDIA	HD11313107	CEPAIGO S2	07/12/2020 14:46	07/12/2020 15:59	07/12/2020 14:46	07/12/2020 15:59	1,21	10	12,09	CHI
20201234091	SANTA RITA DO ARAGUAIA	SU11256764	SANTA RITA DO ARAGUAIA	07/12/2020 14:46	07/12/2020 22:51	07/12/2020 14:46	07/12/2020 22:51	8,07	1	8,07	CHI
20201234105	INDIARA	IY12391274	EDEIA	07/12/2020 14:47	07/12/2020 19:55	07/12/2020 14:47	07/12/2020 19:55	5,13	4	20,51	CHI
20201234107	BARRO ALTO	BA21013154	BARRO ALTO	07/12/2020 14:48	07/12/2020 15:36	07/12/2020 14:48	07/12/2020 15:36	0,80	1	0,80	CHI
20201234111	GOUVELANDIA	GB21000352	QUIRINOPOLIS	07/12/2020 14:48	07/12/2020 17:24	07/12/2020 14:48	07/12/2020 17:24	2,59	1	2,59	CHI
20201234337	GOIANIRA	GR11287759	MEIA PONTE	07/12/2020 14:48	07/12/2020 17:10	07/12/2020 14:48	07/12/2020 17:10	2,36	161	380,63	CHI
20201235435	FLORES DE GOIAS	FB12106993	FLORES DE GOIAS	07/12/2020 14:48	07/12/2020 23:05	07/12/2020 14:48	07/12/2020 23:05	8,28	13	107,66	CHI
20201235435	FORMOSA	FB12106993	FLORES DE GOIAS	07/12/2020 14:48	07/12/2020 23:05	07/12/2020 14:48	07/12/2020 23:05	8,28	21	173,91	CHI
20201235435	SAO JOAO D ALIANCA	FB12106993	FLORES DE GOIAS	07/12/2020 14:48	07/12/2020 23:05	07/12/2020 14:48	07/12/2020 23:05	8,28	5	41,41	CHI
20201234115	GOIANIA	17357202	CARAJAS S1	07/12/2020 14:49	07/12/2020 15:44	07/12/2020 14:49	07/12/2020 15:44	0,91	1	0,91	CHI
20201234117	JATAI	JT12226459	JATAI S1	07/12/2020 14:49	08/12/2020 13:39	07/12/2020 14:49	08/12/2020 13:39	22,82	2	45,65	CHI
20201234122	NOVO GAMA	4990020560	PACAEMBU S1	07/12/2020 14:50	07/12/2020 22:13	07/12/2020 14:50	07/12/2020 22:13	7,37	1	7,37	CHI
20201234129	VILA BOA	FA21322702	ITUIQUIRA	07/12/2020 14:52	07/12/2020 16:54	07/12/2020 14:52	07/12/2020 16:54	2,03	1	2,03	CHI
20201235322	ITAPACI	IW21388235	RUBIATABA	07/12/2020 14:53	07/12/2020 21:49	07/12/2020 14:53	07/12/2020 21:49	6,92	2	13,84	CHI
20201234139	CAMPO ALEGRE DE GOIAS	CM12042502	CAMPO ALEGRE DE GOIAS	07/12/2020 14:54	07/12/2020 18:48	07/12/2020 14:54	07/12/2020 18:48	3,89	9	35,00	CHI
20201234349	PADRE BERNARDO	PB12344764	PADRE BERNARDO	07/12/2020 14:54	07/12/2020 19:27	07/12/2020 14:54	07/12/2020 19:27	4,54	10	45,42	CHI
20201234143	PIRES DO RIO	PR12344664	PIRES DO RIO S2	07/12/2020 14:55	07/12/2020 18:10	07/12/2020 14:55	07/12/2020 18:10	3,24	2	6,47	CHI
20201234148	DOVERLANDIA	DV21156597	CAIAPONIA	07/12/2020 14:56	07/12/2020 16:59	07/12/2020 14:56	07/12/2020 16:59	2,04	1	2,04	CHI
20201234154	APORE	AE21205149	ITAJA S2	07/12/2020 14:57	08/12/2020 07:14	07/12/2020 14:57	08/12/2020 07:14	16,27	2	32,55	CHI
20201234164	INDIARA	IY12057315	EDEIA	07/12/2020 14:59	07/12/2020 21:21	07/12/2020 14:59	07/12/2020 21:21	6,38	5	31,89	CHI
20201234166	NEROPOLIS	160052610	NEROPOLIS S2	07/12/2020 14:59	07/12/2020 22:57	07/12/2020 14:59	07/12/2020 22:57	7,96	1	7,96	CHI
20201234644	PIRANHAS	PH12048738	PIRANHAS	07/12/2020 14:59	07/12/2020 20:39	07/12/2020 14:59	07/12/2020 20:39	5,66	3	16,99	CHI
20201234179	CRISTALINA	IP21165536	CRISTALINA S1	07/12/2020 15:01	07/12/2020 21:24	07/12/2020 15:01	07/12/2020 21:24	6,38	1	6,38	CHI
20201234181	FAZENDA NOVA	FN21073608	BRITANIA	07/12/2020 15:01	08/12/2020 08:31	07/12/2020 15:01	08/12/2020 08:31	17,49	1	17,49	CHI
20201234693	NEROPOLIS	NR12194033LD	NEROPOLIS S2	07/12/2020 15:03	07/12/2020 19:30	07/12/2020 15:03	07/12/2020 19:30	4,45	454	2020,17	CHI
20201234198	SAO JOAO D ALIANCA	JL11238296	ITUIQUIRA	07/12/2020 15:04	09/12/2020 10:40	07/12/2020 15:04	09/12/2020 10:40	43,60	1	43,60	CHI
20201234200	ITABERAI	IB21281186	ITABERAI S1	07/12/2020 15:04	07/12/2020 16:59	07/12/2020 15:04	07/12/2020 16:59	1,91	1	1,91	CHI
20201234246	SILVANIA	SV12202383	CEPAIGO S2	07/12/2020 15:04	07/12/2020 18:32	07/12/2020 15:04	07/12/2020 18:32	3,47	4	13,86	CHI
20201234246	CALDAZINHA	SV12202383	CEPAIGO S2	07/12/2020 15:04	07/12/2020 18:32	07/12/2020 15:04	07/12/2020 18:32	3,47	14	48,52	CHI
20201234209	FORMOSA	610020869	ITUIQUIRA	07/12/2020 15:05	08/12/2020 11:12	07/12/2020 15:05	08/12/2020 11:12	20,11	1	20,11	CHI
20201234211	GOIANIA	10005427965	ATLANTICO S3	07/12/2020 15:06	07/12/2020 17:14	07/12/2020 15:06	07/12/2020 17:14	2,13	1	2,13	CHI
20201234213	GOIANIA	10001175724	CARAJAS S1	07/12/2020 15:07	07/12/2020 16:19	07/12/2020 15:07	07/12/2020 16:19	1,20	1	1,20	CHI
20201234220	GUARINOS	GF21314381	SANTA TEREZINHA	07/12/2020 15:08	08/12/2020 08:25	07/12/2020 15:08	08/12/2020 08:25	17,27	1	17,27	CHI
20201234226	INACIOLANDIA	ID12271589	CACHOEIRA DOURADA	07/12/2020 15:10	07/12/2020 17:32	07/12/2020 15:10	07/12/2020 17:32	2,36	16	37,72	CHI
20201234227	DIVINOPOLIS DE GOIAS	2570000675	SAO DOMINGOS	07/12/2020 15:11	07/12/2020 18:04	07/12/2020 15:11	07/12/2020 18:04	2,88	1	2,88	CHI
20201234228	FORMOSA	610076553	ITUIQUIRA	07/12/2020 15:11	08/12/2020 11:44	07/12/2020 15:11	08/12/2020 11:44	20,54	1	20,54	CHI
20201234233	GOIANIA	13168800	GOYA S1	07/12/2020 15:12	07/12/2020 17:18	07/12/2020 15:12	07/12/2020 17:18	2,09	1	2,09	CHI
20201234241	MONTES CLAROS DE GOIAS	ME12204930	IPORA	07/12/2020 15:13	07/12/2020 17:09	07/12/2020 15:13	07/12/2020 17:09	1,92	2	3,85	CHI
20201234568	CAIAPONIA	CP12207949RE	CAIAPONIA	07/12/2020 15:13	08/12/2020 04:23	07/12/2020 15:13	08/12/2020 04:23	13,16	123	1618,75	CHI
20201234568	PIRANHAS	CP12207949RE	CAIAPONIA	07/12/2020 15:13	08/12/2020 04:23	07/12/2020 15:13	08/12/2020 04:23	13,16	12	157,93	CHI
20201234240	INACIOLANDIA	ID21000338	CACHOEIRA DOURADA	07/12/2020 15:14	07/12/2020 18:45	07/12/2020 15:14	07/12/2020 18:45	3,51	2	7,02	CHI
20201234243	INDIARA	PL12051523	EDEIA	07/12/2020 15:14	07/12/2020 18:14	07/12/2020 15:14	07/12/2020 18:14	2,99	2	5,98	CHI
20201234249	MORRINHOS	MR12000140	MORRINHOS	07/12/2020 15:15	08/12/2020 14:53	07/12/2020 15:15	07/12/2020 19:49	4,56	3	13,69	CHI
20201234249	MORRINHOS	MR12000140	MORRINHOS	07/12/2020 15:15	08/12/2020 14:53	08/12/2020 09:12	08/12/2020 14:47	5,59	3	16,76	CHI
20201234249	MORRINHOS	MR21000094	MORRINHOS	07/12/2020 15:15	08/12/2020 14:53	07/12/2020 15:15	08/12/2020 14:53	23,62	1	23,62	CHI
20201234254	PIRENOPOLIS	ZN21345258	COCALZINHO	07/12/2020 15:17	08/12/2020 03:42	07/12/2020 15:17	08/12/2020 03:42	12,40	2	24,80	CHI
20201235101	HIDROLANDIA	HD12200115	CEPAIGO S2	07/12/2020 15:17	07/12/2020 20:02	07/12/2020 15:17	07/12/2020 20:02	4,75	9	42,72	CHI
20201236052	HIDROLINA	GE12382134	BARRO ALTO	07/12/2020 15:18	08/12/2020 10:54	07/12/2020 15:18	08/12/2020 10:54	19,59	1	19,59	CHI
20201236052	SAO LUIZ DO NORTE	GE12382134	BARRO ALTO	07/12/2020 15:18	08/12/2020 10:54	07/12/2020 15:18	08/12/2020 10:54	19,59	8	156,76	CHI
20201234260	PORANGATU	PO21320763	PORANGATU	07/12/2020 15:19	08/12/2020 10:57	07/12/2020 15:19	08/12/2020 10:57	19,63	1	19,63	CHI

20201234262	VICENTINOPOLIS	VI21198651	VICENTINOPOLIS	07/12/2020 15:19	08/12/2020 14:43	07/12/2020 15:19	08/12/2020 14:43	23,39	1	23,39	CHI
20201234688	ITAPIRAPUA	IU12341192	JUSSARA	07/12/2020 15:19	08/12/2020 10:40	07/12/2020 15:19	08/12/2020 10:40	19,36	9	174,21	CHI
20201234265	APARECIDA DE GOIANIA	12621353	REAL S1	07/12/2020 15:20	07/12/2020 17:13	07/12/2020 15:20	07/12/2020 17:13	1,88	1	1,88	CHI
20201234266	SANTO ANTONIO DE GOIAS	BW21198319	NEROPOLIS S1	07/12/2020 15:20	08/12/2020 03:13	07/12/2020 15:20	08/12/2020 03:13	11,87	1	11,87	CHI
20201234273	APARECIDA DE GOIANIA	200212310	INDEPENDENCIA S1	07/12/2020 15:21	07/12/2020 16:54	07/12/2020 15:21	07/12/2020 16:54	1,54	1	1,54	CHI
20201234472	ITAGUARI	JA12390106	ITABERAI S1	07/12/2020 15:21	07/12/2020 23:51	07/12/2020 15:21	07/12/2020 23:51	8,49	4	33,97	CHI
20201234472	JESUPOLIS	JA12390106	ITABERAI S1	07/12/2020 15:21	07/12/2020 23:51	07/12/2020 15:21	07/12/2020 23:51	8,49	1	8,49	CHI
20201234472	JARAGUA	JA12390106	ITABERAI S1	07/12/2020 15:21	07/12/2020 23:51	07/12/2020 15:21	07/12/2020 23:51	8,49	9	76,43	CHI
20201234281	JATAI	10008400464	JATAI S2	07/12/2020 15:22	08/12/2020 11:59	07/12/2020 15:22	08/12/2020 11:59	20,62	1	20,62	CHI
20201234282	CALDAS NOVAS	760354340	CALDAS NOVAS S2	07/12/2020 15:22	07/12/2020 23:15	07/12/2020 15:22	07/12/2020 23:15	7,87	1	7,87	CHI
20201234405	TRINDADE	TR12242149	TRINDADE	07/12/2020 15:22	07/12/2020 18:56	07/12/2020 15:22	07/12/2020 18:55	3,56	156	555,75	CHI
20201234405	TRINDADE	TR12242149	TRINDADE	07/12/2020 15:22	07/12/2020 18:56	07/12/2020 15:22	07/12/2020 18:56	3,56	147	523,93	CHI
20201234285	NIQUELANDIA	NQ21379787	NIQUELANDIA SUBTRANSMISSAO	07/12/2020 15:23	08/12/2020 09:56	07/12/2020 15:23	08/12/2020 09:56	18,55	1	18,55	CHI
20201234288	TRINDADE	10029438134	GOYA S2	07/12/2020 15:23	08/12/2020 08:40	07/12/2020 15:23	08/12/2020 08:40	17,27	1	17,27	CHI
20201234289	PIRACANJUBA	6416985	PIRACANJUBA	07/12/2020 15:23	08/12/2020 11:56	07/12/2020 15:23	08/12/2020 11:56	20,54	2	41,08	CHI
20201234304	SANTO ANTONIO DO DESCOBERTO	SN21313583	MARAJOARA	07/12/2020 15:24	07/12/2020 15:44	07/12/2020 15:24	07/12/2020 15:44	0,32	2	0,65	CHI
20201234296	CALDAS NOVAS	CN21318995	CALDAS NOVAS S1	07/12/2020 15:25	07/12/2020 21:47	07/12/2020 15:25	07/12/2020 21:47	6,37	1	6,37	CHI
20201234308	MONTIVIDIU	MV12267614B	MONTIVIDIU T	07/12/2020 15:27	08/12/2020 09:45	07/12/2020 15:27	08/12/2020 09:45	18,29	4	73,18	CHI
20201234316	JATAI	290124724	JATAI S2	07/12/2020 15:28	08/12/2020 12:12	07/12/2020 15:28	08/12/2020 12:12	20,73	1	20,73	CHI
20201234318	GOIAS	GS12021056RE	GOIAS	07/12/2020 15:28	07/12/2020 17:34	07/12/2020 15:28	07/12/2020 17:34	2,09	27	56,36	CHI
20201234323	NOVA AMERICA	NM21188995	RUBIATABA	07/12/2020 15:30	07/12/2020 23:49	07/12/2020 15:30	07/12/2020 23:49	8,32	1	8,32	CHI
20201234326	BURITI ALEGRE	BG12066320LD	GOIATUBA S2	07/12/2020 15:30	07/12/2020 20:06	07/12/2020 15:30	07/12/2020 20:06	4,59	3	13,77	CHI
20201234326	GOIATUBA	BG12066320LD	GOIATUBA S2	07/12/2020 15:30	07/12/2020 20:06	07/12/2020 15:30	07/12/2020 20:06	4,59	1	4,59	CHI
20201234327	SAO DOMINGOS	SD11164665	SAO DOMINGOS	07/12/2020 15:30	07/12/2020 19:04	07/12/2020 15:30	07/12/2020 19:04	3,56	6	21,34	CHI
20201234346	COLINAS DO SUL	TI1215523RE	MINACU	07/12/2020 15:32	07/12/2020 21:17	07/12/2020 15:32	07/12/2020 21:17	5,74	18	103,36	CHI
20201234348	QUIRINOPOLIS	QI21015002	QUIRINOPOLIS	07/12/2020 15:32	07/12/2020 16:39	07/12/2020 15:32	07/12/2020 16:39	1,10	1	1,10	CHI
20201234351	POSSE	PS21124636	IACIARA S2	07/12/2020 15:32	07/12/2020 19:01	07/12/2020 15:32	07/12/2020 19:01	3,47	1	3,47	CHI
20201234354	UIRAPURU	UP21222123	NOVA CRIXAS	07/12/2020 15:33	07/12/2020 21:23	07/12/2020 15:33	07/12/2020 21:23	5,83	1	5,83	CHI
20201234355	ANAPOLIS	21089050	JUNDIAI S1	07/12/2020 15:33	07/12/2020 22:21	07/12/2020 15:33	07/12/2020 22:21	6,79	1	6,79	CHI
20201234360	FLORES DE GOIAS	1510024727	IACIARA S2	07/12/2020 15:34	08/12/2020 00:14	07/12/2020 15:34	08/12/2020 00:14	8,66	1	8,66	CHI
20201234361	APARECIDA DE GOIANIA	200102783	INDEPENDENCIA S2	07/12/2020 15:34	07/12/2020 18:24	07/12/2020 15:34	07/12/2020 18:24	2,82	1	2,82	CHI
20201234373	APARECIDA DE GOIANIA	13528087	INDEPENDENCIA S2	07/12/2020 15:36	07/12/2020 17:02	07/12/2020 15:36	07/12/2020 17:02	1,43	1	1,43	CHI
20201234378	MONTES CLAROS DE GOIAS	ME21357460	IPORA	07/12/2020 15:37	08/12/2020 15:59	07/12/2020 15:37	08/12/2020 15:59	24,36	1	24,36	CHI
20201235057	FORMOSA	FA12359113	ITUIQUIRA	07/12/2020 15:37	07/12/2020 21:27	07/12/2020 15:37	07/12/2020 21:27	5,82	12	69,81	CHI
20201234387	SANTA CRUZ DE GOIAS	BC31266815	CRISTIANOPOLIS	07/12/2020 15:38	07/12/2020 17:23	07/12/2020 15:38	07/12/2020 17:23	1,73	6	10,41	CHI
20201234388	RIO VERDE	RV21214086	CABRIUVA S2	07/12/2020 15:39	07/12/2020 20:49	07/12/2020 15:39	07/12/2020 20:49	5,16	1	5,16	CHI
20201234391	ADELANDIA	1310033666	FIRMINOPOLIS S2	07/12/2020 15:39	07/12/2020 17:47	07/12/2020 15:39	07/12/2020 17:47	2,14	1	2,14	CHI
20201234392	CACU	CC21271665	CACHOEIRA ALTA	07/12/2020 15:39	07/12/2020 23:11	07/12/2020 15:39	07/12/2020 23:11	7,53	1	7,53	CHI
20201234394	DOVERLANDIA	DV21094709	CAIAPONIA	07/12/2020 15:40	07/12/2020 21:52	07/12/2020 15:40	07/12/2020 21:52	6,20	1	6,20	CHI
20201234397	ARUANA	AK13274213	ARUANA	07/12/2020 15:40	08/12/2020 00:46	07/12/2020 21:09	07/12/2020 21:37	0,47	132	62,04	CHI
20201234397	ARUANA	AK13416770B	ARUANA	07/12/2020 15:40	08/12/2020 00:46	07/12/2020 21:09	08/12/2020 00:46	3,62	237	857,48	CHI
20201234398	QUIRINOPOLIS	QI12198335	QUIRINOPOLIS	07/12/2020 15:41	07/12/2020 18:01	07/12/2020 15:41	07/12/2020 18:01	2,33	3	7,00	CHI
20201234399	FORMOSO	FO11000012	PORANGATU	07/12/2020 15:41	07/12/2020 19:46	07/12/2020 15:41	07/12/2020 19:46	4,08	87	355,03	CHI
20201234402	ALOANDIA	650001163	GOIATUBA S1	07/12/2020 15:41	07/12/2020 19:11	07/12/2020 15:41	07/12/2020 19:11	3,49	1	3,49	CHI
20201234434	MONTES CLAROS DE GOIAS	ME12251375	IPORA	07/12/2020 15:42	07/12/2020 23:27	07/12/2020 15:42	07/12/2020 23:27	7,73	7	54,14	CHI
20201234434	BOM JARDIM DE GOIAS	ME12251375	IPORA	07/12/2020 15:42	07/12/2020 23:27	07/12/2020 15:42	07/12/2020 23:27	7,73	18	139,21	CHI
20201234409	PARAUNA	980014840	PARAUNA	07/12/2020 15:43	08/12/2020 09:42	07/12/2020 15:43	08/12/2020 09:42	17,97	1	17,97	CHI
20201234413	GOIANIRA	390028897	GOIANIRA	07/12/2020 15:44	07/12/2020 17:36	07/12/2020 15:44	07/12/2020 17:36	1,86	1	1,86	CHI
20201234418	QUIRINOPOLIS	QI12326606	CACHOEIRA ALTA	07/12/2020 15:45	07/12/2020 19:16	07/12/2020 15:45	07/12/2020 19:16	3,51	1	3,51	CHI
20201234420	VALPARAISO DE GOIAS	10008283190	PACAEMBU S2	07/12/2020 15:45	07/12/2020 16:25	07/12/2020 15:45	07/12/2020 16:25	0,67	1	0,67	CHI
20201234422	EDEIA	VI12381144	VICENTINOPOLIS	07/12/2020 15:45	07/12/2020 19:10	07/12/2020 15:45	07/12/2020 19:10	3,41	1	3,41	CHI

20201234422	VICENTINOPOLIS	VI12381144	VICENTINOPOLIS	07/12/2020 15:45	07/12/2020 19:10	07/12/2020 15:45	07/12/2020 19:10	3,41	2	6,81	CHI
20201234669	FORMOSA	FA12383272	ITIQUEIRA	07/12/2020 15:45	07/12/2020 23:06	07/12/2020 15:45	07/12/2020 23:06	7,34	39	286,08	CHI
20201234425	GOIANIA	10029978082	TRINDADE	07/12/2020 15:47	08/12/2020 04:05	07/12/2020 15:47	08/12/2020 04:05	12,30	1	12,30	CHI
20201234431	CRISTALINA	KR21304914	CRISTALINA S2	07/12/2020 15:48	07/12/2020 19:06	07/12/2020 15:48	07/12/2020 19:06	3,29	1	3,29	CHI
20201234433	VIANOPOLIS	VN21159679	PIRES DO RIO S2	07/12/2020 15:48	07/12/2020 19:17	07/12/2020 15:48	07/12/2020 19:17	3,48	1	3,48	CHI
20201234436	APARECIDA DE GOIANIA	200509226	INDEPENDENCIA S2	07/12/2020 15:49	07/12/2020 17:49	07/12/2020 15:49	07/12/2020 17:49	2,00	1	2,00	CHI
20201234444	COLINAS DO SUL	TI21197706	MINACU	07/12/2020 15:49	07/12/2020 20:36	07/12/2020 15:49	07/12/2020 20:36	4,77	1	4,77	CHI
20201234478	ALEXANIA	AX11200582	ALEXANIA	07/12/2020 15:49	07/12/2020 20:10	07/12/2020 15:49	07/12/2020 20:10	4,35	167	725,89	CHI
20201235010	CORUMBAIBA	MG12000356	VILA CORUMBA	07/12/2020 15:49	08/12/2020 08:06	07/12/2020 15:49	08/12/2020 08:06	16,27	6	97,64	CHI
20201234452	MUNDO NOVO DE GOIAS	4240001457	NOVA CRIXAS	07/12/2020 15:51	07/12/2020 23:21	07/12/2020 15:51	07/12/2020 23:21	7,49	1	7,49	CHI
20201234454	APARECIDA DE GOIANIA	200108955	INDEPENDENCIA S1	07/12/2020 15:52	07/12/2020 20:42	07/12/2020 15:52	07/12/2020 20:42	4,83	1	4,83	CHI
20201234455	APARECIDA DE GOIANIA	10001852173	INDEPENDENCIA S2	07/12/2020 15:52	07/12/2020 20:34	07/12/2020 15:52	07/12/2020 20:34	4,70	1	4,70	CHI
20201234456	NIQUELANDIA	NQ12342810LD	URUACU	07/12/2020 15:52	07/12/2020 20:12	07/12/2020 15:52	07/12/2020 20:12	4,33	7	30,30	CHI
20201234492	ALEXANIA	AX11200569	ALEXANIA	07/12/2020 15:52	07/12/2020 20:43	07/12/2020 15:52	07/12/2020 20:43	4,83	67	323,91	CHI
20201234460	GOIANIA	12355409	GOYA S2	07/12/2020 15:53	07/12/2020 22:29	07/12/2020 15:53	07/12/2020 22:29	6,60	1	6,60	CHI
20201234465	PETROLINA DE GOIAS	PG21111290	PETROLINA	07/12/2020 15:54	08/12/2020 14:33	07/12/2020 15:54	08/12/2020 14:33	22,65	2	45,29	CHI
20201234466	PLANALTINA	10017701153	PLANALTINA	07/12/2020 15:54	07/12/2020 18:04	07/12/2020 15:54	07/12/2020 18:04	2,16	1	2,16	CHI
20201234470	NAZARIO	NZ12040406	ANICUNS	07/12/2020 15:55	07/12/2020 18:02	07/12/2020 15:55	07/12/2020 18:02	2,11	1	2,11	CHI
20201234477	URUACU	UR21141811	URUACU	07/12/2020 15:56	07/12/2020 19:20	07/12/2020 15:56	07/12/2020 19:20	3,39	1	3,39	CHI
20201234481	PORANGATU	840136500	PORANGATU	07/12/2020 15:57	08/12/2020 05:25	07/12/2020 15:57	08/12/2020 05:25	13,47	1	13,47	CHI
20201234483	CUMARI	CY21000510	CATALAO S1	07/12/2020 15:57	08/12/2020 00:11	07/12/2020 15:57	08/12/2020 00:11	8,22	1	8,22	CHI
20201234485	PORANGATU	PO12047528RE	PORANGATU	07/12/2020 15:57	08/12/2020 13:00	07/12/2020 15:57	08/12/2020 13:00	21,04	27	567,96	CHI
20201234487	GOIANIA	GN11002595	CAMPINAS S2	07/12/2020 15:57	07/12/2020 16:50	07/12/2020 15:57	07/12/2020 16:50	0,87	151	132,00	CHI
20201234489	ITUMBARA	IT12047782	CACHOEIRA DOURADA	07/12/2020 15:58	08/12/2020 11:04	07/12/2020 15:58	08/12/2020 11:04	19,09	2	38,18	CHI
20201234490	LEOPOLDO DE BULHOES	SW12217284	CEPAIGO S2	07/12/2020 15:58	07/12/2020 17:34	07/12/2020 15:58	07/12/2020 17:34	1,59	53	84,06	CHI
20201234490	CALDAZINHA	SW12217284	CEPAIGO S2	07/12/2020 15:58	07/12/2020 17:34	07/12/2020 15:58	07/12/2020 17:34	1,59	5	7,93	CHI
20201234493	PORANGATU	PO21172410	PORANGATU	07/12/2020 15:59	07/12/2020 17:06	07/12/2020 15:59	07/12/2020 17:06	1,11	1	1,11	CHI
20201234498	APARECIDA DE GOIANIA	10002518048	CARAJAS S1	07/12/2020 16:00	07/12/2020 18:19	07/12/2020 16:00	07/12/2020 18:19	2,31	1	2,31	CHI
20201234502	URUACU	10032800671	URUACU	07/12/2020 16:00	07/12/2020 22:10	07/12/2020 16:00	07/12/2020 22:10	6,15	1	6,15	CHI
20201234503	HIDROLANDIA	HD21030264	CEPAIGO S2	07/12/2020 16:00	08/12/2020 04:42	07/12/2020 16:00	08/12/2020 04:42	12,68	1	12,68	CHI
20201234505	SENADOR CANEDO	10033113147	SENADOR CANEDO	07/12/2020 16:01	07/12/2020 17:29	07/12/2020 16:01	07/12/2020 17:29	1,46	0	0,00	CHI
20201234506	GAUPO	GA21032857	GUAPO S2	07/12/2020 16:01	08/12/2020 02:32	07/12/2020 16:01	08/12/2020 02:32	10,51	1	10,51	CHI
20201234516	URUACU	10001099556	URUACU	07/12/2020 16:02	07/12/2020 20:45	07/12/2020 16:02	07/12/2020 20:45	4,70	1	4,70	CHI
20201234520	APARECIDA DE GOIANIA	12720987	INDEPENDENCIA S2	07/12/2020 16:03	07/12/2020 17:20	07/12/2020 16:03	07/12/2020 17:20	1,27	1	1,27	CHI
20201234536	GOIANIA	12820957	ATLANTICO S2	07/12/2020 16:07	07/12/2020 16:44	07/12/2020 16:07	07/12/2020 16:44	0,61	1	0,61	CHI
20201234544	CABECEIRAS	CW12108823	ITIQUEIRA	07/12/2020 16:09	07/12/2020 17:36	07/12/2020 16:09	07/12/2020 17:36	1,44	8	11,49	CHI
20201234553	ITAUCU	110024310	INHUMAS S1	07/12/2020 16:14	07/12/2020 20:38	07/12/2020 16:14	07/12/2020 20:38	4,39	1	4,39	CHI
20201234556	GOIANIA	GN11000651	ATLANTICO S2	07/12/2020 16:14	07/12/2020 17:43	07/12/2020 16:14	07/12/2020 17:43	1,47	32	46,96	CHI
20201234558	CRISTIANOPOLIS	CF21107170	CRISTIANOPOLIS	07/12/2020 16:15	07/12/2020 18:28	07/12/2020 16:15	07/12/2020 18:28	2,21	1	2,21	CHI
20201234560	APARECIDA DE GOIANIA	200657732	INDEPENDENCIA S1	07/12/2020 16:15	07/12/2020 18:36	07/12/2020 16:15	07/12/2020 18:36	2,34	1	2,34	CHI
20201234577	ABADIA DE GOIAS	10028010530	CARAJAS S2	07/12/2020 16:18	08/12/2020 04:45	07/12/2020 16:18	08/12/2020 04:45	12,44	1	12,44	CHI
20201234583	GOIANIA	10272549	CAMPINAS S3	07/12/2020 16:20	07/12/2020 19:13	07/12/2020 16:20	07/12/2020 19:13	2,88	1	2,88	CHI
20201234584	MAMBAI	MB11161460	IACIARA S2	07/12/2020 16:20	07/12/2020 18:23	07/12/2020 16:20	07/12/2020 18:23	2,05	3	6,14	CHI
20201234588	FAINA	IK12308282	GOIAS	07/12/2020 16:21	07/12/2020 22:19	07/12/2020 16:21	07/12/2020 22:19	5,96	1	5,96	CHI
20201234589	RIO VERDE	RV12213467LD	RIO VERDE S1	07/12/2020 16:21	07/12/2020 19:17	07/12/2020 16:21	07/12/2020 19:17	2,92	1	2,92	CHI
20201234592	LUZIANIA	120230562	RIO VERMELHO	07/12/2020 16:21	07/12/2020 22:40	07/12/2020 16:21	07/12/2020 22:40	6,30	1	6,30	CHI
20201234595	GOIANIRA	GR21016197	GOIANIRA	07/12/2020 16:22	07/12/2020 21:36	07/12/2020 16:22	07/12/2020 21:36	5,22	3	15,67	CHI
20201234598	RUBIATABA	RB21114303	RUBIATABA	07/12/2020 16:24	08/12/2020 07:54	07/12/2020 16:24	08/12/2020 07:54	15,50	1	15,50	CHI
20201234600	ITABERAI	50052111	ITABERAI S2	07/12/2020 16:24	07/12/2020 18:01	07/12/2020 16:24	07/12/2020 18:01	1,60	1	1,60	CHI
20201235628	ARAGARCAS	AG12381009	ARAGARCAS	07/12/2020 16:24	08/12/2020 08:44	07/12/2020 16:24	08/12/2020 08:44	16,32	9	146,92	CHI
20201234604	ABADIA DE GOIAS	10025149634	INDEPENDENCIA S2	07/12/2020 16:26	08/12/2020 10:43	07/12/2020 16:26	08/12/2020 10:43	18,27	1	18,27	CHI

20201234607	FAINA	FC12147803	GOIAS	07/12/2020 16:27	07/12/2020 18:14	07/12/2020 16:27	07/12/2020 18:14	1,78	4	7,12	CHI
20201234609	MARA ROSA	CR12000060RE	CAMPINORTE	07/12/2020 16:27	07/12/2020 17:36	07/12/2020 16:27	07/12/2020 17:36	1,14	1	1,14	CHI
20201234609	CAMPINORTE	CR12000060RE	CAMPINORTE	07/12/2020 16:27	07/12/2020 17:36	07/12/2020 16:27	07/12/2020 17:36	1,14	9	10,28	CHI
20201234609	NOVA IGUACU DE GOIAS	CR12000060RE	CAMPINORTE	07/12/2020 16:27	07/12/2020 17:36	07/12/2020 16:27	07/12/2020 17:36	1,14	108	123,36	CHI
20201234610	SANTO ANTONIO DO DESCOBERTO	SN12261733	MARAJOARA	07/12/2020 16:27	07/12/2020 22:03	07/12/2020 16:27	07/12/2020 22:03	5,60	11	61,60	CHI
20201234613	SANTA HELENA DE GOIAS	400007290	IPEGUARI	07/12/2020 16:28	08/12/2020 00:47	07/12/2020 16:28	08/12/2020 00:47	8,30	1	8,30	CHI
20201234801	NOVA AURORA	NE12078800	CATALAO S1	07/12/2020 16:30	07/12/2020 19:50	07/12/2020 16:30	07/12/2020 19:50	3,32	4	13,29	CHI
20201234801	IPAMERI	NE12078800	CATALAO S1	07/12/2020 16:30	07/12/2020 19:50	07/12/2020 16:30	07/12/2020 19:50	3,32	1	3,32	CHI
20201234625	BELA VISTA DE GOIAS	BV12185857	CEPAIGO S2	07/12/2020 16:31	07/12/2020 20:27	07/12/2020 16:31	07/12/2020 20:27	3,92	3	11,75	CHI
20201234631	CRIXAS	CX12285665	SERRA DO OURO	07/12/2020 16:32	07/12/2020 21:58	07/12/2020 16:32	07/12/2020 21:58	5,42	2	10,83	CHI
20201234636	MORRINHOS	150101790	MORRINHOS	07/12/2020 16:33	07/12/2020 20:42	07/12/2020 16:33	07/12/2020 20:42	4,14	1	4,14	CHI
20201234637	JATAI	JT21103997	JATAI S3	07/12/2020 16:33	08/12/2020 12:14	07/12/2020 16:33	08/12/2020 12:14	19,67	1	19,67	CHI
20201234639	CORUMBA DE GOIAS	CB21297658	CORUMBA	07/12/2020 16:34	08/12/2020 02:02	07/12/2020 16:34	08/12/2020 02:02	9,46	1	9,46	CHI
20201234641	QUIRINOPOLIS	QI21103416	QUIRINOPOLIS	07/12/2020 16:34	07/12/2020 19:22	07/12/2020 16:34	07/12/2020 19:22	2,79	1	2,79	CHI
20201234645	QUIRINOPOLIS	QI31249039	QUIRINOPOLIS	07/12/2020 16:36	07/12/2020 19:44	07/12/2020 16:36	07/12/2020 19:44	3,13	1	3,13	CHI
20201234649	APARECIDA DE GOIANIA	14044882	ATLANTICO S1	07/12/2020 16:36	08/12/2020 04:27	07/12/2020 16:36	08/12/2020 04:27	11,84	1	11,84	CHI
20201234651	ANAPOLIS	20007917	ANAPOLIS UNIVERSITARIO S2	07/12/2020 16:37	07/12/2020 19:52	07/12/2020 16:37	07/12/2020 19:52	3,24	1	3,24	CHI
20201234653	IPORA	730061334	IPORA	07/12/2020 16:38	08/12/2020 19:08	07/12/2020 16:38	08/12/2020 19:08	26,50	1	26,50	CHI
20201234655	BELA VISTA DE GOIAS	BV12031906	BELA VISTA S1	07/12/2020 16:38	07/12/2020 17:51	07/12/2020 16:38	07/12/2020 17:51	1,21	1	1,21	CHI
20201235515	ACREUNA	EU12000195	ACREUNA	07/12/2020 16:39	08/12/2020 16:27	07/12/2020 16:39	08/12/2020 16:27	23,81	8	190,45	CHI
20201234662	UIRAPURU	UP21237762	SANTA TEREZINHA	07/12/2020 16:40	07/12/2020 22:46	07/12/2020 16:40	07/12/2020 22:46	6,10	1	6,10	CHI
20201234663	CATALAO	CT21231544	CATALAO S1	07/12/2020 16:41	07/12/2020 19:16	07/12/2020 16:41	07/12/2020 19:16	2,58	1	2,58	CHI
20201234664	CRIXAS	CX12055157	SERRA DO OURO	07/12/2020 16:41	08/12/2020 00:04	07/12/2020 16:41	08/12/2020 00:04	7,39	8	59,16	CHI
20201234666	FLORES DE GOIAS	FB12252148	FLORES DE GOIAS	07/12/2020 16:41	09/12/2020 21:12	07/12/2020 16:41	09/12/2020 21:12	52,50	10	525,02	CHI
20201235438	ACREUNA	EU12301173	ACREUNA	07/12/2020 16:42	08/12/2020 13:42	07/12/2020 16:42	08/12/2020 13:42	21,00	11	230,99	CHI
20201234675	RIO VERDE	RV12260695	CABRIUVA S1	07/12/2020 16:43	08/12/2020 00:45	07/12/2020 16:43	08/12/2020 00:45	8,02	12	96,22	CHI
20201234678	IPAMERI	KR21249276	CRISTALINA S2	07/12/2020 16:45	07/12/2020 22:27	07/12/2020 16:45	07/12/2020 22:27	5,69	1	5,69	CHI
20201234683	NOVO GAMA	NJ21246134	PACAEMBU S2	07/12/2020 16:47	07/12/2020 23:50	07/12/2020 16:47	07/12/2020 23:50	7,04	2	14,09	CHI
20201234695	COCALZINHO DE GOIAS	ZN21217595	AGUAS LINDAS DE GOIAS S2	07/12/2020 16:50	07/12/2020 18:38	07/12/2020 16:50	07/12/2020 18:38	1,79	1	1,79	CHI
20201234696	OUVIDOR	2180019252	CATALAO S1	07/12/2020 16:50	07/12/2020 18:03	07/12/2020 16:50	07/12/2020 18:03	1,21	1	1,21	CHI
20201236086	SITIO D ABADIA	FB12277896	IACIARA S2	07/12/2020 16:50	09/12/2020 11:04	07/12/2020 16:50	09/12/2020 11:04	42,23	20	844,61	CHI
20201236086	FLORES DE GOIAS	FB12277896	IACIARA S2	07/12/2020 16:50	09/12/2020 11:04	07/12/2020 16:50	09/12/2020 11:04	42,23	3	126,69	CHI
20201234702	SIMOLANDIA	SA12246944	IACIARA S2	07/12/2020 16:51	07/12/2020 19:13	07/12/2020 16:51	07/12/2020 19:13	2,35	1	2,35	CHI
20201234703	ITAGUARI	770019213	ITABERAI S1	07/12/2020 16:52	08/12/2020 07:02	07/12/2020 16:52	08/12/2020 07:02	14,15	1	14,15	CHI
20201234706	SAO JOAO D ALIANCA	JL11280297	SAO JOAO D ALIANCA	07/12/2020 16:52	07/12/2020 18:39	07/12/2020 16:52	07/12/2020 18:39	1,77	9	15,91	CHI
20201234765	MINEIROS	DJ10418274	CHAPADAO DO CEU	07/12/2020 16:52	07/12/2020 17:07	07/12/2020 16:52	07/12/2020 17:07	0,24	20	4,87	CHI
20201234765	SERRANOPOLIS	DJ10418274	CHAPADAO DO CEU	07/12/2020 16:52	07/12/2020 17:07	07/12/2020 16:52	07/12/2020 17:07	0,24	50	12,18	CHI
20201234714	LUZIANIA	120181538	RIO VERMELHO	07/12/2020 16:55	07/12/2020 21:41	07/12/2020 16:55	07/12/2020 21:41	4,77	1	4,77	CHI
20201234715	RIO VERDE	RV21260880	CABRIUVA S2	07/12/2020 16:55	07/12/2020 18:59	07/12/2020 16:55	07/12/2020 18:59	2,05	1	2,05	CHI
20201234944	GOIAS	GS13220398	ITABERAI S1	07/12/2020 16:55	07/12/2020 22:07	07/12/2020 16:55	07/12/2020 22:07	5,20	173	899,74	CHI
20201234944	ITABERAI	GS13220398	ITABERAI S1	07/12/2020 16:55	07/12/2020 22:07	07/12/2020 16:55	07/12/2020 22:07	5,20	3	15,60	CHI
20201234718	CRIXAS	CX21280651	RUBIATABA	07/12/2020 16:56	08/12/2020 12:16	07/12/2020 16:56	08/12/2020 12:16	19,32	1	19,32	CHI
20201234721	IPAMERI	IP21158139	CRISTALINA S2	07/12/2020 16:57	07/12/2020 23:08	07/12/2020 16:57	07/12/2020 23:08	6,18	1	6,18	CHI
20201234722	PIRENOPOLIS	ZN21258988	COCALZINHO	07/12/2020 16:57	08/12/2020 12:05	07/12/2020 16:57	08/12/2020 12:05	19,13	1	19,13	CHI
20201234727	SANTA RITA DO NOVO DESTINO	BA21199775	BARRO ALTO	07/12/2020 16:57	07/12/2020 23:16	07/12/2020 16:57	07/12/2020 23:16	6,31	1	6,31	CHI
20201234760	CABECEIRAS	CW12108845	ITUIQUIRA	07/12/2020 16:58	07/12/2020 18:58	07/12/2020 16:58	07/12/2020 18:58	1,99	11	21,84	CHI
20201234763	IPAMERI	IP21195246	IPAMERI	07/12/2020 16:59	07/12/2020 18:59	07/12/2020 16:59	07/12/2020 18:59	1,99	1	1,99	CHI
20201234771	GOIANESIA	550008068	GOIANESIA S2	07/12/2020 16:59	07/12/2020 19:12	07/12/2020 16:59	07/12/2020 19:12	2,20	1	2,20	CHI
20201234810	SAO DOMINGOS	SD12384774	SAO DOMINGOS	07/12/2020 16:59	07/12/2020 19:39	07/12/2020 16:59	07/12/2020 19:39	2,65	84	222,93	CHI
20201234775	FORMOSA	610077478	ITUIQUIRA	07/12/2020 17:00	08/12/2020 12:11	07/12/2020 17:00	08/12/2020 12:11	19,18	1	19,18	CHI
20201234780	CRIXAS	CX21304124	SANTA TEREZINHA	07/12/2020 17:01	08/12/2020 05:23	07/12/2020 17:01	08/12/2020 05:23	12,35	1	12,35	CHI

20201234850	SILVANIA	SV12102994	VIANOPOLIS	07/12/2020 17:01	07/12/2020 19:18	07/12/2020 17:01	07/12/2020 19:18	2,27	76	172,73	CHI
20201234850	VIANOPOLIS	SV12102994	VIANOPOLIS	07/12/2020 17:01	07/12/2020 19:18	07/12/2020 17:01	07/12/2020 19:18	2,27	118	268,19	CHI
20201234850	SAO MIGUEL DO PASSA QUATRO	SV12102994	VIANOPOLIS	07/12/2020 17:01	07/12/2020 19:18	07/12/2020 17:01	07/12/2020 19:18	2,27	62	140,91	CHI
20201234788	SAO MIGUEL DO PASSA QUATRO	SQ12373971	BELA VISTA S2	07/12/2020 17:03	08/12/2020 10:09	07/12/2020 17:03	08/12/2020 10:09	17,10	2	34,19	CHI
20201234789	GUARANI DE GOIAS	GY21211245	SAO DOMINGOS	07/12/2020 17:03	08/12/2020 08:26	07/12/2020 17:03	08/12/2020 08:26	15,38	2	30,75	CHI
20201234795	GOIANIRA	GR21016143	GOIANIRA	07/12/2020 17:04	08/12/2020 00:49	07/12/2020 17:04	08/12/2020 00:49	7,74	3	23,23	CHI
20201235249	SANTO ANTONIO DO DESCOBERTO	SN12382973	MARAJOARA	07/12/2020 17:04	07/12/2020 23:38	07/12/2020 17:04	07/12/2020 23:38	6,56	5	32,82	CHI
20201234804	APARECIDA DE GOIANIA	AP11003011	ANHANGUERA	07/12/2020 17:05	07/12/2020 18:54	07/12/2020 17:05	07/12/2020 18:54	1,81	31	56,00	CHI
20201235106	ALOANDIA	AD12293139	GOIATUBA S1	07/12/2020 17:06	07/12/2020 19:21	07/12/2020 17:06	07/12/2020 19:21	2,24	7	15,65	CHI
20201235106	PONTALINA	AD12293139	GOIATUBA S1	07/12/2020 17:06	07/12/2020 19:21	07/12/2020 17:06	07/12/2020 19:21	2,24	1	2,24	CHI
20201234823	TRINDADE	TR11193147	TRINDADE	07/12/2020 17:07	07/12/2020 21:59	07/12/2020 17:07	07/12/2020 21:59	4,86	93	452,08	CHI
20201234814	GOIANIA	GN12222884	XAVANTES	07/12/2020 17:08	07/12/2020 18:03	07/12/2020 17:08	07/12/2020 18:03	0,91	42	38,43	CHI
20201234815	ITARUMA	IM21296652	CACHOEIRA ALTA	07/12/2020 17:08	07/12/2020 19:19	07/12/2020 17:08	07/12/2020 19:19	2,18	1	2,18	CHI
20201234818	FAINA	FC21123774	GOIAS	07/12/2020 17:08	08/12/2020 11:43	07/12/2020 17:08	08/12/2020 11:43	18,57	1	18,57	CHI
20201234821	PIRES DO RIO	PR12231317	PIRES DO RIO S1	07/12/2020 17:09	07/12/2020 22:49	07/12/2020 17:09	07/12/2020 22:49	5,65	12	67,82	CHI
20201234826	PARAUNA	PU21350904	PARAUNA	07/12/2020 17:11	08/12/2020 11:53	07/12/2020 17:11	08/12/2020 11:53	18,70	1	18,70	CHI
20201234830	CALDAS NOVAS	CN12404748	CALDAS NOVAS S1	07/12/2020 17:11	07/12/2020 19:10	07/12/2020 17:11	07/12/2020 19:10	1,98	6	11,86	CHI
20201234830	RIO QUENTE	CN12404748	CALDAS NOVAS S1	07/12/2020 17:11	07/12/2020 19:10	07/12/2020 17:11	07/12/2020 19:10	1,98	41	81,05	CHI
20201234832	GOIANIA	16557608	XAVANTES	07/12/2020 17:11	07/12/2020 18:40	07/12/2020 17:11	07/12/2020 18:40	1,48	1	1,48	CHI
20201234839	GOIANIA	GN12210953	ATLANTICO S2	07/12/2020 17:11	07/12/2020 18:36	07/12/2020 17:11	07/12/2020 18:36	1,40	2	2,81	CHI
20201234849	FLORES DE GOIAS	FB21423501	FLORES DE GOIAS	07/12/2020 17:15	09/12/2020 11:19	07/12/2020 17:15	09/12/2020 11:19	42,06	1	42,06	CHI
20201230764	JUSSARA	JR12124817	BRITANIA	07/12/2020 17:17	08/12/2020 18:13	07/12/2020 17:17	08/12/2020 18:13	24,93	11	274,22	CHI
20201234854	PLANALTINA	PI12248809	PLANALTINA	07/12/2020 17:17	07/12/2020 23:37	07/12/2020 17:17	07/12/2020 23:37	6,33	5	31,66	CHI
20201234855	MORRO AGUDO DE GOIAS	MS21185169	ITAPURANGA	07/12/2020 17:17	07/12/2020 22:15	07/12/2020 17:17	07/12/2020 22:15	4,96	1	4,96	CHI
20201234859	SANTO ANTONIO DO DESCOBERTO	2210111931	ALEXANIA	07/12/2020 17:18	07/12/2020 18:51	07/12/2020 17:18	07/12/2020 18:51	1,55	1	1,55	CHI
20201234860	FORMOSA	FA21120042	ITUIQUIRA	07/12/2020 17:18	07/12/2020 22:07	07/12/2020 17:18	07/12/2020 22:07	4,81	2	9,63	CHI
20201234864	LEOPOLDO DE BULHOES	LB12000010	DAIA S2	07/12/2020 17:18	07/12/2020 20:45	07/12/2020 17:18	07/12/2020 20:45	3,44	10	34,39	CHI
20201234865	APARECIDA DE GOIANIA	200545668	INDEPENDENCIA S2	07/12/2020 17:18	07/12/2020 20:56	07/12/2020 17:18	07/12/2020 20:56	3,62	1	3,62	CHI
20201234867	CRISTALINA	KR11287413	CRISTALINA S1	07/12/2020 17:19	08/12/2020 00:35	07/12/2020 17:19	08/12/2020 00:35	7,26	5	36,31	CHI
20201234907	MOSSAMEDES	MD12000176	FIRMINOPOLIS S2	07/12/2020 17:21	07/12/2020 18:51	07/12/2020 17:21	07/12/2020 18:51	1,48	37	54,89	CHI
20201234908	TAQUARAL DE GOIAS	TQ21019114	INHUMAS S1	07/12/2020 17:22	08/12/2020 17:15	07/12/2020 17:22	08/12/2020 17:15	23,88	1	23,88	CHI
20201234911	LEOPOLDO DE BULHOES	LB12028215	DAIA S2	07/12/2020 17:23	07/12/2020 23:34	07/12/2020 17:23	07/12/2020 23:34	6,18	6	37,07	CHI
20201234914	RIO VERDE	RV21074160	MONTIVIDIU T	07/12/2020 17:23	07/12/2020 23:29	07/12/2020 17:23	07/12/2020 23:29	6,09	2	12,17	CHI
20201234920	CACU	CC21264172LD	CACHOEIRA ALTA	07/12/2020 17:25	07/12/2020 18:26	07/12/2020 17:25	07/12/2020 18:26	1,00	85	85,02	CHI
20201235958	MINEIROS	MY21324736	PARQUE DAS EMAS	07/12/2020 17:25	08/12/2020 00:03	07/12/2020 17:25	08/12/2020 00:03	6,63	1	6,63	CHI
20201234921	RIO VERDE	RV11360715	RIO VERDE S2	07/12/2020 17:26	07/12/2020 18:37	07/12/2020 17:26	07/12/2020 18:37	1,18	107	126,44	CHI
20201234924	CRISTALINA	KR21165872	CRISTALINA S2	07/12/2020 17:26	07/12/2020 22:50	07/12/2020 17:26	07/12/2020 22:50	5,38	1	5,38	CHI
20201234926	CALDAS NOVAS	CN11000033	CALDAS NOVAS S2	07/12/2020 17:27	07/12/2020 18:21	07/12/2020 17:27	07/12/2020 18:21	0,90	123	110,26	CHI
20201234929	MINEIROS	MY21324738	PARQUE DAS EMAS	07/12/2020 17:27	08/12/2020 02:11	07/12/2020 17:27	08/12/2020 02:11	8,73	1	8,73	CHI
20201235477	PIRANHAS	PH12245935	PIRANHAS	07/12/2020 17:27	08/12/2020 09:38	07/12/2020 17:27	08/12/2020 09:38	16,17	16	258,80	CHI
20201235670	SILVANIA	SV12107840	VIANOPOLIS	07/12/2020 17:27	08/12/2020 09:06	07/12/2020 17:27	08/12/2020 09:06	15,66	16	250,48	CHI
20201236084	PIRENOPOLIS	PV12381257	CORUMBA	07/12/2020 17:28	07/12/2020 23:54	07/12/2020 17:28	07/12/2020 23:54	6,42	131	841,02	CHI
20201234940	GOIANIA	40115306	MEIA PONTE	07/12/2020 17:30	08/12/2020 10:34	07/12/2020 17:30	08/12/2020 10:34	17,06	1	17,06	CHI
20201234942	TAQUARAL DE GOIAS	TQ12299894	ITABERAI S1	07/12/2020 17:30	08/12/2020 12:34	07/12/2020 20:41	07/12/2020 21:58	1,27	4	5,07	CHI
20201234942	TAQUARAL DE GOIAS	TQ21278353	ITABERAI S1	07/12/2020 17:30	08/12/2020 12:34	07/12/2020 17:30	08/12/2020 12:34	19,07	1	19,07	CHI
20201234948	GOIANIA	11733676	CAMPINAS S1	07/12/2020 17:32	07/12/2020 19:44	07/12/2020 17:32	07/12/2020 19:44	2,20	1	2,20	CHI
20201234949	SAO MIGUEL DO ARAGUAIA	SM21060023	SAO MIGUEL DO ARAGUAIA	07/12/2020 17:32	08/12/2020 11:25	07/12/2020 17:32	08/12/2020 11:25	17,87	1	17,87	CHI
20201234952	CACU	CC21227957	CACHOEIRA ALTA	07/12/2020 17:33	07/12/2020 19:00	07/12/2020 17:33	07/12/2020 19:00	1,44	1	1,44	CHI
20201235054	SAO MIGUEL DO ARAGUAIA	SM12212458	SAO MIGUEL DO ARAGUAIA	07/12/2020 17:33	08/12/2020 01:20	07/12/2020 17:33	08/12/2020 01:20	7,77	6	46,61	CHI
20201234957	GOUVELANDIA	GB12261016	QUIRINOPOLIS	07/12/2020 17:34	07/12/2020 20:55	07/12/2020 17:34	07/12/2020 20:55	3,35	5	16,74	CHI
20201234992	MINEIROS	MY12324417	PARQUE DAS EMAS	07/12/2020 17:35	07/12/2020 23:20	07/12/2020 17:35	07/12/2020 23:20	5,74	2	11,49	CHI

20201234991	MINEIROS	MY12043897	PARQUE DAS EMAS	07/12/2020 17:36	07/12/2020 23:06	07/12/2020 17:36	07/12/2020 23:06	5,49	27	148,26	CHI
20201235186	SAO MIGUEL DO ARAGUAIA	SM12013236	SAO MIGUEL DO ARAGUAIA	07/12/2020 17:36	07/12/2020 23:48	07/12/2020 17:36	07/12/2020 23:48	6,19	28	173,23	CHI
20201235084	CORUMBA DE GOIAS	CB11130884	CORUMBA	07/12/2020 17:37	07/12/2020 21:02	07/12/2020 17:37	07/12/2020 21:02	3,41	141	480,57	CHI
20201235622	CORUMBAIBA	CI12333281RE	VILA CORUMBA	07/12/2020 17:37	07/12/2020 23:48	07/12/2020 17:37	07/12/2020 23:48	6,18	119	735,62	CHI
20201234995	CATALAO	CT12278148	CATALAO S1	07/12/2020 17:41	07/12/2020 19:02	07/12/2020 17:41	07/12/2020 19:02	1,34	5	6,69	CHI
20201235003	PIRES DO RIO	PR21000413	PIRES DO RIO S1	07/12/2020 17:43	08/12/2020 02:04	07/12/2020 17:43	08/12/2020 02:04	8,34	1	8,34	CHI
20201236017	ARAGUAPAZ	AZ12336266	GOIAS	07/12/2020 17:43	08/12/2020 10:14	07/12/2020 17:43	08/12/2020 10:14	16,51	6	99,07	CHI
20201235008	ANAPOLIS	20296710	JUNDIAI S1	07/12/2020 17:44	07/12/2020 21:18	07/12/2020 17:44	07/12/2020 21:18	3,57	1	3,57	CHI
20201235011	GOUVELANDIA	GB31067502	QUIRINOPOLIS	07/12/2020 17:44	07/12/2020 22:32	07/12/2020 17:44	07/12/2020 22:32	4,79	1	4,79	CHI
20201235013	SAO JOAO D ALIANCA	FB21188741	IACIARA S2	07/12/2020 17:45	07/12/2020 22:07	07/12/2020 17:45	07/12/2020 22:07	4,36	1	4,36	CHI
20201235014	QUIRINOPOLIS	QI32094314	QUIRINOPOLIS	07/12/2020 17:45	07/12/2020 20:56	07/12/2020 17:45	07/12/2020 20:56	3,18	1	3,18	CHI
20201235025	GOIANIA	GN21000741	AEROPORTO S2	07/12/2020 17:47	07/12/2020 21:44	07/12/2020 19:40	07/12/2020 21:44	2,07	1	2,07	CHI
20201235072	BONOPOLIS	BX12165447	SAO MIGUEL DO ARAGUAIA	07/12/2020 17:47	07/12/2020 19:18	07/12/2020 17:47	07/12/2020 19:18	1,51	3	4,54	CHI
20201235465	DIORAMA	DI12066071	ARENOPOLIS	07/12/2020 17:49	08/12/2020 14:01	07/12/2020 17:49	08/12/2020 14:01	20,19	29	585,61	CHI
20201235036	ITUMBIARA	IT21305542	ITUMBIARA NOVA	07/12/2020 17:50	08/12/2020 13:27	07/12/2020 17:50	08/12/2020 13:27	19,63	1	19,63	CHI
20201235037	NOVA AURORA	2220000911	CATALAO S1	07/12/2020 17:50	07/12/2020 19:10	07/12/2020 17:50	07/12/2020 19:10	1,33	1	1,33	CHI
20201235040	FORMOSA	FA21428885	SAO JOAO D ALIANCA	07/12/2020 17:51	08/12/2020 19:30	07/12/2020 17:51	08/12/2020 19:30	25,66	1	25,66	CHI
20201235047	PLANALTINA	PI11357728	PLANALTINA	07/12/2020 17:53	07/12/2020 20:30	07/12/2020 17:53	07/12/2020 20:30	2,61	1	2,61	CHI
20201235050	PALESTINA DE GOIAS	PY21043011	PALESTINA	07/12/2020 17:53	08/12/2020 16:05	07/12/2020 17:53	08/12/2020 16:05	22,19	1	22,19	CHI
20201235059	QUIRINOPOLIS	QI32050365	QUIRINOPOLIS	07/12/2020 17:54	08/12/2020 01:45	07/12/2020 17:54	08/12/2020 01:45	7,84	4	31,37	CHI
20201236136	GOIATUBA	JV12222565RE	VICENTINOPOLIS	07/12/2020 17:54	08/12/2020 09:00	07/12/2020 17:54	08/12/2020 09:00	15,09	15	226,35	CHI
20201236136	VICENTINOPOLIS	JV12222565RE	VICENTINOPOLIS	07/12/2020 17:54	08/12/2020 09:00	07/12/2020 17:54	08/12/2020 09:00	15,09	2	30,18	CHI
20201236136	JOVIANIA	JV12222565RE	VICENTINOPOLIS	07/12/2020 17:54	08/12/2020 09:00	07/12/2020 17:54	08/12/2020 09:00	15,09	6	90,54	CHI
20201236136	BOM JESUS DE GOIAS	JV12222565RE	VICENTINOPOLIS	07/12/2020 17:54	08/12/2020 09:00	07/12/2020 17:54	08/12/2020 09:00	15,09	3	45,27	CHI
20201235105	ITABERAI	IB12099038	ITABERAI S2	07/12/2020 17:55	07/12/2020 21:12	07/12/2020 17:55	07/12/2020 21:12	3,28	15	49,24	CHI
20201235171	GOIANIA	GN12001359	GOIANIA LESTE S2	07/12/2020 17:55	07/12/2020 21:49	07/12/2020 17:55	07/12/2020 21:49	3,88	105	407,84	CHI
20201235070	ANICUNS	AC21259875	ANICUNS	07/12/2020 17:56	07/12/2020 19:19	07/12/2020 17:56	07/12/2020 19:19	1,37	1	1,37	CHI
20201235535	ITUMBIARA	BI12000264	BOM JESUS DE GOIAS	07/12/2020 17:56	08/12/2020 09:39	07/12/2020 17:56	08/12/2020 09:39	15,71	8	125,67	CHI
20201235074	SANTA TEREZINHA DE GOIAS	SG21202039	SANTA TEREZINHA	07/12/2020 17:57	08/12/2020 13:20	07/12/2020 17:57	08/12/2020 12:15	18,29	1	18,29	CHI
20201235074	SANTA TEREZINHA DE GOIAS	SG12202092	SANTA TEREZINHA	07/12/2020 17:57	08/12/2020 13:20	08/12/2020 10:29	08/12/2020 13:20	2,84	5	14,21	CHI
20201235082	GOIANIA	15798185	GOYA S1	07/12/2020 17:58	07/12/2020 20:07	07/12/2020 17:58	07/12/2020 20:07	2,14	1	2,14	CHI
20201235083	MAMBAI	MB11190507	IACIARA S2	07/12/2020 17:59	07/12/2020 21:21	07/12/2020 17:59	07/12/2020 21:21	3,36	4	13,43	CHI
20201235085	PORANGATU	PO21253516	NOVO PLANALTO	07/12/2020 18:00	07/12/2020 22:49	07/12/2020 18:00	07/12/2020 22:49	4,82	1	4,82	CHI
20201235091	CRISTALINA	3490017429	PAMPLONA	07/12/2020 18:00	08/12/2020 04:21	07/12/2020 18:00	08/12/2020 04:21	10,35	1	10,35	CHI
20201235094	ARAGOIANIA	AO11216857	GUAPO S2	07/12/2020 18:01	08/12/2020 13:38	08/12/2020 11:00	08/12/2020 13:38	2,65	33	87,30	CHI
20201235096	CALDAS NOVAS	CN12075111	SERRA DE CALDAS	07/12/2020 18:01	07/12/2020 19:50	07/12/2020 18:01	07/12/2020 19:50	1,80	20	36,07	CHI
20201235098	ITAPACI	IW12094089	ITAPACI	07/12/2020 18:02	08/12/2020 00:31	07/12/2020 18:02	08/12/2020 00:31	6,48	2	12,96	CHI
20201235099	APARECIDA DE GOIANIA	10025772250	INDEPENDENCIA S1	07/12/2020 18:02	07/12/2020 19:39	07/12/2020 18:02	07/12/2020 19:39	1,61	1	1,61	CHI
20201235109	PANAMA	310017373	GOIATUBA S1	07/12/2020 18:02	08/12/2020 00:32	07/12/2020 18:02	07/12/2020 00:32	6,49	1	6,49	CHI
20201235981	DIORAMA	AY12103482	ARENOPOLIS	07/12/2020 18:03	08/12/2020 14:43	08/12/2020 13:07	08/12/2020 14:17	1,16	9	10,48	CHI
20201235981	ARENOPOLIS	AY12103482	ARENOPOLIS	07/12/2020 18:03	08/12/2020 14:43	08/12/2020 13:07	08/12/2020 14:17	1,16	12	13,97	CHI
20201235981	ARENOPOLIS	AY12070195	ARENOPOLIS	07/12/2020 18:03	08/12/2020 14:43	07/12/2020 18:03	08/12/2020 14:43	20,66	10	206,56	CHI
20201235981	DIORAMA	AY12070195	ARENOPOLIS	07/12/2020 18:03	08/12/2020 14:43	07/12/2020 18:03	08/12/2020 14:43	20,66	3	61,97	CHI
20201235981	MONTES CLAROS DE GOIAS	AY12070195	ARENOPOLIS	07/12/2020 18:03	08/12/2020 14:43	07/12/2020 18:03	08/12/2020 14:43	20,66	25	516,40	CHI
20201235110	PIRENOPOLIS	PV21381638	CORUMBA	07/12/2020 18:04	08/12/2020 13:48	07/12/2020 18:04	08/12/2020 13:48	19,73	1	19,73	CHI
20201235116	ABADIA DE GOIAS	GN12057790	CARAJAS S1	07/12/2020 18:05	07/12/2020 23:51	07/12/2020 18:05	07/12/2020 23:51	5,76	2	11,51	CHI
20201235118	ANAPOLIS	AN11335609	ANAPOLIS UNIVERSITARIO S1	07/12/2020 18:05	07/12/2020 19:50	07/12/2020 18:05	07/12/2020 19:50	1,73	88	152,66	CHI
20201235255	IVOLANDIA	IV12037918	IPORA	07/12/2020 18:06	09/12/2020 15:40	07/12/2020 18:06	09/12/2020 15:40	45,56	11	501,11	CHI
20201235414	SANTA FE DE GOIAS	RN12009764	BRITANIA	07/12/2020 18:09	08/12/2020 03:21	07/12/2020 18:09	08/12/2020 03:21	9,19	6	55,12	CHI
20201235146	PARAUNA	PU12304549	PARAUNA	07/12/2020 18:10	07/12/2020 21:30	07/12/2020 18:10	07/12/2020 21:30	3,33	14	46,58	CHI
20201235150	ALTO HORIZONTE	AJ12143571RE	MARA ROSA	07/12/2020 18:11	08/12/2020 01:50	07/12/2020 18:11	08/12/2020 01:50	7,64	37	282,68	CHI

20201235150	MARA ROSA	AJ12143571RE	MARA ROSA	07/12/2020 18:11	08/12/2020 01:50	07/12/2020 18:11	08/12/2020 01:50	7,64	5	38,20	CHI
20201235150	NOVA IGUACU DE GOIAS	AJ12143571RE	MARA ROSA	07/12/2020 18:11	08/12/2020 01:50	07/12/2020 18:11	08/12/2020 01:50	7,64	12	91,68	CHI
20201235155	RIO QUENTE	CN12000043	RIO QUENTE	07/12/2020 18:11	07/12/2020 21:05	07/12/2020 18:11	07/12/2020 21:05	2,89	1	2,89	CHI
20201235168	CACHOEIRA ALTA	CA21402291	CACHOEIRA ALTA	07/12/2020 18:14	08/12/2020 04:17	07/12/2020 18:14	08/12/2020 04:17	10,04	1	10,04	CHI
20201235169	ORIZONA	2060012930	PIRES DO RIO S2	07/12/2020 18:14	08/12/2020 09:13	07/12/2020 18:14	08/12/2020 09:13	14,97	1	14,97	CHI
20201235177	JUSSARA	JR12341214	BRITANIA	07/12/2020 18:14	08/12/2020 11:30	07/12/2020 18:14	08/12/2020 11:30	17,28	3	51,83	CHI
20201235182	MINEIROS	MY12278372	PARQUE DAS EMAS	07/12/2020 18:18	08/12/2020 20:11	07/12/2020 18:18	08/12/2020 20:11	25,88	3	77,64	CHI
20201235673	SANTO ANTONIO DO DESCOBERTO	AX12402045	ALEXANIA	07/12/2020 18:18	08/12/2020 00:44	07/12/2020 18:18	08/12/2020 00:44	6,43	1	6,43	CHI
20201235673	ALEXANIA	AX12402045	ALEXANIA	07/12/2020 18:18	08/12/2020 00:44	07/12/2020 18:18	08/12/2020 00:44	6,43	207	1330,49	CHI
20201235188	ITABERAI	O0880414	ITABERAI S1	07/12/2020 18:19	07/12/2020 21:52	07/12/2020 21:27	07/12/2020 21:50	0,38	10	3,78	CHI
20201235188	ITABERAI	GS10400737	ITABERAI S1	07/12/2020 18:19	07/12/2020 21:52	07/12/2020 21:27	07/12/2020 21:52	0,42	92	38,18	CHI
20201235188	GOIAS	GS10400737	ITABERAI S1	07/12/2020 18:19	07/12/2020 21:52	07/12/2020 21:27	07/12/2020 21:52	0,42	5	2,08	CHI
20201235488	NOVA IGUACU DE GOIAS	NH12317131	CAMPINORTE	07/12/2020 18:19	07/12/2020 21:54	07/12/2020 18:19	07/12/2020 21:54	3,58	44	157,63	CHI
20201235190	CRIXAS	10020310372	SANTA TEREZINHA	07/12/2020 18:20	08/12/2020 14:23	07/12/2020 18:20	08/12/2020 14:23	20,05	1	20,05	CHI
20201235192	COLINAS DO SUL	TI21365400	NIQUELANDIA SUBTRANSMISSAO	07/12/2020 18:20	08/12/2020 04:29	07/12/2020 18:20	08/12/2020 04:29	10,15	1	10,15	CHI
20201235196	LUZANIA	10005895250	RIO VERMELHO	07/12/2020 18:20	08/12/2020 00:23	07/12/2020 18:20	08/12/2020 00:23	6,04	1	6,04	CHI
20201235202	GOIANIA	17074289	AEROPORTO S3	07/12/2020 18:21	07/12/2020 19:47	07/12/2020 18:21	07/12/2020 19:47	1,42	1	1,42	CHI
20201235206	UIRAPURU	UP12397484	NOVA CRIXAS	07/12/2020 18:21	08/12/2020 18:53	07/12/2020 18:21	08/12/2020 18:53	24,52	5	122,59	CHI
20201235207	CACHOEIRA DOURADA	CD21208149	CACHOEIRA DOURADA	07/12/2020 18:21	08/12/2020 09:41	07/12/2020 18:21	08/12/2020 09:41	15,32	1	15,32	CHI
20201232793	IVOLANDIA	IV12207829	IPORA	07/12/2020 18:22	08/12/2020 09:54	07/12/2020 18:22	08/12/2020 09:54	15,52	3	46,55	CHI
20201235215	SANTO ANTONIO DO DESCOBERTO	SN21214792	AGUAS LINDAS DE GOIAS S2	07/12/2020 18:24	07/12/2020 19:41	07/12/2020 18:24	07/12/2020 19:41	1,28	1	1,28	CHI
20201235216	PALMINOPOLIS	PP21039178	PALMEIRAS	07/12/2020 18:24	07/12/2020 20:02	07/12/2020 18:24	07/12/2020 20:02	1,63	1	1,63	CHI
20201235222	JATAI	JT12202689	JATAI S1	07/12/2020 18:25	07/12/2020 21:57	07/12/2020 18:25	07/12/2020 21:57	3,52	2	7,04	CHI
20201235227	MINEIROS	1390122557	PARQUE DAS EMAS	07/12/2020 18:27	08/12/2020 10:45	07/12/2020 18:27	08/12/2020 10:45	16,30	1	16,30	CHI
20201235360	AMORINOPOLIS	AM12035305	IPORA	07/12/2020 18:27	08/12/2020 11:40	07/12/2020 18:27	08/12/2020 11:40	17,20	12	206,44	CHI
20201235234	CACHOEIRA ALTA	CA12075243	CACHOEIRA ALTA	07/12/2020 18:28	08/12/2020 11:24	07/12/2020 18:28	08/12/2020 11:24	16,93	5	84,63	CHI
20201235236	CRISTALINA	KR21163121	CRISTALINA S2	07/12/2020 18:28	07/12/2020 23:47	07/12/2020 18:28	07/12/2020 23:47	5,31	1	5,31	CHI
20201235237	JAUPACI	JP12207789	IPORA	07/12/2020 18:28	08/12/2020 11:22	07/12/2020 18:28	08/12/2020 11:22	16,89	15	253,28	CHI
20201235237	FAZENDA NOVA	JP12207789	IPORA	07/12/2020 18:28	08/12/2020 11:22	07/12/2020 18:28	08/12/2020 11:22	16,89	19	320,82	CHI
20201235241	FLORES DE GOIAS	3480018360	FLORES DE GOIAS	07/12/2020 18:29	08/12/2020 11:35	07/12/2020 18:29	08/12/2020 11:35	17,09	1	17,09	CHI
20201235242	ANAPOLIS	21383868	JUNDIAI S2	07/12/2020 18:29	08/12/2020 01:03	07/12/2020 18:29	08/12/2020 01:03	6,56	1	6,56	CHI
20201235243	FLORES DE GOIAS	FB12325041	IACIARA S2	07/12/2020 18:30	08/12/2020 13:58	07/12/2020 18:30	08/12/2020 13:41	19,18	7	134,25	CHI
20201235243	FLORES DE GOIAS	FB12426833	IACIARA S2	07/12/2020 18:30	08/12/2020 13:58	07/12/2020 18:30	08/12/2020 13:58	19,46	16	311,40	CHI
20201235244	GOIANIA	13566570	GOYA S1	07/12/2020 18:30	07/12/2020 21:01	07/12/2020 18:30	07/12/2020 21:01	2,51	1	2,51	CHI
20201235327	SERRANOPOLIS	02430414	CHAPADAO DO CEU	07/12/2020 18:31	10/12/2020 08:33	07/12/2020 18:31	07/12/2020 18:37	0,10	33	3,42	CHI
20201235327	MINEIROS	02430414	CHAPADAO DO CEU	07/12/2020 18:31	10/12/2020 08:33	07/12/2020 18:31	07/12/2020 18:37	0,10	6	0,62	CHI
20201235327	CHAPADAO DO CEU	02430414	CHAPADAO DO CEU	07/12/2020 18:31	10/12/2020 08:33	07/12/2020 18:31	07/12/2020 18:37	0,10	10	1,04	CHI
20201235327	SERRANOPOLIS	02430414	CHAPADAO DO CEU	07/12/2020 18:31	10/12/2020 08:33	07/12/2020 18:32	07/12/2020 18:37	0,09	1	0,09	CHI
20201235327	CHAPADAO DO CEU	02430414	CHAPADAO DO CEU	07/12/2020 18:31	10/12/2020 08:33	07/12/2020 18:32	07/12/2020 18:37	0,09	1	0,09	CHI
20201235327	MINEIROS	02430414	CHAPADAO DO CEU	07/12/2020 18:31	10/12/2020 08:33	07/12/2020 18:31	07/12/2020 18:45	0,23	20	4,68	CHI
20201235327	SERRANOPOLIS	02430414	CHAPADAO DO CEU	07/12/2020 18:31	10/12/2020 08:33	07/12/2020 18:31	07/12/2020 18:45	0,23	50	11,69	CHI
20201235327	SERRANOPOLIS	02430414	CHAPADAO DO CEU	07/12/2020 18:31	10/12/2020 08:33	07/12/2020 18:44	07/12/2020 19:47	1,05	11	11,58	CHI
20201235327	CHAPADAO DO CEU	02430414	CHAPADAO DO CEU	07/12/2020 18:31	10/12/2020 08:33	07/12/2020 18:44	07/12/2020 19:47	1,05	11	11,58	CHI
20201235327	SERRANOPOLIS	DJ10418274	CHAPADAO DO CEU	07/12/2020 18:31	10/12/2020 08:33	07/12/2020 18:44	07/12/2020 20:16	1,54	23	35,39	CHI
20201235327	MINEIROS	DJ10418274	CHAPADAO DO CEU	07/12/2020 18:31	10/12/2020 08:33	07/12/2020 18:44	07/12/2020 20:16	1,54	6	9,23	CHI
20201235327	SERRANOPOLIS	DJ13164076	CHAPADAO DO CEU	07/12/2020 18:31	10/12/2020 08:33	07/12/2020 20:09	07/12/2020 21:36	1,45	11	15,96	CHI
20201235327	CHAPADAO DO CEU	02430414	CHAPADAO DO CEU	07/12/2020 18:31	10/12/2020 08:33	07/12/2020 20:09	07/12/2020 22:24	2,25	2	4,51	CHI
20201235327	JATAI	JT10400238	JATAI S1	07/12/2020 18:31	10/12/2020 08:33	08/12/2020 16:44	08/12/2020 17:01	0,29	39	11,17	CHI
20201235327	SERRANOPOLIS	JT10400238	JATAI S1	07/12/2020 18:31	10/12/2020 08:33	08/12/2020 16:44	08/12/2020 17:01	0,29	6	1,72	CHI
20201235327	SERRANOPOLIS	SX10400642	CHAPADAO DO CEU	07/12/2020 18:31	10/12/2020 08:33	08/12/2020 16:44	08/12/2020 17:03	0,32	84	26,83	CHI
20201235327	MINEIROS	SX10400642	CHAPADAO DO CEU	07/12/2020 18:31	10/12/2020 08:33	08/12/2020 16:44	08/12/2020 17:03	0,32	26	8,31	CHI

20201235327	JATAI	JT10400238	JATAI S1	07/12/2020 18:31	10/12/2020 08:33	08/12/2020 17:30	08/12/2020 17:34	0,06	39	2,49	CHI
20201235327	SERRANOPOLIS	JT10400238	JATAI S1	07/12/2020 18:31	10/12/2020 08:33	08/12/2020 17:30	08/12/2020 17:34	0,06	6	0,38	CHI
20201235327	CHAPADAO DO CEU	DJ13164069	CHAPADAO DO CEU	07/12/2020 18:31	10/12/2020 08:33	07/12/2020 20:09	08/12/2020 18:30	22,35	9	201,14	CHI
20201235327	SERRANOPOLIS	DJ13164074	CHAPADAO DO CEU	07/12/2020 18:31	10/12/2020 08:33	08/12/2020 17:30	08/12/2020 22:01	4,53	23	104,09	CHI
20201235327	MINEIROS	DJ13164074	CHAPADAO DO CEU	07/12/2020 18:31	10/12/2020 08:33	08/12/2020 17:30	08/12/2020 22:01	4,53	6	27,15	CHI
20201235327	SERRANOPOLIS	SX10400642	CHAPADAO DO CEU	07/12/2020 18:31	10/12/2020 08:33	08/12/2020 17:30	09/12/2020 08:37	15,13	11	166,42	CHI
20201235327	SERRANOPOLIS	SX10400642	CHAPADAO DO CEU	07/12/2020 18:31	10/12/2020 08:33	08/12/2020 17:30	09/12/2020 17:14	23,74	5	118,71	CHI
20201235327	MINEIROS	SX10400642	CHAPADAO DO CEU	07/12/2020 18:31	10/12/2020 08:33	08/12/2020 17:30	09/12/2020 17:14	23,74	20	474,84	CHI
20201235327	JATAI	JT10400238	JATAI S1	07/12/2020 18:31	10/12/2020 08:33	09/12/2020 18:32	09/12/2020 18:46	0,24	39	9,22	CHI
20201235327	SERRANOPOLIS	JT10400238	JATAI S1	07/12/2020 18:31	10/12/2020 08:33	09/12/2020 18:32	09/12/2020 18:46	0,24	6	1,42	CHI
20201235327	SERRANOPOLIS	SX10400642	CHAPADAO DO CEU	07/12/2020 18:31	10/12/2020 08:33	09/12/2020 18:32	09/12/2020 18:53	0,35	5	1,73	CHI
20201235327	MINEIROS	SX10400642	CHAPADAO DO CEU	07/12/2020 18:31	10/12/2020 08:33	09/12/2020 18:32	09/12/2020 18:53	0,35	20	6,92	CHI
20201235327	SERRANOPOLIS	SX10400642	CHAPADAO DO CEU	07/12/2020 18:31	10/12/2020 08:33	08/12/2020 17:30	09/12/2020 19:53	26,39	11	290,26	CHI
20201235327	SERRANOPOLIS	SX10400642	CHAPADAO DO CEU	07/12/2020 18:31	10/12/2020 08:33	08/12/2020 17:30	09/12/2020 20:28	26,97	2	53,95	CHI
20201235327	SERRANOPOLIS	SX10400642	CHAPADAO DO CEU	07/12/2020 18:31	10/12/2020 08:33	10/12/2020 00:41	10/12/2020 00:51	0,17	5	0,83	CHI
20201235327	MINEIROS	SX10400642	CHAPADAO DO CEU	07/12/2020 18:31	10/12/2020 08:33	10/12/2020 00:41	10/12/2020 00:51	0,17	20	3,33	CHI
20201235327	SERRANOPOLIS	SX10400642	CHAPADAO DO CEU	07/12/2020 18:31	10/12/2020 08:33	08/12/2020 17:30	10/12/2020 06:56	37,43	27	1010,72	CHI
20201235327	SERRANOPOLIS	SX10400642	CHAPADAO DO CEU	07/12/2020 18:31	10/12/2020 08:33	08/12/2020 17:30	10/12/2020 07:21	37,86	1	37,86	CHI
20201235327	SERRANOPOLIS	SX10400642	CHAPADAO DO CEU	07/12/2020 18:31	10/12/2020 08:33	08/12/2020 17:30	10/12/2020 07:44	38,25	1	38,25	CHI
20201235327	SERRANOPOLIS	SX10400642	CHAPADAO DO CEU	07/12/2020 18:31	10/12/2020 08:33	08/12/2020 17:30	10/12/2020 08:05	38,59	1	38,59	CHI
20201235327	SERRANOPOLIS	SX10400642	CHAPADAO DO CEU	07/12/2020 18:31	10/12/2020 08:33	08/12/2020 17:30	10/12/2020 08:25	38,91	1	38,91	CHI
20201235327	SERRANOPOLIS	SX10400642	CHAPADAO DO CEU	07/12/2020 18:31	10/12/2020 08:33	08/12/2020 17:30	10/12/2020 08:33	39,06	1	39,06	CHI
20201235627	IVOLANDIA	AM12000037	IPORA	07/12/2020 18:32	08/12/2020 07:47	07/12/2020 18:32	08/12/2020 07:47	13,24	9	119,18	CHI
20201235627	AMORINOPOLIS	AM12000037	IPORA	07/12/2020 18:32	08/12/2020 07:47	07/12/2020 18:32	08/12/2020 07:47	13,24	10	132,42	CHI
20201235263	TURVELANDIA	TD12382674	RIO DOS BOIS	07/12/2020 18:33	07/12/2020 22:56	07/12/2020 18:33	07/12/2020 22:56	4,38	1	4,38	CHI
20201235270	ITAJA	IJ12370148	ITAJA S2	07/12/2020 18:34	07/12/2020 20:40	07/12/2020 18:34	07/12/2020 20:40	2,09	2	4,18	CHI
20201235275	PORANGATU	PO21230421	PORANGATU	07/12/2020 18:35	07/12/2020 23:53	07/12/2020 18:35	07/12/2020 23:53	5,29	1	5,29	CHI
20201235480	ORIZONA	OZ12143757	PIRES DO RIO S2	07/12/2020 18:35	08/12/2020 09:22	07/12/2020 18:35	08/12/2020 09:22	14,78	38	561,66	CHI
20201235276	GOIANIA	GN11166138	GOYA S2	07/12/2020 18:36	07/12/2020 20:20	07/12/2020 18:36	07/12/2020 20:20	1,73	42	72,79	CHI
20201235277	ITUMBIARA	IT12352670	CACHOEIRA DOURADA	07/12/2020 18:36	08/12/2020 09:05	07/12/2020 18:36	08/12/2020 09:05	14,48	6	86,89	CHI
20201235277	BOM JESUS DE GOIAS	IT12352670	CACHOEIRA DOURADA	07/12/2020 18:36	08/12/2020 09:05	07/12/2020 18:36	08/12/2020 09:05	14,48	2	28,96	CHI
20201235281	MAMBAI	MB11161460	IACIARA S2	07/12/2020 18:37	07/12/2020 22:06	07/12/2020 18:37	07/12/2020 22:06	3,48	3	10,44	CHI
20201235284	ARENOPOLIS	AY12000037	ARENOPOLIS	07/12/2020 18:37	08/12/2020 08:39	07/12/2020 18:37	08/12/2020 08:39	14,03	2	28,05	CHI
20201235508	SAO MIGUEL DO ARAGUAIA	SM12236306	SAO MIGUEL DO ARAGUAIA	07/12/2020 18:37	08/12/2020 04:13	07/12/2020 18:37	08/12/2020 04:13	9,59	2	19,18	CHI
20201235331	FORMOSA	FA11129924	ITUIQUIRA	07/12/2020 18:38	07/12/2020 19:41	07/12/2020 18:38	07/12/2020 19:41	1,04	253	263,05	CHI
20201235296	INDIARA	IY12233476	EDEIA	07/12/2020 18:39	07/12/2020 22:42	07/12/2020 18:39	07/12/2020 22:42	4,04	39	157,40	CHI
20201235297	ITAPACI	10017685735	ITAPACI	07/12/2020 18:40	07/12/2020 21:38	07/12/2020 18:40	07/12/2020 21:38	2,97	1	2,97	CHI
20201235298	PIRENOPOLIS	PV21334647	CORUMBA	07/12/2020 18:40	08/12/2020 00:29	07/12/2020 18:40	08/12/2020 00:29	5,82	1	5,82	CHI
20201235307	ITABERAÍ	IB31183014	ITABERAÍ S2	07/12/2020 18:41	07/12/2020 20:24	07/12/2020 18:41	07/12/2020 20:24	1,70	1	1,70	CHI
20201235932	SANTA HELENA DE GOIAS	SH12301283	IPEGUARI	07/12/2020 18:42	07/12/2020 22:31	07/12/2020 18:42	07/12/2020 22:31	3,80	7	26,61	CHI
20201235318	CALDAZINHA	BV21056957	CEPAIGO S2	07/12/2020 18:43	08/12/2020 04:42	07/12/2020 18:43	08/12/2020 04:42	9,97	2	19,94	CHI
20201235728	MINEIROS	MY12390605RE	PARQUE DAS EMAS	07/12/2020 18:44	08/12/2020 10:15	07/12/2020 18:44	08/12/2020 10:15	15,52	15	232,73	CHI
20201235335	SANTA ROSA DE GOIAS	SR21000031	INHUMAS S1	07/12/2020 18:45	08/12/2020 04:02	07/12/2020 18:45	08/12/2020 04:02	9,27	1	9,27	CHI
20201235404	ANAPOLIS	AN12258789	ANAPOLIS UNIVERSITARIO S1	07/12/2020 18:45	07/12/2020 23:52	07/12/2020 18:45	07/12/2020 23:52	5,11	13	66,37	CHI
20201235351	PADRE BERNARDO	PB11039329	PADRE BERNARDO	07/12/2020 18:46	07/12/2020 21:34	07/12/2020 18:46	07/12/2020 21:34	2,79	108	300,84	CHI
20201235343	ANAPOLIS	21192406	JUNDIAI S1	07/12/2020 18:47	07/12/2020 22:45	07/12/2020 18:47	07/12/2020 22:45	3,98	1	3,98	CHI
20201235347	SAO MIGUEL DO ARAGUAIA	SM12350501	SAO MIGUEL DO ARAGUAIA	07/12/2020 18:47	08/12/2020 10:23	07/12/2020 18:47	08/12/2020 10:23	15,59	6	93,55	CHI
20201235413	DIORAMA	DI12188377	ARENOPOLIS	07/12/2020 18:47	08/12/2020 12:04	07/12/2020 18:47	08/12/2020 12:04	17,28	12	207,32	CHI
20201235413	ARENOPOLIS	DI12188377	ARENOPOLIS	07/12/2020 18:47	08/12/2020 12:04	07/12/2020 18:47	08/12/2020 12:04	17,28	1	17,28	CHI
20201235712	PIRENOPOLIS	PV12334635	CORUMBA	07/12/2020 18:47	08/12/2020 04:44	07/12/2020 18:47	08/12/2020 04:44	9,95	8	79,56	CHI
20201235373	ARENOPOLIS	AY12390169	ARENOPOLIS	07/12/2020 18:50	08/12/2020 09:34	07/12/2020 18:50	08/12/2020 09:34	14,72	22	323,83	CHI

20201235373	DIORAMA	AY12390169	ARENOPOLIS	07/12/2020 18:50	08/12/2020 09:34	07/12/2020 18:50	08/12/2020 09:34	14,72	3	44,16	CHI
20201235364	EDEIA	EA21086965	EDEIA	07/12/2020 18:51	07/12/2020 20:46	07/12/2020 18:51	07/12/2020 20:46	1,91	2	3,82	CHI
20201235370	AGUAS LINDAS DE GOIAS	LA11149773	AGUAS LINDAS DE GOIAS S1	07/12/2020 18:53	07/12/2020 20:55	07/12/2020 18:53	07/12/2020 20:55	2,02	93	187,94	CHI
20201235374	MORRINHOS	10002338260	MORRINHOS	07/12/2020 18:54	07/12/2020 23:45	07/12/2020 18:54	07/12/2020 23:45	4,84	1	4,84	CHI
20201235378	SAO JOAO D ALIANCA	6918471	SAO JOAO D ALIANCA	07/12/2020 18:55	07/12/2020 22:52	07/12/2020 18:55	07/12/2020 22:52	3,94	5	19,72	CHI
20201235380	GUAPO	10010126722	GUAPO S1	07/12/2020 18:56	08/12/2020 00:17	07/12/2020 18:56	08/12/2020 00:17	5,35	1	5,35	CHI
20201235381	FLORES DE GOIAS	FB12433403	IACIARA S2	07/12/2020 18:56	08/12/2020 14:46	07/12/2020 18:56	08/12/2020 14:46	19,82	4	79,30	CHI
20201235392	APARECIDA DE GOIANIA	14846512	INDEPENDENCIA S1	07/12/2020 18:57	07/12/2020 21:45	07/12/2020 18:57	07/12/2020 21:45	2,79	1	2,79	CHI
20201235996	MONTIVIDIU	MV12267625	MONTIVIDIU T	07/12/2020 18:57	08/12/2020 16:39	07/12/2020 18:57	08/12/2020 16:39	21,69	4	86,78	CHI
20201235396	MAIRIPOTABA	6460843	PONTALINA	07/12/2020 18:58	07/12/2020 23:37	07/12/2020 18:58	07/12/2020 23:37	4,64	1	4,64	CHI
20201235400	GOIANIA	GN11323305	CARAJAS S1	07/12/2020 18:58	07/12/2020 22:22	07/12/2020 18:58	07/12/2020 22:22	3,39	130	440,63	CHI
20201235402	SANCLERLANDIA	SC12323865	FIRMINOPOLIS S2	07/12/2020 18:59	07/12/2020 21:17	07/12/2020 18:59	07/12/2020 21:17	2,29	1	2,29	CHI
20201235430	IACIARA	IA12195949	IACIARA S1	07/12/2020 19:02	08/12/2020 00:46	07/12/2020 19:02	08/12/2020 00:46	5,72	19	108,74	CHI
20201235423	ITAPIRAPUA	IU21220298	MATRINCHA	07/12/2020 19:04	08/12/2020 09:09	07/12/2020 19:04	08/12/2020 09:09	14,08	1	14,08	CHI
20201235424	PARANAIGUARA	2230042276	CACHOEIRA ALTA	07/12/2020 19:04	07/12/2020 20:55	07/12/2020 19:04	07/12/2020 20:55	1,85	1	1,85	CHI
20201235439	RIO VERDE	RV12131656	RIO VERDE S1	07/12/2020 19:06	08/12/2020 02:21	07/12/2020 19:06	08/12/2020 02:21	7,25	5	36,23	CHI
20201235442	INHUMAS	30082584	INHUMAS S2	07/12/2020 19:08	07/12/2020 20:18	07/12/2020 19:08	07/12/2020 20:18	1,17	1	1,17	CHI
20201235444	GOIANIA	16486808	GOIANIA LESTE S1	07/12/2020 19:08	07/12/2020 20:48	07/12/2020 19:08	07/12/2020 20:48	1,66	1	1,66	CHI
20201235446	GOIANIA	10011999606	GOYA S1	07/12/2020 19:08	07/12/2020 21:06	07/12/2020 19:08	07/12/2020 21:06	1,96	1	1,96	CHI
20201235449	IPORA	IR21188351	ARENOPOLIS	07/12/2020 19:08	08/12/2020 13:05	07/12/2020 19:08	08/12/2020 13:05	17,93	1	17,93	CHI
20201235455	SAO MIGUEL DO ARAGUAIA	SM21128371	SAO MIGUEL DO ARAGUAIA	07/12/2020 19:10	08/12/2020 09:32	07/12/2020 19:10	08/12/2020 09:32	14,35	1	14,35	CHI
20201235458	JATAI	JT12324858	JATAI S1	07/12/2020 19:10	07/12/2020 22:36	07/12/2020 19:10	07/12/2020 22:36	3,42	3	10,25	CHI
20201235459	PALMELO	PZ11000146	PIRES DO RIO S2	07/12/2020 19:11	07/12/2020 22:21	07/12/2020 19:11	07/12/2020 22:21	3,15	100	315,06	CHI
20201235461	GOIATUBA	JV12208104	GOIATUBA S1	07/12/2020 19:12	08/12/2020 11:32	07/12/2020 19:12	08/12/2020 11:32	16,33	13	212,24	CHI
20201235461	JOVIANIA	JV12208104	GOIATUBA S1	07/12/2020 19:12	08/12/2020 11:32	07/12/2020 19:12	08/12/2020 11:32	16,33	5	81,63	CHI
20201235469	GOIANIA	14082809	FERROVIARIO S2	07/12/2020 19:14	07/12/2020 21:49	07/12/2020 19:14	07/12/2020 21:49	2,57	1	2,57	CHI
20201235587	TRINDADE	TR11053490	TRINDADE	07/12/2020 19:14	08/12/2020 02:11	07/12/2020 19:14	08/12/2020 02:11	6,95	84	583,50	CHI
20201235930	SAO JOAO D ALIANCA	FA18407028TS	SAO JOAO D ALIANCA	07/12/2020 19:14	08/12/2020 02:42	07/12/2020 19:14	08/12/2020 02:42	7,46	51	380,26	CHI
20201235930	FLORES DE GOIAS	FA18407028TS	SAO JOAO D ALIANCA	07/12/2020 19:14	08/12/2020 02:42	07/12/2020 19:14	08/12/2020 02:42	7,46	7	52,19	CHI
20201235930	FORMOSA	FA18407028TS	SAO JOAO D ALIANCA	07/12/2020 19:14	08/12/2020 02:42	07/12/2020 19:14	08/12/2020 02:42	7,46	208	1550,87	CHI
20201235472	JUSSARA	JR12259703	JUSSARA S1	07/12/2020 19:15	08/12/2020 03:20	07/12/2020 19:15	08/12/2020 03:20	8,08	1	8,08	CHI
20201235473	NOVA ROMA	5610002179	IACIARA S2	07/12/2020 19:15	08/12/2020 12:32	07/12/2020 19:15	08/12/2020 12:32	17,28	1	17,28	CHI
20201235474	GOIAS	90064150	GOIAS	07/12/2020 19:15	08/12/2020 07:50	07/12/2020 19:15	08/12/2020 07:50	12,58	1	12,58	CHI
20201235527	PARAUNA	PU12336680	PARAUNA	07/12/2020 19:17	07/12/2020 23:30	07/12/2020 19:17	07/12/2020 23:30	4,21	41	172,44	CHI
20201235490	QUIRINOPOLIS	80080510	QUIRINOPOLIS	07/12/2020 19:19	07/12/2020 22:47	07/12/2020 19:19	07/12/2020 22:47	3,46	1	3,46	CHI
20201235497	APORE	AE12214470	ITAJA S1	07/12/2020 19:21	08/12/2020 14:07	07/12/2020 19:21	08/12/2020 14:07	18,76	1	18,76	CHI
20201235506	TRINDADE	TR11241344	TRINDADE	07/12/2020 19:21	07/12/2020 23:21	07/12/2020 19:21	07/12/2020 23:21	3,99	147	586,12	CHI
20201235505	JARAGUA	70131934	JARAGUA	07/12/2020 19:22	08/12/2020 09:20	07/12/2020 19:22	08/12/2020 09:20	13,96	1	13,96	CHI
20201235599	MORRINHOS	MR12105036	MORRINHOS	07/12/2020 19:23	07/12/2020 23:00	07/12/2020 19:23	07/12/2020 23:00	3,61	16	57,75	CHI
20201235518	ANAPOLIS	AN12000882	JUNDIAI S1	07/12/2020 19:24	07/12/2020 23:15	07/12/2020 19:24	07/12/2020 23:15	3,84	50	192,01	CHI
20201235523	JATAI	290051472	JATAI S3	07/12/2020 19:25	08/12/2020 11:54	07/12/2020 19:25	08/12/2020 11:54	16,48	1	16,48	CHI
20201235531	IVOLANDIA	IV12011808	IPORA	07/12/2020 19:26	08/12/2020 10:34	07/12/2020 19:26	08/12/2020 10:34	15,13	23	348,04	CHI
20201235539	ABADIANIA	AA12388792	DAIA S2	07/12/2020 19:27	08/12/2020 01:26	07/12/2020 19:27	08/12/2020 01:26	5,97	2	11,94	CHI
20201235541	LUZIANIA	LZ11214875	RIO VERMELHO	07/12/2020 19:28	07/12/2020 23:56	07/12/2020 19:28	07/12/2020 23:56	4,46	20	89,13	CHI
20201235545	APARECIDA DE GOIANIA	14821102	INDEPENDENCIA S2	07/12/2020 19:28	08/12/2020 00:04	07/12/2020 19:28	08/12/2020 00:04	4,59	1	4,59	CHI
20201234225	CAIAPONIA	RV12030683	MONTIVIDIU T	07/12/2020 19:30	08/12/2020 07:45	07/12/2020 19:30	08/12/2020 07:45	12,25	212	2597,00	CHI
20201234225	RIO VERDE	RV12030683	MONTIVIDIU T	07/12/2020 19:30	08/12/2020 07:45	07/12/2020 19:30	08/12/2020 07:45	12,25	3	36,75	CHI
20201235549	JATAI	JT21000144	JATAI S1	07/12/2020 19:30	07/12/2020 21:35	07/12/2020 19:30	07/12/2020 21:35	2,07	1	2,07	CHI
20201235564	SANTO ANTONIO DO DESCOBERTO	SN12330527	MARAJOARA	07/12/2020 19:33	08/12/2020 04:47	07/12/2020 19:33	08/12/2020 04:47	9,23	14	129,17	CHI
20201235568	VIANOPOLIS	SV12102994	VIANOPOLIS	07/12/2020 19:35	07/12/2020 22:47	07/12/2020 19:35	07/12/2020 22:47	3,19	119	379,35	CHI
20201235568	SAO MIGUEL DO PASSA QUATRO	SV12102994	VIANOPOLIS	07/12/2020 19:35	07/12/2020 22:47	07/12/2020 19:35	07/12/2020 22:47	3,19	65	207,21	CHI

20201235568	SILVANIA	SV12102994	VIANOPOLIS	07/12/2020 19:35	07/12/2020 22:47	07/12/2020 19:35	07/12/2020 22:47	3,19	79	251,83	CHI
20201235573	MINACU	IH12202490	MINACU	07/12/2020 19:36	08/12/2020 14:21	07/12/2020 19:36	08/12/2020 14:21	18,74	3	56,22	CHI
20201235634	PALESTINA DE GOIAS	IV12129886	IPORA	07/12/2020 19:36	08/12/2020 10:31	07/12/2020 19:36	08/12/2020 10:31	14,90	12	178,81	CHI
20201235634	IVOLANDIA	IV12129886	IPORA	07/12/2020 19:36	08/12/2020 10:31	07/12/2020 19:36	08/12/2020 10:31	14,90	44	655,65	CHI
20201235583	RIO VERDE	630584242	CABRIUVA S1	07/12/2020 19:38	07/12/2020 22:01	07/12/2020 19:38	07/12/2020 22:01	2,38	1	2,38	CHI
20201235639	TRINDADE	TR11383861	GOYA S2	07/12/2020 19:38	08/12/2020 00:44	07/12/2020 19:38	08/12/2020 00:44	5,10	92	469,15	CHI
20201235594	CATALAO	CT11000019	CATALAO S2	07/12/2020 19:42	07/12/2020 20:45	07/12/2020 19:42	07/12/2020 20:45	1,04	195	203,67	CHI
20201235613	APARECIDA DE GOIANIA	17452454	ATLANTICO S1	07/12/2020 19:44	07/12/2020 21:00	07/12/2020 19:44	07/12/2020 21:00	1,26	1	1,26	CHI
20201235614	UIRAPURU	UP12232068	SANTA TEREZINHA	07/12/2020 19:45	11/12/2020 16:29	07/12/2020 19:45	11/12/2020 16:29	92,73	1	92,73	CHI
20201235615	CALDAS NOVAS	CN21103277	CALDAS NOVAS S1	07/12/2020 19:45	07/12/2020 22:20	07/12/2020 19:45	07/12/2020 22:20	2,59	1	2,59	CHI
20201235616	CALDAS NOVAS	760371106	SERRA DE CALDAS	07/12/2020 19:45	07/12/2020 22:56	07/12/2020 19:45	07/12/2020 22:56	3,17	1	3,17	CHI
20201235618	ITABERAI	50079578	ITABERAI S2	07/12/2020 19:46	08/12/2020 08:07	07/12/2020 19:46	08/12/2020 08:07	12,35	1	12,35	CHI
20201235860	APARECIDA DE GOIANIA	AP11095980	INDEPENDENCIA S1	07/12/2020 19:46	07/12/2020 21:40	07/12/2020 19:46	07/12/2020 21:40	1,89	190	359,26	CHI
20201235623	CAIAPONIA	CP12201002	MONTIVIDIU T	07/12/2020 19:47	08/12/2020 10:59	07/12/2020 19:47	08/12/2020 10:59	15,19	2	30,39	CHI
20201235625	GOIANIA	12579014	ATLANTICO S3	07/12/2020 19:47	07/12/2020 23:15	07/12/2020 19:47	07/12/2020 23:15	3,46	1	3,46	CHI
20201235631	RUBIATABA	780035800	RUBIATABA	07/12/2020 19:48	08/12/2020 10:55	07/12/2020 19:48	08/12/2020 10:55	15,10	1	15,10	CHI
20201235636	CAMPOS VERDES	VD21054417	SANTA TEREZINHA	07/12/2020 19:49	07/12/2020 23:19	07/12/2020 19:49	07/12/2020 23:19	3,50	1	3,50	CHI
20201235643	HIDROLANDIA	HD11281029	ANHANGUERA	07/12/2020 19:51	08/12/2020 01:41	07/12/2020 19:51	08/12/2020 01:41	5,83	12	69,90	CHI
20201235645	PIRENOPOLIS	ZN21244046	COCALZINHO	07/12/2020 19:51	08/12/2020 01:20	07/12/2020 19:51	08/12/2020 01:20	5,47	1	5,47	CHI
20201235796	CATALAO	CT11166805	CATALAO S2	07/12/2020 19:56	07/12/2020 21:19	07/12/2020 19:56	07/12/2020 21:19	1,37	95	130,44	CHI
20201235660	ANICUNS	AC21000085	ANICUNS	07/12/2020 19:57	07/12/2020 22:40	07/12/2020 19:57	07/12/2020 22:40	2,71	2	5,43	CHI
20201235667	ANAPOLIS	20631005	ANAPOLIS UNIVERSITARIO S2	07/12/2020 19:58	07/12/2020 23:29	07/12/2020 19:58	07/12/2020 23:29	3,50	1	3,50	CHI
20201235992	MUNDO NOVO DE GOIAS	MH12274995	NOVA CRIXAS	07/12/2020 19:58	07/12/2020 23:17	07/12/2020 19:58	07/12/2020 23:17	3,31	9	29,81	CHI
20201235669	ALVORADA DO NORTE	151002536	IACIARA S2	07/12/2020 19:59	07/12/2020 22:33	07/12/2020 19:59	07/12/2020 22:33	2,56	1	2,56	CHI
20201235671	TURVANIA	1220016059	FIRMINOPOLIS S2	07/12/2020 20:02	07/12/2020 22:31	07/12/2020 20:02	07/12/2020 22:31	2,47	1	2,47	CHI
20201235677	BOM JARDIM DE GOIAS	BM21229603	BOM JARDIM	07/12/2020 20:03	08/12/2020 02:35	07/12/2020 20:03	08/12/2020 02:35	6,52	1	6,52	CHI
20201235703	ANAPOLIS	AN11130801	JUNDIAI S2	07/12/2020 20:03	07/12/2020 23:30	07/12/2020 20:03	07/12/2020 23:30	3,44	126	433,58	CHI
20201235976	CACHOEIRA ALTA	QI12279632	QUIRINOPOLIS	07/12/2020 20:03	08/12/2020 15:15	07/12/2020 20:03	08/12/2020 15:15	19,20	9	172,77	CHI
20201235976	QUIRINOPOLIS	QI12279632	QUIRINOPOLIS	07/12/2020 20:03	08/12/2020 15:15	07/12/2020 20:03	08/12/2020 15:15	19,20	2	38,39	CHI
20201235976	RIO VERDE	QI12279632	QUIRINOPOLIS	07/12/2020 20:03	08/12/2020 15:15	07/12/2020 20:03	08/12/2020 15:15	19,20	31	595,11	CHI
20201235688	CACHOEIRA DE GOIAS	CG21165618	FIRMINOPOLIS S2	07/12/2020 20:05	08/12/2020 11:00	07/12/2020 20:05	08/12/2020 11:00	14,90	1	14,90	CHI
20201235690	GOUVELANDIA	GB12303118	QUIRINOPOLIS	07/12/2020 20:07	08/12/2020 00:58	07/12/2020 20:07	08/12/2020 00:58	4,84	4	19,35	CHI
20201235701	MORRINHOS	MR11320271	MORRINHOS	07/12/2020 20:08	07/12/2020 21:22	07/12/2020 20:08	07/12/2020 21:22	1,22	277	339,02	CHI
20201235763	SENADOR CANEDO	SW11080241	GOIANIA LESTE S2	07/12/2020 20:08	07/12/2020 22:04	07/12/2020 20:08	07/12/2020 22:04	1,92	134	257,17	CHI
20201235774	JAUPACI	JP12123940	IPORA	07/12/2020 20:08	08/12/2020 00:32	07/12/2020 20:08	08/12/2020 00:32	4,39	12	52,66	CHI
20201235699	ABADIANIA	AA21297629	ANAPOLIS UNIVERSITARIO S1	07/12/2020 20:09	08/12/2020 10:33	07/12/2020 20:09	08/12/2020 10:33	14,40	2	28,80	CHI
20201235717	FIRMINOPOLIS	TV31145849	FIRMINOPOLIS S1	07/12/2020 20:12	07/12/2020 22:50	07/12/2020 20:12	07/12/2020 22:50	2,62	1	2,62	CHI
20201235726	ESTRELA DO NORTE	ET12231930	MARA ROSA	07/12/2020 20:12	07/12/2020 21:39	07/12/2020 20:12	07/12/2020 21:39	1,44	4	5,77	CHI
20201235729	MINEIROS	MY12278373	PARQUE DAS EMAS	07/12/2020 20:16	08/12/2020 19:40	07/12/2020 20:16	08/12/2020 19:40	23,39	5	116,96	CHI
20201235732	PORANGATU	PO12291266	PORANGATU	07/12/2020 20:17	08/12/2020 01:30	07/12/2020 20:17	08/12/2020 01:30	5,21	7	36,45	CHI
20201235737	ANICUNS	910059500	ANICUNS	07/12/2020 20:18	07/12/2020 22:58	07/12/2020 20:18	07/12/2020 22:58	2,66	1	2,66	CHI
20201235839	AGUAS LINDAS DE GOIAS	LA11149040	AGUAS LINDAS DE GOIAS S1	07/12/2020 20:18	07/12/2020 21:55	07/12/2020 20:18	07/12/2020 21:55	1,60	228	365,31	CHI
20201235749	AGUAS LINDAS DE GOIAS	LA11164955	AGUAS LINDAS DE GOIAS S1	07/12/2020 20:20	07/12/2020 21:38	07/12/2020 20:20	07/12/2020 21:38	1,29	214	276,24	CHI
20201235793	JAUPACI	JP12006114RE	IPORA	07/12/2020 20:20	08/12/2020 13:44	07/12/2020 20:20	08/12/2020 13:44	17,39	30	521,70	CHI
20201235837	BARRO ALTO	BA11055045	BARRO ALTO	07/12/2020 20:20	07/12/2020 22:39	07/12/2020 20:20	07/12/2020 22:39	2,31	169	390,20	CHI
20201235753	APARECIDA DE GOIANIA	AP11382799	INDEPENDENCIA S1	07/12/2020 20:21	07/12/2020 21:45	07/12/2020 20:21	07/12/2020 21:45	1,40	2	2,80	CHI
20201235757	ALTO PARAISO DE GOIAS	BF12245429	FLORES DE GOIAS	07/12/2020 20:21	08/12/2020 12:24	07/12/2020 20:21	08/12/2020 12:24	16,04	8	128,29	CHI
20201235757	SAO JOAO D ALIANCA	BF12245429	FLORES DE GOIAS	07/12/2020 20:21	08/12/2020 12:24	07/12/2020 20:21	08/12/2020 12:24	16,04	1	16,04	CHI
20201235758	MOZARLANDIA	MZ12307500	MOZARLANDIA	07/12/2020 20:21	08/12/2020 13:09	07/12/2020 20:21	08/12/2020 13:09	16,78	4	67,14	CHI
20201235964	LUZIANIA	LZ11217679	RIO VERMELHO	07/12/2020 20:21	07/12/2020 22:37	07/12/2020 20:21	07/12/2020 22:37	2,25	142	319,62	CHI
20201235994	APARECIDA DE GOIANIA	AP11154520	INDEPENDENCIA S2	07/12/2020 20:21	07/12/2020 22:36	07/12/2020 20:21	07/12/2020 22:36	2,25	128	287,96	CHI

20201235764	ESTRELA DO NORTE	SE12053814	MARA ROSA	07/12/2020 20:23	08/12/2020 09:43	07/12/2020 20:23	08/12/2020 09:43	13,35	3	40,04	CHI
20201235764	SANTA TEREZA DE GOIAS	SE12053814	MARA ROSA	07/12/2020 20:23	08/12/2020 09:43	07/12/2020 20:23	08/12/2020 09:43	13,35	4	53,39	CHI
20201235768	SANTA HELENA DE GOIAS	SH21156730	RIO VERDE S2	07/12/2020 20:23	07/12/2020 23:18	07/12/2020 20:23	07/12/2020 23:18	2,91	2	5,82	CHI
20201235775	SAO MIGUEL DO ARAGUAIA	SM21060840	SAO MIGUEL DO ARAGUAIA	07/12/2020 20:24	08/12/2020 10:40	07/12/2020 20:24	08/12/2020 10:40	14,26	1	14,26	CHI
20201235776	SENADOR CANEDO	190053616	SENADOR CANEDO	07/12/2020 20:24	08/12/2020 06:30	07/12/2020 20:24	08/12/2020 06:30	10,10	1	10,10	CHI
20201235780	CIDADE OCIDENTAL	10004861750	MARAJOARA	07/12/2020 20:25	07/12/2020 23:28	07/12/2020 20:25	07/12/2020 23:28	3,04	1	3,04	CHI
20201235789	RIO VERDE	RV21213292	MONTIVIDIU T	07/12/2020 20:26	07/12/2020 22:58	07/12/2020 20:26	07/12/2020 22:58	2,52	1	2,52	CHI
20201235959	URUACU	CR12164041	MARA ROSA	07/12/2020 20:26	07/12/2020 22:47	07/12/2020 20:26	07/12/2020 22:47	2,35	6	14,09	CHI
20201235959	CAMPINORTE	CR12164041	MARA ROSA	07/12/2020 20:26	07/12/2020 22:47	07/12/2020 20:26	07/12/2020 22:47	2,35	16	37,56	CHI
20201235803	IPORA	00850234	IPORA	07/12/2020 20:27	08/12/2020 17:30	07/12/2020 20:27	07/12/2020 22:46	2,32	99	229,27	CHI
20201235803	IPORA	00850234	IPORA	07/12/2020 20:27	08/12/2020 17:30	07/12/2020 20:27	07/12/2020 23:47	3,33	49	163,13	CHI
20201235803	IVOLANDIA	00850234	IPORA	07/12/2020 20:27	08/12/2020 17:30	07/12/2020 20:27	07/12/2020 23:47	3,33	14	46,61	CHI
20201235803	AMORINOPOLIS	00850234	IPORA	07/12/2020 20:27	08/12/2020 17:30	07/12/2020 20:27	07/12/2020 23:47	3,33	13	43,28	CHI
20201235803	IPORA	IR10409815	IPORA	07/12/2020 20:27	08/12/2020 17:30	08/12/2020 00:43	08/12/2020 00:50	0,11	148	16,53	CHI
20201235803	IVOLANDIA	IR10409815	IPORA	07/12/2020 20:27	08/12/2020 17:30	08/12/2020 00:43	08/12/2020 00:50	0,11	14	1,56	CHI
20201235803	AMORINOPOLIS	IR10409815	IPORA	07/12/2020 20:27	08/12/2020 17:30	08/12/2020 00:43	08/12/2020 00:50	0,11	13	1,45	CHI
20201235803	MOIPORA	00850234	IPORA	07/12/2020 20:27	08/12/2020 17:30	07/12/2020 20:27	08/12/2020 17:30	21,04	14	294,50	CHI
20201235803	IPORA	00850234	IPORA	07/12/2020 20:27	08/12/2020 17:30	07/12/2020 20:27	08/12/2020 17:30	21,04	5	105,18	CHI
20201235803	IVOLANDIA	00850234	IPORA	07/12/2020 20:27	08/12/2020 17:30	07/12/2020 20:27	08/12/2020 17:30	21,04	43	904,54	CHI
20201235941	VILA PROPICIO	BA12248765	BARRO ALTO	07/12/2020 20:27	08/12/2020 16:09	07/12/2020 20:27	08/12/2020 16:09	19,70	23	453,10	CHI
20201235805	JATAI	290282007	JATAI S2	07/12/2020 20:30	08/12/2020 20:45	07/12/2020 20:30	08/12/2020 20:45	24,25	1	24,25	CHI
20201235816	ITUMBIAIRA	IT21039587	CACHOEIRA DOURADA	07/12/2020 20:30	08/12/2020 10:09	07/12/2020 20:30	08/12/2020 10:09	13,64	1	13,64	CHI
20201235822	COLINAS DO SUL	TI21196544	MINACU	07/12/2020 20:31	08/12/2020 11:05	07/12/2020 20:31	08/12/2020 11:05	14,55	1	14,55	CHI
20201235828	BONOPOLIS	BX12292423	SAO MIGUEL DO ARAGUAIA	07/12/2020 20:32	08/12/2020 15:56	07/12/2020 20:32	08/12/2020 15:56	19,39	2	38,77	CHI
20201236406	MONTES CLAROS DE GOIAS	JR12212887	IPORA	07/12/2020 20:32	09/12/2020 12:37	07/12/2020 20:32	09/12/2020 12:37	40,07	7	280,49	CHI
20201236406	JUSSARA	JR12212887	IPORA	07/12/2020 20:32	09/12/2020 12:37	07/12/2020 20:32	09/12/2020 12:37	40,07	22	881,55	CHI
20201236905	JATAI	JT11379642	JATAI S2	07/12/2020 20:33	08/12/2020 10:31	07/12/2020 20:33	08/12/2020 10:31	13,97	8	111,72	CHI
20201235875	GOIANIA	GN11192024	ATLANTICO S1	07/12/2020 20:34	07/12/2020 22:00	07/12/2020 20:34	07/12/2020 22:00	1,43	68	97,43	CHI
20201235842	SANTO ANTONIO DO DESCOBERTO	SN21313996	MARAJOARA	07/12/2020 20:35	07/12/2020 23:10	07/12/2020 20:35	07/12/2020 23:10	2,57	1	2,57	CHI
20201235843	BURITINOPOLIS	MB12026276	IACIARA S2	07/12/2020 20:35	08/12/2020 01:28	07/12/2020 20:35	08/12/2020 01:28	4,87	2	9,74	CHI
20201235844	JATAI	290107880	JATAI S3	07/12/2020 20:36	08/12/2020 19:29	07/12/2020 20:36	08/12/2020 19:29	22,88	1	22,88	CHI
20201235845	INDIARA	C212011117	CEZARINA	07/12/2020 20:36	09/12/2020 21:10	07/12/2020 20:36	09/12/2020 21:10	48,57	3	145,70	CHI
20201235863	CUMARI	CY21231340	CATALAO S2	07/12/2020 20:40	08/12/2020 10:30	07/12/2020 20:40	08/12/2020 10:30	13,82	1	13,82	CHI
20201235901	ACREUNA	EU18260942TS	ACREUNA	07/12/2020 20:40	09/12/2020 11:58	07/12/2020 20:40	09/12/2020 11:58	39,31	18	707,54	CHI
20201235901	SANTO ANTONIO DA BARRA	EU18260942TS	ACREUNA	07/12/2020 20:40	09/12/2020 11:58	07/12/2020 20:40	09/12/2020 11:58	39,31	1	39,31	CHI
20201235865	BURITI ALEGRE	420044188	ITUMBIAIRA VELHA S2	07/12/2020 20:41	08/12/2020 12:11	07/12/2020 20:41	08/12/2020 12:11	15,49	1	15,49	CHI
20201235866	BONOPOLIS	BX12136924	SAO MIGUEL DO ARAGUAIA	07/12/2020 20:42	08/12/2020 15:56	07/12/2020 20:42	08/12/2020 15:56	19,24	3	57,71	CHI
20201235868	SANTA TEREZINHA DE GOIAS	SG21291243	SANTA TEREZINHA	07/12/2020 20:42	08/12/2020 16:12	07/12/2020 20:42	08/12/2020 16:12	19,49	1	19,49	CHI
20201235877	PALMEIRAS DE GOIAS	PL12063336	PALMEIRAS	07/12/2020 20:45	08/12/2020 00:00	07/12/2020 20:45	08/12/2020 00:00	3,25	10	32,49	CHI
20201235877	PALMINOPOLIS	PL12063336	PALMEIRAS	07/12/2020 20:45	08/12/2020 00:00	07/12/2020 20:45	08/12/2020 00:00	3,25	1	3,25	CHI
20201235907	SAO JOAO D ALIANCA	JL12404389	SAO JOAO D ALIANCA	07/12/2020 20:46	08/12/2020 08:59	07/12/2020 20:46	08/12/2020 08:59	12,22	7	85,51	CHI
20201235881	FORMOSA	FA21277565	ITUIQUIRA	07/12/2020 20:47	08/12/2020 12:55	07/12/2020 20:47	08/12/2020 12:55	16,13	4	64,52	CHI
20201235885	JOVIANIA	JV12073049	GOIATUBA S1	07/12/2020 20:47	08/12/2020 07:25	07/12/2020 20:47	08/12/2020 07:25	10,63	4	42,53	CHI
20201235885	GOIATUBA	JV12073049	GOIATUBA S1	07/12/2020 20:47	08/12/2020 07:25	07/12/2020 20:47	08/12/2020 07:25	10,63	2	21,27	CHI
20201235890	CORUMBA DE GOIAS	CB21317773	CORUMBA	07/12/2020 20:49	08/12/2020 04:28	07/12/2020 20:49	08/12/2020 04:28	7,64	1	7,64	CHI
20201235988	ITUMBIAIRA	BJ18392097TS	BOM JESUS DE GOIAS	07/12/2020 20:50	08/12/2020 11:48	07/12/2020 20:50	08/12/2020 11:48	14,95	67	1001,89	CHI
20201235988	BOM JESUS DE GOIAS	BJ18392097TS	BOM JESUS DE GOIAS	07/12/2020 20:50	08/12/2020 11:48	07/12/2020 20:50	08/12/2020 11:48	14,95	2	29,91	CHI
20201233578	INDIARA	EA12257973	EDEIA	07/12/2020 20:51	07/12/2020 22:49	07/12/2020 20:51	07/12/2020 22:49	1,97	7	13,77	CHI
20201233578	EDEIA	EA12257973	EDEIA	07/12/2020 20:51	07/12/2020 22:49	07/12/2020 20:51	07/12/2020 22:49	1,97	33	64,90	CHI
20201233578	ACREUNA	EA12257973	EDEIA	07/12/2020 20:51	07/12/2020 22:49	07/12/2020 20:51	07/12/2020 22:49	1,97	13	25,57	CHI
20201235902	GOIANIA	GN11233011	GOIANIA LESTE S3	07/12/2020 20:53	07/12/2020 22:29	07/12/2020 20:53	07/12/2020 22:29	1,59	25	39,73	CHI

20201235910	ARAGOIANIA	AO11379530	GUAPO S2	07/12/2020 20:56	07/12/2020 22:06	07/12/2020 20:56	07/12/2020 22:06	1,17	15	17,50	CHI
20201235912	APARECIDA DE GOIANIA	14416001	REAL S2	07/12/2020 20:56	08/12/2020 08:05	07/12/2020 20:56	08/12/2020 08:05	11,15	1	11,15	CHI
20201235919	VILA PROPICIO	PV21398304	GOIANESIA S1	07/12/2020 20:56	08/12/2020 18:38	07/12/2020 20:56	08/12/2020 18:38	21,68	1	21,68	CHI
20201235953	NIQUELANDIA	NQ12095769	NIQUELANDIA SUBTRANSMISSAO	07/12/2020 20:56	07/12/2020 22:38	07/12/2020 20:56	07/12/2020 22:38	1,70	3	5,10	CHI
20201235993	JATAI	JT12205186	JATAI S1	07/12/2020 20:56	08/12/2020 01:07	07/12/2020 20:56	08/12/2020 01:07	4,17	7	29,17	CHI
20201236000	ORIZONA	OZ12114505	PIRES DO RIO S2	07/12/2020 20:56	08/12/2020 08:22	07/12/2020 20:56	08/12/2020 08:22	11,42	20	228,44	CHI
20201235922	SANTA CRUZ DE GOIAS	BC12300692	PIRES DO RIO S2	07/12/2020 20:57	08/12/2020 10:30	07/12/2020 20:57	08/12/2020 10:30	13,55	10	135,49	CHI
20201235924	AMORINOPOLIS	AM21362193	IPORA	07/12/2020 20:57	08/12/2020 19:27	07/12/2020 20:57	08/12/2020 19:27	22,48	2	44,97	CHI
20201236002	GOIANIA	GN11002402	CARAJAS S1	07/12/2020 21:03	07/12/2020 21:03	07/12/2020 21:03	07/12/2020 21:03	1,46	140	204,67	CHI
20201235946	GOIANIA	GN11160991	REAL S1	07/12/2020 21:04	08/12/2020 01:15	07/12/2020 21:04	08/12/2020 01:15	4,18	130	543,54	CHI
20201235950	MORRINHOS	MR11000061	MORRINHOS	07/12/2020 21:04	08/12/2020 03:24	07/12/2020 21:04	08/12/2020 03:24	6,32	206	1301,52	CHI
20201235947	ALOANDIA	AD21216344	GOIATUBA S1	07/12/2020 21:08	07/12/2020 21:34	07/12/2020 21:08	07/12/2020 21:34	0,42	2	0,84	CHI
20201235949	CACU	CC21305851	CACHOEIRA ALTA	07/12/2020 21:09	08/12/2020 01:40	07/12/2020 21:09	08/12/2020 01:40	4,51	1	4,51	CHI
20201235961	JOVIANIA	JV12050204	VICENTINOPOLIS	07/12/2020 21:10	08/12/2020 10:28	07/12/2020 21:10	08/12/2020 10:28	13,29	2	26,57	CHI
20201235961	PONTALINA	JV12050204	VICENTINOPOLIS	07/12/2020 21:10	08/12/2020 10:28	07/12/2020 21:10	08/12/2020 10:28	13,29	26	345,41	CHI
20201236697	AMORINOPOLIS	AM12091444	IPORA	07/12/2020 21:10	08/12/2020 12:35	07/12/2020 21:10	08/12/2020 12:35	15,41	16	246,50	CHI
20201235956	GOIANIA	10003434263	PLANATICO S1	07/12/2020 21:12	07/12/2020 22:27	07/12/2020 21:12	07/12/2020 22:27	1,25	1	1,25	CHI
20201235977	PORTELANDIA	PW12303420	PARQUE DAS EMAS	07/12/2020 21:13	08/12/2020 00:30	07/12/2020 21:13	08/12/2020 00:30	3,27	14	45,79	CHI
20201235983	PLANALTINA	PI11146248	PLANALTINA	07/12/2020 21:13	08/12/2020 01:47	07/12/2020 21:13	08/12/2020 01:47	4,56	432	1970,52	CHI
20201235965	AMORINOPOLIS	AM21165774	IPORA	07/12/2020 21:14	08/12/2020 11:17	07/12/2020 21:14	08/12/2020 11:17	14,05	1	14,05	CHI
20201235967	PIRENOPOLIS	PV21399392	CORUMBA	07/12/2020 21:14	08/12/2020 00:59	07/12/2020 21:14	08/12/2020 00:59	3,75	1	3,75	CHI
20201235968	PORTEIRAO	CL21295999	RIO DOS BOIS	07/12/2020 21:14	08/12/2020 11:08	07/12/2020 21:14	08/12/2020 11:08	13,89	1	13,89	CHI
20201235975	CORUMBA DE GOIAS	260009805	CORUMBA	07/12/2020 21:17	08/12/2020 03:50	07/12/2020 21:17	08/12/2020 03:50	6,55	1	6,55	CHI
20201235978	JATAI	AW21342532	CACHOEIRA ALTA	07/12/2020 21:18	08/12/2020 20:52	07/12/2020 21:18	08/12/2020 20:52	23,55	1	23,55	CHI
20201235984	SITIO D ABADIA	FB11285742	IACIARA S2	07/12/2020 21:20	07/12/2020 22:53	07/12/2020 21:20	07/12/2020 22:53	1,54	2	3,07	CHI
20201235990	ITAPURANGA	IK12300249	ITAPURANGA	07/12/2020 21:23	08/12/2020 08:24	07/12/2020 21:23	08/12/2020 08:24	11,00	5	55,01	CHI
20201235991	FLORES DE GOIAS	3480006599	FLORES DE GOIAS	07/12/2020 21:24	08/12/2020 19:10	07/12/2020 21:24	08/12/2020 19:10	21,77	1	21,77	CHI
20201235995	GOIAS	GS21310773	GOIAS	07/12/2020 21:24	08/12/2020 02:21	07/12/2020 21:24	08/12/2020 02:21	4,94	1	4,94	CHI
20201235997	APARECIDA DE GOIANIA	10009493156	INDEPENDENCIA S2	07/12/2020 21:25	07/12/2020 22:14	07/12/2020 21:25	07/12/2020 22:14	0,80	1	0,80	CHI
20201235999	PIRACANJUBA	PJ12000215	PIRACANJUBA	07/12/2020 21:26	08/12/2020 13:53	07/12/2020 21:26	08/12/2020 13:53	16,44	55	904,23	CHI
20201237370	FORMOSA	FA11000046	ITUIQUIRA	07/12/2020 21:28	08/12/2020 10:05	07/12/2020 21:28	08/12/2020 10:05	12,63	29	366,28	CHI
20201236487	MAIRIPOTABA	PK12390276	PONTALINA	07/12/2020 21:29	08/12/2020 08:30	07/12/2020 21:29	08/12/2020 08:30	11,01	55	605,58	CHI
20201238153	FORMOSO	ET12168852	MARA ROSA	07/12/2020 21:32	08/12/2020 11:47	07/12/2020 21:32	08/12/2020 11:47	14,24	2	28,48	CHI
20201238153	ESTRELA DO NORTE	ET12168852	MARA ROSA	07/12/2020 21:32	08/12/2020 11:47	07/12/2020 21:32	08/12/2020 11:47	14,24	4	56,95	CHI
20201236015	CACU	CC12028258	CACHOEIRA ALTA	07/12/2020 21:34	08/12/2020 03:05	07/12/2020 21:34	08/12/2020 03:05	5,50	59	324,55	CHI
20201236015	QUIRINOPOLIS	CC12028258	CACHOEIRA ALTA	07/12/2020 21:34	08/12/2020 03:05	07/12/2020 21:34	08/12/2020 03:05	5,50	1	5,50	CHI
20201236016	GOIANIA	11737232	REAL S1	07/12/2020 21:35	07/12/2020 23:21	07/12/2020 21:35	07/12/2020 23:21	1,76	1	1,76	CHI
20201236019	CACU	CC21227956	CACHOEIRA ALTA	07/12/2020 21:35	08/12/2020 03:33	07/12/2020 21:35	08/12/2020 03:33	5,96	1	5,96	CHI
20201236148	VALPARAISO DE GOIAS	VA11370780	PACAEMBU S2	07/12/2020 21:36	07/12/2020 23:05	07/12/2020 21:36	07/12/2020 23:05	1,48	72	106,28	CHI
20201236025	PIRENOPOLIS	PV21122851	SAO FRANCISCO DE GOIAS	07/12/2020 21:37	08/12/2020 09:57	07/12/2020 21:37	08/12/2020 09:57	12,32	1	12,32	CHI
20201236240	ABADIANIA	AA12390217	ANAPOLIS UNIVERSITARIO S1	07/12/2020 21:37	08/12/2020 00:22	07/12/2020 21:37	08/12/2020 00:22	2,75	10	27,46	CHI
20201236028	INACIOLANDIA	CD21000087	CACHOEIRA DOURADA	07/12/2020 21:38	08/12/2020 02:12	07/12/2020 21:38	08/12/2020 02:12	4,55	1	4,55	CHI
20201236031	AGUA FRIA DE GOIAS	TL12342387	SAO JOAO D ALIANCA	07/12/2020 21:40	08/12/2020 10:05	07/12/2020 21:40	08/12/2020 10:05	12,41	1	12,41	CHI
20201236032	ITAGUARI	II12300335	ITABERAI S1	07/12/2020 21:40	08/12/2020 12:51	07/12/2020 21:40	08/12/2020 12:51	15,18	2	30,36	CHI
20201236033	AGUAS LINDAS DE GOIAS	10016274944	AGUAS LINDAS DE GOIAS S1	07/12/2020 21:41	07/12/2020 23:23	07/12/2020 21:41	07/12/2020 23:23	1,70	1	1,70	CHI
20201236552	GOIANESIA	GE12322006	GOIANESIA S1	07/12/2020 21:41	08/12/2020 08:33	07/12/2020 21:41	08/12/2020 08:33	10,85	7	75,98	CHI
20201236552	SANTA RITA DO NOVO DESTINO	GE12322006	GOIANESIA S1	07/12/2020 21:41	08/12/2020 08:33	07/12/2020 21:41	08/12/2020 08:33	10,85	8	86,84	CHI
20201236096	SAO SIMAO	00270414	CACHOEIRA ALTA	07/12/2020 21:43	09/12/2020 01:44	08/12/2020 00:39	08/12/2020 00:45	0,09	6	0,53	CHI
20201236096	SAO SIMAO	00270414	CACHOEIRA ALTA	07/12/2020 21:43	09/12/2020 01:44	08/12/2020 00:39	08/12/2020 00:45	0,09	7	0,62	CHI
20201236096	CACU	00270414	CACHOEIRA ALTA	07/12/2020 21:43	09/12/2020 01:44	08/12/2020 00:39	08/12/2020 00:45	0,09	1	0,09	CHI
20201236096	SAO SIMAO	00270414	CACHOEIRA ALTA	07/12/2020 21:43	09/12/2020 01:44	08/12/2020 00:39	08/12/2020 00:45	0,09	8	0,71	CHI

20201236096	SAO SIMAO	00270414	CACHOEIRA ALTA	07/12/2020 21:43	09/12/2020 01:44	08/12/2020 00:39	08/12/2020 00:45	0,09	634	56,00	CHI
20201236096	PARANAIGUARA	00270414	CACHOEIRA ALTA	07/12/2020 21:43	09/12/2020 01:44	08/12/2020 00:39	08/12/2020 00:45	0,09	2503	221,10	CHI
20201236096	PARANAIGUARA	00270414	CACHOEIRA ALTA	07/12/2020 21:43	09/12/2020 01:44	08/12/2020 00:39	08/12/2020 00:45	0,09	1268	112,01	CHI
20201236096	CACHOEIRA ALTA	00270414	CACHOEIRA ALTA	07/12/2020 21:43	09/12/2020 01:44	08/12/2020 00:39	08/12/2020 00:45	0,09	15	1,33	CHI
20201236096	PARANAIGUARA	00270414	CACHOEIRA ALTA	07/12/2020 21:43	09/12/2020 01:44	08/12/2020 00:39	08/12/2020 00:45	0,09	2	0,18	CHI
20201236096	CACU	00270414	CACHOEIRA ALTA	07/12/2020 21:43	09/12/2020 01:44	08/12/2020 00:39	08/12/2020 00:45	0,09	98	8,66	CHI
20201236096	PARANAIGUARA	00270414	CACHOEIRA ALTA	07/12/2020 21:43	09/12/2020 01:44	08/12/2020 00:39	08/12/2020 00:45	0,09	136	12,01	CHI
20201236096	SAO SIMAO	SO16408215	CACHOEIRA ALTA	07/12/2020 21:43	09/12/2020 01:44	08/12/2020 00:39	08/12/2020 01:15	0,59	53	31,33	CHI
20201236096	SAO SIMAO	PC13234528	CACHOEIRA ALTA	07/12/2020 21:43	09/12/2020 01:44	08/12/2020 00:37	08/12/2020 02:02	1,41	31	43,67	CHI
20201236096	SAO SIMAO	SO10396888	CACHOEIRA ALTA	07/12/2020 21:43	09/12/2020 01:44	08/12/2020 02:07	09/12/2020 01:44	23,61	31	732,04	CHI
20201236050	TRINDADE	10022797104	TRINDADE	07/12/2020 21:46	08/12/2020 02:07	07/12/2020 21:46	08/12/2020 02:07	4,34	1	4,34	CHI
20201236051	ITUMBIARA	IT12257179RE	BOM JESUS DE GOIAS	07/12/2020 21:47	08/12/2020 19:16	07/12/2020 21:47	08/12/2020 19:16	21,49	1	21,49	CHI
20201236080	PORANGATU	PO12374520	PORANGATU	07/12/2020 21:49	08/12/2020 07:27	07/12/2020 21:49	08/12/2020 07:27	9,63	19	182,91	CHI
20201236080	MUTUNOPOLIS	PO12374520	PORANGATU	07/12/2020 21:49	08/12/2020 07:27	07/12/2020 21:49	08/12/2020 07:27	9,63	20	192,53	CHI
20201236068	MOSSAMEDES	MD12188234	FIRMINOPOLIS S2	07/12/2020 21:50	08/12/2020 01:04	07/12/2020 21:50	08/12/2020 01:04	3,22	34	109,57	CHI
20201236269	BURITI ALEGRE	BG12120881	ITUMBIARA VELHA S2	07/12/2020 21:50	08/12/2020 09:12	07/12/2020 21:50	08/12/2020 09:12	11,36	15	170,46	CHI
20201236269	GOIATUBA	BG12120881	ITUMBIARA VELHA S2	07/12/2020 21:50	08/12/2020 09:12	07/12/2020 21:50	08/12/2020 09:12	11,36	2	22,73	CHI
20201236551	MARA ROSA	MQ12263046	MARA ROSA	07/12/2020 21:55	08/12/2020 07:37	07/12/2020 21:55	08/12/2020 07:37	9,69	7	67,81	CHI
20201236100	FORMOSO	ET12143681	MARA ROSA	07/12/2020 22:00	08/12/2020 10:54	07/12/2020 22:00	08/12/2020 10:54	12,89	13	167,57	CHI
20201236103	ABADIANIA	AA21090315	ANAPOLIS UNIVERSITARIO S1	07/12/2020 22:02	07/12/2020 23:46	07/12/2020 22:02	07/12/2020 23:46	1,73	1	1,73	CHI
20201236112	ITABERAI	IB21210460	ITABERAI S1	07/12/2020 22:05	07/12/2020 23:08	07/12/2020 22:05	07/12/2020 23:08	1,04	1	1,04	CHI
20201236114	GOIAS	GS12259605	GOIAS	07/12/2020 22:05	08/12/2020 04:17	07/12/2020 22:05	08/12/2020 04:17	6,18	2	12,37	CHI
20201236121	CACHOEIRA ALTA	CA21075245	CACHOEIRA ALTA	07/12/2020 22:07	08/12/2020 02:34	07/12/2020 22:07	08/12/2020 02:34	4,44	1	4,44	CHI
20201236126	ANAPOLIS	20997127	ANAPOLIS UNIVERSITARIO S2	07/12/2020 22:09	08/12/2020 00:02	07/12/2020 22:09	08/12/2020 00:02	1,88	1	1,88	CHI
20201236159	EDEIA	EA13372706	EDEIA	07/12/2020 22:10	08/12/2020 02:15	07/12/2020 22:10	08/12/2020 02:15	4,08	63	256,87	CHI
20201236159	EDEIA	EA13372706	EDEIA	07/12/2020 22:10	08/12/2020 02:15	08/12/2020 01:20	08/12/2020 02:15	0,91	12	10,96	CHI
20201236143	PANAMA	PX12008278	GOIATUBA S1	07/12/2020 22:13	08/12/2020 00:21	07/12/2020 22:13	08/12/2020 00:21	2,13	6	12,75	CHI
20201236143	GOIATUBA	PX12008278	GOIATUBA S1	07/12/2020 22:13	08/12/2020 00:21	07/12/2020 22:13	08/12/2020 00:21	2,13	9	19,13	CHI
20201236149	APARECIDA DE GOIANIA	200568668	INDEPENDENCIA S2	07/12/2020 22:15	08/12/2020 02:37	07/12/2020 22:15	08/12/2020 02:37	4,36	1	4,36	CHI
20201236152	GOIANIA	10350860	CAMPINAS S1	07/12/2020 22:16	08/12/2020 03:44	07/12/2020 22:16	08/12/2020 03:44	5,47	1	5,47	CHI
20201236212	FAINA	FC12299839	GOIAS	07/12/2020 22:18	08/12/2020 07:20	07/12/2020 22:18	08/12/2020 07:20	9,02	14	126,31	CHI
20201236499	SANTA FE DE GOIAS	IU12018758	MATRINCHA	07/12/2020 22:18	08/12/2020 12:14	07/12/2020 22:18	08/12/2020 12:14	13,92	12	167,02	CHI
20201236166	BONFINOPOLIS	BO12400465	CEPAIGO S2	07/12/2020 22:19	08/12/2020 07:28	07/12/2020 22:19	08/12/2020 07:28	9,14	3	27,43	CHI
20201236166	LEOPOLDO DE BULHOES	BO12400465	CEPAIGO S2	07/12/2020 22:19	08/12/2020 07:28	07/12/2020 22:19	08/12/2020 07:28	9,14	12	109,70	CHI
20201236183	URUTAI	UT12016946	URUTAI	07/12/2020 22:24	08/12/2020 01:24	07/12/2020 22:24	08/12/2020 01:24	2,98	2	5,97	CHI
20201236187	AMARALINA	MQ12050047	MARA ROSA	07/12/2020 22:25	07/12/2020 23:41	07/12/2020 22:25	07/12/2020 23:41	1,26	233	293,39	CHI
20201236192	SANTO ANTONIO DA BARRA	BZ12428466	ACREUNA	07/12/2020 22:27	07/12/2020 23:47	07/12/2020 22:27	07/12/2020 23:47	1,35	13	17,49	CHI
20201236193	GOIANIA	GN11001282	CAMPINAS S3	07/12/2020 22:27	08/12/2020 03:49	07/12/2020 22:27	08/12/2020 03:49	5,35	34	181,93	CHI
20201236221	APARECIDA DE GOIANIA	AP11153671	INDEPENDENCIA S2	07/12/2020 22:30	08/12/2020 00:38	07/12/2020 22:30	08/12/2020 00:38	2,13	188	400,39	CHI
20201236706	BURITINOPOLIS	BQ12168775	IACIARA S2	07/12/2020 22:30	08/12/2020 10:17	07/12/2020 22:30	08/12/2020 10:17	11,77	40	470,86	CHI
20201236764	DAMIANOPOLIS	DA12196513	IACIARA S2	07/12/2020 22:31	08/12/2020 07:56	07/12/2020 22:31	08/12/2020 07:56	9,40	61	573,60	CHI
20201236226	MORRINHOS	MR10406908	MORRINHOS	07/12/2020 22:33	09/12/2020 14:16	07/12/2020 22:33	08/12/2020 03:47	5,24	53	277,68	CHI
20201236226	MORRINHOS	MR13212185	MORRINHOS	07/12/2020 22:33	09/12/2020 14:16	07/12/2020 22:33	08/12/2020 09:17	10,73	4	42,92	CHI
20201236226	MORRINHOS	MR12182765LD	MORRINHOS	07/12/2020 22:33	09/12/2020 14:16	07/12/2020 22:33	08/12/2020 11:03	12,49	14	174,89	CHI
20201236226	MORRINHOS	MR10406908	MORRINHOS	07/12/2020 22:33	09/12/2020 14:16	08/12/2020 11:03	08/12/2020 11:30	0,44	57	25,19	CHI
20201236226	MORRINHOS	MR10406908	MORRINHOS	07/12/2020 22:33	09/12/2020 14:16	08/12/2020 17:23	08/12/2020 18:01	0,63	57	35,89	CHI
20201236226	MORRINHOS	MR12182765LD	MORRINHOS	07/12/2020 22:33	09/12/2020 14:16	07/12/2020 22:33	09/12/2020 14:16	39,72	7	278,03	CHI
20201236226	IPAMERI	MR12182765LD	MORRINHOS	07/12/2020 22:33	09/12/2020 14:16	07/12/2020 22:33	09/12/2020 14:16	39,72	1	39,72	CHI
20201236226	MORRINHOS	MR12182765LD	MORRINHOS	07/12/2020 22:33	09/12/2020 14:16	08/12/2020 11:16	09/12/2020 14:16	27,01	14	378,08	CHI
20201236223	ITABERAI	IB21310510	ITABERAI S1	07/12/2020 22:35	08/12/2020 08:47	07/12/2020 22:35	08/12/2020 08:47	10,19	1	10,19	CHI
20201236235	SANCLERLANDIA	SC12204364	FIRMINOPOLIS S2	07/12/2020 22:39	08/12/2020 02:51	07/12/2020 22:39	08/12/2020 02:51	4,19	2	8,39	CHI

20201236241	RIO VERDE	RV11360715	RIO VERDE S2	07/12/2020 22:43	08/12/2020 00:10	07/12/2020 22:43	08/12/2020 00:10	1,45	107	154,91	CHI
20201236248	LUZIANIA	10001449069	RIO VERMELHO	07/12/2020 22:48	08/12/2020 02:04	07/12/2020 22:48	08/12/2020 02:04	3,26	1	3,26	CHI
20201236252	GOIATUBA	BJ12392127	BOM JESUS DE GOIAS	07/12/2020 22:49	08/12/2020 05:41	07/12/2020 22:49	08/12/2020 05:41	6,85	4	27,41	CHI
20201236260	PORANGATU	PO12350110	PORANGATU	07/12/2020 22:50	08/12/2020 01:01	07/12/2020 22:50	08/12/2020 01:01	2,17	17	36,96	CHI
20201236299	SIMOLANDIA	SA12168083	IACIARA S2	07/12/2020 22:50	08/12/2020 02:14	07/12/2020 22:50	08/12/2020 02:14	3,40	40	135,88	CHI
20201236257	HIDROLANDIA	180009722	PONTALINA	07/12/2020 22:51	08/12/2020 00:55	07/12/2020 22:51	08/12/2020 00:55	2,07	1	2,07	CHI
20201236264	RIO VERDE	RV11360714	RIO VERDE S2	07/12/2020 22:57	08/12/2020 04:24	07/12/2020 22:57	08/12/2020 04:24	5,44	112	609,03	CHI
20201236265	DISTRITO FEDERAL	CT12358435RE	CATALAO S1	07/12/2020 22:57	08/12/2020 09:16	07/12/2020 22:57	08/12/2020 09:16	10,30	1	10,30	CHI
20201236265	CATALAO	CT12358435RE	CATALAO S1	07/12/2020 22:57	08/12/2020 09:16	07/12/2020 22:57	08/12/2020 09:16	10,30	6	61,81	CHI
20201236268	JATAI	JT12378104B	JATAI S2	07/12/2020 22:59	08/12/2020 05:41	07/12/2020 22:59	08/12/2020 05:41	6,71	304	2040,94	CHI
20201236268	RIO VERDE	JT12378104B	JATAI S2	07/12/2020 22:59	08/12/2020 05:41	07/12/2020 22:59	08/12/2020 05:41	6,71	33	221,55	CHI
20201236271	MINACU	IH11182312	MINACU	07/12/2020 23:00	08/12/2020 03:05	07/12/2020 23:00	08/12/2020 03:05	4,07	1	4,07	CHI
20201236272	QUIRINOPOLIS	QI12064734	QUIRINOPOLIS	07/12/2020 23:03	08/12/2020 16:50	07/12/2020 23:03	08/12/2020 16:50	17,78	1	17,78	CHI
20201236281	JARAGUA	JA10396200	JARAGUA	07/12/2020 23:05	08/12/2020 13:13	07/12/2020 23:09	08/12/2020 02:27	3,29	104	342,36	CHI
20201236281	JARAGUA	JA10396200	JARAGUA	07/12/2020 23:05	08/12/2020 13:13	08/12/2020 07:19	08/12/2020 07:33	0,24	104	25,34	CHI
20201236281	ITAGUARU	JA10396200	JARAGUA	07/12/2020 23:05	08/12/2020 13:13	07/12/2020 23:09	08/12/2020 08:13	9,06	9	81,54	CHI
20201236281	JARAGUA	JA10396200	JARAGUA	07/12/2020 23:05	08/12/2020 13:13	07/12/2020 23:09	08/12/2020 08:13	9,06	99	896,91	CHI
20201236281	JARAGUA	JA10396200	JARAGUA	07/12/2020 23:05	08/12/2020 13:13	07/12/2020 23:09	08/12/2020 13:13	14,06	177	2488,96	CHI
20201236281	URUJANA	JA10396200	JARAGUA	07/12/2020 23:05	08/12/2020 13:13	07/12/2020 23:09	08/12/2020 13:13	14,06	7	98,43	CHI
20201236281	ITAGUARU	JA10396200	JARAGUA	07/12/2020 23:05	08/12/2020 13:13	07/12/2020 23:09	08/12/2020 13:13	14,06	17	239,05	CHI
20201236278	LUZIANIA	KR12080375	PAMPLONA	07/12/2020 23:07	08/12/2020 03:55	07/12/2020 23:07	08/12/2020 03:55	4,80	1	4,80	CHI
20201236287	GOIANIA	GN11000794	GOIANIA LESTE S3	07/12/2020 23:11	08/12/2020 04:47	07/12/2020 23:11	08/12/2020 04:47	5,59	159	888,54	CHI
20201236335	NEROPOLIS	NR11187209	NEROPOLIS S2	07/12/2020 23:12	08/12/2020 02:36	07/12/2020 23:12	08/12/2020 02:36	3,40	177	601,31	CHI
20201236623	GOIANESIA	GE12215070	GOIANESIA S1	07/12/2020 23:13	08/12/2020 10:03	07/12/2020 23:13	08/12/2020 10:03	10,82	24	259,63	CHI
20201236293	GOIANIA	10020417274	REAL S1	07/12/2020 23:14	08/12/2020 01:09	07/12/2020 23:14	08/12/2020 01:09	1,91	1	1,91	CHI
20201236295	FLORES DE GOIAS	FB21334129	FLORES DE GOIAS	07/12/2020 23:20	09/12/2020 16:46	07/12/2020 23:20	09/12/2020 16:46	41,43	1	41,43	CHI
20201236304	APARECIDA DE GOIANIA	AP11164446	REAL S1	07/12/2020 23:29	08/12/2020 02:50	07/12/2020 23:29	08/12/2020 02:50	3,34	143	477,90	CHI
20201236310	SERRANOPOLIS	SX12390581	JATAI S1	07/12/2020 23:34	08/12/2020 11:34	07/12/2020 23:34	08/12/2020 11:34	11,99	6	71,93	CHI
20201236538	EDEIA	EA12352545	EDEIA	07/12/2020 23:37	08/12/2020 08:06	07/12/2020 23:37	08/12/2020 08:06	8,48	3	25,43	CHI
20201236538	INDIARA	EA12352545	EDEIA	07/12/2020 23:37	08/12/2020 08:06	07/12/2020 23:37	08/12/2020 08:06	8,48	20	169,56	CHI
20201236314	IPAMERI	IP21359965	PIRES DO RIO S2	07/12/2020 23:38	08/12/2020 10:59	07/12/2020 23:38	08/12/2020 10:59	11,34	1	11,34	CHI
20201236315	BELA VISTA DE GOIAS	BV12011703	BELA VISTA S1	07/12/2020 23:40	08/12/2020 01:38	07/12/2020 23:40	08/12/2020 01:38	1,96	8	15,65	CHI
20201236317	FORMOSO	FO21145436	MARA ROSA	07/12/2020 23:44	08/12/2020 13:52	07/12/2020 23:44	08/12/2020 13:52	14,13	1	14,13	CHI
202012133153	ACREUNA	BZ10420054	ACREUNA	07/12/2020 23:44	09/12/2020 15:25	08/12/2020 01:14	08/12/2020 01:39	0,43	3	1,28	CHI
202012133153	SANTO ANTONIO DA BARRA	BZ10420054	ACREUNA	07/12/2020 23:44	09/12/2020 15:25	08/12/2020 01:14	08/12/2020 01:39	0,43	14	5,98	CHI
202012133153	ACREUNA	EU12214067	ACREUNA	07/12/2020 23:44	09/12/2020 15:25	08/12/2020 02:43	08/12/2020 04:00	1,29	52	66,91	CHI
202012133153	ACREUNA	EU13111123	ACREUNA	07/12/2020 23:44	09/12/2020 15:25	08/12/2020 11:15	08/12/2020 22:18	11,06	61	674,49	CHI
202012133153	ACREUNA	EU13111123	ACREUNA	07/12/2020 23:44	09/12/2020 15:25	09/12/2020 08:01	09/12/2020 12:56	4,90	9	44,14	CHI
202012133153	ACREUNA	EU12214067	ACREUNA	07/12/2020 23:44	09/12/2020 15:25	09/12/2020 00:16	09/12/2020 14:30	14,23	52	740,08	CHI
202012133153	ACREUNA	EU13111122	ACREUNA	07/12/2020 23:44	09/12/2020 15:25	09/12/2020 15:05	09/12/2020 15:25	0,33	3	1,00	CHI
202012133153	SANTO ANTONIO DA BARRA	EU13111122	ACREUNA	07/12/2020 23:44	09/12/2020 15:25	09/12/2020 15:05	09/12/2020 15:25	0,33	14	4,66	CHI
20201236513	PADRE BERNARDO	ZN12089830	COCALZINHO	07/12/2020 23:48	08/12/2020 13:58	07/12/2020 23:48	08/12/2020 13:58	14,16	1	14,16	CHI
20201236513	COCALZINHO DE GOIAS	ZN12089830	COCALZINHO	07/12/2020 23:48	08/12/2020 13:58	07/12/2020 23:48	08/12/2020 13:58	14,16	10	141,62	CHI
20201236323	PILAR DE GOIAS	GG12318427	URUACU	07/12/2020 23:49	08/12/2020 05:02	07/12/2020 23:49	08/12/2020 05:02	5,20	10	52,01	CHI
20201236328	CACHOEIRA ALTA	CA12075312	CACHOEIRA ALTA	08/12/2020 00:01	08/12/2020 05:50	08/12/2020 00:01	08/12/2020 05:50	5,81	3	17,42	CHI
20201236556	QUIRINOPOLIS	QI12101226	QUIRINOPOLIS	08/12/2020 00:02	08/12/2020 10:11	08/12/2020 00:02	08/12/2020 10:11	10,14	18	182,50	CHI
20201236624	QUIRINOPOLIS	QI32017987	QUIRINOPOLIS	08/12/2020 00:02	08/12/2020 09:08	08/12/2020 00:02	08/12/2020 09:08	9,09	11	99,96	CHI
20201236337	NAZARIO	NZ21076353	ANICUNS	08/12/2020 00:15	08/12/2020 08:03	08/12/2020 00:15	08/12/2020 08:03	7,79	4	31,16	CHI
20201236566	PARANAIGUARA	PC12000120	QUIRINOPOLIS	08/12/2020 00:29	08/12/2020 08:07	08/12/2020 00:29	08/12/2020 08:07	7,62	81	617,15	CHI
20201236566	QUIRINOPOLIS	PC12000120	QUIRINOPOLIS	08/12/2020 00:29	08/12/2020 08:07	08/12/2020 00:29	08/12/2020 08:07	7,62	5	38,10	CHI
20201236351	SAO SIMAO	10022575730	CACHOEIRA ALTA	08/12/2020 00:42	08/12/2020 04:45	08/12/2020 00:42	08/12/2020 04:45	4,04	1	4,04	CHI

20201236498	INDIARA	EA12257973	EDEIA	08/12/2020 01:05	08/12/2020 07:56	08/12/2020 01:05	08/12/2020 07:56	6,85	7	47,92	CHI
20201236498	EDEIA	EA12257973	EDEIA	08/12/2020 01:05	08/12/2020 07:56	08/12/2020 01:05	08/12/2020 07:56	6,85	33	225,91	CHI
20201236498	ACREUNA	EA12257973	EDEIA	08/12/2020 01:05	08/12/2020 07:56	08/12/2020 01:05	08/12/2020 07:56	6,85	13	89,00	CHI
20201236358	ANAPOLIS	21283308	ANAPOLIS UNIVERSITARIO S2	08/12/2020 01:07	08/12/2020 02:09	08/12/2020 01:07	08/12/2020 02:09	1,03	1	1,03	CHI
20201236359	ANAPOLIS	AN12261185	ANAPOLIS UNIVERSITARIO S2	08/12/2020 01:08	08/12/2020 02:26	08/12/2020 01:08	08/12/2020 02:26	1,29	12	15,54	CHI
20201236361	JARAGUA	JA12234242	JARAGUA	08/12/2020 01:19	08/12/2020 15:20	08/12/2020 01:19	08/12/2020 15:20	14,02	15	210,23	CHI
20201236362	RIO VERDE	RV11360708	RIO VERDE S2	08/12/2020 01:26	08/12/2020 03:00	08/12/2020 01:26	08/12/2020 03:00	1,56	199	310,05	CHI
20201236393	BALIZA	BH12334823	BOM JARDIM	08/12/2020 01:26	08/12/2020 15:38	08/12/2020 01:26	08/12/2020 15:38	14,19	201	2852,30	CHI
20201236393	BALIZA	BH12334823	BOM JARDIM	08/12/2020 01:26	08/12/2020 15:38	08/12/2020 08:51	08/12/2020 15:38	6,79	2	13,58	CHI
20201236367	BONOPOLIS	BX12168214	SAO MIGUEL DO ARAGUAIA	08/12/2020 01:44	08/12/2020 10:20	08/12/2020 01:44	08/12/2020 10:20	8,59	124	1065,40	CHI
20201236368	ABADIANIA	AA12291825	ANAPOLIS UNIVERSITARIO S1	08/12/2020 01:52	08/12/2020 11:10	08/12/2020 01:52	08/12/2020 11:10	9,28	8	74,28	CHI
20201236368	GAMELEIRA DE GOIAS	AA12291825	ANAPOLIS UNIVERSITARIO S1	08/12/2020 01:52	08/12/2020 11:10	08/12/2020 01:52	08/12/2020 11:10	9,28	1	9,28	CHI
20201236374	NOVA CRIXAS	NA12391603	NOVA CRIXAS	08/12/2020 02:08	09/12/2020 19:55	08/12/2020 02:08	09/12/2020 19:55	41,78	41	1712,99	CHI
20201236377	GOIANESIA	1100001880	GOIANESIA S1	08/12/2020 02:11	08/12/2020 12:36	08/12/2020 02:11	08/12/2020 12:36	10,41	1	10,41	CHI
20201236378	PLANALTINA	10001370128	PLANALTINA	08/12/2020 02:11	08/12/2020 05:26	08/12/2020 02:11	08/12/2020 05:26	3,25	1	3,25	CHI
20201236380	EDEIA	EA12044042	EDEIA	08/12/2020 02:16	08/12/2020 02:59	08/12/2020 02:16	08/12/2020 02:59	0,71	3	2,14	CHI
202012179377	PILAR DE GOIAS	03400214	SANTA TEREZINHA	08/12/2020 02:34	08/12/2020 06:56	08/12/2020 02:34	08/12/2020 06:56	4,35	176	766,24	CHI
202012179377	ALTO HORIZONTE	03400214	SANTA TEREZINHA	08/12/2020 02:34	08/12/2020 06:56	08/12/2020 02:34	08/12/2020 06:56	4,35	12	52,24	CHI
202012179377	SANTA TEREZINHA DE GOIAS	03400214	SANTA TEREZINHA	08/12/2020 02:34	08/12/2020 06:56	08/12/2020 02:34	08/12/2020 06:56	4,35	65	282,98	CHI
202012179377	NOVA IGUACU DE GOIAS	03400214	SANTA TEREZINHA	08/12/2020 02:34	08/12/2020 06:56	08/12/2020 02:34	08/12/2020 06:56	4,35	843	3670,09	CHI
20201236408	CRIXAS	MZ12055628	MOZARLANDIA	08/12/2020 02:55	08/12/2020 07:51	08/12/2020 02:55	08/12/2020 07:51	4,92	26	127,91	CHI
20201236408	MOZARLANDIA	MZ12055628	MOZARLANDIA	08/12/2020 02:55	08/12/2020 07:51	08/12/2020 02:55	08/12/2020 07:51	4,92	40	196,78	CHI
20201236389	RIO VERDE	RV21029071	SANTA HELENA S1	08/12/2020 03:05	08/12/2020 05:24	08/12/2020 03:05	08/12/2020 05:24	2,31	2	4,61	CHI
20201236391	ALEXANIA	AX11200569	ALEXANIA	08/12/2020 03:08	08/12/2020 07:47	08/12/2020 03:08	08/12/2020 07:47	4,64	67	311,14	CHI
20201236394	CATALAO	1990078439	CATALAO S2	08/12/2020 03:20	08/12/2020 05:21	08/12/2020 03:20	08/12/2020 05:21	2,00	1	2,00	CHI
20201236395	CORUMBAIBA	CI12110154	VILA CORUMBA	08/12/2020 03:24	08/12/2020 16:57	08/12/2020 03:24	08/12/2020 16:57	13,55	27	365,75	CHI
20201236428	SAO LUIS DE MONTES BELOS	SL32145768	SAO LUIZ DOS MONTES BELOS	08/12/2020 03:27	08/12/2020 08:14	08/12/2020 03:27	08/12/2020 08:14	4,78	29	138,69	CHI
20201236397	FORMOSA	10027142734	ITUIQUIRA	08/12/2020 03:28	08/12/2020 14:50	08/12/2020 03:28	08/12/2020 14:50	11,36	1	11,36	CHI
20201237410	CROMINIA	CQ12000245	PONTALINA	08/12/2020 03:28	08/12/2020 10:53	08/12/2020 03:28	08/12/2020 10:53	7,40	9	66,64	CHI
20201236518	JATAI	JT12264349LD	JATAI S1	08/12/2020 03:30	08/12/2020 11:52	08/12/2020 03:30	08/12/2020 11:52	8,36	61	509,82	CHI
20201237406	ARAGARCAS	AG12140067	ARAGARCAS	08/12/2020 03:30	08/12/2020 10:49	08/12/2020 03:30	08/12/2020 10:49	7,30	52	379,70	CHI
20201238501	ARAGARCAS	AG11212930	ARAGARCAS	08/12/2020 03:30	08/12/2020 16:44	08/12/2020 03:30	08/12/2020 16:44	13,22	14	185,06	CHI
20201236583	SANCLERLANDIA	SL12019284	SAO LUIZ DOS MONTES BELOS	08/12/2020 03:32	08/12/2020 08:01	08/12/2020 03:32	08/12/2020 08:01	4,48	27	121,00	CHI
20201236583	SAO LUIS DE MONTES BELOS	SL12019284	SAO LUIZ DOS MONTES BELOS	08/12/2020 03:32	08/12/2020 08:01	08/12/2020 03:32	08/12/2020 08:01	4,48	58	259,94	CHI
20201236856	MUNDO NOVO DE GOIAS	NA12035650	NOVA CRIXAS	08/12/2020 03:34	08/12/2020 08:33	08/12/2020 03:34	08/12/2020 08:33	4,98	8	39,86	CHI
20201236856	NOVA CRIXAS	NA12035650	NOVA CRIXAS	08/12/2020 03:34	08/12/2020 08:33	08/12/2020 03:34	08/12/2020 08:33	4,98	24	119,57	CHI
20201236273	LUZIANIA	LZ12336006	VIANOPOLIS	08/12/2020 03:37	08/12/2020 08:24	08/12/2020 03:37	08/12/2020 08:24	4,78	109	520,66	CHI
20201237111	PETROLINA DE GOIAS	PG32086638	SAO FRANCISCO DE GOIAS	08/12/2020 04:01	08/12/2020 12:37	08/12/2020 04:01	08/12/2020 12:37	8,60	41	352,54	CHI
20201236584	FIRMINOPOLIS	FR12028946	FIRMINOPOLIS S1	08/12/2020 04:07	08/12/2020 07:53	08/12/2020 04:07	08/12/2020 07:53	3,76	21	79,03	CHI
20201236414	BOM JARDIM DE GOIAS	BM12334785	BOM JARDIM	08/12/2020 04:08	09/12/2020 04:50	08/12/2020 21:51	09/12/2020 00:36	2,76	9	24,84	CHI
20201236414	BOM JARDIM DE GOIAS	BM12201519LD	BOM JARDIM	08/12/2020 04:08	09/12/2020 04:50	08/12/2020 04:08	09/12/2020 04:50	24,71	40	988,36	CHI
20201236414	BOM JARDIM DE GOIAS	BM12201519LD	BOM JARDIM	08/12/2020 04:08	09/12/2020 04:50	08/12/2020 21:51	09/12/2020 04:50	6,99	11	76,90	CHI
20201237094	MINEIROS	MY12043897	PARQUE DAS EMAS	08/12/2020 04:18	09/12/2020 09:52	08/12/2020 04:18	08/12/2020 16:36	12,29	63	774,44	CHI
20201237094	MINEIROS	MY12043897	PARQUE DAS EMAS	08/12/2020 04:18	09/12/2020 09:52	08/12/2020 04:18	09/12/2020 09:52	29,56	61	1803,06	CHI
20201236879	SAO MIGUEL DO ARAGUAIA	SM12096096	SAO MIGUEL DO ARAGUAIA	08/12/2020 04:19	08/12/2020 09:04	08/12/2020 04:19	08/12/2020 09:04	4,75	13	61,71	CHI
20201237380	INDIARA	IY12391437	EDEIA	08/12/2020 04:24	08/12/2020 09:16	08/12/2020 04:24	08/12/2020 09:16	4,86	3	14,58	CHI
20201237155	GOIATUBA	GT12052882	GOIATUBA S1	08/12/2020 04:31	08/12/2020 08:51	08/12/2020 04:31	08/12/2020 08:51	4,32	29	125,21	CHI
20201236429	VARJAO	VJ12061520	GUAPO S2	08/12/2020 04:35	08/12/2020 08:05	08/12/2020 04:35	08/12/2020 08:05	3,49	6	20,92	CHI
20201236779	GOIANESIA	GE12115125	GOIANESIA S2	08/12/2020 04:40	08/12/2020 08:28	08/12/2020 04:40	08/12/2020 08:28	3,80	20	75,94	CHI
20201236229	CACU	CC12170574	CACHOEIRA ALTA	08/12/2020 04:41	08/12/2020 08:26	08/12/2020 04:41	08/12/2020 08:26	3,74	88	328,75	CHI
20201236229	APARECIDA DO RIO DOCE	CC12170574	CACHOEIRA ALTA	08/12/2020 04:41	08/12/2020 08:26	08/12/2020 04:41	08/12/2020 08:26	3,74	10	37,36	CHI

20201236433	ITAJA	IJ12370148	ITAJA S2	08/12/2020 04:43	08/12/2020 09:40	08/12/2020 04:43	08/12/2020 09:40	4,95	2	9,89	CHI
20201236742	LUZIANIA	OZ12186208	PIRES DO RIO S2	08/12/2020 04:45	08/12/2020 09:37	08/12/2020 04:45	08/12/2020 09:37	4,86	31	150,77	CHI
20201236437	MONTIVIDIU DO NORTE	MX12065532	PORANGATU	08/12/2020 04:50	08/12/2020 10:58	08/12/2020 04:50	08/12/2020 10:58	6,13	3	18,39	CHI
20201236438	DISTRITO FEDERAL	CW12383384	ITUIQUIRA	08/12/2020 04:50	08/12/2020 08:39	08/12/2020 04:50	08/12/2020 08:39	3,81	1	3,81	CHI
20201236438	CABECEIRAS	CW12383384	ITUIQUIRA	08/12/2020 04:50	08/12/2020 08:39	08/12/2020 04:50	08/12/2020 08:39	3,81	61	232,11	CHI
20201238066	PARAUNA	AI12008084	FIRMINOPOLIS S2	08/12/2020 05:00	08/12/2020 10:56	08/12/2020 05:00	08/12/2020 10:56	5,93	6	35,57	CHI
20201236494	SANTA HELENA DE GOIAS	TD12025737	RIO DOS BOIS	08/12/2020 05:02	08/12/2020 09:07	08/12/2020 05:02	08/12/2020 09:07	4,08	18	73,47	CHI
20201236494	ACREUNA	TD12025737	RIO DOS BOIS	08/12/2020 05:02	08/12/2020 09:07	08/12/2020 05:02	08/12/2020 09:07	4,08	26	106,13	CHI
20201236494	TURVELANDIA	TD12025737	RIO DOS BOIS	08/12/2020 05:02	08/12/2020 09:07	08/12/2020 05:02	08/12/2020 09:07	4,08	65	265,33	CHI
20201237250	NEROPOLIS	NR12317364	NEROPOLIS S2	08/12/2020 05:06	08/12/2020 09:26	08/12/2020 05:06	08/12/2020 09:26	4,32	2	8,64	CHI
20201237759	BURITINOPOLIS	MB12361385	IACIARA S2	08/12/2020 05:06	08/12/2020 11:26	08/12/2020 05:06	08/12/2020 11:26	6,32	20	126,39	CHI
20201237911	INACIOLANDIA	CD12000137	CACHOEIRA DOURADA	08/12/2020 05:06	08/12/2020 18:17	08/12/2020 05:06	08/12/2020 18:17	13,18	15	197,63	CHI
20201236811	PARANAIGUARA	PC12047562	QUIRINOPOLIS	08/12/2020 05:09	08/12/2020 09:33	08/12/2020 05:09	08/12/2020 09:33	4,39	21	92,14	CHI
20201236449	APARECIDA DE GOIANIA	Z00602240	INDEPENDENCIA S2	08/12/2020 05:10	08/12/2020 08:23	08/12/2020 05:10	08/12/2020 08:23	3,21	1	3,21	CHI
20201236496	QUIRINOPOLIS	QI12279582	QUIRINOPOLIS	08/12/2020 05:12	08/12/2020 08:58	08/12/2020 05:12	08/12/2020 08:58	3,75	14	52,54	CHI
20201236792	BARRO ALTO	BA12068485	BARRO ALTO	08/12/2020 05:12	08/12/2020 13:00	08/12/2020 05:12	08/12/2020 13:00	7,79	1	7,79	CHI
20201236792	SANTA RITA DO NOVO DESTINO	BA12068485	BARRO ALTO	08/12/2020 05:12	08/12/2020 13:00	08/12/2020 05:12	08/12/2020 13:00	7,79	32	249,29	CHI
20201236456	ARUANA	MP12274498	MOZARLANDIA	08/12/2020 05:13	08/12/2020 08:47	08/12/2020 05:13	08/12/2020 08:47	3,55	5	17,76	CHI
20201236456	MATRINCHA	MP12274498	MOZARLANDIA	08/12/2020 05:13	08/12/2020 08:47	08/12/2020 05:13	08/12/2020 08:47	3,55	3	10,65	CHI
20201237105	FIRMINOPOLIS	FR12061354	FIRMINOPOLIS S1	08/12/2020 05:13	08/12/2020 09:20	08/12/2020 05:13	08/12/2020 09:20	4,11	20	82,26	CHI
20201237084	JUSSARA	JR12008743	BRITANIA	08/12/2020 05:15	08/12/2020 09:12	08/12/2020 05:15	08/12/2020 09:12	3,94	38	149,76	CHI
20201236523	MOSSAMEDES	MD12006197	FIRMINOPOLIS S2	08/12/2020 05:20	08/12/2020 13:11	08/12/2020 05:20	08/12/2020 08:35	3,24	16	51,81	CHI
20201236523	MOSSAMEDES	MD12006197	FIRMINOPOLIS S2	08/12/2020 05:20	08/12/2020 13:11	08/12/2020 05:20	08/12/2020 11:02	5,69	7	39,82	CHI
20201236523	MOSSAMEDES	MD12006197	FIRMINOPOLIS S2	08/12/2020 05:20	08/12/2020 13:11	08/12/2020 05:20	08/12/2020 11:02	0,70	16	11,20	CHI
20201236523	MOSSAMEDES	MD12006197	FIRMINOPOLIS S2	08/12/2020 05:20	08/12/2020 13:11	08/12/2020 05:20	08/12/2020 13:11	7,84	1	7,84	CHI
20201236702	QUIRINOPOLIS	QI12101348	QUIRINOPOLIS	08/12/2020 05:22	08/12/2020 08:30	08/12/2020 05:22	08/12/2020 08:30	3,12	54	168,71	CHI
20201238099	ALVORADA DO NORTE	AQ12184658	FLORES DE GOIAS	08/12/2020 05:22	09/12/2020 09:58	08/12/2020 05:22	09/12/2020 09:58	28,59	18	514,65	CHI
20201236543	CASTELANDIA	QI12050368	QUIRINOPOLIS	08/12/2020 05:23	08/12/2020 07:37	08/12/2020 05:23	08/12/2020 07:37	2,22	1	2,22	CHI
20201236543	QUIRINOPOLIS	QI12050368	QUIRINOPOLIS	08/12/2020 05:23	08/12/2020 07:37	08/12/2020 05:23	08/12/2020 07:37	2,22	32	70,94	CHI
20201236548	PORANGATU	PO12064911	NOVO PLANALTO	08/12/2020 05:24	08/12/2020 09:21	08/12/2020 05:24	08/12/2020 09:21	3,94	135	531,90	CHI
20201236466	PORANGATU	PO21137644	PORANGATU	08/12/2020 05:26	08/12/2020 09:11	08/12/2020 05:26	08/12/2020 09:11	3,74	2	7,49	CHI
20201236467	CACHOEIRA ALTA	I090009176	CACHOEIRA ALTA	08/12/2020 05:27	08/12/2020 10:49	08/12/2020 05:27	08/12/2020 10:49	5,36	1	5,36	CHI
20201236784	PARANAIGUARA	PC12000018	CACHOEIRA ALTA	08/12/2020 05:27	08/12/2020 09:04	08/12/2020 05:27	08/12/2020 09:04	3,60	29	104,50	CHI
20201236784	CACHOEIRA ALTA	PC12000018	CACHOEIRA ALTA	08/12/2020 05:27	08/12/2020 09:04	08/12/2020 05:27	08/12/2020 09:04	3,60	8	28,83	CHI
20201236784	SAO SIMAO	PC12000018	CACHOEIRA ALTA	08/12/2020 05:27	08/12/2020 09:04	08/12/2020 05:27	08/12/2020 09:04	3,60	5	18,02	CHI
20201236471	CACU	CC11365976	CACHOEIRA ALTA	08/12/2020 05:29	08/12/2020 09:31	08/12/2020 05:29	08/12/2020 09:31	4,02	11	44,21	CHI
20201236475	IPAMERI	IP12107653	IPAMERI	08/12/2020 05:31	08/12/2020 08:06	08/12/2020 05:31	08/12/2020 08:06	2,58	91	234,48	CHI
20201236475	CALDAS NOVAS	IP12107653	IPAMERI	08/12/2020 05:31	08/12/2020 08:06	08/12/2020 05:31	08/12/2020 08:06	2,58	11	28,34	CHI
20201236475	CORUMBAIBA	IP12107653	IPAMERI	08/12/2020 05:31	08/12/2020 08:06	08/12/2020 05:31	08/12/2020 08:06	2,58	3	7,73	CHI
20201236757	AMORINOPOLIS	AM12193439	IPORA	08/12/2020 05:31	08/12/2020 15:07	08/12/2020 05:31	08/12/2020 15:07	9,60	14	134,40	CHI
20201236478	CALDAS NOVAS	CN12082137	SERRA DE CALDAS	08/12/2020 05:33	08/12/2020 07:16	08/12/2020 05:33	08/12/2020 07:16	1,71	1	1,71	CHI
20201236479	ANAPOLIS	AN12262499	ANAPOLIS UNIVERSITARIO S1	08/12/2020 05:33	08/12/2020 08:30	08/12/2020 05:33	08/12/2020 08:30	2,94	11	32,30	CHI
20201236560	PIRACANJUBA	PJ12204565RE	PIRACANJUBA	08/12/2020 05:33	08/12/2020 08:43	08/12/2020 05:33	08/12/2020 08:43	3,15	290	913,58	CHI
20201236560	PROFESSOR JAMIL SAFADY	PJ12204565RE	PIRACANJUBA	08/12/2020 05:33	08/12/2020 08:43	08/12/2020 05:33	08/12/2020 08:43	3,15	13	40,95	CHI
20201236560	HIDROLANDIA	PJ12204565RE	PIRACANJUBA	08/12/2020 05:33	08/12/2020 08:43	08/12/2020 05:33	08/12/2020 08:43	3,15	15	47,25	CHI
20201236502	QUIRINOPOLIS	QI12303193	RIO DOS BOIS	08/12/2020 05:35	08/12/2020 07:37	08/12/2020 05:35	08/12/2020 07:37	2,03	4	8,11	CHI
20201236604	MINACU	IH12171869	MINACU	08/12/2020 05:35	08/12/2020 07:12	08/12/2020 05:35	08/12/2020 07:12	1,61	77	123,76	CHI
20201237658	ITARUMA	IM12402357	CACHOEIRA ALTA	08/12/2020 05:35	08/12/2020 16:29	08/12/2020 05:35	08/12/2020 16:29	10,89	6	65,33	CHI
20201237669	PIRES DO RIO	PR12064876RE	PIRES DO RIO S1	08/12/2020 05:38	08/12/2020 09:21	08/12/2020 05:38	08/12/2020 09:21	3,71	36	133,52	CHI
20201236503	SANTA HELENA DE GOIAS	SH12271532	IPEGUARI	08/12/2020 05:41	08/12/2020 06:53	08/12/2020 05:41	08/12/2020 06:53	1,19	23	27,42	CHI
20201236503	RIO VERDE	SH12271532	IPEGUARI	08/12/2020 05:41	08/12/2020 06:53	08/12/2020 05:41	08/12/2020 06:53	1,19	1	1,19	CHI

20201236520	CAMPO ALEGRE DE GOIAS	CM12063944	CAMPO ALEGRE DE GOIAS	08/12/2020 05:42	08/12/2020 08:26	08/12/2020 05:42	08/12/2020 08:26	2,73	27	73,65	CHI
20201236520	IPAMERI	CM12063944	CAMPO ALEGRE DE GOIAS	08/12/2020 05:42	08/12/2020 08:26	08/12/2020 05:42	08/12/2020 08:26	2,73	4	10,91	CHI
20201236507	CACU	CC12033598	CACHOEIRA ALTA	08/12/2020 05:43	08/12/2020 08:04	08/12/2020 05:43	08/12/2020 08:04	2,35	4	9,38	CHI
20201236508	CAMPOS VERDES	VD12065501	SANTA TEREZINHA	08/12/2020 05:43	08/12/2020 17:04	08/12/2020 05:43	08/12/2020 17:04	11,34	2	22,68	CHI
20201236516	GOIATUBA	GT12296905	GOIATUBA S2	08/12/2020 05:43	08/12/2020 09:36	08/12/2020 05:43	08/12/2020 09:36	3,88	7	27,17	CHI
20201236509	CACU	CC12000096	CACHOEIRA ALTA	08/12/2020 05:44	08/12/2020 08:42	08/12/2020 05:44	08/12/2020 08:42	2,96	5	14,80	CHI
20201236511	BURITI ALEGRE	BG12257082	ALTO BURITI	08/12/2020 05:44	08/12/2020 13:23	08/12/2020 05:44	08/12/2020 13:23	7,64	24	183,33	CHI
20201236511	MORRINHOS	BG12257082	ALTO BURITI	08/12/2020 05:44	08/12/2020 13:23	08/12/2020 05:44	08/12/2020 13:23	7,64	5	38,19	CHI
20201237179	CORUMBA DE GOIAS	ZN12261437	AGUAS LINDAS DE GOIAS S2	08/12/2020 05:45	08/12/2020 19:24	08/12/2020 05:45	08/12/2020 11:59	6,23	3	18,69	CHI
20201237179	COCALZINHO DE GOIAS	ZN12261437	AGUAS LINDAS DE GOIAS S2	08/12/2020 05:45	08/12/2020 19:24	08/12/2020 05:45	08/12/2020 11:59	6,23	4	24,92	CHI
20201237179	CORUMBA DE GOIAS	ZN12261437	AGUAS LINDAS DE GOIAS S2	08/12/2020 05:45	08/12/2020 19:24	08/12/2020 05:45	08/12/2020 19:24	13,64	2	27,28	CHI
20201237179	COCALZINHO DE GOIAS	ZN12261437	AGUAS LINDAS DE GOIAS S2	08/12/2020 05:45	08/12/2020 19:24	08/12/2020 05:45	08/12/2020 19:24	13,64	2	27,28	CHI
20201237179	COCALZINHO DE GOIAS	ZN12261437	AGUAS LINDAS DE GOIAS S2	08/12/2020 05:45	08/12/2020 19:24	08/12/2020 17:29	08/12/2020 19:24	1,91	4	7,63	CHI
20201237179	CORUMBA DE GOIAS	ZN12261437	AGUAS LINDAS DE GOIAS S2	08/12/2020 05:45	08/12/2020 19:24	08/12/2020 17:29	08/12/2020 19:24	1,91	3	5,72	CHI
20201236829	DIORAMA	JP10396034	IPORA	08/12/2020 05:46	08/12/2020 10:35	08/12/2020 05:46	08/12/2020 10:35	4,82	12	57,80	CHI
20201236829	JAUPACI	JP10396034	IPORA	08/12/2020 05:46	08/12/2020 10:35	08/12/2020 05:46	08/12/2020 10:35	4,82	64	308,25	CHI
20201237116	JAUPACI	JP21021461	IPORA	08/12/2020 05:46	08/12/2020 14:48	08/12/2020 05:46	08/12/2020 14:48	9,02	1	9,02	CHI
20201236526	CACHOEIRA ALTA	CA12305852	CACHOEIRA ALTA	08/12/2020 05:49	08/12/2020 11:09	08/12/2020 05:49	08/12/2020 11:09	5,32	2	10,65	CHI
20201236526	CACU	CA12305852	CACHOEIRA ALTA	08/12/2020 05:49	08/12/2020 11:09	08/12/2020 05:49	08/12/2020 11:09	5,32	1	5,32	CHI
20201236527	VALPARAISO DE GOIAS	VA12183504	PACAEMBU S1	08/12/2020 05:49	08/12/2020 09:15	08/12/2020 05:49	08/12/2020 09:15	3,42	86	294,19	CHI
20201236744	CAIAPONIA	CP12204876	CAIAPONIA	08/12/2020 05:49	09/12/2020 09:43	08/12/2020 05:49	09/12/2020 09:43	27,89	10	278,93	CHI
20201236528	MONTES CLAROS DE GOIAS	ME12260033	IPORA	08/12/2020 05:50	08/12/2020 14:47	08/12/2020 05:50	08/12/2020 14:47	8,94	3	26,83	CHI
20201236530	GOIANESIA	550069719	GOIANESIA S2	08/12/2020 05:51	08/12/2020 13:27	08/12/2020 05:51	08/12/2020 13:27	7,60	1	7,60	CHI
20201237063	QUIRINOPOLIS	QI32255692	QUIRINOPOLIS	08/12/2020 05:51	08/12/2020 09:20	08/12/2020 05:51	08/12/2020 09:20	3,47	18	62,45	CHI
20201236573	SAO MIGUEL DO ARAGUAIA	SM12220856	SAO MIGUEL DO ARAGUAIA	08/12/2020 05:52	08/12/2020 13:10	08/12/2020 05:52	08/12/2020 13:10	7,29	11	80,22	CHI
20201236794	ITUMBIARA	IT12033777	CACHOEIRA DOURADA	08/12/2020 05:52	08/12/2020 11:29	08/12/2020 05:52	08/12/2020 11:29	5,62	13	73,01	CHI
20201237003	GOUVELANDIA	GB11018074	QUIRINOPOLIS	08/12/2020 05:53	08/12/2020 09:55	08/12/2020 05:53	08/12/2020 09:55	4,03	108	435,00	CHI
20201236541	GOIANIA	10592404	CARAJAS S1	08/12/2020 05:54	08/12/2020 09:09	08/12/2020 05:54	08/12/2020 09:09	3,25	1	3,25	CHI
20201236542	GOIANIA	GN12002513	CAMPINAS S2	08/12/2020 05:54	08/12/2020 09:25	08/12/2020 05:54	08/12/2020 09:25	3,51	323	1134,18	CHI
20201236683	FLORES DE GOIAS	FB12085509	FLORES DE GOIAS	08/12/2020 05:54	08/12/2020 17:26	08/12/2020 05:54	08/12/2020 16:41	10,78	3	32,34	CHI
20201236683	FLORES DE GOIAS	FB12085509	FLORES DE GOIAS	08/12/2020 05:54	08/12/2020 17:26	08/12/2020 05:54	08/12/2020 17:26	11,53	3	34,59	CHI
20201236683	FLORES DE GOIAS	FB12344172	FLORES DE GOIAS	08/12/2020 05:54	08/12/2020 17:26	08/12/2020 10:11	08/12/2020 17:26	7,25	1	7,25	CHI
20201237123	CRIXAS	CX12226949	SANTA TEREZINHA	08/12/2020 05:55	08/12/2020 14:12	08/12/2020 05:55	08/12/2020 14:12	8,28	11	91,03	CHI
20201236553	BOM JESUS DE GOIAS	BJ12000149RE	BOM JESUS DE GOIAS	08/12/2020 05:57	08/12/2020 10:01	08/12/2020 05:57	08/12/2020 10:01	4,06	18	73,10	CHI
20201236554	ALTO HORIZONTE	AJ21202019	MARA ROSA	08/12/2020 05:57	08/12/2020 15:06	08/12/2020 05:57	08/12/2020 15:06	9,14	1	9,14	CHI
20201237056	INDIARA	IY12299110LD	EDEIA	08/12/2020 05:58	08/12/2020 09:32	08/12/2020 05:58	08/12/2020 09:32	3,56	39	138,94	CHI
20201236565	PARANAIGUARA	PC12306051	QUIRINOPOLIS	08/12/2020 06:00	09/12/2020 12:42	08/12/2020 06:00	09/12/2020 12:42	30,71	1	30,71	CHI
20201236567	GOIATUBA	JV21047702	GOIATUBA S1	08/12/2020 06:00	08/12/2020 14:56	08/12/2020 06:00	08/12/2020 14:56	8,93	1	8,93	CHI
20201236569	CROMINIA	CQ21000225	PONTALINA	08/12/2020 06:00	08/12/2020 13:45	08/12/2020 06:00	08/12/2020 13:45	7,74	2	15,48	CHI
20201236574	LUZIANIA	LZ12290851	MARAJOARA	08/12/2020 06:01	08/12/2020 11:57	08/12/2020 06:01	08/12/2020 11:57	5,92	25	148,06	CHI
20201236601	MONTIVIDIU DO NORTE	MX12391987	PORANGATU	08/12/2020 06:01	08/12/2020 18:59	08/12/2020 06:01	08/12/2020 18:59	12,97	18	233,37	CHI
20201237171	JESUPOLIS	JE12377422	SAO FRANCISCO DE GOIAS	08/12/2020 06:01	08/12/2020 14:24	08/12/2020 06:01	08/12/2020 14:24	8,38	6	50,27	CHI
20201236578	ITUMBIARA	IT11263734	CACHOEIRA DOURADA	08/12/2020 06:02	08/12/2020 10:35	08/12/2020 06:02	08/12/2020 10:35	4,54	1	4,54	CHI
20201236774	CACHOEIRA ALTA	CA12071605	CACHOEIRA ALTA	08/12/2020 06:02	08/12/2020 09:16	08/12/2020 06:02	08/12/2020 09:16	3,22	34	109,64	CHI
20201236785	FORMOSA	FA12383272	ITIQUEIRA	08/12/2020 06:02	08/12/2020 10:06	08/12/2020 06:02	08/12/2020 10:06	4,05	39	157,97	CHI
20201236789	BURITINOPOLIS	PS12189370	IACIARA S2	08/12/2020 06:03	08/12/2020 18:01	08/12/2020 06:03	08/12/2020 18:01	11,96	2	23,92	CHI
20201236789	MAMBAI	PS12189370	IACIARA S2	08/12/2020 06:03	08/12/2020 18:01	08/12/2020 06:03	08/12/2020 18:01	11,96	28	334,89	CHI
20201236789	POSSE	PS12189370	IACIARA S2	08/12/2020 06:03	08/12/2020 18:01	08/12/2020 06:03	08/12/2020 18:01	11,96	4	47,84	CHI
20201236840	PETROLINA DE GOIAS	PG12031546	PETROLINA	08/12/2020 06:03	08/12/2020 10:16	08/12/2020 06:03	08/12/2020 10:16	4,20	24	100,81	CHI
20201235361	INACIOLANDIA	ID12271589	CACHOEIRA DOURADA	08/12/2020 06:04	09/12/2020 11:15	08/12/2020 06:21	09/12/2020 08:21	26,01	4	104,03	CHI
20201235361	INACIOLANDIA	ID12271589	CACHOEIRA DOURADA	08/12/2020 06:04	09/12/2020 11:15	08/12/2020 06:21	09/12/2020 09:49	27,47	11	302,22	CHI

20201235361	INACIOLANDIA	ID12271589	CACHOEIRA DOURADA	08/12/2020 06:04	09/12/2020 11:15	08/12/2020 06:21	09/12/2020 11:15	28,91	1	28,91	CHI
20201236585	CATALAO	CT12044351	CATALAO S2	08/12/2020 06:04	08/12/2020 07:33	08/12/2020 06:04	08/12/2020 07:33	1,47	21	30,96	CHI
20201236588	MONTES CLAROS DE GOIAS	ME12038971	IPORA	08/12/2020 06:05	08/12/2020 12:09	08/12/2020 06:05	08/12/2020 12:09	6,05	22	133,11	CHI
20201236590	LUZIANIA	SV12249236	VIANOPOLIS	08/12/2020 06:06	08/12/2020 09:28	08/12/2020 06:06	08/12/2020 09:28	3,36	2	6,72	CHI
20201236622	ARENOPOLIS	AY12000021	ARENOPOLIS	08/12/2020 06:06	08/12/2020 10:30	08/12/2020 06:06	08/12/2020 10:30	4,39	19	83,46	CHI
20201236596	PORANGATU	PO21230421	PORANGATU	08/12/2020 06:08	08/12/2020 08:26	08/12/2020 06:08	08/12/2020 08:26	2,29	1	2,29	CHI
20201238522	POSSE	PS12257684	IACIARA S2	08/12/2020 06:08	08/12/2020 23:08	08/12/2020 06:08	08/12/2020 23:08	16,99	5	84,94	CHI
20201236600	GOIAS	GS12068548	MATRINCHA	08/12/2020 06:09	08/12/2020 08:26	08/12/2020 06:09	08/12/2020 08:26	2,28	42	95,76	CHI
20201236602	CALDAS NOVAS	CN12246589	SERRA DE CALDAS	08/12/2020 06:09	08/12/2020 08:54	08/12/2020 06:09	08/12/2020 08:54	2,74	56	153,60	CHI
20201237175	PALESTINA DE GOIAS	PY12023466	PALESTINA	08/12/2020 06:10	08/12/2020 15:11	08/12/2020 06:10	08/12/2020 15:11	9,01	4	36,05	CHI
20201236985	EDEIA	EA12086934	EDEIA	08/12/2020 06:12	08/12/2020 09:39	08/12/2020 06:12	08/12/2020 09:39	3,44	4	13,74	CHI
20201237682	RIO VERDE	RV18301218TS	SANTA HELENA S1	08/12/2020 06:12	08/12/2020 12:23	08/12/2020 06:12	08/12/2020 12:23	6,17	19	117,21	CHI
20201237682	QUIRINOPOLIS	RV18301218TS	SANTA HELENA S1	08/12/2020 06:12	08/12/2020 12:23	08/12/2020 06:12	08/12/2020 12:23	6,17	39	240,60	CHI
20201236680	INACIOLANDIA	ID12128250	QUIRINOPOLIS	08/12/2020 06:13	08/12/2020 19:42	08/12/2020 06:13	08/12/2020 19:42	13,48	9	121,30	CHI
20201236680	BOM JESUS DE GOIAS	ID12128250	QUIRINOPOLIS	08/12/2020 06:13	08/12/2020 19:42	08/12/2020 06:13	08/12/2020 19:42	13,48	72	970,38	CHI
20201236971	SAO JOAO D ALIANCA	TL12302766	SAO JOAO D ALIANCA	08/12/2020 06:13	08/12/2020 09:54	08/12/2020 06:13	08/12/2020 09:54	3,68	1	3,68	CHI
20201236971	AGUA FRIA DE GOIAS	TL12302766	SAO JOAO D ALIANCA	08/12/2020 06:13	08/12/2020 09:54	08/12/2020 06:13	08/12/2020 09:54	3,68	79	290,35	CHI
20201237098	ARAGUAPAZ	RB12022187	ITAPURANGA	08/12/2020 06:13	08/12/2020 09:01	08/12/2020 06:13	08/12/2020 09:01	2,79	1	2,79	CHI
20201237098	MORRO AGUDO DE GOIAS	RB12022187	ITAPURANGA	08/12/2020 06:13	08/12/2020 09:01	08/12/2020 06:13	08/12/2020 09:01	2,79	1	2,79	CHI
20201237098	RUBIATABA	RB12022187	ITAPURANGA	08/12/2020 06:13	08/12/2020 09:01	08/12/2020 06:13	08/12/2020 09:01	2,79	9	25,12	CHI
20201236625	CACU	CC12202627	CACHOEIRA ALTA	08/12/2020 06:14	08/12/2020 14:24	08/12/2020 06:14	08/12/2020 14:24	8,16	2	16,32	CHI
20201236632	CRISTALINA	KR21171564	CRISTALINA S2	08/12/2020 06:16	08/12/2020 10:37	08/12/2020 06:16	08/12/2020 10:37	4,34	2	8,69	CHI
20201236641	PORANGATU	840136500	PORANGATU	08/12/2020 06:17	08/12/2020 09:39	08/12/2020 06:17	08/12/2020 09:39	3,35	1	3,35	CHI
20201236644	BONOPOLIS	BX12013030	SAO MIGUEL DO ARAGUAIA	08/12/2020 06:18	08/12/2020 09:39	08/12/2020 06:18	08/12/2020 09:39	3,34	5	16,71	CHI
20201236805	DOVERLANDIA	CP12119577	CAIAPONIA	08/12/2020 06:18	09/12/2020 00:45	08/12/2020 06:18	09/12/2020 00:45	18,45	7	129,14	CHI
20201236805	CAIAPONIA	CP12119577	CAIAPONIA	08/12/2020 06:18	09/12/2020 00:45	08/12/2020 06:18	09/12/2020 00:45	18,45	67	1236,08	CHI
20201236648	BOM JESUS DE GOIAS	BJ12000041RE	BOM JESUS DE GOIAS	08/12/2020 06:19	08/12/2020 12:37	08/12/2020 06:19	08/12/2020 12:37	6,29	45	283,25	CHI
20201236648	ITUMBIARA	BJ12000041RE	BOM JESUS DE GOIAS	08/12/2020 06:19	08/12/2020 12:37	08/12/2020 06:19	08/12/2020 12:37	6,29	2	12,59	CHI
20201236649	GOIATUBA	GT12273783	GOIATUBA S2	08/12/2020 06:19	08/12/2020 09:23	08/12/2020 06:19	08/12/2020 09:23	3,06	40	122,43	CHI
20201236650	QUIRINOPOLIS	QI21303041	QUIRINOPOLIS	08/12/2020 06:19	08/12/2020 13:10	08/12/2020 06:19	08/12/2020 13:10	6,83	1	6,83	CHI
20201236660	CRIXAS	CX12055157	SERRA DO OURO	08/12/2020 06:23	08/12/2020 08:48	08/12/2020 06:23	08/12/2020 08:48	2,41	8	19,25	CHI
20201237412	RIO VERDE	RV12029070	SANTA HELENA S1	08/12/2020 06:23	08/12/2020 10:23	08/12/2020 06:23	08/12/2020 10:23	4,00	4	15,98	CHI
20201236664	MINACU	IH12230363	MINACU	08/12/2020 06:24	08/12/2020 23:42	08/12/2020 06:24	08/12/2020 23:42	17,30	6	103,79	CHI
20201238477	JATAI	JT12211164	JATAI S2	08/12/2020 06:24	08/12/2020 14:40	08/12/2020 06:24	08/12/2020 14:40	8,26	10	82,56	CHI
20201236673	MONTES CLAROS DE GOIAS	ME21140034	IPORA	08/12/2020 06:25	08/12/2020 15:05	08/12/2020 06:25	08/12/2020 15:05	8,65	1	8,65	CHI
20201236675	JATAI	JT21365054	JATAI S3	08/12/2020 06:25	08/12/2020 18:43	08/12/2020 06:25	08/12/2020 18:43	12,29	1	12,29	CHI
20201238893	BOM JARDIM DE GOIAS	BM12390150	BOM JARDIM	08/12/2020 06:25	08/12/2020 20:05	08/12/2020 06:25	08/12/2020 20:05	13,65	9	122,88	CHI
20201238893	BALIZA	BM12390150	BOM JARDIM	08/12/2020 06:25	08/12/2020 20:05	08/12/2020 06:25	08/12/2020 20:05	13,65	50	682,67	CHI
20201236679	ALTO HORIZONTE	AJ21143575	MARA ROSA	08/12/2020 06:26	08/12/2020 08:12	08/12/2020 06:26	08/12/2020 08:12	1,76	1	1,76	CHI
20201237694	PIRACANJUBA	PJ12212176RE	PIRACANJUBA	08/12/2020 06:26	08/12/2020 12:14	08/12/2020 06:26	08/12/2020 12:14	5,80	14	81,17	CHI
20201237694	SANTA CRUZ DE GOIAS	PJ12212176RE	PIRACANJUBA	08/12/2020 06:26	08/12/2020 12:14	08/12/2020 06:26	08/12/2020 12:14	5,80	75	434,85	CHI
20201237694	CRISTIANOPOLIS	PJ12212176RE	PIRACANJUBA	08/12/2020 06:26	08/12/2020 12:14	08/12/2020 06:26	08/12/2020 12:14	5,80	4	23,19	CHI
20201236686	PLANALTINA	PI12302898	PLANALTINA	08/12/2020 06:27	08/12/2020 12:00	08/12/2020 06:27	08/12/2020 12:00	5,55	70	388,23	CHI
20201238101	IACIARA	AQ12257608	FLORES DE GOIAS	08/12/2020 06:27	09/12/2020 11:32	08/12/2020 06:27	09/12/2020 11:32	29,07	4	116,29	CHI
20201238101	POSSE	AQ12257608	FLORES DE GOIAS	08/12/2020 06:27	09/12/2020 11:32	08/12/2020 06:27	09/12/2020 11:32	29,07	2	58,15	CHI
20201238101	ALVORADA DO NORTE	AQ12257608	FLORES DE GOIAS	08/12/2020 06:27	09/12/2020 11:32	08/12/2020 06:27	09/12/2020 11:32	29,07	10	290,73	CHI
20201239000	PARAUNA	PU12307075	PARAUNA	08/12/2020 06:28	08/12/2020 16:56	08/12/2020 06:28	08/12/2020 16:56	10,46	5	52,30	CHI
20201237035	GOIAS	GS12091169	MATRINCHA	08/12/2020 06:29	08/12/2020 10:33	08/12/2020 06:29	08/12/2020 10:33	4,05	9	36,47	CHI
20201236707	PORANGATU	PO12192280	PORANGATU	08/12/2020 06:30	09/12/2020 11:30	08/12/2020 06:30	08/12/2020 16:32	10,03	2	20,06	CHI
20201236707	PORANGATU	PO12187968LD	PORANGATU	08/12/2020 06:30	09/12/2020 11:30	08/12/2020 06:30	09/12/2020 11:30	29,00	3	87,00	CHI
20201236793	PARAUNA	PU12194221	ACREUNA	08/12/2020 06:30	08/12/2020 16:57	08/12/2020 06:30	08/12/2020 16:57	10,44	35	365,39	CHI

20201236713	ITUMBIARA	CD12097345RE	BOM JESUS DE GOIAS	08/12/2020 06:31	08/12/2020 11:26	08/12/2020 06:31	08/12/2020 11:26	4,91	8	39,27	CHI
20201237925	CACHOEIRA DE GOIAS	CG12206059	FIRMINOPOLIS S2	08/12/2020 06:31	08/12/2020 12:23	08/12/2020 06:31	08/12/2020 12:23	5,86	25	146,60	CHI
20201239074	JATAI	JT12219503	JATAI S3	08/12/2020 06:31	09/12/2020 07:56	08/12/2020 06:31	09/12/2020 07:56	25,41	4	101,64	CHI
20201236717	BRAZABRANTES	380000143	NEROPOLIS S1	08/12/2020 06:33	08/12/2020 10:12	08/12/2020 06:33	08/12/2020 10:12	3,65	1	3,65	CHI
20201236745	RIO VERDE	RV12098595	RIO VERDE S1	08/12/2020 06:33	08/12/2020 08:52	08/12/2020 06:33	08/12/2020 08:52	2,31	17	39,20	CHI
20201236722	ALOANDIA	AD21129246	GOIATUBA S1	08/12/2020 06:35	08/12/2020 15:00	08/12/2020 06:35	08/12/2020 15:00	8,42	1	8,42	CHI
20201236731	EDEIA	CL12230806RE	RIO DOS BOIS	08/12/2020 06:36	09/12/2020 17:41	08/12/2020 06:36	09/12/2020 17:41	35,09	2	70,18	CHI
20201236731	PORTEIRAO	CL12230806RE	RIO DOS BOIS	08/12/2020 06:36	09/12/2020 17:41	09/12/2020 13:22	09/12/2020 17:41	4,33	4	17,33	CHI
20201236731	VICENTINOPOLIS	CL12230806RE	RIO DOS BOIS	08/12/2020 06:36	09/12/2020 17:41	09/12/2020 13:22	09/12/2020 17:41	4,33	4	17,33	CHI
20201237587	JATAI	RV12104996	JATAI S2	08/12/2020 06:36	08/12/2020 13:50	08/12/2020 06:36	08/12/2020 13:50	7,24	13	94,07	CHI
20201237587	RIO VERDE	RV12104996	JATAI S2	08/12/2020 06:36	08/12/2020 13:50	08/12/2020 06:36	08/12/2020 13:50	7,24	7	50,65	CHI
20201237213	DIORAMA	DI12065689	IPORA	08/12/2020 06:37	08/12/2020 09:17	08/12/2020 06:37	08/12/2020 09:17	2,67	14	37,31	CHI
20201237809	GOUVELANDIA	GB12303132	QUIRINOPOLIS	08/12/2020 06:37	08/12/2020 11:49	08/12/2020 06:37	08/12/2020 11:49	5,19	53	274,98	CHI
20201236741	PIRENOPOLIS	PV21185587	CORUMBA	08/12/2020 06:38	08/12/2020 15:52	08/12/2020 06:38	08/12/2020 15:52	9,23	2	18,46	CHI
20201236815	JUSSARA	JR12362437	BRITANIA	08/12/2020 06:39	08/12/2020 13:10	08/12/2020 06:39	08/12/2020 13:10	6,53	7	45,68	CHI
20201236815	FAZENDA NOVA	JR12362437	BRITANIA	08/12/2020 06:39	08/12/2020 13:10	08/12/2020 06:39	08/12/2020 13:10	6,53	3	19,58	CHI
20201236752	SANTA HELENA DE GOIAS	RV21023757	RIO DOS BOIS	08/12/2020 06:40	08/12/2020 10:40	08/12/2020 06:40	08/12/2020 10:40	3,99	3	11,96	CHI
20201236753	JANDAIA	PU12357332	PARAUNA	08/12/2020 06:40	08/12/2020 14:27	08/12/2020 06:40	08/12/2020 14:27	7,78	3	23,34	CHI
20201236753	PARAUNA	PU12357332	PARAUNA	08/12/2020 06:40	08/12/2020 14:27	08/12/2020 06:40	08/12/2020 14:27	7,78	30	233,40	CHI
20201236798	FORMOSA	FB12106993	FLORES DE GOIAS	08/12/2020 06:40	08/12/2020 09:32	08/12/2020 06:40	08/12/2020 09:32	2,86	134	383,39	CHI
20201236798	FORMOSO	FB12106993	FLORES DE GOIAS	08/12/2020 06:40	08/12/2020 09:32	08/12/2020 06:40	08/12/2020 09:32	2,86	1	2,86	CHI
20201236798	SAO JOAO D ALIANCA	FB12106993	FLORES DE GOIAS	08/12/2020 06:40	08/12/2020 09:32	08/12/2020 06:40	08/12/2020 09:32	2,86	4	11,44	CHI
20201236798	FLORES DE GOIAS	FB12106993	FLORES DE GOIAS	08/12/2020 06:40	08/12/2020 09:32	08/12/2020 06:40	08/12/2020 09:32	2,86	11	31,47	CHI
20201236754	GOIATUBA	BJ12392121	BOM JESUS DE GOIAS	08/12/2020 06:41	08/12/2020 10:39	08/12/2020 06:41	08/12/2020 10:39	3,96	15	59,44	CHI
20201236762	JARAGUA	JA21232658	ITABERAI S1	08/12/2020 06:42	08/12/2020 15:56	08/12/2020 06:42	08/12/2020 15:56	9,23	2	18,46	CHI
20201236983	GOIATUBA	GT12293099	GOIATUBA S2	08/12/2020 06:42	08/12/2020 08:42	08/12/2020 06:42	08/12/2020 08:42	1,99	3	5,97	CHI
20201237002	PORANGATU	PO12230401	MARA ROSA	08/12/2020 06:42	08/12/2020 09:19	08/12/2020 06:42	08/12/2020 09:19	2,60	5	13,00	CHI
20201237378	AGUA FRIA DE GOIAS	JL12261887	SAO JOAO D ALIANCA	08/12/2020 06:42	08/12/2020 09:35	08/12/2020 06:42	08/12/2020 09:35	2,88	1	2,88	CHI
20201237378	SAO JOAO D ALIANCA	JL12261887	SAO JOAO D ALIANCA	08/12/2020 06:42	08/12/2020 09:35	08/12/2020 06:42	08/12/2020 09:35	2,88	5	14,40	CHI
20201237857	QUIRINOPOLIS	QI12306035	QUIRINOPOLIS	08/12/2020 06:42	08/12/2020 11:28	08/12/2020 06:42	08/12/2020 11:28	4,76	6	28,58	CHI
20201236770	CRISTALINA	KR21304923	CRISTALINA S2	08/12/2020 06:43	08/12/2020 09:36	08/12/2020 06:43	08/12/2020 09:36	2,87	1	2,87	CHI
20201238398	APORE	AE12193960	ITAJA S1	08/12/2020 06:47	08/12/2020 12:26	08/12/2020 06:47	08/12/2020 12:26	5,65	3	16,94	CHI
20201239065	PIRENOPOLIS	PV12381295	CORUMBA	08/12/2020 06:47	08/12/2020 17:13	08/12/2020 06:47	08/12/2020 17:13	10,43	4	41,70	CHI
20201236412	CAIAPONIA	DP12182008LD	JATAI S1	08/12/2020 06:49	08/12/2020 11:30	08/12/2020 06:49	08/12/2020 11:30	4,69	20	93,83	CHI
20201236412	JATAI	DP12182008LD	JATAI S1	08/12/2020 06:49	08/12/2020 11:30	08/12/2020 06:49	08/12/2020 11:30	4,69	304	1426,27	CHI
20201236412	PEROLANDIA	DP12182008LD	JATAI S1	08/12/2020 06:49	08/12/2020 11:30	08/12/2020 06:49	08/12/2020 11:30	4,69	14	65,68	CHI
20201236800	CUMARI	CY21034708	CATALAO S1	08/12/2020 06:49	08/12/2020 10:00	08/12/2020 06:49	08/12/2020 10:00	3,18	1	3,18	CHI
20201236855	BURITI DE GOIAS	CO12206018RE	FIRMINOPOLIS S2	08/12/2020 06:50	08/12/2020 09:55	08/12/2020 06:50	08/12/2020 09:55	3,07	70	214,96	CHI
20201236855	NOVO BRASIL	CO12206018RE	FIRMINOPOLIS S2	08/12/2020 06:50	08/12/2020 09:55	08/12/2020 06:50	08/12/2020 09:55	3,07	16	49,13	CHI
20201236855	CORREGO DO OURO	CO12206018RE	FIRMINOPOLIS S2	08/12/2020 06:50	08/12/2020 09:55	08/12/2020 06:50	08/12/2020 09:55	3,07	87	267,16	CHI
20201237187	SERRANOPOLIS	SX12166103	JATAI S1	08/12/2020 06:50	08/12/2020 09:38	08/12/2020 06:50	08/12/2020 09:38	2,79	5	13,96	CHI
20201236812	TRINDADE	40227911	TRINDADE	08/12/2020 06:51	08/12/2020 09:45	08/12/2020 06:51	08/12/2020 09:45	2,89	1	2,89	CHI
20201236813	ITAJA	IJ12200688	ITAJA S2	08/12/2020 06:51	08/12/2020 08:54	08/12/2020 06:51	08/12/2020 08:54	2,04	4	8,15	CHI
20201236817	JUSSARA	BT12009785	BRITANIA	08/12/2020 06:52	09/12/2020 12:40	08/12/2020 06:52	09/12/2020 02:02	19,16	1	19,16	CHI
20201236817	BRITANIA	BT12009785	BRITANIA	08/12/2020 06:52	09/12/2020 12:40	08/12/2020 06:52	09/12/2020 02:02	19,16	3	57,48	CHI
20201236817	JUSSARA	BT12009785	BRITANIA	08/12/2020 06:52	09/12/2020 12:40	09/12/2020 02:03	09/12/2020 12:40	10,62	1	10,62	CHI
20201236817	BRITANIA	BT12009785	BRITANIA	08/12/2020 06:52	09/12/2020 12:40	09/12/2020 02:03	09/12/2020 12:40	10,62	3	31,86	CHI
20201237290	CEZARINA	CZ12206361	CEZARINA	08/12/2020 06:53	08/12/2020 10:51	08/12/2020 06:53	08/12/2020 10:51	3,96	20	79,29	CHI
20201236825	SAO MIGUEL DO ARAGUAIA	SM12013034	SAO MIGUEL DO ARAGUAIA	08/12/2020 06:54	08/12/2020 09:17	08/12/2020 06:54	08/12/2020 09:17	2,38	17	40,43	CHI
20201236827	CACU	JT12027736	CACHOEIRA ALTA	08/12/2020 06:54	08/12/2020 10:30	08/12/2020 06:54	08/12/2020 10:30	3,59	2	7,18	CHI
20201236830	NOVA ROMA	ND21242839	IACIARA S2	08/12/2020 06:54	08/12/2020 11:39	08/12/2020 06:54	08/12/2020 11:39	4,74	1	4,74	CHI

20201237582	JATAI	JT12264366	JATAI S2	08/12/2020 06:54	08/12/2020 14:15	08/12/2020 06:54	08/12/2020 14:15	7,36	67	492,86	CHI
20201240520	MATRINCHA	MP12199954	MATRINCHA	08/12/2020 06:54	09/12/2020 17:37	08/12/2020 06:54	09/12/2020 17:37	34,71	4	138,82	CHI
20201236836	PLANALTINA	TL12206256	SAO JOAO D ALIANCA	08/12/2020 06:56	08/12/2020 13:21	08/12/2020 06:56	08/12/2020 13:21	6,41	4	25,62	CHI
20201236838	GOIANIA	GN12001049	XAVANTES	08/12/2020 06:57	08/12/2020 09:25	08/12/2020 06:57	08/12/2020 09:25	2,46	5	12,31	CHI
20201237580	MORRINHOS	GT12052886	GOIATUBA S1	08/12/2020 06:57	08/12/2020 11:57	08/12/2020 06:57	08/12/2020 11:57	4,99	10	49,88	CHI
20201236847	GOUVELANDIA	QI12000329	QUIRINOPOLIS	08/12/2020 06:58	09/12/2020 01:22	08/12/2020 06:58	09/12/2020 01:22	18,39	1	18,39	CHI
20201236848	IACIARA	IA12000014	IACIARA S1	08/12/2020 06:58	08/12/2020 16:16	08/12/2020 06:58	08/12/2020 10:14	3,27	2	6,54	CHI
20201236848	IACIARA	IA12000014	IACIARA S1	08/12/2020 06:58	08/12/2020 16:16	08/12/2020 06:58	08/12/2020 15:55	8,95	3	26,86	CHI
20201236848	IACIARA	IA12195949	IACIARA S1	08/12/2020 06:58	08/12/2020 16:16	08/12/2020 08:52	08/12/2020 16:16	7,41	19	140,70	CHI
20201237604	CRIXAS	CX12202125	SERRA DO OURO	08/12/2020 06:58	08/12/2020 10:13	08/12/2020 06:58	08/12/2020 10:13	3,24	3	9,73	CHI
20201237210	ALEXANIA	AX12402045	ALEXANIA	08/12/2020 06:59	09/12/2020 09:48	08/12/2020 18:14	08/12/2020 18:55	0,67	171	115,38	CHI
20201237210	SANTO ANTONIO DO DESCOBERTO	AX12402045	ALEXANIA	08/12/2020 06:59	09/12/2020 09:48	08/12/2020 18:14	08/12/2020 18:55	0,67	1	0,67	CHI
20201237210	ALEXANIA	AX12402045	ALEXANIA	08/12/2020 06:59	09/12/2020 09:48	08/12/2020 06:59	09/12/2020 09:48	26,82	18	482,78	CHI
20201237402	PETROLINA DE GOIAS	PG12297933	PETROLINA	08/12/2020 06:59	08/12/2020 11:20	08/12/2020 06:59	08/12/2020 11:20	4,34	14	60,73	CHI
20201237270	CALDAS NOVAS	CN11246580	SERRA DE CALDAS	08/12/2020 07:00	08/12/2020 09:19	08/12/2020 07:00	08/12/2020 09:19	2,32	79	183,63	CHI
20201237486	LUZIANIA	LZ12304995	VIANOPOLIS	08/12/2020 07:00	08/12/2020 10:03	08/12/2020 07:00	08/12/2020 10:03	3,03	8	24,28	CHI
20201237486	ORIZONA	LZ12304995	VIANOPOLIS	08/12/2020 07:00	08/12/2020 10:03	08/12/2020 07:00	08/12/2020 10:03	3,03	87	264,02	CHI
20201237855	PARAUNA	EU12044261	ACREUNA	08/12/2020 07:00	09/12/2020 17:58	08/12/2020 07:00	09/12/2020 17:58	34,96	10	349,64	CHI
20201236868	APORE	AE21136293	ITAJA S1	08/12/2020 07:01	08/12/2020 10:51	08/12/2020 07:01	08/12/2020 10:51	3,82	1	3,82	CHI
20201237460	CACU	CC12021384	CACHOEIRA ALTA	08/12/2020 07:01	08/12/2020 11:21	08/12/2020 07:01	08/12/2020 11:21	4,33	12	51,96	CHI
20201236894	CATALAO	CT12333668	CATALAO S1	08/12/2020 07:02	08/12/2020 09:46	08/12/2020 07:02	08/12/2020 09:46	2,73	6	16,35	CHI
20201237141	PIRACANJUBA	PJ12013344	MORRINHOS	08/12/2020 07:02	08/12/2020 09:48	08/12/2020 07:02	08/12/2020 09:48	2,77	12	33,18	CHI
20201237160	BALIZA	BH12369819	BOM JARDIM	08/12/2020 07:02	08/12/2020 08:32	08/12/2020 07:02	08/12/2020 08:32	1,49	2	2,97	CHI
20201238273	INDIARA	IY12308502	CEZARINA	08/12/2020 07:03	08/12/2020 11:30	08/12/2020 07:03	08/12/2020 11:30	4,44	2	8,88	CHI
20201238273	CEZARINA	IY12308502	CEZARINA	08/12/2020 07:03	08/12/2020 11:30	08/12/2020 07:03	08/12/2020 11:30	4,44	4	17,75	CHI
20201238406	SANTA ROSA DE GOIAS	SR12019043	INHUMAS S1	08/12/2020 07:03	08/12/2020 15:25	08/12/2020 07:03	08/12/2020 15:25	8,36	3	25,07	CHI
20201236887	CRIXAS	CX12208559	SERRA DO OURO	08/12/2020 07:04	08/12/2020 12:13	08/12/2020 07:04	08/12/2020 12:13	5,15	5	25,73	CHI
20201236892	ITUMBIARA	IT11062934	ITUMBIARA NOVA	08/12/2020 07:05	08/12/2020 13:00	08/12/2020 07:05	08/12/2020 13:00	5,92	109	644,89	CHI
20201236895	AMORINOPOLIS	AM12039409	IPORA	08/12/2020 07:05	09/12/2020 08:21	08/12/2020 07:05	09/12/2020 08:21	25,26	4	101,03	CHI
20201236895	IPORA	AM12039409	IPORA	08/12/2020 07:05	09/12/2020 08:21	08/12/2020 07:05	09/12/2020 08:21	25,26	1	25,26	CHI
20201237023	SAO DOMINGOS	02090424	SAO DOMINGOS	08/12/2020 07:05	08/12/2020 07:14	08/12/2020 07:11	08/12/2020 07:14	0,06	1213	74,80	CHI
20201237023	GUARANI DE GOIAS	02090424	SAO DOMINGOS	08/12/2020 07:05	08/12/2020 07:14	08/12/2020 07:11	08/12/2020 07:14	0,06	151	9,31	CHI
20201237023	NOVA ROMA	02090424	SAO DOMINGOS	08/12/2020 07:05	08/12/2020 07:14	08/12/2020 07:11	08/12/2020 07:14	0,06	3	0,19	CHI
20201237023	MONTE ALEGRE DE GOIAS	02090424	SAO DOMINGOS	08/12/2020 07:05	08/12/2020 07:14	08/12/2020 07:11	08/12/2020 07:14	0,06	1	0,06	CHI
20201236903	MOZARLANDIA	MZ21241143	MOZARLANDIA	08/12/2020 07:06	08/12/2020 10:10	08/12/2020 07:06	08/12/2020 10:10	3,07	1	3,07	CHI
20201236911	CRIXAS	CX12248286	SERRA DO OURO	08/12/2020 07:06	08/12/2020 09:24	08/12/2020 07:06	08/12/2020 09:24	2,29	17	38,88	CHI
20201237611	PIRENOPOLIS	PV12382302	SAO FRANCISCO DE GOIAS	08/12/2020 07:06	08/12/2020 11:30	08/12/2020 07:06	08/12/2020 11:30	4,39	6	26,35	CHI
20201237804	JUSSARA	JR12055958	JUSSARA	08/12/2020 07:06	08/12/2020 13:30	08/12/2020 07:06	08/12/2020 13:30	6,41	8	51,24	CHI
20201236919	ABADIA DE GOIAS	5584380780	CARAIAS S1	08/12/2020 07:07	08/12/2020 09:56	08/12/2020 07:07	08/12/2020 09:56	2,81	1	2,81	CHI
20201236921	VALPARAISO DE GOIAS	10008315165	PACAEMBU S1	08/12/2020 07:07	08/12/2020 10:02	08/12/2020 07:07	08/12/2020 10:02	2,90	1	2,90	CHI
20201236927	RIO VERDE	RV21000224	RIO VERDE S1	08/12/2020 07:09	08/12/2020 08:11	08/12/2020 07:09	08/12/2020 08:11	1,03	1	1,03	CHI
20201236929	CRISTALINA	KR21328685	CRISTALINA S2	08/12/2020 07:09	08/12/2020 09:19	08/12/2020 07:09	08/12/2020 09:19	2,16	1	2,16	CHI
20201236930	HIDROLANDIA	HD21043185	PONTALINA	08/12/2020 07:09	08/12/2020 15:39	08/12/2020 07:09	08/12/2020 15:39	8,49	1	8,49	CHI
20201236956	CAMPINORTE	MQ12028706	MARA ROSA	08/12/2020 07:09	08/12/2020 14:31	08/12/2020 07:09	08/12/2020 14:31	7,37	3	22,10	CHI
20201236938	TRINDADE	40185369	TRINDADE	08/12/2020 07:10	08/12/2020 10:59	08/12/2020 07:10	08/12/2020 10:59	3,81	1	3,81	CHI
20201236939	NOVA AURORA	NE21406533	CATALAO S1	08/12/2020 07:10	08/12/2020 12:40	08/12/2020 07:10	08/12/2020 12:40	5,49	2	10,98	CHI
20201237345	CRISTALINA	KR12025856	PAMPLONA	08/12/2020 07:10	08/12/2020 09:31	08/12/2020 07:10	08/12/2020 09:31	2,34	7	16,35	CHI
20201237248	FORMOSA	FA12383249	ITUIQUIRA	08/12/2020 07:11	08/12/2020 09:17	08/12/2020 07:11	08/12/2020 09:17	2,09	10	20,89	CHI
20201236950	CALDAS NOVAS	CN21359924	CALDAS NOVAS S1	08/12/2020 07:12	08/12/2020 14:58	08/12/2020 07:12	08/12/2020 14:58	7,76	1	7,76	CHI
20201237110	QUIRINOPOLIS	QI12054841	QUIRINOPOLIS	08/12/2020 07:13	08/12/2020 11:18	08/12/2020 07:13	08/12/2020 11:18	4,08	17	69,28	CHI
20201237110	PARANAIGUARA	QI12054841	QUIRINOPOLIS	08/12/2020 07:13	08/12/2020 11:18	08/12/2020 07:13	08/12/2020 11:18	4,08	1	4,08	CHI

20201237181	NOVA IGUACU DE GOIAS	NH12232436	SANTA TEREZINHA	08/12/2020 07:13	09/12/2020 21:30	08/12/2020 07:13	09/12/2020 21:30	38,28	25	956,95	CHI
20201236965	CORUMBAIBA	CI21234666	VILA CORUMBA	08/12/2020 07:14	08/12/2020 13:12	08/12/2020 07:14	08/12/2020 13:12	5,96	1	5,96	CHI
20201236937	PILAR DE GOIAS	19695166	SANTA TEREZINHA	08/12/2020 07:15	08/12/2020 14:44	08/12/2020 07:15	08/12/2020 14:44	7,48	2	14,96	CHI
20201236979	QUIRINOPOLIS	QI21091053	QUIRINOPOLIS	08/12/2020 07:15	08/12/2020 09:53	08/12/2020 07:15	08/12/2020 09:53	2,63	1	2,63	CHI
20201236988	LUZIANIA	LZ12362715LD	RIO VERMELHO	08/12/2020 07:16	08/12/2020 10:22	08/12/2020 07:16	08/12/2020 10:22	3,09	2	6,19	CHI
20201236996	CATALAO	CT21333395	CATALAO S1	08/12/2020 07:16	08/12/2020 10:43	08/12/2020 07:16	08/12/2020 10:43	3,44	1	3,44	CHI
20201239256	BOM JESUS DE GOIAS	BJ12305405	BOM JESUS DE GOIAS	08/12/2020 07:16	08/12/2020 15:09	08/12/2020 07:16	08/12/2020 15:09	7,87	9	70,85	CHI
20201236998	BOM JESUS DE GOIAS	BJ21293040	BOM JESUS DE GOIAS	08/12/2020 07:17	08/12/2020 19:24	08/12/2020 07:17	08/12/2020 18:17	11,01	1	11,01	CHI
20201236998	BOM JESUS DE GOIAS	BJ21366461	BOM JESUS DE GOIAS	08/12/2020 07:17	08/12/2020 19:24	08/12/2020 07:17	08/12/2020 18:35	11,30	1	11,30	CHI
20201236998	BOM JESUS DE GOIAS	BJ21378074	BOM JESUS DE GOIAS	08/12/2020 07:17	08/12/2020 19:24	08/12/2020 07:17	08/12/2020 19:24	12,12	1	12,12	CHI
20201236999	GUARANI DE GOIAS	GY12294198	IACIARA S1	08/12/2020 07:17	08/12/2020 11:20	08/12/2020 07:17	08/12/2020 11:20	4,05	127	513,86	CHI
20201236999	IACIARA	GY12294198	IACIARA S1	08/12/2020 07:17	08/12/2020 11:20	08/12/2020 07:17	08/12/2020 11:20	4,05	2	8,09	CHI
20201237203	ITAUCU	IX12321580	INHUMAS S1	08/12/2020 07:17	08/12/2020 09:38	08/12/2020 07:17	08/12/2020 09:38	2,35	6	14,08	CHI
20201237008	CRISTALINA	KR21403556	CRISTALINA S2	08/12/2020 07:18	08/12/2020 11:38	08/12/2020 07:18	08/12/2020 11:38	4,33	1	4,33	CHI
20201237009	NOVA AURORA	NE21157541	CATALAO S1	08/12/2020 07:18	08/12/2020 10:01	08/12/2020 07:18	08/12/2020 10:01	2,71	1	2,71	CHI
20201237010	TROMBAS	TB12391646	PORANGATU	08/12/2020 07:18	08/12/2020 09:16	08/12/2020 07:18	08/12/2020 09:16	1,96	6	11,73	CHI
20201237606	CAMPINACU	UC12354229	MARA ROSA	08/12/2020 07:19	08/12/2020 19:42	08/12/2020 07:19	08/12/2020 19:42	12,38	17	210,51	CHI
20201237022	GOUVELANDIA	GB31067502	QUIRINOPOLIS	08/12/2020 07:20	08/12/2020 10:49	08/12/2020 07:20	08/12/2020 10:49	3,47	1	3,47	CHI
20201237024	SAO JOAO DA PARAUNA	PU12103715	FIRMINOPOLIS S2	08/12/2020 07:21	08/12/2020 11:10	08/12/2020 07:21	08/12/2020 11:10	3,82	1	3,82	CHI
20201237027	MINEIROS	MY21322116	PARQUE DAS EMAS	08/12/2020 07:21	08/12/2020 19:27	08/12/2020 07:21	08/12/2020 19:27	12,09	1	12,09	CHI
20201238399	APORE	3110009351	ITAJA S1	08/12/2020 07:21	08/12/2020 11:17	08/12/2020 07:21	08/12/2020 11:17	3,92	1	3,92	CHI
20201237030	AMORINOPOLIS	AM21138518	IPORA	08/12/2020 07:22	08/12/2020 22:41	08/12/2020 07:22	08/12/2020 22:41	15,32	1	15,32	CHI
20201237034	AGUA FRIA DE GOIAS	TL21180596	SAO JOAO D ALIANCA	08/12/2020 07:23	08/12/2020 18:54	08/12/2020 07:23	08/12/2020 18:54	11,52	1	11,52	CHI
20201237050	PIRENOPOLIS	PV21196873	CORUMBA	08/12/2020 07:23	08/12/2020 22:15	08/12/2020 07:23	08/12/2020 22:15	14,85	2	29,71	CHI
20201237055	CALDAS NOVAS	CN21354077	SERRA DE CALDAS	08/12/2020 07:24	08/12/2020 10:12	08/12/2020 07:24	08/12/2020 10:12	2,80	1	2,80	CHI
20201237059	JUSSARA	JR21118180	BRITANIA	08/12/2020 07:24	08/12/2020 11:35	08/12/2020 07:24	08/12/2020 11:35	4,18	1	4,18	CHI
20201237060	QUIRINOPOLIS	QI12260995	QUIRINOPOLIS	08/12/2020 07:24	08/12/2020 10:09	08/12/2020 07:24	08/12/2020 10:09	2,73	2	5,47	CHI
20201237458	ALVORADA DO NORTE	FB12206226	IACIARA S2	08/12/2020 07:24	08/12/2020 11:48	08/12/2020 07:24	08/12/2020 11:48	4,39	20	87,87	CHI
20201237458	FLORES DE GOIAS	FB12206226	IACIARA S2	08/12/2020 07:24	08/12/2020 11:48	08/12/2020 07:24	08/12/2020 11:48	4,39	1	4,39	CHI
20201237065	COCALZINHO DE GOIAS	ZN21101425	COCALZINHO	08/12/2020 07:25	08/12/2020 14:38	08/12/2020 07:25	08/12/2020 14:38	7,21	1	7,21	CHI
20201237068	CACU	CC12235900	CACHOEIRA ALTA	08/12/2020 07:25	08/12/2020 11:47	08/12/2020 07:25	08/12/2020 11:47	4,36	1	4,36	CHI
20201237070	NIQUELANDIA	10004943030	NIQUELANDIA SUBTRANSMISSAO	08/12/2020 07:25	08/12/2020 08:51	08/12/2020 07:25	08/12/2020 08:51	1,42	1	1,42	CHI
20201237982	LUZIANIA	LZ12336007	RIO VERMELHO	08/12/2020 07:25	08/12/2020 12:20	08/12/2020 07:25	08/12/2020 12:20	4,91	88	431,76	CHI
20201237636	PALESTINA DE GOIAS	PY12396111	PALESTINA	08/12/2020 07:26	08/12/2020 14:09	08/12/2020 07:26	08/12/2020 14:09	6,71	12	80,50	CHI
20201237636	CAIAPONIA	PY12396111	PALESTINA	08/12/2020 07:26	08/12/2020 14:09	08/12/2020 07:26	08/12/2020 14:09	6,71	18	120,75	CHI
20201237648	ACREUNA	EU12403890	ACREUNA	08/12/2020 07:26	08/12/2020 09:17	08/12/2020 07:26	08/12/2020 09:17	1,84	15	27,53	CHI
20201238998	POSSE	PS12232228	IACIARA S2	08/12/2020 07:26	08/12/2020 14:39	08/12/2020 07:26	08/12/2020 14:39	7,21	4	28,84	CHI
20201236730	JATAI	JT12000179	JATAI S2	08/12/2020 07:27	08/12/2020 09:47	08/12/2020 07:27	08/12/2020 09:47	2,32	4	9,30	CHI
20201237079	NOVA VENEZA	NV21188763	INHUMAS S1	08/12/2020 07:27	08/12/2020 12:10	08/12/2020 07:27	08/12/2020 12:10	4,71	2	9,42	CHI
20201237082	PIRACANJUBA	PJ12320300	ROCHEDO	08/12/2020 07:27	08/12/2020 11:49	08/12/2020 07:27	08/12/2020 11:49	4,36	2	8,72	CHI
20201237086	CAIAPONIA	CP12054806	CAIAPONIA	08/12/2020 07:27	08/12/2020 15:52	08/12/2020 07:27	08/12/2020 15:52	8,40	3	25,21	CHI
20201237437	BOM JESUS DE GOIAS	BJ12000005	BOM JESUS DE GOIAS	08/12/2020 07:27	08/12/2020 10:45	08/12/2020 07:27	08/12/2020 10:45	3,29	192	632,53	CHI
20201237088	PALESTINA DE GOIAS	3370003361	PALESTINA	08/12/2020 07:28	08/12/2020 17:47	08/12/2020 07:28	08/12/2020 17:47	10,31	1	10,31	CHI
20201237089	PADRE BERNARDO	PB21273332	PADRE BERNARDO	08/12/2020 07:28	08/12/2020 09:46	08/12/2020 07:28	08/12/2020 09:46	2,29	1	2,29	CHI
20201237092	PARANAIGUARA	PC12271707	QUIRINOPOLIS	08/12/2020 07:29	08/12/2020 10:11	08/12/2020 07:29	08/12/2020 10:11	2,70	5	13,50	CHI
20201237093	BURITI DE GOIAS	BS21209327	FIRMINOPOLIS S2	08/12/2020 07:29	08/12/2020 13:13	08/12/2020 07:29	08/12/2020 13:13	5,73	2	11,46	CHI
20201237096	GOIATUBA	GT21052922	GOIATUBA S1	08/12/2020 07:29	08/12/2020 11:48	08/12/2020 07:29	08/12/2020 11:48	4,31	1	4,31	CHI
20201237097	MIMOSO DE GOIAS	MJ12251065	PADRE BERNARDO	08/12/2020 07:29	08/12/2020 11:11	08/12/2020 07:29	08/12/2020 11:11	3,69	10	36,90	CHI
20201237100	MINACU	IH11212284	MINACU	08/12/2020 07:29	08/12/2020 17:04	08/12/2020 07:29	08/12/2020 17:04	9,57	3	28,70	CHI
20201237103	PARAUNA	PU12391520	FIRMINOPOLIS S2	08/12/2020 07:30	09/12/2020 00:14	08/12/2020 07:30	09/12/2020 00:14	16,73	2	33,45	CHI
20201237510	FAZENDA NOVA	FN12396225	JUSSARA	08/12/2020 07:30	08/12/2020 16:19	08/12/2020 07:30	08/12/2020 16:19	8,81	10	88,10	CHI

20201237117	GOIANIA	10041680	CAMPINAS S1	08/12/2020 07:31	08/12/2020 08:53	08/12/2020 07:31	08/12/2020 08:53	1,35	1	1,35	CHI
20201237119	LUZIANIA	LZ11214875	RIO VERMELHO	08/12/2020 07:31	08/12/2020 10:48	08/12/2020 07:31	08/12/2020 10:48	3,27	20	65,42	CHI
20201237120	SITIO D ABADIA	SI12211381	IACIARA S2	08/12/2020 07:31	08/12/2020 08:56	08/12/2020 07:31	08/12/2020 08:56	1,40	28	39,25	CHI
20201237121	PETROLINA DE GOIAS	PG12101435	PETROLINA	08/12/2020 07:31	08/12/2020 14:35	08/12/2020 07:31	08/12/2020 14:35	7,05	4	28,21	CHI
20201237228	PIRES DO RIO	PR11083250	PIRES DO RIO S1	08/12/2020 07:31	08/12/2020 10:00	08/12/2020 07:31	08/12/2020 10:00	2,47	137	338,58	CHI
20201236990	BOM JESUS DE GOIAS	BJ12000133	BOM JESUS DE GOIAS	08/12/2020 07:32	08/12/2020 13:30	08/12/2020 07:32	08/12/2020 13:30	5,96	3	17,88	CHI
20201239257	QUIRINOPOLIS	BJ12000137RE	BOM JESUS DE GOIAS	08/12/2020 07:32	08/12/2020 13:49	08/12/2020 07:32	08/12/2020 13:49	6,27	2	12,54	CHI
20201239257	BOM JESUS DE GOIAS	BJ12000137RE	BOM JESUS DE GOIAS	08/12/2020 07:32	08/12/2020 13:49	08/12/2020 07:32	08/12/2020 13:49	6,27	13	81,50	CHI
20201237136	ARAGARCAS	BM12316457	BOM JARDIM	08/12/2020 07:33	08/12/2020 10:42	08/12/2020 07:33	08/12/2020 10:42	3,14	2	6,29	CHI
20201237136	BOM JARDIM DE GOIAS	BM12316457	BOM JARDIM	08/12/2020 07:33	08/12/2020 10:42	08/12/2020 07:33	08/12/2020 10:42	3,14	3	9,43	CHI
20201237140	INACIOLANDIA	ID32128218	CACHOEIRA DOURADA	08/12/2020 07:33	09/12/2020 11:34	08/12/2020 07:33	09/12/2020 11:34	28,00	3	84,01	CHI
20201237145	SAO LUIZ DO NORTE	SZ12073508	BARRO ALTO	08/12/2020 07:34	08/12/2020 11:48	08/12/2020 07:34	08/12/2020 11:48	4,23	2	8,45	CHI
20201237146	CORUMBAIBA	CI21000480	VILA CORUMBA	08/12/2020 07:34	08/12/2020 14:01	08/12/2020 07:34	08/12/2020 14:01	6,44	1	6,44	CHI
20201237148	PADRE BERNARDO	PB12382210	PADRE BERNARDO	08/12/2020 07:34	08/12/2020 09:13	08/12/2020 07:34	08/12/2020 09:13	1,64	38	62,32	CHI
20201237157	CORUMBAIBA	CI21107557	VILA CORUMBA	08/12/2020 07:35	08/12/2020 09:51	08/12/2020 07:35	08/12/2020 09:51	2,25	1	2,25	CHI
20201237167	FAINA	FC12084192	GOIAS	08/12/2020 07:36	08/12/2020 13:08	08/12/2020 07:36	08/12/2020 13:08	5,52	3	16,56	CHI
20201237170	AMARALINA	LC12270741	SAO MIGUEL DO ARAGUAIA	08/12/2020 07:37	08/12/2020 12:42	08/12/2020 07:37	08/12/2020 12:42	5,07	10	50,71	CHI
20201237810	GOIATUBA	BJ12000207	CACHOEIRA DOURADA	08/12/2020 07:37	09/12/2020 10:00	08/12/2020 07:37	09/12/2020 10:00	26,38	1	26,38	CHI
20201237810	PANAMA	BJ12000207	CACHOEIRA DOURADA	08/12/2020 07:37	09/12/2020 10:00	08/12/2020 07:37	09/12/2020 10:00	26,38	2	52,77	CHI
20201237810	BOM JESUS DE GOIAS	BJ12000207	CACHOEIRA DOURADA	08/12/2020 07:37	09/12/2020 10:00	08/12/2020 07:37	09/12/2020 10:00	26,38	4	105,53	CHI
20201237172	TRINDADE	10026363907	TRINDADE	08/12/2020 07:38	08/12/2020 12:35	08/12/2020 07:38	08/12/2020 12:35	4,94	1	4,94	CHI
20201237174	CACHOEIRA ALTA	CA12075132RE	CACHOEIRA ALTA	08/12/2020 07:38	08/12/2020 13:38	08/12/2020 07:38	08/12/2020 13:38	5,99	23	137,67	CHI
20201237185	SILVANIA	SV21300697	DAIA S2	08/12/2020 07:40	08/12/2020 12:31	08/12/2020 07:40	08/12/2020 12:31	4,84	1	4,84	CHI
20201237194	CAMPOS BELOS	MA12240205	SAO DOMINGOS	08/12/2020 07:42	08/12/2020 14:15	08/12/2020 07:42	08/12/2020 14:15	6,55	1	6,55	CHI
20201237194	MONTE ALEGRE DE GOIAS	MA12240205	SAO DOMINGOS	08/12/2020 07:42	08/12/2020 14:15	08/12/2020 07:42	08/12/2020 14:15	6,55	9	58,94	CHI
20201237200	NOVO GAMA	NJ12383038LD	PACAEMBU S1	08/12/2020 07:42	08/12/2020 12:18	08/12/2020 07:42	08/12/2020 08:56	1,23	26	32,01	CHI
20201237200	NOVO GAMA	NJ12383038LD	PACAEMBU S1	08/12/2020 07:42	08/12/2020 12:18	08/12/2020 08:57	08/12/2020 12:18	3,35	26	87,19	CHI
20201238710	MARA ROSA	ET12094052	MARA ROSA	08/12/2020 07:42	08/12/2020 23:30	08/12/2020 07:42	08/12/2020 23:30	15,79	40	631,47	CHI
20201238710	ESTRELA DO NORTE	ET12094052	MARA ROSA	08/12/2020 07:42	08/12/2020 23:30	08/12/2020 07:42	08/12/2020 23:30	15,79	16	252,59	CHI
20201238771	MINEIROS	MY12156849	PARQUE DAS EMAS	08/12/2020 07:42	08/12/2020 14:58	08/12/2020 07:42	08/12/2020 14:58	7,25	11	79,77	CHI
20201237212	CAIAPONIA	AM21136161	IPORA	08/12/2020 07:43	09/12/2020 09:50	08/12/2020 07:43	09/12/2020 09:50	26,12	1	26,12	CHI
20201237218	NIQUELANDIA	2750001062	NIQUELANDIA SUBTRANSMISSAO	08/12/2020 07:44	08/12/2020 12:06	08/12/2020 07:44	08/12/2020 12:06	4,36	1	4,36	CHI
20201237221	FORMOSA	FA21376628	ITUIQUIRA	08/12/2020 07:44	08/12/2020 09:22	08/12/2020 07:44	08/12/2020 09:22	1,63	1	1,63	CHI
20201237492	MIMOSO DE GOIAS	MJ12249518	PADRE BERNARDO	08/12/2020 07:44	08/12/2020 11:09	08/12/2020 07:44	08/12/2020 11:09	3,41	49	167,09	CHI
20201237223	SAO SIMAO	SO21338612	CACHOEIRA ALTA	08/12/2020 07:45	08/12/2020 11:43	08/12/2020 07:45	08/12/2020 11:43	3,96	1	3,96	CHI
20201237225	GOIANESIA	GE21215137	GOIANESIA S2	08/12/2020 07:45	08/12/2020 17:00	08/12/2020 07:45	08/12/2020 17:00	9,24	1	9,24	CHI
20201237227	APORE	AE12059186	ITAJA S1	08/12/2020 07:45	08/12/2020 17:03	08/12/2020 07:45	08/12/2020 17:03	9,29	4	37,15	CHI
20201237244	MUTUNOPOLIS	MU12068529	MARA ROSA	08/12/2020 07:45	08/12/2020 10:39	08/12/2020 07:45	08/12/2020 10:39	2,89	44	127,18	CHI
20201237244	PORANGATU	MU12068529	MARA ROSA	08/12/2020 07:45	08/12/2020 10:39	08/12/2020 07:45	08/12/2020 10:39	2,89	12	34,69	CHI
20201237231	ALEXANIA	AX12297691	ALEXANIA	08/12/2020 07:46	09/12/2020 17:19	08/12/2020 07:46	09/12/2020 10:34	26,81	29	777,42	CHI
20201237231	ALEXANIA	AX12297691	ALEXANIA	08/12/2020 07:46	09/12/2020 17:19	08/12/2020 07:46	09/12/2020 11:54	28,14	8	225,10	CHI
20201237231	ALEXANIA	AX12297691	ALEXANIA	08/12/2020 07:46	09/12/2020 17:19	08/12/2020 07:46	09/12/2020 17:19	33,55	10	335,47	CHI
20201237231	SANTO ANTONIO DO DESCOBERTO	AX12297691	ALEXANIA	08/12/2020 07:46	09/12/2020 17:19	08/12/2020 07:46	09/12/2020 17:19	33,55	1	33,55	CHI
20201237237	GOIAS	8703062	MATRINCHA	08/12/2020 07:47	08/12/2020 12:12	08/12/2020 07:47	08/12/2020 12:12	4,40	1	4,40	CHI
20201237241	BONOPOLIS	BX12328842	NOVO PLANALTO	08/12/2020 07:48	08/12/2020 11:23	08/12/2020 07:48	08/12/2020 11:23	3,58	1	3,58	CHI
20201237664	PONTALINA	AD12013446	GOIATUBA S1	08/12/2020 07:48	08/12/2020 13:56	08/12/2020 07:48	08/12/2020 13:56	6,12	13	79,61	CHI
20201237664	ALOANDIA	AD12013446	GOIATUBA S1	08/12/2020 07:48	08/12/2020 13:56	08/12/2020 07:48	08/12/2020 13:56	6,12	9	55,12	CHI
20201237249	BOM JESUS DE GOIAS	BJ12208036RE	BOM JESUS DE GOIAS	08/12/2020 07:49	08/12/2020 13:59	08/12/2020 07:49	08/12/2020 13:59	6,16	4	24,64	CHI
20201237249	GOIATUBA	BJ12208036RE	BOM JESUS DE GOIAS	08/12/2020 07:49	08/12/2020 13:59	08/12/2020 07:49	08/12/2020 13:59	6,16	1	6,16	CHI
20201237255	LUZIANIA	KR12304893	PAMPLONA	08/12/2020 07:50	08/12/2020 10:30	08/12/2020 07:50	08/12/2020 10:30	2,66	1	2,66	CHI
20201237261	FORMOSA	FA12361428	SAO JOAO D ALIANCA	08/12/2020 07:51	08/12/2020 13:40	08/12/2020 07:51	08/12/2020 13:40	5,81	2	11,61	CHI

20201237269	JUSSARA	JR12101970RE	BRITANIA	08/12/2020 07:52	08/12/2020 12:50	08/12/2020 07:52	08/12/2020 12:50	4,97	11	54,67	CHI
20201237272	MUNDO NOVO DE GOIAS	MH11274836	NOVA CRIXAS	08/12/2020 07:52	08/12/2020 09:44	08/12/2020 07:52	08/12/2020 09:44	1,86	1	1,86	CHI
20201237273	PILAR DE GOIAS	GG12166527	SANTA TEREZINHA	08/12/2020 07:52	08/12/2020 16:12	08/12/2020 07:52	08/12/2020 16:12	8,32	13	108,20	CHI
20201237273	SANTA TEREZINHA DE GOIAS	GG12166527	SANTA TEREZINHA	08/12/2020 07:52	08/12/2020 16:12	08/12/2020 07:52	08/12/2020 16:12	8,32	8	66,59	CHI
20201237274	BALIZA	BH11331094	CAIAPONIA	08/12/2020 07:52	08/12/2020 20:10	08/12/2020 07:52	08/12/2020 20:10	12,29	2	24,58	CHI
20201239979	FLORES DE GOIAS	FB12044974RE	IACIARA S2	08/12/2020 07:52	08/12/2020 18:56	08/12/2020 07:52	08/12/2020 18:56	11,06	7	77,41	CHI
20201237281	INACIOLANDIA	ID12293336	CACHOEIRA DOURADA	08/12/2020 07:53	08/12/2020 13:59	08/12/2020 07:53	08/12/2020 13:59	6,08	2	12,17	CHI
20201237288	GOIANIA	12378173	GOYA S2	08/12/2020 07:54	08/12/2020 11:01	08/12/2020 07:54	08/12/2020 11:01	3,11	1	3,11	CHI
20201237291	INHUMAS	IN21000216	ARACU	08/12/2020 07:55	08/12/2020 10:09	08/12/2020 07:55	08/12/2020 10:09	2,23	1	2,23	CHI
20201237292	NIQUELANDIA	NQ21055111	NIQUELANDIA SUBTRANSMISSAO	08/12/2020 07:55	08/12/2020 10:00	08/12/2020 07:55	08/12/2020 10:00	2,08	1	2,08	CHI
20201237297	ITABERAI	IB21387679	ITABERAI S1	08/12/2020 07:56	08/12/2020 09:20	08/12/2020 07:56	08/12/2020 09:20	1,40	1	1,40	CHI
20201237300	PIRENOPOLIS	10002708106	CORUMBA	08/12/2020 07:56	08/12/2020 19:15	08/12/2020 07:56	08/12/2020 19:15	11,31	1	11,31	CHI
20201237304	URUACU	UR21210907	URUACU	08/12/2020 07:57	08/12/2020 10:46	08/12/2020 07:57	08/12/2020 10:46	2,81	1	2,81	CHI
20201237307	GOIANIA	15689256	MEIA PONTE	08/12/2020 07:57	08/12/2020 09:59	08/12/2020 07:57	08/12/2020 09:59	2,03	1	2,03	CHI
20201237310	NOVO GAMA	2460043760	PACAEMBU S1	08/12/2020 07:57	08/12/2020 11:05	08/12/2020 07:57	08/12/2020 11:05	3,12	1	3,12	CHI
20201237689	POSSE	PS12124649	IACIARA S2	08/12/2020 07:57	08/12/2020 12:13	08/12/2020 07:57	08/12/2020 12:13	4,28	16	68,42	CHI
20201237689	POSSE	PS12124649	IACIARA S2	08/12/2020 07:57	08/12/2020 12:13	08/12/2020 12:00	08/12/2020 12:13	0,22	6	1,32	CHI
20201239287	PALESTINA DE GOIAS	PY12079592	PALESTINA	08/12/2020 07:57	08/12/2020 16:57	08/12/2020 07:57	08/12/2020 16:57	9,00	18	161,99	CHI
20201237316	FORMOSA	FA11397216	SAO JOAO D ALIANCA	08/12/2020 07:58	08/12/2020 18:01	08/12/2020 07:58	08/12/2020 18:01	10,03	1	10,03	CHI
20201230790	PALESTINA DE GOIAS	PY12027944	PALESTINA	08/12/2020 07:59	08/12/2020 14:23	08/12/2020 07:59	08/12/2020 14:23	6,40	54	345,39	CHI
20201235721	CAIAPONIA	7717556	PALESTINA	08/12/2020 07:59	08/12/2020 13:02	08/12/2020 07:59	08/12/2020 13:02	5,05	11	55,51	CHI
20201237319	QUIRINOPOLIS	QI21338657	QUIRINOPOLIS	08/12/2020 08:00	08/12/2020 17:58	08/12/2020 08:00	08/12/2020 17:58	9,96	1	9,96	CHI
20201237322	CACU	CC21028173	CACHOEIRA ALTA	08/12/2020 08:00	08/12/2020 08:39	08/12/2020 08:00	08/12/2020 08:39	0,64	1	0,64	CHI
20201239010	CAIAPONIA	CP12067935	CAIAPONIA	08/12/2020 08:01	08/12/2020 16:34	08/12/2020 08:01	08/12/2020 16:34	8,54	6	51,24	CHI
20201237332	CALDAS NOVAS	10016456376	CALDAS NOVAS S2	08/12/2020 08:02	08/12/2020 09:59	08/12/2020 08:02	08/12/2020 09:59	1,95	1	1,95	CHI
20201237343	RIO VERDE	RV12260695	CABRIUVA S1	08/12/2020 08:03	08/12/2020 10:28	08/12/2020 08:03	08/12/2020 10:28	2,41	14	33,67	CHI
20201237354	CRISTALINA	KR21261540	PAMPLONA	08/12/2020 08:04	08/12/2020 09:54	08/12/2020 08:04	08/12/2020 09:54	1,83	1	1,83	CHI
20201237355	GUARINOS	GG12316076	ITAPACI	08/12/2020 08:04	08/12/2020 12:32	08/12/2020 08:04	08/12/2020 12:32	4,45	3	13,36	CHI
20201238685	GOIANDIRA	GD21127633	CATALAO S1	08/12/2020 08:04	08/12/2020 13:22	08/12/2020 08:04	08/12/2020 13:22	5,28	1	5,28	CHI
20201237357	AMARALINA	LC12270203	SAO MIGUEL DO ARAGUAIA	08/12/2020 08:05	08/12/2020 11:19	08/12/2020 08:05	08/12/2020 11:19	3,23	9	29,10	CHI
20201237358	ABADIANA	SV12125412	DAIA S2	08/12/2020 08:05	08/12/2020 10:36	08/12/2020 08:05	08/12/2020 10:36	2,51	2	5,03	CHI
20201237358	GAMELEIRA DE GOIAS	SV12125412	DAIA S2	08/12/2020 08:05	08/12/2020 10:36	08/12/2020 08:05	08/12/2020 10:36	2,51	11	27,66	CHI
20201237362	LEOPOLDO DE BULHOES	BO12400463	CEPAIGO S2	08/12/2020 08:05	08/12/2020 10:00	08/12/2020 08:05	08/12/2020 10:00	1,90	12	22,81	CHI
20201237362	BONFINOPOLIS	BO12400463	CEPAIGO S2	08/12/2020 08:05	08/12/2020 10:00	08/12/2020 08:05	08/12/2020 10:00	1,90	28	53,22	CHI
20201237365	NOVO BRASIL	10013867880	JUSSARA	08/12/2020 08:06	08/12/2020 12:10	08/12/2020 08:06	08/12/2020 12:10	4,06	1	4,06	CHI
20201237366	ANAPOLIS	21152639	ANAPOLIS UNIVERSITARIO S1	08/12/2020 08:06	08/12/2020 09:31	08/12/2020 08:06	08/12/2020 09:31	1,40	1	1,40	CHI
20201237568	VARJAO	AO32097674	GUAPO S2	08/12/2020 08:06	08/12/2020 12:45	08/12/2020 08:06	08/12/2020 12:45	4,64	4	18,54	CHI
20201237372	ANAPOLIS	AN21247636	JUNDIAI S1	08/12/2020 08:07	08/12/2020 10:28	08/12/2020 08:07	08/12/2020 10:28	2,34	1	2,34	CHI
20201237377	ITABERAI	50087370	ITABERAI S2	08/12/2020 08:07	08/12/2020 09:13	08/12/2020 08:07	08/12/2020 09:13	1,09	1	1,09	CHI
20201237387	SAO LUIS DE MONTES BELOS	SL12259052	SAO LUIZ DOS MONTES BELOS	08/12/2020 08:08	08/12/2020 09:34	08/12/2020 08:08	08/12/2020 09:34	1,42	2	2,84	CHI
20201237388	CORUMBAIBA	CI12000486	VILA CORUMBA	08/12/2020 08:08	08/12/2020 12:52	08/12/2020 08:08	08/12/2020 12:52	4,72	4	18,88	CHI
20201237389	SAO MIGUEL DO ARAGUAIA	SM11358696	SAO MIGUEL DO ARAGUAIA	08/12/2020 08:08	08/12/2020 12:45	08/12/2020 08:08	08/12/2020 12:45	4,60	1	4,60	CHI
20201237632	PIRACANJUBA	PJ12263070	PIRACANJUBA	08/12/2020 08:08	08/12/2020 12:52	08/12/2020 08:08	08/12/2020 12:52	4,72	5	23,59	CHI
20201237405	VIANOPOLIS	VN12168187RE	VIANOPOLIS	08/12/2020 08:09	09/12/2020 21:11	08/12/2020 08:09	09/12/2020 14:20	30,18	8	241,47	CHI
20201237405	VIANOPOLIS	VN12168187RE	VIANOPOLIS	08/12/2020 08:09	09/12/2020 21:11	09/12/2020 20:05	09/12/2020 21:11	1,09	8	8,75	CHI
20201237405	VIANOPOLIS	VN12168187RE	VIANOPOLIS	08/12/2020 08:09	09/12/2020 21:11	08/12/2020 08:09	09/12/2020 21:11	37,04	5	185,22	CHI
20201237407	SANTA TEREZA DE GOIAS	SE12152442	MARA ROSA	08/12/2020 08:09	08/12/2020 11:09	08/12/2020 08:09	08/12/2020 11:09	2,99	1	2,99	CHI
20201237497	IACIARA	IA12392240	FLORES DE GOIAS	08/12/2020 08:09	08/12/2020 23:27	08/12/2020 08:09	08/12/2020 23:27	15,29	7	107,02	CHI
20201240051	PIRENOPOLIS	PV12334635	CORUMBA	08/12/2020 08:09	08/12/2020 16:30	08/12/2020 08:09	08/12/2020 16:30	8,35	8	66,80	CHI
20201237413	GUARAITA	IK12250614	ITAPURANGA	08/12/2020 08:10	08/12/2020 10:03	08/12/2020 08:10	08/12/2020 10:03	1,88	18	33,81	CHI
20201237413	ITAPURANGA	IK12250614	ITAPURANGA	08/12/2020 08:10	08/12/2020 10:03	08/12/2020 08:10	08/12/2020 10:03	1,88	22	41,32	CHI

20201237413	GOIAS	IK12250614	ITAPURANGA	08/12/2020 08:10	08/12/2020 10:03	08/12/2020 08:10	08/12/2020 10:03	1,88	2	3,76	CHI
20201237414	HIDROLANDIA	HD12389462	CEPAIGO S2	08/12/2020 08:10	08/12/2020 14:36	08/12/2020 08:10	08/12/2020 14:36	6,44	7	45,08	CHI
20201237424	MINEIROS	MY12324417	PARQUE DAS EMAS	08/12/2020 08:11	08/12/2020 12:22	08/12/2020 08:11	08/12/2020 12:22	4,18	2	8,36	CHI
20201237427	SANCLERLANDIA	SC12204364	FIRMINOPOLIS S2	08/12/2020 08:12	08/12/2020 16:33	08/12/2020 08:12	08/12/2020 16:33	8,34	2	16,68	CHI
20201237429	CORUMBAIBA	CI21000475	VILA CORUMBA	08/12/2020 08:12	09/12/2020 09:54	08/12/2020 08:12	09/12/2020 09:54	25,69	1	25,69	CHI
20201237434	PARAUNA	PU12205943RE	PARAUNA	08/12/2020 08:12	08/12/2020 19:56	08/12/2020 08:12	08/12/2020 13:12	4,99	8	39,92	CHI
20201237434	JANDAIA	PU12205943RE	PARAUNA	08/12/2020 08:12	08/12/2020 19:56	08/12/2020 08:12	08/12/2020 19:56	11,72	3	35,17	CHI
20201237434	PARAUNA	PU12205943RE	PARAUNA	08/12/2020 08:12	08/12/2020 19:56	08/12/2020 08:12	08/12/2020 19:56	11,72	20	234,50	CHI
20201237439	SANTA CRUZ DE GOIAS	BC12012519	PIRES DO RIO S2	08/12/2020 08:13	08/12/2020 20:40	08/12/2020 08:13	08/12/2020 20:40	12,43	2	24,87	CHI
20201237442	PARAUNA	PU12109627RE	PARAUNA	08/12/2020 08:14	08/12/2020 08:51	08/12/2020 08:14	08/12/2020 08:51	0,62	22	13,56	CHI
20201237533	GOIANIA	GN11218937	GOYA S1	08/12/2020 08:15	08/12/2020 09:40	08/12/2020 08:15	08/12/2020 09:40	1,41	62	87,21	CHI
20201238171	IPAMERI	KR12133609	CRISTALINA S1	08/12/2020 08:16	08/12/2020 11:44	08/12/2020 08:16	08/12/2020 11:44	3,45	5	17,27	CHI
20201238171	CRISTALINA	KR12133609	CRISTALINA S1	08/12/2020 08:16	08/12/2020 11:44	08/12/2020 08:16	08/12/2020 11:44	3,45	7	24,18	CHI
20201237453	CORUMBAIBA	CI21021240	VILA CORUMBA	08/12/2020 08:17	09/12/2020 10:35	08/12/2020 08:17	09/12/2020 10:35	26,30	1	26,30	CHI
20201237529	GOIANIA	GN11295098	CARAJAS S1	08/12/2020 08:17	08/12/2020 10:36	08/12/2020 08:17	08/12/2020 10:36	2,31	197	454,14	CHI
20201232851	DOVERLANDIA	DV12395478	CAIAPONIA	08/12/2020 08:18	08/12/2020 10:42	08/12/2020 08:18	08/12/2020 10:42	2,39	29	69,21	CHI
20201237466	EDEIA	EA21156873	EDEIA	08/12/2020 08:18	08/12/2020 12:28	08/12/2020 08:18	08/12/2020 12:28	4,16	1	4,16	CHI
20201237474	SAO MIGUEL DO ARAGUAIA	SM21374522	SAO MIGUEL DO ARAGUAIA	08/12/2020 08:18	08/12/2020 12:19	08/12/2020 08:18	08/12/2020 12:19	4,00	1	4,00	CHI
20201237476	PALMEIRAS DE GOIAS	PL12169788	PALMEIRAS	08/12/2020 08:18	08/12/2020 11:11	08/12/2020 08:18	08/12/2020 11:11	2,88	9	25,91	CHI
20201237922	PORANGATU	TA12114216	NOVO PLANALTO	08/12/2020 08:18	08/12/2020 12:57	08/12/2020 08:18	08/12/2020 12:57	4,64	6	27,83	CHI
20201237479	CRIXAS	CX21141801	SERRA DO OURO	08/12/2020 08:19	08/12/2020 10:06	08/12/2020 08:19	08/12/2020 10:06	1,78	1	1,78	CHI
20201237480	ITABERAI	IB21107107	ITABERAI S2	08/12/2020 08:19	08/12/2020 09:02	08/12/2020 08:19	08/12/2020 09:02	0,71	2	1,42	CHI
20201237483	FORMOSA	FA21229944	ITUIQUIRA	08/12/2020 08:20	08/12/2020 11:50	08/12/2020 08:20	08/12/2020 11:50	3,50	1	3,50	CHI
20201237484	APORE	AE21392401	ITAJA S2	08/12/2020 08:20	08/12/2020 16:19	08/12/2020 08:20	08/12/2020 16:19	7,98	1	7,98	CHI
20201237487	ITAPACI	IW12281203	ITAPACI	08/12/2020 08:20	08/12/2020 10:33	08/12/2020 08:20	08/12/2020 10:33	2,20	2	4,41	CHI
20201237487	GUARINOS	IW12281203	ITAPACI	08/12/2020 08:20	08/12/2020 10:33	08/12/2020 08:20	08/12/2020 10:33	2,20	5	11,02	CHI
20201237489	PIRES DO RIO	PR21000055	PIRES DO RIO S1	08/12/2020 08:20	08/12/2020 11:24	08/12/2020 08:20	08/12/2020 11:24	3,05	1	3,05	CHI
20201237491	FORMOSA	FA21017449	ITUIQUIRA	08/12/2020 08:21	08/12/2020 10:12	08/12/2020 08:21	08/12/2020 10:12	1,85	1	1,85	CHI
20201237498	TRINDADE	10006460125	TRINDADE	08/12/2020 08:21	08/12/2020 13:00	08/12/2020 08:21	08/12/2020 13:00	4,64	1	4,64	CHI
20201237504	MONTES CLAROS DE GOIAS	DI12123918	ARENOPOLIS	08/12/2020 08:22	08/12/2020 16:18	08/12/2020 08:22	08/12/2020 16:18	7,92	1	7,92	CHI
20201237504	DIORAMA	DI12123918	ARENOPOLIS	08/12/2020 08:22	08/12/2020 16:18	08/12/2020 08:22	08/12/2020 16:18	7,92	4	31,67	CHI
20201237507	LUZIANIA	LZ21290821	PAMPLONA	08/12/2020 08:23	08/12/2020 11:26	08/12/2020 08:23	08/12/2020 11:26	3,05	1	3,05	CHI
20201237889	MATRINCHA	MP12098851	MATRINCHA	08/12/2020 08:23	08/12/2020 13:51	08/12/2020 08:23	08/12/2020 13:51	5,47	82	448,24	CHI
20201237514	CACHOEIRA ALTA	CA12279746	CACHOEIRA ALTA	08/12/2020 08:24	08/12/2020 09:51	08/12/2020 08:24	08/12/2020 09:51	1,45	2	2,90	CHI
20201237515	PANAMA	PX21263936	GOIATUBA S1	08/12/2020 08:24	08/12/2020 10:38	08/12/2020 08:24	08/12/2020 10:38	2,23	1	2,23	CHI
20201237523	CAIAPONIA	CP12207924	CAIAPONIA	08/12/2020 08:25	08/12/2020 21:39	08/12/2020 08:25	08/12/2020 21:39	13,23	2	26,46	CHI
20201237524	APORE	AE21154146	ITAJA S1	08/12/2020 08:25	08/12/2020 18:12	08/12/2020 08:25	08/12/2020 18:12	9,77	1	9,77	CHI
20201238117	COCALZINHO DE GOIAS	ZN12302491	COCALZINHO	08/12/2020 08:25	09/12/2020 02:33	08/12/2020 08:25	09/12/2020 02:33	18,13	17	308,19	CHI
20201237536	SANTO ANTONIO DO DESCOBERTO	SN21078134	MARAJOARA	08/12/2020 08:27	08/12/2020 10:39	08/12/2020 08:27	08/12/2020 10:39	2,18	2	4,37	CHI
20201237537	SANTO ANTONIO DO DESCOBERTO	SN21082874	MARAJOARA	08/12/2020 08:28	08/12/2020 12:13	08/12/2020 08:28	08/12/2020 12:13	3,75	1	3,75	CHI
20201239084	AMARALINA	LC12168861	MARA ROSA	08/12/2020 08:28	08/12/2020 14:10	08/12/2020 08:28	08/12/2020 14:10	5,69	4	22,78	CHI
20201237551	MONTE ALEGRE DE GOIAS	MA12405108	SAO DOMINGOS	08/12/2020 08:29	08/12/2020 14:28	08/12/2020 08:29	08/12/2020 14:28	5,97	528	3150,69	CHI
20201237551	CAVALCANTE	MA12405108	SAO DOMINGOS	08/12/2020 08:29	08/12/2020 14:28	08/12/2020 08:29	08/12/2020 14:28	5,97	245	1461,97	CHI
20201237551	NOVA ROMA	MA12405108	SAO DOMINGOS	08/12/2020 08:29	08/12/2020 14:28	08/12/2020 08:29	08/12/2020 14:28	5,97	57	340,13	CHI
20201237555	AMARALINA	LC12216163	MARA ROSA	08/12/2020 08:30	08/12/2020 18:41	08/12/2020 08:30	08/12/2020 18:41	10,18	5	50,88	CHI
20201237557	GOIANIRA	GR11275475	MEIA PONTE	08/12/2020 08:30	08/12/2020 19:08	08/12/2020 18:13	08/12/2020 19:08	0,92	88	81,18	CHI
20201237562	RUBIATABA	RB12003306	RUBIATABA	08/12/2020 08:31	08/12/2020 12:14	08/12/2020 08:31	08/12/2020 12:14	3,72	3	11,15	CHI
20201237566	ITAPACI	IW21236862	ITAPACI	08/12/2020 08:31	08/12/2020 09:51	08/12/2020 08:31	08/12/2020 09:51	1,32	1	1,32	CHI
20201237960	PEROLANDIA	DP12133585	JATAI S1	08/12/2020 08:31	08/12/2020 12:37	08/12/2020 08:31	08/12/2020 12:37	4,09	6	24,56	CHI
20201238024	BOM JARDIM DE GOIAS	BM12004828	BOM JARDIM	08/12/2020 08:31	08/12/2020 10:29	08/12/2020 08:31	08/12/2020 10:29	1,96	13	25,53	CHI
20201237610	SANTO ANTONIO DE GOIAS	BW12291579	NEROPOLIS S1	08/12/2020 08:32	08/12/2020 11:40	08/12/2020 08:32	08/12/2020 11:40	3,13	2	6,25	CHI

20201237610	GOIANIRA	BW12291579	NEROPOLIS S1	08/12/2020 08:32	08/12/2020 11:40	08/12/2020 08:32	08/12/2020 11:40	3,13	3	9,38	CHI
20201237571	FORMOSA	FA21106853	SAO JOAO D ALIANCA	08/12/2020 08:33	08/12/2020 10:18	08/12/2020 08:33	08/12/2020 10:18	1,75	1	1,75	CHI
20201237573	OUIDOR	2180003001	CATALAO S1	08/12/2020 08:34	08/12/2020 09:34	08/12/2020 08:34	08/12/2020 09:34	0,99	1	0,99	CHI
20201239370	MINACU	IH12253865RE	MINACU	08/12/2020 08:35	08/12/2020 16:47	08/12/2020 08:35	08/12/2020 16:47	8,20	248	2033,60	CHI
20201239370	TROMBAS	IH12253865RE	MINACU	08/12/2020 08:35	08/12/2020 16:47	08/12/2020 08:35	08/12/2020 16:47	8,20	6	49,20	CHI
20201237595	MINACU	IH21192279	MINACU	08/12/2020 08:36	08/12/2020 17:25	08/12/2020 08:36	08/12/2020 17:25	8,81	2	17,62	CHI
20201237597	ARUANA	2380020493	ARUANA	08/12/2020 08:36	08/12/2020 14:38	08/12/2020 08:36	08/12/2020 14:38	6,02	1	6,02	CHI
20201237598	APARECIDA DE GOIANIA	AP11004607	ANHANGUERA	08/12/2020 08:36	08/12/2020 11:36	08/12/2020 10:40	08/12/2020 11:36	0,92	20	18,37	CHI
20201238190	PONTALINA	PK12263485LD	PONTALINA	08/12/2020 08:36	08/12/2020 21:43	08/12/2020 08:36	08/12/2020 21:43	13,11	4	52,45	CHI
20201238190	PONTALINA	PK12263485LD	PONTALINA	08/12/2020 08:36	08/12/2020 21:43	08/12/2020 19:19	08/12/2020 21:43	2,40	6	14,41	CHI
20201238231	APORE	AE12209684LD	ITAJA S1	08/12/2020 08:36	08/12/2020 22:53	08/12/2020 08:36	08/12/2020 22:53	14,28	11	157,08	CHI
20201239417	SANCLERLANDIA	SC12388895	FIRMINOPOLIS S2	08/12/2020 08:37	08/12/2020 17:29	08/12/2020 08:37	08/12/2020 17:29	8,85	3	26,56	CHI
20201237728	FORMOSA	FA12218278	SAO JOAO D ALIANCA	08/12/2020 08:38	08/12/2020 15:58	08/12/2020 08:38	08/12/2020 15:58	7,32	3	21,97	CHI
20201237613	QUIRINOPOLIS	80062532	QUIRINOPOLIS	08/12/2020 08:39	08/12/2020 21:29	08/12/2020 08:39	08/12/2020 21:29	12,82	1	12,82	CHI
20201237614	GOIANESIA	GE21317831	GOIANESIA S2	08/12/2020 08:40	08/12/2020 18:34	08/12/2020 08:40	08/12/2020 18:34	9,90	2	19,79	CHI
20201237617	ABADIANA	350002733	ANAPOLIS UNIVERSITARIO S1	08/12/2020 08:40	08/12/2020 12:07	08/12/2020 08:40	08/12/2020 12:07	3,44	1	3,44	CHI
20201237618	ALEXANIA	480040631	ALEXANIA	08/12/2020 08:40	08/12/2020 10:15	08/12/2020 08:40	08/12/2020 10:15	1,58	1	1,58	CHI
20201237620	ALTO HORIZONTE	AJ21143592	MARA ROSA	08/12/2020 08:40	08/12/2020 16:09	08/12/2020 08:40	08/12/2020 16:09	7,47	1	7,47	CHI
20201237623	FORMOSA	610112480	ITUIQUIRA	08/12/2020 08:40	08/12/2020 12:54	08/12/2020 08:40	08/12/2020 12:54	4,22	1	4,22	CHI
20201237635	ITAPACI	IW21094097	ITAPACI	08/12/2020 08:42	08/12/2020 12:14	08/12/2020 08:42	08/12/2020 12:14	3,53	2	7,05	CHI
20201237639	MINEIROS	MY12166286RE	CHAPADAO DO CEU	08/12/2020 08:43	08/12/2020 12:45	08/12/2020 08:43	08/12/2020 12:45	4,03	5	20,13	CHI
20201237639	SERRANOPOLIS	MY12166286RE	CHAPADAO DO CEU	08/12/2020 08:43	08/12/2020 12:45	08/12/2020 08:43	08/12/2020 12:45	4,03	10	40,26	CHI
20201238063	NOVA ROMA	ND12392238	IACIARA S2	08/12/2020 08:43	08/12/2020 11:04	08/12/2020 08:43	08/12/2020 11:04	2,34	235	548,92	CHI
20201237649	NEROPOLIS	NR11104451	NEROPOLIS S2	08/12/2020 08:44	08/12/2020 10:04	08/12/2020 08:44	08/12/2020 10:04	1,32	18	23,75	CHI
20201237670	CRISTALINA	KR12163713	CRISTALINA S2	08/12/2020 08:44	08/12/2020 10:05	08/12/2020 08:44	08/12/2020 10:05	1,35	4	5,40	CHI
20201237654	SAO MIGUEL DO PASSA QUATRO	SV12099203	BELA VISTA S2	08/12/2020 08:45	08/12/2020 11:33	08/12/2020 08:45	08/12/2020 11:33	2,79	1	2,79	CHI
20201237654	SILVANIA	SV12099203	BELA VISTA S2	08/12/2020 08:45	08/12/2020 11:33	08/12/2020 08:45	08/12/2020 11:33	2,79	1	2,79	CHI
20201237657	MORRINHOS	150124429	MORRINHOS	08/12/2020 08:46	08/12/2020 10:22	08/12/2020 08:46	08/12/2020 10:22	1,60	1	1,60	CHI
20201237674	JATAI	JT21360632	CABRIUVA S2	08/12/2020 08:49	08/12/2020 15:33	08/12/2020 08:49	08/12/2020 15:33	6,73	1	6,73	CHI
20201237680	MINEIROS	MY21195603	PARQUE DAS EMAS	08/12/2020 08:49	08/12/2020 15:20	08/12/2020 08:49	08/12/2020 15:20	6,51	1	6,51	CHI
20201237909	MOZARLANDIA	MZ12055628	MOZARLANDIA	08/12/2020 08:49	08/12/2020 12:05	08/12/2020 08:49	08/12/2020 12:05	3,26	40	130,36	CHI
20201237909	CRIXAS	MZ12055628	MOZARLANDIA	08/12/2020 08:49	08/12/2020 12:05	08/12/2020 08:49	08/12/2020 12:05	3,26	26	84,73	CHI
20201237687	CORUMBAIBA	CI21000482	VILA CORUMBA	08/12/2020 08:50	08/12/2020 13:34	08/12/2020 08:50	08/12/2020 13:34	4,74	1	4,74	CHI
20201237691	MONTIVIDIU DO NORTE	MX12270942	PORANGATU	08/12/2020 08:50	08/12/2020 12:08	08/12/2020 08:50	08/12/2020 12:08	3,29	50	164,47	CHI
20201237693	RIO VERDE	10010984117	RIO VERDE S1	08/12/2020 08:50	08/12/2020 14:07	08/12/2020 08:50	08/12/2020 14:07	5,27	1	5,27	CHI
20201237836	PIRENOPOLIS	GE12185195	GOIANESIA S1	08/12/2020 08:50	08/12/2020 21:04	08/12/2020 08:50	08/12/2020 21:04	12,22	29	354,45	CHI
20201241600	INACIOLANDIA	CD12000116	CACHOEIRA DOURADA	08/12/2020 08:50	08/12/2020 18:58	08/12/2020 08:50	08/12/2020 18:58	10,13	13	131,65	CHI
20201237696	FLORES DE GOIAS	FB21164520	IACIARA S2	08/12/2020 08:51	08/12/2020 17:11	08/12/2020 08:51	08/12/2020 17:11	8,32	1	8,32	CHI
20201237697	RIO VERDE	630520392	RIO VERDE S1	08/12/2020 08:51	08/12/2020 10:57	08/12/2020 08:51	08/12/2020 10:57	2,09	1	2,09	CHI
20201237698	SANTO ANTONIO DO DESCOBERTO	SN12330527	MARAJOARA	08/12/2020 08:52	08/12/2020 14:29	08/12/2020 08:52	08/12/2020 14:29	5,62	16	89,87	CHI
20201237702	ANAPOLIS	AN12003541	JUNDIAI S1	08/12/2020 08:52	08/12/2020 11:31	08/12/2020 08:52	08/12/2020 11:31	2,64	388	1025,83	CHI
20201237712	CRISTALINA	KR12270342	CRISTALINA S2	08/12/2020 08:53	08/12/2020 15:21	08/12/2020 08:53	08/12/2020 15:21	6,45	1	6,45	CHI
20201237713	AMARALINA	MQ12050047	MARA ROSA	08/12/2020 08:53	08/12/2020 11:36	08/12/2020 08:53	08/12/2020 11:36	2,70	233	629,81	CHI
20201237717	GOIATUBA	GT12318190LD	BOM JESUS DE GOIAS	08/12/2020 08:55	08/12/2020 16:25	08/12/2020 08:55	08/12/2020 16:25	7,50	7	52,50	CHI
20201237723	SANTA TEREZA DE GOIAS	TB12170075	PORANGATU	08/12/2020 08:55	08/12/2020 16:25	08/12/2020 08:55	08/12/2020 16:25	7,49	3	22,46	CHI
20201237724	PALESTINA DE GOIAS	PY21071503	PALESTINA	08/12/2020 08:56	08/12/2020 16:58	08/12/2020 08:56	08/12/2020 16:58	8,03	1	8,03	CHI
20201237726	APARECIDA DE GOIANIA	200390934	INDEPENDENCIA S1	08/12/2020 08:56	08/12/2020 10:06	08/12/2020 08:56	08/12/2020 10:06	1,16	1	1,16	CHI
20201237730	APARECIDA DE GOIANIA	10016153624	ANHANGUERA	08/12/2020 08:56	08/12/2020 10:43	08/12/2020 08:56	08/12/2020 10:43	1,77	1	1,77	CHI
20201239259	BOM JESUS DE GOIAS	BJ12033099	BOM JESUS DE GOIAS	08/12/2020 08:56	08/12/2020 14:19	08/12/2020 08:56	08/12/2020 14:19	5,38	5	26,90	CHI
20201239259	QUIRINOPOLIS	BJ12033099	BOM JESUS DE GOIAS	08/12/2020 08:56	08/12/2020 14:19	08/12/2020 08:56	08/12/2020 14:19	5,38	4	21,52	CHI
20201237733	BELA VISTA DE GOIAS	BV21031699	BELA VISTA S1	08/12/2020 08:57	08/12/2020 09:51	08/12/2020 08:57	08/12/2020 09:51	0,90	1	0,90	CHI

20201237735	GOIANIRA	IN21188620	INHUMAS S2	08/12/2020 08:57	08/12/2020 11:03	08/12/2020 08:57	08/12/2020 11:03	2,10	1	2,10	CHI
20201237736	GOIANIA	14506490	CAMPINAS S3	08/12/2020 08:57	08/12/2020 10:25	08/12/2020 08:57	08/12/2020 10:25	1,46	1	1,46	CHI
20201237737	HIDROLANDIA	HD31097689	GUAPO S2	08/12/2020 08:57	08/12/2020 13:25	08/12/2020 08:57	08/12/2020 13:25	4,46	2	8,92	CHI
20201237784	FORMOSA	FA12397206	SAO JOAO D ALIANCA	08/12/2020 08:57	08/12/2020 11:32	08/12/2020 08:57	08/12/2020 11:32	2,58	15	38,75	CHI
20201237850	ACREUNA	EU12207112	ACREUNA	08/12/2020 08:57	08/12/2020 11:03	08/12/2020 08:57	08/12/2020 11:03	2,10	6	12,57	CHI
20201237741	RIO VERDE	10032063502	CABRIUVA S1	08/12/2020 08:58	08/12/2020 19:35	08/12/2020 08:58	08/12/2020 19:35	10,62	1	10,62	CHI
20201237746	CUMARI	CY21071552	CATALAO S1	08/12/2020 08:59	08/12/2020 10:44	08/12/2020 08:59	08/12/2020 10:44	1,75	1	1,75	CHI
20201237750	MAURILANDIA	ML21303572	RIO DOS BOIS	08/12/2020 08:59	09/12/2020 00:18	08/12/2020 08:59	09/12/2020 00:18	15,31	1	15,31	CHI
20201238247	MORRINHOS	GT12188828	GOIATUBA S2	08/12/2020 09:01	08/12/2020 11:36	08/12/2020 09:01	08/12/2020 11:36	2,58	8	20,64	CHI
20201237761	GOIANIA	GN11130314	REAL S2	08/12/2020 09:02	08/12/2020 12:14	08/12/2020 09:48	08/12/2020 12:14	2,43	51	124,10	CHI
20201237773	SAO MIGUEL DO ARAGUAIA	SM12309562	SAO MIGUEL DO ARAGUAIA	08/12/2020 09:03	08/12/2020 16:57	08/12/2020 09:03	08/12/2020 16:57	7,90	2	15,79	CHI
20201238603	FORMOSA	FA12207282	ITUIQUIRA	08/12/2020 09:03	08/12/2020 18:47	08/12/2020 09:03	08/12/2020 18:47	9,73	14	136,20	CHI
20201237777	MONTES CLAROS DE GOIAS	ME21004037	IPORA	08/12/2020 09:04	08/12/2020 10:38	08/12/2020 09:04	08/12/2020 10:38	1,58	1	1,58	CHI
20201237779	AGUAS LINDAS DE GOIAS	4830185741	AGUAS LINDAS DE GOIAS S1	08/12/2020 09:04	08/12/2020 10:52	08/12/2020 09:04	08/12/2020 10:52	1,79	1	1,79	CHI
20201238165	PIRACANJUBA	PJ21316609	BELA VISTA S1	08/12/2020 09:04	08/12/2020 15:54	08/12/2020 09:04	08/12/2020 15:54	6,83	1	6,83	CHI
20201239489	ITAPACI	IW12032522	RUBIATABA	08/12/2020 09:04	09/12/2020 14:03	08/12/2020 09:04	08/12/2020 20:28	11,40	11	125,41	CHI
20201239489	CRIXAS	IW12032522	RUBIATABA	08/12/2020 09:04	09/12/2020 14:03	08/12/2020 09:04	08/12/2020 20:28	11,40	12	136,81	CHI
20201239489	GUARINOS	IW12032522	RUBIATABA	08/12/2020 09:04	09/12/2020 14:03	08/12/2020 09:04	08/12/2020 21:46	12,69	5	63,46	CHI
20201239489	ITAPACI	IW12032522	RUBIATABA	08/12/2020 09:04	09/12/2020 14:03	08/12/2020 09:04	08/12/2020 21:46	12,69	14	177,68	CHI
20201239489	CRIXAS	IW12032522	RUBIATABA	08/12/2020 09:04	09/12/2020 14:03	08/12/2020 09:04	08/12/2020 21:46	12,69	1	12,69	CHI
20201239489	GUARINOS	IW12032522	RUBIATABA	08/12/2020 09:04	09/12/2020 14:03	08/12/2020 09:04	09/12/2020 14:03	28,99	6	173,94	CHI
20201239489	ITAPACI	IW12032522	RUBIATABA	08/12/2020 09:04	09/12/2020 14:03	08/12/2020 09:04	09/12/2020 14:03	28,99	7	202,93	CHI
20201237791	RIO VERDE	RV21034593	RIO VERDE S1	08/12/2020 09:05	08/12/2020 15:00	08/12/2020 09:05	08/12/2020 15:00	5,91	2	11,82	CHI
20201242224	MORRINHOS	MR12395643	GOIATUBA S1	08/12/2020 09:05	08/12/2020 19:39	08/12/2020 09:05	08/12/2020 19:39	10,56	161	1699,98	CHI
20201237802	CEZARINA	CZ21220929	CEZARINA	08/12/2020 09:06	08/12/2020 10:18	08/12/2020 09:06	08/12/2020 10:18	1,19	2	2,38	CHI
20201237816	GUAPO	710020600	GUAPO S1	08/12/2020 09:08	08/12/2020 16:13	08/12/2020 09:08	08/12/2020 16:13	7,08	1	7,08	CHI
20201237820	ITABERAI	10004056572	ITABERAI S2	08/12/2020 09:08	08/12/2020 10:55	08/12/2020 09:08	08/12/2020 10:55	1,78	1	1,78	CHI
20201237821	CRISTALINA	KR21201197	CRISTALINA S1	08/12/2020 09:08	08/12/2020 11:39	08/12/2020 09:08	08/12/2020 11:39	2,51	1	2,51	CHI
20201237823	MORRINHOS	150112890	MORRINHOS	08/12/2020 09:09	08/12/2020 12:03	08/12/2020 09:09	08/12/2020 12:03	2,90	1	2,90	CHI
20201237824	ITUMBIARA	IT21097342	ITUMBIARA VELHA S1	08/12/2020 09:09	08/12/2020 11:15	08/12/2020 09:09	08/12/2020 11:15	2,10	1	2,10	CHI
20201237825	SANTA HELENA DE GOIAS	SH21248970	SANTA HELENA S1	08/12/2020 09:09	08/12/2020 20:34	08/12/2020 09:09	08/12/2020 20:34	11,41	1	11,41	CHI
20201237837	ITABERAI	IB31198994	ITABERAI S2	08/12/2020 09:10	08/12/2020 13:42	08/12/2020 09:10	08/12/2020 13:42	4,52	1	4,52	CHI
20201237867	CALDAS NOVAS	CN21060282	RIO QUENTE	08/12/2020 09:11	08/12/2020 12:47	08/12/2020 09:11	08/12/2020 12:47	3,60	1	3,60	CHI
20201237845	ABADIA DE GOIAS	GN21062125	CARAJAS S1	08/12/2020 09:12	08/12/2020 15:24	08/12/2020 09:12	08/12/2020 15:24	6,20	2	12,40	CHI
20201237846	QUIRINOPOLIS	QI21014938	QUIRINOPOLIS	08/12/2020 09:12	08/12/2020 15:41	08/12/2020 09:12	08/12/2020 15:41	6,48	1	6,48	CHI
20201237849	GOIANIA	11533705	CAMPINAS S1	08/12/2020 09:12	08/12/2020 12:59	08/12/2020 09:12	08/12/2020 12:59	3,78	1	3,78	CHI
20201237851	ABADIANIA	AA21295617	DAIA S2	08/12/2020 09:12	08/12/2020 12:45	08/12/2020 09:12	08/12/2020 12:45	3,54	1	3,54	CHI
20201237854	JANDAIA	JD21301323	ACREUNA	08/12/2020 09:13	08/12/2020 13:17	08/12/2020 09:13	08/12/2020 13:17	4,06	1	4,06	CHI
20201237858	MARA ROSA	MQ21182372	MARA ROSA	08/12/2020 09:14	08/12/2020 23:13	08/12/2020 09:14	08/12/2020 22:41	13,45	1	13,45	CHI
20201237858	MARA ROSA	MQ12291116LD	MARA ROSA	08/12/2020 09:14	08/12/2020 23:13	08/12/2020 19:53	08/12/2020 23:13	3,33	16	53,22	CHI
20201237861	GOIANESIA	GE21000231	GOIANESIA S2	08/12/2020 09:14	08/12/2020 17:26	08/12/2020 09:14	08/12/2020 17:26	8,19	1	8,19	CHI
20201240742	SAO LUIZ DO NORTE	SZ12066095	ITAPACI	08/12/2020 09:14	08/12/2020 16:56	08/12/2020 09:14	08/12/2020 16:56	7,69	6	46,11	CHI
20201237866	MINEIROS	MY12303820	PARQUE DAS EMAS	08/12/2020 09:16	09/12/2020 10:58	08/12/2020 09:16	09/12/2020 10:58	25,70	29	745,29	CHI
20201237866	SANTA RITA DO ARAGUAIA	MY12303820	PARQUE DAS EMAS	08/12/2020 09:16	09/12/2020 10:58	08/12/2020 09:16	09/12/2020 10:58	25,70	2	51,40	CHI
20201237957	MONTIVIDIU	MV12267741	MONTIVIDIU T	08/12/2020 09:16	08/12/2020 10:28	08/12/2020 09:16	08/12/2020 10:28	1,19	2	2,38	CHI
20201237873	HIDROLANDIA	HD11000036	CEPAIGO S2	08/12/2020 09:17	08/12/2020 16:50	08/12/2020 15:17	08/12/2020 16:50	1,55	222	343,54	CHI
20201237877	SERRANOPOLIS	SX12260517	JATAI S1	08/12/2020 09:17	08/12/2020 12:02	08/12/2020 09:17	08/12/2020 12:02	2,74	2	5,47	CHI
20201237884	ITABERAI	50064885	ITABERAI S2	08/12/2020 09:18	08/12/2020 10:23	08/12/2020 09:18	08/12/2020 10:23	1,07	1	1,07	CHI
20201237890	FLORES DE GOIAS	FB12287910	IACIARA S2	08/12/2020 09:19	08/12/2020 16:01	08/12/2020 09:19	08/12/2020 16:01	6,69	4	26,77	CHI
20201237896	FAINA	FC12158726	GOIAS	08/12/2020 09:20	08/12/2020 18:20	08/12/2020 09:20	08/12/2020 18:20	8,99	4	35,97	CHI
20201237897	LUZIANIA	120158073	RIO VERMELHO	08/12/2020 09:20	08/12/2020 11:33	08/12/2020 09:20	08/12/2020 11:33	2,21	1	2,21	CHI

20201243459	JARAGUA	JA12374473	JARAGUA	08/12/2020 09:20	08/12/2020 22:22	08/12/2020 18:17	08/12/2020 22:22	4,08	259	1056,79	CHI
202012117920	JARAGUA	JA21114606	JARAGUA	08/12/2020 09:20	08/12/2020 22:22	08/12/2020 09:20	08/12/2020 22:22	13,03	1	13,03	CHI
202012179365	DOVERLANDIA	DV21188465	PARQUE DAS EMAS	08/12/2020 09:20	11/12/2020 18:43	08/12/2020 09:20	11/12/2020 18:43	81,39	1	81,39	CHI
20201237903	ARUANA	2380020377	ARUANA	08/12/2020 09:21	08/12/2020 16:54	08/12/2020 09:21	08/12/2020 16:54	7,54	1	7,54	CHI
20201237921	TRINDADE	TR31057454	TRINDADE	08/12/2020 09:22	08/12/2020 11:57	08/12/2020 09:22	08/12/2020 11:57	2,58	2	5,16	CHI
20201237923	MATRINCHA	MP21299773	MATRINCHA	08/12/2020 09:22	08/12/2020 10:46	08/12/2020 09:22	08/12/2020 10:46	1,39	1	1,39	CHI
20201237926	NIQUELANDIA	NQ21366188	SAO JOAO D ALIANCA	08/12/2020 09:22	08/12/2020 11:21	08/12/2020 09:22	08/12/2020 11:21	1,97	1	1,97	CHI
20201238041	CACHOEIRA ALTA	PC12000076	CACHOEIRA ALTA	08/12/2020 09:22	08/12/2020 13:42	08/12/2020 09:22	08/12/2020 13:42	4,33	8	34,60	CHI
20201238041	PARANAIGUARA	PC12000076	CACHOEIRA ALTA	08/12/2020 09:22	08/12/2020 13:42	08/12/2020 09:22	08/12/2020 13:42	4,33	5	21,63	CHI
20201237930	TRINDADE	40148245	TRINDADE	08/12/2020 09:23	08/12/2020 11:07	08/12/2020 09:23	08/12/2020 11:07	1,73	1	1,73	CHI
20201238030	FAINA	FC12057965	GOIAS	08/12/2020 09:24	08/12/2020 12:49	08/12/2020 09:24	08/12/2020 12:49	3,41	6	20,48	CHI
20201237942	ISRAELANDIA	IS21079586	IPORA	08/12/2020 09:25	08/12/2020 12:09	08/12/2020 09:25	08/12/2020 12:09	2,73	1	2,73	CHI
20201237943	MINEIROS	MY21325792	PARQUE DAS EMAS	08/12/2020 09:25	08/12/2020 12:54	08/12/2020 09:25	08/12/2020 12:54	3,48	1	3,48	CHI
20201237950	RIO VERDE	RV12338542	CABRIUVA S2	08/12/2020 09:26	08/12/2020 13:01	08/12/2020 09:26	08/12/2020 13:01	3,57	3	10,72	CHI
20201237952	ITUMBIARA	IT12000251	ITUMBIARA NOVA	08/12/2020 09:26	08/12/2020 11:40	08/12/2020 09:26	08/12/2020 11:40	2,22	6	13,31	CHI
20201238021	GOIATUBA	GT12273783	GOIATUBA S2	08/12/2020 09:27	08/12/2020 14:23	08/12/2020 09:27	08/12/2020 14:23	4,93	28	138,00	CHI
20201238021	MORRINHOS	GT12273783	GOIATUBA S2	08/12/2020 09:27	08/12/2020 14:23	08/12/2020 09:27	08/12/2020 14:23	4,93	3	14,79	CHI
20201237965	FORMOSA	FA11269952	ITUIQUIRA	08/12/2020 09:28	08/12/2020 13:59	08/12/2020 09:28	08/12/2020 13:59	4,50	0	0,00	CHI
20201238817	FORMOSO	FO12145300	PORANGATU	08/12/2020 09:28	08/12/2020 16:45	08/12/2020 09:28	08/12/2020 16:45	7,28	11	80,06	CHI
20201237966	VIANOPOLIS	VN21159665	VIANOPOLIS	08/12/2020 09:29	08/12/2020 11:24	08/12/2020 09:29	08/12/2020 11:24	1,91	1	1,91	CHI
20201237967	CRISTIANOPOLIS	CF12344706	CRISTIANOPOLIS	08/12/2020 09:29	08/12/2020 11:28	08/12/2020 09:29	08/12/2020 11:28	1,98	19	37,59	CHI
20201237970	IPAMERI	IP21233848	IPAMERI	08/12/2020 09:30	08/12/2020 19:18	08/12/2020 09:30	08/12/2020 19:18	9,80	1	9,80	CHI
20201237978	QUIRINOPOLIS	QI11000045	QUIRINOPOLIS	08/12/2020 09:31	08/12/2020 15:58	08/12/2020 09:31	08/12/2020 15:58	6,45	21	135,43	CHI
20201237981	BELA VISTA DE GOIAS	BV21034834	BELA VISTA S1	08/12/2020 09:31	08/12/2020 11:20	08/12/2020 09:31	08/12/2020 11:20	1,81	2	3,62	CHI
20201237995	POSSE	PS12375542	IACIARA S2	08/12/2020 09:33	08/12/2020 13:59	08/12/2020 09:33	08/12/2020 13:59	4,42	4	17,69	CHI
20201238000	PIRENOPOLIS	PV21000011	CORUMBA	08/12/2020 09:34	08/12/2020 17:45	08/12/2020 09:34	08/12/2020 17:45	8,18	1	8,18	CHI
20201238001	GOIANIA	17074976	GOIANIA LESTE S3	08/12/2020 09:34	08/12/2020 10:08	08/12/2020 09:34	08/12/2020 10:08	0,56	1	0,56	CHI
20201238025	INDIARA	IY12233476	EDEIA	08/12/2020 09:34	08/12/2020 14:15	08/12/2020 09:34	08/12/2020 14:15	4,68	39	182,47	CHI
20201238283	ITABERAI	IB12106151LD	ITABERAI S1	08/12/2020 09:35	08/12/2020 12:34	08/12/2020 09:35	08/12/2020 12:34	2,98	27	80,37	CHI
20201238283	GOIAS	IB12106151LD	ITABERAI S1	08/12/2020 09:35	08/12/2020 12:34	08/12/2020 09:35	08/12/2020 12:34	2,98	2	5,95	CHI
20201238008	ITAPURANGA	170007406	ITAPURANGA	08/12/2020 09:36	08/12/2020 14:35	08/12/2020 09:36	08/12/2020 14:35	4,98	1	4,98	CHI
20201238013	SANTA CRUZ DE GOIAS	BC21159589	PIRES DO RIO S2	08/12/2020 09:36	08/12/2020 13:11	08/12/2020 09:36	08/12/2020 13:11	3,57	1	3,57	CHI
20201238018	CALDAS NOVAS	CN12246589	SERRA DE CALDAS	08/12/2020 09:37	08/12/2020 11:00	08/12/2020 09:37	08/12/2020 11:00	1,38	58	79,85	CHI
20201238023	CACHOEIRA DOURADA	10010215555	CACHOEIRA DOURADA	08/12/2020 09:38	09/12/2020 10:03	08/12/2020 09:38	09/12/2020 10:03	24,41	1	24,41	CHI
20201238034	ALTO PARAISO DE GOIAS	BF12274597	FLORES DE GOIAS	08/12/2020 09:39	08/12/2020 17:39	08/12/2020 09:39	08/12/2020 17:39	7,99	1	7,99	CHI
20201238037	PORANGATU	PO12360153	PORANGATU	08/12/2020 09:39	08/12/2020 11:01	08/12/2020 09:39	08/12/2020 11:01	1,36	3	4,07	CHI
20201238052	PETROLINA DE GOIAS	PG21337601	PETROLINA	08/12/2020 09:41	09/12/2020 13:45	08/12/2020 09:41	09/12/2020 13:45	28,07	1	28,07	CHI
20201238056	PONTALINA	PK21080043	PONTALINA	08/12/2020 09:41	08/12/2020 10:59	08/12/2020 09:41	08/12/2020 10:59	1,29	1	1,29	CHI
20201239391	SAO JOAO D ALIANCA	JL12218373	SAO JOAO D ALIANCA	08/12/2020 09:41	08/12/2020 14:26	08/12/2020 09:41	08/12/2020 14:26	4,74	137	649,34	CHI
20201239622	SAO JOAO D ALIANCA	JL21312655	SAO JOAO D ALIANCA	08/12/2020 09:41	10/12/2020 18:48	08/12/2020 09:41	10/12/2020 18:48	57,10	1	57,10	CHI
20201238068	LUZIANIA	LZ21261361	RIO VERMELHO	08/12/2020 09:42	08/12/2020 11:45	08/12/2020 09:42	08/12/2020 11:45	2,04	1	2,04	CHI
20201238269	RIO VERDE	RV12098595	RIO VERDE S1	08/12/2020 09:42	09/12/2020 02:52	08/12/2020 09:42	09/12/2020 02:52	17,16	16	274,58	CHI
20201238269	RIO VERDE	RV12098595	RIO VERDE S1	08/12/2020 09:42	09/12/2020 02:52	09/12/2020 00:24	09/12/2020 02:52	2,46	1	2,46	CHI
20201238078	GOIANIA	15790691	CAMPINAS S3	08/12/2020 09:44	08/12/2020 12:29	08/12/2020 09:44	08/12/2020 12:29	2,73	1	2,73	CHI
20201238079	MORRINHOS	MR12264053	MORRINHOS	08/12/2020 09:44	08/12/2020 22:52	08/12/2020 09:44	08/12/2020 22:52	13,12	3	39,36	CHI
20201238079	MORRINHOS	MR12264053	MORRINHOS	08/12/2020 09:44	08/12/2020 22:52	08/12/2020 19:30	08/12/2020 22:52	3,37	6	20,19	CHI
20201238081	BELA VISTA DE GOIAS	BV21379537	BELA VISTA S1	08/12/2020 09:45	08/12/2020 12:15	08/12/2020 09:45	08/12/2020 12:15	2,50	1	2,50	CHI
20201238088	CRISTALINA	KR12313482	CRISTALINA S2	08/12/2020 09:46	08/12/2020 18:04	08/12/2020 09:46	08/12/2020 18:04	8,29	3	24,88	CHI
20201238092	DIORAMA	DI21087044	ARENOPOLIS	08/12/2020 09:46	08/12/2020 18:20	08/12/2020 09:46	08/12/2020 18:20	8,55	1	8,55	CHI
20201238103	GOUVELANDIA	GB21261020	QUIRINOPOLIS	08/12/2020 09:48	09/12/2020 00:53	08/12/2020 09:48	09/12/2020 00:53	15,07	1	15,07	CHI
20201238104	CABECEIRAS	CW21049277	ITUIQUIRA	08/12/2020 09:49	08/12/2020 10:35	08/12/2020 09:49	08/12/2020 10:35	0,77	1	0,77	CHI

20201238109	COCALZINHO DE GOIAS	10004308741	AGUAS LINDAS DE GOIAS S2	08/12/2020 09:49	08/12/2020 14:36	08/12/2020 09:49	08/12/2020 14:36	4,77	1	4,77	CHI
20201238111	AGUAS LINDAS DE GOIAS	4830109635	AGUAS LINDAS DE GOIAS S1	08/12/2020 09:50	08/12/2020 11:17	08/12/2020 09:50	08/12/2020 11:17	1,44	1	1,44	CHI
20201238112	QUIRINOPOLIS	QI21305699	QUIRINOPOLIS	08/12/2020 09:50	08/12/2020 15:20	08/12/2020 09:50	08/12/2020 15:20	5,49	1	5,49	CHI
20201238115	BELA VISTA DE GOIAS	BV31011045	BELA VISTA S1	08/12/2020 09:51	08/12/2020 11:25	08/12/2020 09:51	08/12/2020 11:25	1,56	1	1,56	CHI
20201238116	AGUA FRIA DE GOIAS	TL21351597	SAO JOAO D ALIANCA	08/12/2020 09:51	08/12/2020 10:48	08/12/2020 09:51	08/12/2020 10:48	0,94	1	0,94	CHI
20201238122	RIO VERDE	RV12384632	CABRIUVA S2	08/12/2020 09:52	08/12/2020 12:17	08/12/2020 09:52	08/12/2020 12:17	2,40	1	2,40	CHI
20201238123	ANICUNS	AC11105825	ANICUNS	08/12/2020 09:52	08/12/2020 11:06	08/12/2020 09:52	08/12/2020 11:06	1,22	159	193,98	CHI
20201238127	ANAPOLIS	AN11317785	ANAPOLIS UNIVERSITARIO S2	08/12/2020 09:53	08/12/2020 13:54	08/12/2020 09:53	08/12/2020 13:54	4,01	69	276,48	CHI
20201238131	COLINAS DO SUL	TI12155523RE	MINACU	08/12/2020 09:53	08/12/2020 12:01	08/12/2020 09:53	08/12/2020 12:01	2,12	18	38,10	CHI
20201238429	ALEXANIA	7595419	ALEXANIA	08/12/2020 09:53	09/12/2020 09:48	08/12/2020 09:53	09/12/2020 09:48	23,91	18	430,40	CHI
20201238135	ALTO HORIZONTE	MQ12262458	MARA ROSA	08/12/2020 09:54	10/12/2020 01:22	08/12/2020 09:54	10/12/2020 01:22	39,47	2	78,94	CHI
20201238135	MARA ROSA	MQ12262458	MARA ROSA	08/12/2020 09:54	10/12/2020 01:22	08/12/2020 09:54	10/12/2020 01:22	39,47	2	78,94	CHI
20201238141	GOIANAPOLIS	950001375	DAIA S2	08/12/2020 09:55	08/12/2020 11:51	08/12/2020 09:55	08/12/2020 11:51	1,92	1	1,92	CHI
20201238142	MINEIROS	MY21324359	PARQUE DAS EMAS	08/12/2020 09:55	08/12/2020 19:11	08/12/2020 09:55	08/12/2020 19:11	9,26	1	9,26	CHI
20201238144	JUSSARA	RN21138486	BRITANIA	08/12/2020 09:55	08/12/2020 17:50	08/12/2020 09:55	08/12/2020 17:50	7,90	2	15,80	CHI
20201238146	BOM JARDIM DE GOIAS	BM12334788	BOM JARDIM	08/12/2020 09:57	08/12/2020 20:53	08/12/2020 09:57	08/12/2020 20:53	10,93	3	32,80	CHI
20201238151	NIQUELANDIA	NQ21237379	URUCU	08/12/2020 09:57	08/12/2020 12:28	08/12/2020 09:57	08/12/2020 12:28	2,51	1	2,51	CHI
20201238159	PARAUNA	PU21393664	PALMEIRAS	08/12/2020 09:58	08/12/2020 17:44	08/12/2020 09:58	08/12/2020 17:44	7,76	1	7,76	CHI
20201238163	PALESTINA DE GOIAS	3370005783	PALESTINA	08/12/2020 09:58	08/12/2020 16:48	08/12/2020 09:58	08/12/2020 16:48	6,82	1	6,82	CHI
20201238170	GOIANESIA	GE21223766	GOIANESIA S2	08/12/2020 09:59	09/12/2020 01:45	08/12/2020 09:59	09/12/2020 01:45	15,76	1	15,76	CHI
20201238173	CORUMBA DE GOIAS	ZN21201346	COCALZINHO	08/12/2020 09:59	08/12/2020 16:27	08/12/2020 09:59	08/12/2020 16:27	6,45	1	6,45	CHI
20201238174	FORMOSA	FA12116856	SAO JOAO D ALIANCA	08/12/2020 09:59	08/12/2020 14:49	08/12/2020 09:59	08/12/2020 14:49	4,82	6	28,91	CHI
20201238179	CACU	CC21028257	CACHOEIRA ALTA	08/12/2020 10:00	08/12/2020 12:24	08/12/2020 10:00	08/12/2020 12:24	2,38	1	2,38	CHI
20201238400	APORE	AE21205127	ITAJA S1	08/12/2020 10:00	08/12/2020 13:24	08/12/2020 10:00	08/12/2020 13:24	3,39	1	3,39	CHI
202012179346	IPAMERI	CM10415031	CAMPO ALEGRE DE GOIAS	08/12/2020 10:00	08/12/2020 23:34	08/12/2020 10:00	08/12/2020 16:39	6,64	4	26,58	CHI
202012179346	CAMPO ALEGRE DE GOIAS	CM10415031	CAMPO ALEGRE DE GOIAS	08/12/2020 10:00	08/12/2020 23:34	08/12/2020 10:00	08/12/2020 16:39	6,64	6	39,87	CHI
202012179346	IPAMERI	CM10415031	CAMPO ALEGRE DE GOIAS	08/12/2020 10:00	08/12/2020 23:34	08/12/2020 10:00	08/12/2020 19:52	9,87	78	770,16	CHI
202012179346	CAMPO ALEGRE DE GOIAS	CM10415031	CAMPO ALEGRE DE GOIAS	08/12/2020 10:00	08/12/2020 23:34	08/12/2020 10:00	08/12/2020 19:52	9,87	84	829,41	CHI
202012179346	CAMPO ALEGRE DE GOIAS	CM10415031	CAMPO ALEGRE DE GOIAS	08/12/2020 10:00	08/12/2020 23:34	08/12/2020 10:00	08/12/2020 23:34	13,56	1	13,56	CHI
20201238182	QUIRINOPOLIS	QI21154004	QUIRINOPOLIS	08/12/2020 10:01	08/12/2020 13:30	08/12/2020 10:01	08/12/2020 13:30	3,48	1	3,48	CHI
20201238185	ANAPOLIS	21151477	JUNDIAI S2	08/12/2020 10:01	08/12/2020 15:02	08/12/2020 10:01	08/12/2020 15:02	5,02	1	5,02	CHI
20201238186	CRIXAS	CX12248286	SERRA DO OURO	08/12/2020 10:01	08/12/2020 14:31	08/12/2020 10:01	08/12/2020 14:31	4,49	17	76,30	CHI
20201238193	RIO VERDE	RV21022574	MONTIVIDIU T	08/12/2020 10:02	08/12/2020 14:27	08/12/2020 10:02	08/12/2020 14:27	4,41	1	4,41	CHI
20201238197	PIRENOPOLIS	PV21196763	CORUMBA	08/12/2020 10:02	08/12/2020 15:36	08/12/2020 10:02	08/12/2020 15:36	5,56	1	5,56	CHI
20201238198	NOVO GAMA	NJ11128768	PACAEMBU S2	08/12/2020 10:02	08/12/2020 12:14	08/12/2020 10:02	08/12/2020 12:14	2,19	79	172,99	CHI
20201238200	APARECIDA DE GOIANIA	10029261510	INDEPENDENCIA S2	08/12/2020 10:02	08/12/2020 11:23	08/12/2020 10:02	08/12/2020 11:23	1,34	1	1,34	CHI
20201238205	AGUA FRIA DE GOIAS	TL12302766	SAO JOAO D ALIANCA	08/12/2020 10:03	09/12/2020 16:54	08/12/2020 10:03	08/12/2020 14:11	4,13	28	115,58	CHI
20201238205	AGUA FRIA DE GOIAS	TL12161804LD	SAO JOAO D ALIANCA	08/12/2020 10:03	09/12/2020 16:54	08/12/2020 10:03	08/12/2020 16:06	6,05	49	296,41	CHI
20201238205	AGUA FRIA DE GOIAS	TL12302766	SAO JOAO D ALIANCA	08/12/2020 10:03	09/12/2020 16:54	08/12/2020 17:28	08/12/2020 17:54	0,42	77	32,21	CHI
20201238205	AGUA FRIA DE GOIAS	JL12269023LD	SAO JOAO D ALIANCA	08/12/2020 10:03	09/12/2020 16:54	08/12/2020 10:03	09/12/2020 16:54	30,84	2	61,69	CHI
20201238205	SAO JOAO D ALIANCA	JL12269023LD	SAO JOAO D ALIANCA	08/12/2020 10:03	09/12/2020 16:54	08/12/2020 10:03	09/12/2020 16:54	30,84	1	30,84	CHI
20201238217	CORREGO DO OURO	CO21206020	FIRMINOPOLIS S2	08/12/2020 10:05	08/12/2020 14:38	08/12/2020 10:05	08/12/2020 14:38	4,53	1	4,53	CHI
20201238218	TRINDADE	10005306017	GOYA S2	08/12/2020 10:05	08/12/2020 13:28	08/12/2020 10:05	08/12/2020 13:28	3,37	1	3,37	CHI
20201238388	BURITINOPOLIS	BQ12190586	IACIARA S2	08/12/2020 10:05	08/12/2020 10:59	08/12/2020 10:05	08/12/2020 10:59	0,90	14	12,57	CHI
20201238295	MUNDO NOVO DE GOIAS	MH11254826	NOVA CRIXAS	08/12/2020 10:06	08/12/2020 14:51	08/12/2020 10:06	08/12/2020 14:51	4,75	184	873,69	CHI
20201238225	INHUMAS	IN21066359	INHUMAS S2	08/12/2020 10:07	08/12/2020 12:54	08/12/2020 10:07	08/12/2020 12:54	2,78	1	2,78	CHI
20201238229	RIO VERDE	RV21202814	CABRIUVA S1	08/12/2020 10:07	08/12/2020 11:47	08/12/2020 10:07	08/12/2020 11:47	1,66	2	3,31	CHI
20201238230	CATALAO	CT12333401	CATALAO S1	08/12/2020 10:07	08/12/2020 11:35	08/12/2020 10:07	08/12/2020 11:35	1,45	7	10,18	CHI
20201238232	PIRACANJUBA	PJ12394016	CRISTIANOPOLIS	08/12/2020 10:08	08/12/2020 14:15	08/12/2020 10:08	08/12/2020 14:15	4,12	2	8,23	CHI
20201238234	MONTIVIDIU	MV12226282	MONTIVIDIU T	08/12/2020 10:08	09/12/2020 10:22	08/12/2020 10:08	09/12/2020 10:22	24,23	1	24,23	CHI
20201238236	GOIAS	GS21168942	ITABERAI S1	08/12/2020 10:08	08/12/2020 11:33	08/12/2020 10:08	08/12/2020 11:33	1,40	1	1,40	CHI

20201238745	JUSSARA	RN12057000	BRITANIA	08/12/2020 10:08	09/12/2020 10:46	08/12/2020 10:08	09/12/2020 10:46	24,62	4	98,49	CHI
20201238745	SANTA FE DE GOIAS	RN12057000	BRITANIA	08/12/2020 10:08	09/12/2020 10:46	08/12/2020 10:08	09/12/2020 10:46	24,62	1	24,62	CHI
20201238244	APARECIDA DE GOIANIA	10007441353	INDEPENDENCIA S2	08/12/2020 10:10	08/12/2020 11:19	08/12/2020 10:10	08/12/2020 11:19	1,14	1	1,14	CHI
20201238245	JATAI	JT21184202	JATAI S2	08/12/2020 10:10	09/12/2020 08:26	08/12/2020 10:10	09/12/2020 08:26	22,26	1	22,26	CHI
20201238250	CACU	CC21154726	CACHOEIRA ALTA	08/12/2020 10:10	08/12/2020 14:50	08/12/2020 10:10	08/12/2020 14:50	4,65	1	4,65	CHI
20201238252	CATALAO	1990080653	CATALAO S2	08/12/2020 10:11	08/12/2020 11:54	08/12/2020 10:11	08/12/2020 11:54	1,71	1	1,71	CHI
20201238255	PALMEIRAS DE GOIAS	10022712974	PALMEIRAS	08/12/2020 10:11	08/12/2020 12:59	08/12/2020 10:11	08/12/2020 12:59	2,79	1	2,79	CHI
20201238256	CACHOEIRA ALTA	CA21163366	CACHOEIRA ALTA	08/12/2020 10:11	08/12/2020 12:11	08/12/2020 10:11	08/12/2020 12:11	1,98	1	1,98	CHI
20201239692	MONTIVIDIU DO NORTE	MX12139181	PORANGATU	08/12/2020 10:11	08/12/2020 17:27	08/12/2020 10:11	08/12/2020 17:27	7,26	163	1183,15	CHI
20201238261	QUIRINOPOLIS	QI31214206	QUIRINOPOLIS	08/12/2020 10:13	08/12/2020 15:05	08/12/2020 10:13	08/12/2020 15:05	4,86	1	4,86	CHI
20201238263	ANAPOLIS	10003804990	JUNDIAI S2	08/12/2020 10:13	08/12/2020 12:43	08/12/2020 10:13	08/12/2020 12:43	2,49	1	2,49	CHI
20201238276	CRISTALINA	KR12331959	CRISTALINA S1	08/12/2020 10:15	08/12/2020 14:44	08/12/2020 10:15	08/12/2020 14:44	4,48	1	4,48	CHI
20201238278	TRINDADE	40146200	TRINDADE	08/12/2020 10:16	08/12/2020 15:27	08/12/2020 10:16	08/12/2020 15:27	5,18	1	5,18	CHI
20201238279	GOIANESIA	550008068	GOIANESIA S2	08/12/2020 10:16	08/12/2020 22:11	08/12/2020 10:16	08/12/2020 22:11	11,91	1	11,91	CHI
20201238281	NOVO BRASIL	NB12376361	FIRMINOPOLIS S2	08/12/2020 10:17	08/12/2020 12:29	08/12/2020 10:17	08/12/2020 12:29	2,18	7	15,29	CHI
20201238282	CRISTALINA	KR11287413	CRISTALINA S1	08/12/2020 10:18	08/12/2020 13:24	08/12/2020 10:18	08/12/2020 13:24	3,09	5	15,45	CHI
20201238287	QUIRINOPOLIS	QI21091053	QUIRINOPOLIS	08/12/2020 10:19	08/12/2020 16:24	08/12/2020 10:19	08/12/2020 16:24	6,07	1	6,07	CHI
20201238304	LUZIANIA	LZ12110889	RIO VERMELHO	08/12/2020 10:19	10/12/2020 22:51	08/12/2020 10:19	10/12/2020 10:36	48,29	1	48,29	CHI
20201238304	LUZIANIA	LZ12110889	RIO VERMELHO	08/12/2020 10:19	10/12/2020 22:51	08/12/2020 10:19	10/12/2020 11:06	48,79	1	48,79	CHI
20201238304	LUZIANIA	LZ12110889	RIO VERMELHO	08/12/2020 10:19	10/12/2020 22:51	08/12/2020 10:19	10/12/2020 11:54	49,59	1	49,59	CHI
20201238304	LUZIANIA	LZ12110889	RIO VERMELHO	08/12/2020 10:19	10/12/2020 22:51	10/12/2020 12:36	10/12/2020 19:39	7,05	1	7,05	CHI
20201238304	LUZIANIA	LZ12110889	RIO VERMELHO	08/12/2020 10:19	10/12/2020 22:51	10/12/2020 12:36	10/12/2020 22:50	10,24	1	10,24	CHI
20201238304	LUZIANIA	LZ12110889	RIO VERMELHO	08/12/2020 10:19	10/12/2020 22:51	08/12/2020 10:19	10/12/2020 22:51	60,54	1	60,54	CHI
20201238304	LUZIANIA	LZ12110889	RIO VERMELHO	08/12/2020 10:19	10/12/2020 22:51	08/12/2020 10:19	10/12/2020 22:51	60,55	3	181,64	CHI
20201258478	LUZIANIA	LZ21110807	RIO VERMELHO	08/12/2020 10:19	11/12/2020 08:53	10/12/2020 12:36	11/12/2020 08:53	20,28	1	20,28	CHI
20201238289	ITAPACI	IW21238560	RUBIATABA	08/12/2020 10:20	08/12/2020 16:50	08/12/2020 10:20	08/12/2020 16:50	6,49	1	6,49	CHI
20201238301	VICENTINOPOLIS	10028369520	VICENTINOPOLIS	08/12/2020 10:22	09/12/2020 08:42	08/12/2020 10:22	09/12/2020 08:42	22,33	1	22,33	CHI
20201238303	QUIRINOPOLIS	QI21306148	QUIRINOPOLIS	08/12/2020 10:22	08/12/2020 16:52	08/12/2020 10:22	08/12/2020 16:52	6,49	1	6,49	CHI
20201238624	ARENOPOLIS	AY12390162	ARENOPOLIS	08/12/2020 10:22	09/12/2020 09:35	08/12/2020 10:22	09/12/2020 09:35	23,21	5	116,06	CHI
20201238308	INHUMAS	30124074	INHUMAS S2	08/12/2020 10:23	08/12/2020 17:08	08/12/2020 10:23	08/12/2020 17:08	6,74	1	6,74	CHI
20201238329	TRINDADE	10014478917	TRINDADE	08/12/2020 10:24	08/12/2020 13:45	08/12/2020 10:24	08/12/2020 13:45	3,35	1	3,35	CHI
20201238331	PONTALINA	PK21247823	PONTALINA	08/12/2020 10:24	08/12/2020 11:33	08/12/2020 10:24	08/12/2020 11:33	1,14	1	1,14	CHI
20201238335	PEROLANDIA	JT12260433	JATAI S1	08/12/2020 10:25	08/12/2020 17:45	08/12/2020 10:25	08/12/2020 17:45	7,32	6	43,93	CHI
20201238335	JATAI	JT12260433	JATAI S1	08/12/2020 10:25	08/12/2020 17:45	08/12/2020 10:25	08/12/2020 17:45	7,32	1	7,32	CHI
20201238338	LUZIANIA	10026652658	RIO VERMELHO	08/12/2020 10:25	08/12/2020 13:06	08/12/2020 10:25	08/12/2020 13:06	2,67	1	2,67	CHI
20201238343	MINEIROS	MY21361753	PARQUE DAS EMAS	08/12/2020 10:26	08/12/2020 11:46	08/12/2020 10:26	08/12/2020 11:46	1,32	1	1,32	CHI
20201238346	BELA VISTA DE GOIAS	BV21099005	BELA VISTA S2	08/12/2020 10:27	08/12/2020 17:03	08/12/2020 10:27	08/12/2020 17:03	6,59	1	6,59	CHI
20201238349	BOM JESUS DE GOIAS	IT12352670	CACHOEIRA DOURADA	08/12/2020 10:28	08/12/2020 23:57	08/12/2020 10:28	08/12/2020 23:57	13,48	2	26,96	CHI
20201238349	ITUMBIAIRA	IT12352670	CACHOEIRA DOURADA	08/12/2020 10:28	08/12/2020 23:57	08/12/2020 10:28	08/12/2020 23:57	13,48	8	107,86	CHI
20201238351	TURVELANDIA	TD21384566	RIO DOS BOIS	08/12/2020 10:28	08/12/2020 15:35	08/12/2020 10:28	08/12/2020 15:35	5,11	1	5,11	CHI
20201238354	SANTA HELENA DE GOIAS	SH21023769	RIO DOS BOIS	08/12/2020 10:29	08/12/2020 11:42	08/12/2020 10:29	08/12/2020 11:42	1,21	1	1,21	CHI
20201238357	ANAPOLIS	20711219	JUNDIAI S2	08/12/2020 10:30	08/12/2020 12:51	08/12/2020 10:30	08/12/2020 12:51	2,34	1	2,34	CHI
20201238358	QUIRINOPOLIS	QI12296643	QUIRINOPOLIS	08/12/2020 10:30	08/12/2020 19:40	08/12/2020 13:20	08/12/2020 19:40	6,32	6	37,91	CHI
20201238957	MARA ROSA	MQ12263046	MARA ROSA	08/12/2020 10:31	08/12/2020 21:20	08/12/2020 10:31	08/12/2020 21:20	10,81	7	75,65	CHI
20201238363	NOVO PLANALTO	TA11293654	SAO MIGUEL DO ARAGUAIA	08/12/2020 10:32	08/12/2020 16:14	08/12/2020 10:32	08/12/2020 16:14	5,69	1	5,69	CHI
20201238364	CRIXAS	CX12243321	RUBIATABA	08/12/2020 10:33	08/12/2020 14:38	08/12/2020 10:33	08/12/2020 14:38	4,08	6	24,50	CHI
20201238366	AGUAS LINDAS DE GOIAS	10005693908	AGUAS LINDAS DE GOIAS S1	08/12/2020 10:33	08/12/2020 12:32	08/12/2020 10:33	08/12/2020 12:32	1,97	1	1,97	CHI
20201238383	NEROPOLIS	NR21010629	NEROPOLIS S2	08/12/2020 10:36	08/12/2020 13:13	08/12/2020 10:36	08/12/2020 13:13	2,61	2	5,22	CHI
20201238385	SILVANIA	SV12205354	DAIA S2	08/12/2020 10:36	08/12/2020 12:37	08/12/2020 10:36	08/12/2020 12:37	2,01	39	78,31	CHI
20201238390	BURITI DE GOIAS	BS21166205	FIRMINOPOLIS S2	08/12/2020 10:37	09/12/2020 08:39	08/12/2020 10:37	09/12/2020 08:39	22,03	2	44,06	CHI
20201238395	MINACU	4020063061	MINACU	08/12/2020 10:38	09/12/2020 03:35	08/12/2020 10:38	09/12/2020 03:35	16,95	1	16,95	CHI

20201238403	IPORA	IR12374853	IPORA	08/12/2020 10:38	09/12/2020 10:09	08/12/2020 10:38	09/12/2020 10:09	23,50	2	47,01	CHI
20201238405	CACHOEIRA DOURADA	CD21000001	CACHOEIRA DOURADA	08/12/2020 10:39	08/12/2020 12:31	08/12/2020 10:39	08/12/2020 12:31	1,86	2	3,72	CHI
20201238418	MAIRIPOTABA	PK12063360	PONTALINA	08/12/2020 10:42	08/12/2020 16:32	08/12/2020 10:42	08/12/2020 16:32	5,83	3	17,49	CHI
20201238422	CATALAO	CT12039946RE	CATALAO S1	08/12/2020 10:43	08/12/2020 12:24	08/12/2020 10:43	08/12/2020 12:24	1,68	18	30,30	CHI
20201238423	QUIRINOPOLIS	QI21207168	QUIRINOPOLIS	08/12/2020 10:43	08/12/2020 16:13	08/12/2020 10:43	08/12/2020 16:13	5,50	1	5,50	CHI
20201238424	APORE	AE21041753	ITAJA S1	08/12/2020 10:43	08/12/2020 20:29	08/12/2020 10:43	08/12/2020 20:29	9,76	1	9,76	CHI
20201238428	PIRACANJUBA	60108071	PIRACANJUBA	08/12/2020 10:43	09/12/2020 11:21	08/12/2020 10:43	09/12/2020 11:21	24,62	1	24,62	CHI
20201238976	POSSE	PS12124656	IACIARA S2	08/12/2020 10:43	08/12/2020 13:05	08/12/2020 10:43	08/12/2020 13:05	2,36	96	226,75	CHI
20201239185	GOIANESIA	GE11041795	GOIANESIA S2	08/12/2020 10:43	09/12/2020 08:40	08/12/2020 10:43	09/12/2020 08:40	21,94	62	1360,57	CHI
20201238547	SANTA RITA DO NOVO DESTINO	BA12208878	BARRO ALTO	08/12/2020 10:44	08/12/2020 14:26	08/12/2020 10:44	08/12/2020 14:26	3,70	4	14,79	CHI
20201238440	MARA ROSA	MQ21284446	SANTA TEREZINHA	08/12/2020 10:45	09/12/2020 22:56	08/12/2020 10:45	09/12/2020 22:56	36,17	1	36,17	CHI
20201238441	NOVO GAMA	4990035952	PACAEMBU S1	08/12/2020 10:45	08/12/2020 12:03	08/12/2020 10:45	08/12/2020 12:03	1,29	1	1,29	CHI
20201238443	BURITI DE GOIAS	BS12233507	FIRMINOPOLIS S2	08/12/2020 10:46	09/12/2020 09:53	08/12/2020 10:46	09/12/2020 09:53	23,12	2	46,24	CHI
20201238452	POSSE	PS21106656	IACIARA S2	08/12/2020 10:47	08/12/2020 12:45	08/12/2020 10:47	08/12/2020 12:45	1,95	2	3,90	CHI
20201238578	CRISTALINA	KR12230241	CRISTALINA S2	08/12/2020 10:48	08/12/2020 12:29	08/12/2020 10:48	08/12/2020 12:29	1,67	5	8,35	CHI
20201238462	SANTO ANTONIO DO DESCOBERTO	SN21386393	MARAJOARA	08/12/2020 10:49	08/12/2020 14:20	08/12/2020 10:49	08/12/2020 14:20	3,51	3	10,53	CHI
20201238479	RIO VERDE	RV10427213	MONTIVIDIU T	08/12/2020 10:49	09/12/2020 17:27	08/12/2020 10:49	08/12/2020 14:25	3,59	7	25,11	CHI
20201238479	RIO VERDE	RV13383948	MONTIVIDIU T	08/12/2020 10:49	09/12/2020 17:27	08/12/2020 10:49	09/12/2020 11:51	25,04	1	25,04	CHI
20201238479	RIO VERDE	20420621	MONTIVIDIU T	08/12/2020 10:49	09/12/2020 17:27	08/12/2020 10:49	09/12/2020 17:27	30,62	1	30,62	CHI
20201238469	JARAGUA	JA12035312	JARAGUA	08/12/2020 10:50	08/12/2020 18:33	08/12/2020 10:50	08/12/2020 18:33	7,71	1	7,71	CHI
20201238558	PARANAIGUARA	PC12370096	QUIRINOPOLIS	08/12/2020 10:51	08/12/2020 14:02	08/12/2020 10:51	08/12/2020 14:02	3,18	3	9,54	CHI
20201238474	ITARUMA	IM21205205	CACHOEIRA ALTA	08/12/2020 10:52	08/12/2020 13:28	08/12/2020 10:52	08/12/2020 13:28	2,60	1	2,60	CHI
20201238482	PIRENOPOLIS	10002789106	CORUMBA	08/12/2020 10:53	08/12/2020 20:30	08/12/2020 10:53	08/12/2020 20:30	9,61	1	9,61	CHI
20201238495	NIQUELANDIA	2750106467	RIOQUELANDIA SUBTRANSMISSAO	08/12/2020 10:55	08/12/2020 11:32	08/12/2020 10:55	08/12/2020 11:32	0,60	1	0,60	CHI
20201238499	AGUA FRIA DE GOIAS	TL21337450	SAO JOAO D ALIANCA	08/12/2020 10:57	09/12/2020 11:33	08/12/2020 10:57	09/12/2020 11:33	24,60	1	24,60	CHI
20201238503	GOIANIA	14964375	FERROVIARIO S2	08/12/2020 10:58	08/12/2020 12:35	08/12/2020 10:58	08/12/2020 12:35	1,61	1	1,61	CHI
20201238507	APARECIDA DE GOIANIA	16435485	REAL S2	08/12/2020 10:59	08/12/2020 14:31	08/12/2020 10:59	08/12/2020 14:31	3,53	1	3,53	CHI
20201238510	PONTALINA	PK21229012	VICENTINOPOLIS	08/12/2020 11:00	08/12/2020 13:23	08/12/2020 11:00	08/12/2020 13:23	2,38	1	2,38	CHI
20201238511	AGUA LIMPA	AL12245823	VILA CORUMBA	08/12/2020 11:00	08/12/2020 15:39	08/12/2020 11:00	08/12/2020 15:39	4,65	1	4,65	CHI
20201238515	SILVANIA	660027707	VIANOPOLIS	08/12/2020 11:01	08/12/2020 14:49	08/12/2020 11:01	08/12/2020 14:49	3,80	1	3,80	CHI
20201238518	MINACU	4020000830	MINACU	08/12/2020 11:01	08/12/2020 15:08	08/12/2020 11:01	08/12/2020 15:08	4,10	1	4,10	CHI
20201238520	PADRE BERNARDO	PB21275042	PADRE BERNARDO	08/12/2020 11:01	08/12/2020 16:01	08/12/2020 11:01	08/12/2020 16:01	4,99	1	4,99	CHI
20201238565	LUZIANIA	LZ12028134	RIO VERMELHO	08/12/2020 11:01	08/12/2020 12:58	08/12/2020 11:01	08/12/2020 12:58	1,94	499	965,70	CHI
20201238865	AGUA LIMPA	AL12391494RE	VILA CORUMBA	08/12/2020 11:01	08/12/2020 14:12	08/12/2020 11:01	08/12/2020 14:12	3,17	15	47,55	CHI
20201238521	HIDROLANDIA	180030607	CEPAIGO S2	08/12/2020 11:02	08/12/2020 13:06	08/12/2020 11:02	08/12/2020 13:06	2,06	1	2,06	CHI
20201238533	GOIANAPOLIS	GP21077909	JUNDIAI S1	08/12/2020 11:03	08/12/2020 18:05	08/12/2020 11:03	08/12/2020 18:05	7,03	1	7,03	CHI
20201238537	APORE	AE12041637	ITAJA S1	08/12/2020 11:03	08/12/2020 17:43	08/12/2020 11:03	08/12/2020 17:43	6,66	1	6,66	CHI
20201238542	DOVERLANDIA	DV21119468	CAIAPONIA	08/12/2020 11:05	09/12/2020 15:11	08/12/2020 11:05	09/12/2020 15:11	28,10	1	28,10	CHI
20201238546	IPAMERI	IP12107653	IPAMERI	08/12/2020 11:05	08/12/2020 19:18	08/12/2020 11:05	08/12/2020 19:18	8,20	88	721,82	CHI
20201238546	CORUMBAIBA	IP12107653	IPAMERI	08/12/2020 11:05	08/12/2020 19:18	08/12/2020 11:05	08/12/2020 19:18	8,20	3	24,61	CHI
20201238546	CALDAS NOVAS	IP12107653	IPAMERI	08/12/2020 11:05	08/12/2020 19:18	08/12/2020 11:05	08/12/2020 19:18	8,20	11	90,23	CHI
20201238556	RUBIATABA	780028946	RUBIATABA	08/12/2020 11:06	08/12/2020 16:30	08/12/2020 11:06	08/12/2020 16:30	5,38	1	5,38	CHI
20201238562	MORRINHOS	10002338260	MORRINHOS	08/12/2020 11:08	08/12/2020 16:24	08/12/2020 11:08	08/12/2020 16:24	5,26	1	5,26	CHI
20201238564	QUIRINOPOLIS	QI12360912LD	QUIRINOPOLIS	08/12/2020 11:08	08/12/2020 16:28	08/12/2020 11:08	08/12/2020 16:28	5,32	33	175,56	CHI
20201238564	RIO VERDE	QI12360912LD	QUIRINOPOLIS	08/12/2020 11:08	08/12/2020 16:28	08/12/2020 11:08	08/12/2020 16:28	5,32	7	37,24	CHI
20201238566	FLORES DE GOIAS	FB12421836	FLORES DE GOIAS	08/12/2020 11:09	08/12/2020 17:04	08/12/2020 11:09	08/12/2020 17:04	5,91	24	141,86	CHI
20201238580	PIRENOPOLIS	PV21316022	CORUMBA	08/12/2020 11:12	08/12/2020 14:41	08/12/2020 11:12	08/12/2020 14:41	3,48	6	20,86	CHI
20201242965	DOVERLANDIA	DV12156199	PARQUE DAS EMAS	08/12/2020 11:12	09/12/2020 11:03	08/12/2020 11:12	09/12/2020 11:03	23,83	11	262,18	CHI
20201238588	LUZIANIA	OZ12186208	PIRES DO RIO S2	08/12/2020 11:14	08/12/2020 14:19	08/12/2020 11:14	08/12/2020 14:19	3,08	32	98,45	CHI
20201238590	BONOPOLIS	BX11364602	SAO MIGUEL DO ARAGUAIA	08/12/2020 11:14	08/12/2020 15:09	08/12/2020 11:14	08/12/2020 15:09	3,90	1	3,90	CHI
20201239199	MINACU	IH12346526	MINACU	08/12/2020 11:15	08/12/2020 15:18	08/12/2020 11:15	08/12/2020 15:18	4,03	69	278,38	CHI

20201238612	CAIAPONIA	CP21154335	PALESTINA	08/12/2020 11:17	08/12/2020 15:20	08/12/2020 11:17	08/12/2020 15:20	4,04	1	4,04	CHI
20201238613	VALPARAISO DE GOIAS	2860371819	PACAEMBU S2	08/12/2020 11:17	08/12/2020 12:31	08/12/2020 11:17	08/12/2020 12:31	1,22	1	1,22	CHI
20201238874	SAO LUIZ DO NORTE	SZ12237361	BARRO ALTO	08/12/2020 11:17	08/12/2020 14:30	08/12/2020 11:17	08/12/2020 14:30	3,21	6	19,26	CHI
20201238630	BOM JESUS DE GOIAS	BJ12000149RE	BOM JESUS DE GOIAS	08/12/2020 11:21	08/12/2020 20:00	08/12/2020 11:21	08/12/2020 20:00	8,64	18	155,54	CHI
20201238643	ITABERAI	IB12379732	ITABERAI S1	08/12/2020 11:23	08/12/2020 13:57	08/12/2020 11:23	08/12/2020 13:57	2,55	2	5,10	CHI
20201238644	FORMOSA	610058204	ITUIQUIRA	08/12/2020 11:24	08/12/2020 12:15	08/12/2020 11:24	08/12/2020 12:15	0,85	1	0,85	CHI
20201238645	CALDAS NOVAS	760416291	SERRA DE CALDAS	08/12/2020 11:24	08/12/2020 18:58	08/12/2020 11:24	08/12/2020 18:58	7,56	1	7,56	CHI
20201238647	JATAI	290003258	JATAI S2	08/12/2020 11:25	09/12/2020 03:17	08/12/2020 11:25	09/12/2020 03:17	15,87	1	15,87	CHI
20201238648	APARECIDA DE GOIANIA	200326867	INDEPENDENCIA S1	08/12/2020 11:25	08/12/2020 14:27	08/12/2020 11:25	08/12/2020 14:27	3,03	1	3,03	CHI
20201238652	QUIRINOPOLIS	QI21319948	QUIRINOPOLIS	08/12/2020 11:26	09/12/2020 08:16	08/12/2020 11:26	09/12/2020 08:16	20,83	1	20,83	CHI
20201238654	PORANGATU	PO21137644	PORANGATU	08/12/2020 11:26	08/12/2020 12:45	08/12/2020 11:26	08/12/2020 12:45	1,31	2	2,61	CHI
20201238657	CORUMBAIBA	CI21000477	VILA CORUMBA	08/12/2020 11:26	09/12/2020 09:22	08/12/2020 11:26	09/12/2020 09:22	21,92	1	21,92	CHI
20201238672	NOVA CRIXAS	03960224	NOVA CRIXAS	08/12/2020 11:26	08/12/2020 16:45	08/12/2020 11:26	08/12/2020 16:45	5,31	1225	6499,65	CHI
20201238658	CACHOEIRA ALTA	CA21075256	CACHOEIRA ALTA	08/12/2020 11:27	08/12/2020 12:46	08/12/2020 11:27	08/12/2020 12:46	1,31	1	1,31	CHI
20201238665	GOIANIA	16665260	FERROVIARIO S1	08/12/2020 11:28	08/12/2020 13:16	08/12/2020 11:28	08/12/2020 13:16	1,79	1	1,79	CHI
20201238667	PARAUNA	EU21000199	ACREUNA	08/12/2020 11:28	08/12/2020 20:09	08/12/2020 11:28	08/12/2020 20:09	8,67	3	26,01	CHI
20201238673	GOIANIA	12683838	MEIA PONTE	08/12/2020 11:29	08/12/2020 12:18	08/12/2020 11:29	08/12/2020 12:18	0,81	1	0,81	CHI
20201240560	SAO LUIZ DO NORTE	SZ12236801	BARRO ALTO	08/12/2020 11:29	08/12/2020 16:30	08/12/2020 11:29	08/12/2020 16:30	5,01	22	110,17	CHI
20201239232	DIORAMA	DI12065689	IPORA	08/12/2020 11:30	09/12/2020 12:10	08/12/2020 11:30	09/12/2020 12:10	24,67	15	370,00	CHI
20201238695	LUZIANIA	LZ11216266	RIO VERMELHO	08/12/2020 11:33	08/12/2020 14:25	08/12/2020 11:33	08/12/2020 14:25	2,86	141	402,67	CHI
20201238703	OURO VERDE DE GOIAS	OV21107572	NEROPOLIS S1	08/12/2020 11:34	08/12/2020 15:20	08/12/2020 11:34	08/12/2020 15:20	3,76	1	3,76	CHI
20201238704	EDEIA	EA12257973	EDEIA	08/12/2020 11:34	08/12/2020 19:00	08/12/2020 11:34	08/12/2020 19:00	7,43	33	245,26	CHI
20201238704	INDIARA	EA12257973	EDEIA	08/12/2020 11:34	08/12/2020 19:00	08/12/2020 11:34	08/12/2020 19:00	7,43	7	52,03	CHI
20201238704	ACREUNA	EA12257973	EDEIA	08/12/2020 11:34	08/12/2020 19:00	08/12/2020 11:34	08/12/2020 19:00	7,43	13	96,62	CHI
20201238705	RIO VERDE	RV21260211	CABRIUVA S1	08/12/2020 11:34	08/12/2020 13:24	08/12/2020 11:34	08/12/2020 13:24	1,82	2	3,64	CHI
20201247874	SANTA RITA DO NOVO DESTINO	1150021680	BARRO ALTO	08/12/2020 11:34	09/12/2020 15:18	08/12/2020 11:34	09/12/2020 15:18	27,73	1	27,73	CHI
20201238718	EDEIA	1120020119	EDEIA	08/12/2020 11:37	08/12/2020 13:51	08/12/2020 11:37	08/12/2020 13:51	2,23	1	2,23	CHI
20201238721	CRISTALINA	KR21163712	CRISTALINA S2	08/12/2020 11:37	08/12/2020 18:16	08/12/2020 11:37	08/12/2020 18:16	6,64	1	6,64	CHI
20201238734	GOIANIA	10032078976	CAMPINAS S2	08/12/2020 11:39	08/12/2020 13:21	08/12/2020 11:39	08/12/2020 13:21	1,69	1	1,69	CHI
20201238739	GOIANESIA	GE21107738	GOIANESIA S1	08/12/2020 11:40	08/12/2020 13:00	08/12/2020 11:40	08/12/2020 13:00	1,32	1	1,32	CHI
20201238776	PALMEIRAS DE GOIAS	03300244	PALMEIRAS	08/12/2020 11:40	08/12/2020 17:29	08/12/2020 11:40	08/12/2020 17:29	0,10	257	24,77	CHI
20201238776	PALMEIRAS DE GOIAS	03300244	PALMEIRAS	08/12/2020 11:40	08/12/2020 17:29	08/12/2020 11:40	08/12/2020 17:29	1,13	109	122,84	CHI
20201238776	PALMEIRAS DE GOIAS	03300244	PALMEIRAS	08/12/2020 11:40	08/12/2020 17:29	08/12/2020 11:40	08/12/2020 17:29	2,50	50	124,85	CHI
20201238776	PALMEIRAS DE GOIAS	03300244	PALMEIRAS	08/12/2020 11:40	08/12/2020 17:29	08/12/2020 11:40	08/12/2020 17:12	5,54	118	653,46	CHI
20201238776	PALMEIRAS DE GOIAS	PL13000016	PALMEIRAS	08/12/2020 11:40	08/12/2020 17:29	08/12/2020 17:20	08/12/2020 17:29	0,16	50	7,76	CHI
20201238753	MARA ROSA	MQ16407727	MARA ROSA	08/12/2020 11:41	08/12/2020 23:50	08/12/2020 11:41	08/12/2020 14:09	2,47	401	988,58	CHI
20201238753	CAMPINORTE	MQ16408089	MARA ROSA	08/12/2020 11:41	08/12/2020 23:50	08/12/2020 11:41	08/12/2020 15:15	3,56	3	10,69	CHI
20201238753	MARA ROSA	MQ16408089	MARA ROSA	08/12/2020 11:41	08/12/2020 23:50	08/12/2020 11:41	08/12/2020 15:15	3,56	528	1882,32	CHI
20201238753	MARA ROSA	01120214	MARA ROSA	08/12/2020 11:41	08/12/2020 23:50	08/12/2020 15:26	08/12/2020 15:31	0,08	3910	303,03	CHI
20201238753	CAMPINORTE	01120214	MARA ROSA	08/12/2020 11:41	08/12/2020 23:50	08/12/2020 15:26	08/12/2020 15:31	0,08	24	1,86	CHI
20201238753	CAMPINORTE	MQ12286000LD	MARA ROSA	08/12/2020 11:41	08/12/2020 23:50	08/12/2020 11:41	08/12/2020 23:50	12,16	9	109,47	CHI
20201238753	MARA ROSA	MQ12286000LD	MARA ROSA	08/12/2020 11:41	08/12/2020 23:50	08/12/2020 11:41	08/12/2020 23:50	12,16	167	2031,28	CHI
20201238753	ESTRELA DO NORTE	MQ12286000LD	MARA ROSA	08/12/2020 11:41	08/12/2020 23:50	08/12/2020 11:41	08/12/2020 23:50	12,16	3	36,49	CHI
20201238753	ESTRELA DO NORTE	MQ12286000LD	MARA ROSA	08/12/2020 11:41	08/12/2020 23:50	08/12/2020 11:42	08/12/2020 23:50	12,14	4	48,56	CHI
20201240326	PONTALINA	PK12316644	VICENTINOPOLIS	08/12/2020 11:41	09/12/2020 08:19	08/12/2020 11:41	09/12/2020 08:19	20,62	2	41,25	CHI
20201231958	MINACU	IH12396742	MINACU	08/12/2020 11:43	08/12/2020 18:08	08/12/2020 11:43	08/12/2020 18:08	6,41	44	282,09	CHI
20201238749	AMARALINA	LC12241972	MARA ROSA	08/12/2020 11:43	09/12/2020 07:59	08/12/2020 11:43	09/12/2020 07:59	20,26	1	20,26	CHI
20201238754	BELA VISTA DE GOIAS	10027020205	BELA VISTA S1	08/12/2020 11:44	08/12/2020 14:57	08/12/2020 11:44	08/12/2020 14:57	3,21	1	3,21	CHI
20201238767	MINACU	4020062603	MINACU	08/12/2020 11:47	09/12/2020 01:34	08/12/2020 11:47	09/12/2020 01:34	13,78	1	13,78	CHI
20201240195	GOIATUBA	JV12000004RE	GOIATUBA S1	08/12/2020 11:47	08/12/2020 17:04	08/12/2020 11:47	08/12/2020 17:04	5,28	21	110,79	CHI
20201240195	JOVIANIA	JV12000004RE	GOIATUBA S1	08/12/2020 11:47	08/12/2020 17:04	08/12/2020 11:47	08/12/2020 17:04	5,28	10	52,76	CHI

20201238782	GOIAS	90037388	GOIAS	08/12/2020 11:50	08/12/2020 13:56	08/12/2020 11:50	08/12/2020 13:56	2,10	1	2,10	CHI
20201238786	URUACU	10032561340	URUACU	08/12/2020 11:52	08/12/2020 12:45	08/12/2020 11:52	08/12/2020 12:45	0,88	1	0,88	CHI
20201238958	GOIANIA	GN12044092LD	GOYA S1	08/12/2020 11:54	08/12/2020 16:58	08/12/2020 11:54	08/12/2020 16:58	5,06	26	131,52	CHI
20201238795	PORANGATU	PO21208407	PORANGATU	08/12/2020 11:55	08/12/2020 16:51	08/12/2020 11:55	08/12/2020 16:51	4,92	1	4,92	CHI
20201238796	ALOANDIA	AD12000011	GOIATUBA S1	08/12/2020 11:56	08/12/2020 14:34	08/12/2020 11:56	08/12/2020 14:34	2,63	1	2,63	CHI
20201241898	MINACU	IH11100834	MINACU	08/12/2020 11:57	09/12/2020 00:21	08/12/2020 11:57	09/12/2020 00:21	12,40	56	694,40	CHI
20201238813	MONTIVIDIU	MV12241233	MONTIVIDIU T	08/12/2020 11:58	08/12/2020 20:00	08/12/2020 11:58	08/12/2020 20:00	8,03	4	32,13	CHI
20201238806	PLANALTINA	PI12097115	PLANALTINA	08/12/2020 11:59	08/12/2020 15:03	08/12/2020 11:59	08/12/2020 15:03	3,06	1	3,06	CHI
20201239430	SAO MIGUEL DO ARAGUAIA	SM12020625	SAO MIGUEL DO ARAGUAIA	08/12/2020 12:01	08/12/2020 16:15	08/12/2020 12:01	08/12/2020 16:15	4,23	6	25,38	CHI
20201239069	POSSE	PS12104990	IACIARA S2	08/12/2020 12:02	08/12/2020 16:48	08/12/2020 12:02	08/12/2020 16:48	4,76	88	418,95	CHI
20201238819	TAQUARAL DE GOIAS	TQ12025627	ITABERAI S1	08/12/2020 12:03	08/12/2020 15:02	08/12/2020 12:03	08/12/2020 15:02	2,98	4	11,91	CHI
20201238820	ABADIANIA	8158225	ANAPOLIS UNIVERSITARIO S2	08/12/2020 12:03	08/12/2020 17:32	08/12/2020 15:14	08/12/2020 17:32	2,30	1	2,30	CHI
20201238823	EDEIA	EA21028569	VICENTINOPOLIS	08/12/2020 12:04	08/12/2020 19:58	08/12/2020 12:04	08/12/2020 19:58	7,90	1	7,90	CHI
20201238824	CORUMBA DE GOIAS	10029952474	CORUMBA	08/12/2020 12:04	09/12/2020 09:39	08/12/2020 12:04	09/12/2020 09:39	21,57	1	21,57	CHI
20201238826	SAO JOAO D ALIANCA	JL21237585	ITUIQUIRA	08/12/2020 12:05	09/12/2020 10:40	08/12/2020 12:05	09/12/2020 10:40	22,58	1	22,58	CHI
20201238847	QUIRINOPOLIS	QI12101226	QUIRINOPOLIS	08/12/2020 12:07	09/12/2020 00:47	08/12/2020 12:07	09/12/2020 00:47	12,66	20	253,16	CHI
20201240060	TURVELANDA	SH12301310	SANTA HELENA S1	08/12/2020 12:07	08/12/2020 20:34	08/12/2020 12:07	08/12/2020 20:34	8,44	5	42,18	CHI
20201240060	SANTA HELENA DE GOIAS	SH12301310	SANTA HELENA S1	08/12/2020 12:07	08/12/2020 20:34	08/12/2020 12:07	08/12/2020 20:34	8,44	1	8,44	CHI
20201238852	BARRO ALTO	GE12092176	GOIANESIA S1	08/12/2020 12:08	09/12/2020 14:12	08/12/2020 12:08	09/12/2020 14:12	26,06	1	26,06	CHI
20201238859	RIO VERDE	RV13371479B	RIO VERDE S1	08/12/2020 12:09	08/12/2020 17:11	08/12/2020 12:09	08/12/2020 17:11	5,03	355	1784,27	CHI
20201238859	SANTA HELENA DE GOIAS	RV13371479B	RIO VERDE S1	08/12/2020 12:09	08/12/2020 17:11	08/12/2020 12:09	08/12/2020 17:11	5,03	46	231,20	CHI
20201238862	PADRE BERNARDO	9980031791	PADRE BERNARDO	08/12/2020 12:10	08/12/2020 15:13	08/12/2020 12:10	08/12/2020 15:13	3,04	1	3,04	CHI
20201239324	FORMOSO	FO12000025	PORANGATU	08/12/2020 12:11	08/12/2020 15:22	08/12/2020 12:11	08/12/2020 15:22	3,18	449	1425,70	CHI
20201237865	QUIRINOPOLIS	QI12303070	QUIRINOPOLIS	08/12/2020 12:12	09/12/2020 01:03	08/12/2020 12:12	09/12/2020 01:03	12,84	26	333,83	CHI
20201238871	PIRENOPOLIS	PV21287464	CORUMBA	08/12/2020 12:12	09/12/2020 14:27	08/12/2020 12:12	09/12/2020 14:27	26,24	1	26,24	CHI
20201238873	PIRENOPOLIS	GE21134008	CORUMBA	08/12/2020 12:13	09/12/2020 17:05	08/12/2020 12:13	09/12/2020 17:05	28,86	1	28,86	CHI
20201238876	CIDADE OCIDENTAL	LZ21000326	MARAJOARA	08/12/2020 12:14	08/12/2020 17:23	08/12/2020 12:14	08/12/2020 17:23	5,15	1	5,15	CHI
20201238877	SENADOR CANEDO	SW11076743	CEPAIGO S1	08/12/2020 12:14	08/12/2020 15:37	08/12/2020 12:14	08/12/2020 15:37	3,38	12	40,57	CHI
20201238879	CACHOEIRA DOURADA	3280007377	CACHOEIRA DOURADA	08/12/2020 12:14	08/12/2020 23:36	08/12/2020 12:14	08/12/2020 23:36	11,35	1	11,35	CHI
20201238886	JATAI	JT12184194	JATAI S1	08/12/2020 12:14	09/12/2020 09:29	08/12/2020 12:14	09/12/2020 09:29	21,24	11	233,67	CHI
20201238884	ALEXANIA	AX11061988	ALEXANIA	08/12/2020 12:15	08/12/2020 14:32	08/12/2020 12:15	08/12/2020 14:32	2,27	169	383,44	CHI
20201238885	JATAI	JT12306879	JATAI S1	08/12/2020 12:16	08/12/2020 16:14	08/12/2020 12:16	08/12/2020 16:14	3,97	17	67,43	CHI
20201238887	AMARALINA	10026091761	MARA ROSA	08/12/2020 12:16	08/12/2020 21:44	08/12/2020 12:16	08/12/2020 21:44	9,46	1	9,46	CHI
20201238888	DOVERLANDIA	10031062235	CAIAPONIA	08/12/2020 12:16	08/12/2020 18:17	08/12/2020 12:16	08/12/2020 18:17	6,02	1	6,02	CHI
20201238899	BOM JESUS DE GOIAS	BJ18392097TS	BOM JESUS DE GOIAS	08/12/2020 12:18	08/12/2020 17:33	08/12/2020 12:18	08/12/2020 17:33	5,24	2	10,48	CHI
20201238899	ITUMBIARA	BJ18392097TS	BOM JESUS DE GOIAS	08/12/2020 12:18	08/12/2020 17:33	08/12/2020 12:18	08/12/2020 17:33	5,24	67	351,25	CHI
20201239293	BALIZA	BH12193310	BOM JARDIM	08/12/2020 12:18	08/12/2020 16:55	08/12/2020 12:18	08/12/2020 16:55	4,60	13	59,83	CHI
20201238905	LUZIANIA	LZ21153601	CRISTALINA S2	08/12/2020 12:19	08/12/2020 13:54	08/12/2020 12:19	08/12/2020 13:54	1,57	1	1,57	CHI
20201238907	CALDAS NOVAS	760349897	SERRA DE CALDAS	08/12/2020 12:19	08/12/2020 16:17	08/12/2020 12:19	08/12/2020 16:17	3,95	1	3,95	CHI
20201238923	MINEIROS	MY12209755	PARQUE DAS EMAS	08/12/2020 12:20	08/12/2020 22:32	08/12/2020 12:20	08/12/2020 22:32	10,20	17	173,32	CHI
20201239015	PARANAIGUARA	QI12054841	QUIRINOPOLIS	08/12/2020 12:20	08/12/2020 15:27	08/12/2020 12:20	08/12/2020 15:27	3,10	1	3,10	CHI
20201239015	QUIRINOPOLIS	QI12054841	QUIRINOPOLIS	08/12/2020 12:20	08/12/2020 15:27	08/12/2020 12:20	08/12/2020 15:27	3,10	17	52,76	CHI
20201238912	GOIANIA	10031007960	XAVANTES	08/12/2020 12:21	08/12/2020 14:50	08/12/2020 12:21	08/12/2020 14:50	2,48	1	2,48	CHI
20201238996	GOIANIA	GN11001272	ATLANTICO S2	08/12/2020 12:23	08/12/2020 13:43	08/12/2020 12:23	08/12/2020 13:43	1,32	109	143,61	CHI
20201238931	CAIAPONIA	DP12182008LD	JATAI S1	08/12/2020 12:25	08/12/2020 16:14	08/12/2020 12:25	08/12/2020 16:14	3,81	20	76,14	CHI
20201238931	PEROLANDIA	DP12182008LD	JATAI S1	08/12/2020 12:25	08/12/2020 16:14	08/12/2020 12:25	08/12/2020 16:14	3,81	14	53,30	CHI
20201238931	JATAI	DP12182008LD	JATAI S1	08/12/2020 12:25	08/12/2020 16:14	08/12/2020 12:25	08/12/2020 16:14	3,81	287	1092,67	CHI
20201240138	MAIRIPOTABA	MI12083332	PONTALINA	08/12/2020 12:26	09/12/2020 07:18	08/12/2020 12:26	09/12/2020 07:18	18,87	4	75,46	CHI
20201240591	APORE	AE12000051	ITAJA S1	08/12/2020 12:26	08/12/2020 23:42	08/12/2020 12:26	08/12/2020 23:42	11,26	7	78,85	CHI
20201238152	ESTRELA DO NORTE	ET18050738FS	MARA ROSA	08/12/2020 12:27	08/12/2020 18:55	08/12/2020 12:27	08/12/2020 18:55	6,45	12	77,43	CHI
20201238152	FORMOSO	ET18050738FS	MARA ROSA	08/12/2020 12:27	08/12/2020 18:55	08/12/2020 12:27	08/12/2020 18:55	6,45	74	477,46	CHI

20201238152	MARA ROSA	ET18050738FS	MARA ROSA	08/12/2020 12:27	08/12/2020 18:55	08/12/2020 12:27	08/12/2020 18:55	6,45	65	419,39	CHI
20201238955	CRISTALINA	KR21163077	CRISTALINA S2	08/12/2020 12:30	08/12/2020 22:11	08/12/2020 12:30	08/12/2020 22:11	9,68	1	9,68	CHI
20201238960	JATAI	JT21387388	CACHOEIRA ALTA	08/12/2020 12:31	09/12/2020 13:15	08/12/2020 12:31	09/12/2020 13:15	24,73	1	24,73	CHI
20201238961	JATAI	290263566	JATAI S2	08/12/2020 12:31	08/12/2020 19:49	08/12/2020 12:31	08/12/2020 19:49	7,29	1	7,29	CHI
20201240674	BOM JESUS DE GOIAS	BJ11163877	BOM JESUS DE GOIAS	08/12/2020 12:31	08/12/2020 22:01	08/12/2020 12:31	08/12/2020 22:01	9,49	84	797,44	CHI
20201238963	GOIANIA	15908367	GOIANIA LESTE S1	08/12/2020 12:32	08/12/2020 15:12	08/12/2020 12:32	08/12/2020 15:12	2,67	1	2,67	CHI
20201238965	CAMPESTRE DE GOIAS	CG12252073	TRINDADE	08/12/2020 12:33	08/12/2020 15:42	08/12/2020 12:33	08/12/2020 15:42	3,15	118	371,63	CHI
20201238970	SAO LUIZ DO NORTE	SZ21128501	ITAPACI	08/12/2020 12:35	08/12/2020 15:49	08/12/2020 12:35	08/12/2020 15:49	3,23	1	3,23	CHI
20201238974	PORANGATU	PO12262596	PORANGATU	08/12/2020 12:35	08/12/2020 15:20	08/12/2020 12:35	08/12/2020 15:20	2,74	38	104,06	CHI
20201239025	SAO JOAO DA PARAUNA	RP12099242	FIRMINOPOLIS S2	08/12/2020 12:35	08/12/2020 18:00	08/12/2020 12:35	08/12/2020 18:00	5,42	3	16,27	CHI
20201238989	ITAJA	IJ2200688	ITAJA S2	08/12/2020 12:37	09/12/2020 13:22	08/12/2020 12:37	09/12/2020 13:22	24,76	4	99,03	CHI
20201239492	PARAUNA	PU12205962	PARAUNA	08/12/2020 12:37	08/12/2020 15:50	08/12/2020 12:37	08/12/2020 15:50	3,21	2	6,42	CHI
20201239001	ITUMBIARA	IT21203912	ITUMBIARA NOVA	08/12/2020 12:39	09/12/2020 09:54	08/12/2020 12:39	09/12/2020 09:54	21,25	1	21,25	CHI
20201239007	ITABERAI	IB12022048	ITABERAI S2	08/12/2020 12:40	08/12/2020 15:39	08/12/2020 12:40	08/12/2020 15:39	2,98	13	38,71	CHI
20201239008	PONTALINA	PK31046068	PONTALINA	08/12/2020 12:40	08/12/2020 16:45	08/12/2020 12:40	08/12/2020 16:45	4,08	1	4,08	CHI
20201239202	RIO VERDE	RV12303286	CABRIUVA S2	08/12/2020 12:40	09/12/2020 00:04	08/12/2020 12:40	09/12/2020 00:04	11,39	9	102,49	CHI
20201241788	FLORES DE GOIAS	FB12143258	IACIARA S2	08/12/2020 12:40	08/12/2020 22:28	08/12/2020 12:40	08/12/2020 22:28	9,80	27	264,56	CHI
20201241788	ALVORADA DO NORTE	FB12143258	IACIARA S2	08/12/2020 12:40	08/12/2020 22:28	08/12/2020 12:40	08/12/2020 22:28	9,80	30	293,96	CHI
20201239013	LUZIANIA	3200007811	MARAJOARA	08/12/2020 12:41	08/12/2020 15:38	08/12/2020 12:41	08/12/2020 15:38	2,95	1	2,95	CHI
20201239016	CATALAO	CT21250204	CATALAO S1	08/12/2020 12:41	08/12/2020 16:55	08/12/2020 12:41	08/12/2020 16:55	4,22	1	4,22	CHI
20201239027	AGUAS LINDAS DE GOIAS	10012793890	AGUAS LINDAS DE GOIAS S1	08/12/2020 12:42	08/12/2020 16:50	08/12/2020 12:42	08/12/2020 16:50	4,12	1	4,12	CHI
20201239029	EDEIA	EA12000048	EDEIA	08/12/2020 12:42	08/12/2020 22:08	08/12/2020 12:42	08/12/2020 22:08	9,42	32	301,38	CHI
20201239068	ITAPIRAPUA	IU12121382	MATRINCHA	08/12/2020 12:42	08/12/2020 15:50	08/12/2020 12:42	08/12/2020 15:50	3,13	14	43,77	CHI
20201241718	JATAI	JT11164167	JATAI S3	08/12/2020 12:42	08/12/2020 22:05	08/12/2020 12:42	08/12/2020 22:05	9,37	114	1068,05	CHI
20201239034	GOIANIA	10020608967	GOIANIA LESTE S3	08/12/2020 12:43	08/12/2020 15:44	08/12/2020 12:43	08/12/2020 15:44	3,01	1	3,01	CHI
20201239039	ANAPOLIS	20029068	ANAPOLIS UNIVERSITARIO S2	08/12/2020 12:44	08/12/2020 15:35	08/12/2020 12:44	08/12/2020 15:35	2,84	1	2,84	CHI
20201239048	SAO JOAO D ALIANCA	FB12256442	FLORES DE GOIAS	08/12/2020 12:44	08/12/2020 20:29	08/12/2020 12:44	08/12/2020 20:29	7,75	32	247,98	CHI
20201239048	FLORES DE GOIAS	FB12256442	FLORES DE GOIAS	08/12/2020 12:44	08/12/2020 20:29	08/12/2020 12:44	08/12/2020 20:29	7,75	1	7,75	CHI
20201239338	CRIXAS	CX12202125	SERRA DO OURO	08/12/2020 12:44	08/12/2020 18:47	08/12/2020 12:44	08/12/2020 18:47	6,04	3	18,12	CHI
20201240085	GAMELEIRA DE GOIAS	SV12056335	DAIA S2	08/12/2020 12:44	08/12/2020 16:32	08/12/2020 12:44	08/12/2020 16:32	3,79	7	26,51	CHI
20201239045	JATAI	JT21131224	JATAI S1	08/12/2020 12:45	09/12/2020 00:55	08/12/2020 12:45	09/12/2020 00:55	12,16	1	12,16	CHI
20201239046	CATALAO	IP21157427	IPAMERI	08/12/2020 12:45	08/12/2020 13:28	08/12/2020 12:45	08/12/2020 13:28	0,70	1	0,70	CHI
20201239047	JATAI	JT21191689	JATAI S1	08/12/2020 12:47	09/12/2020 01:16	08/12/2020 12:47	09/12/2020 01:16	12,48	1	12,48	CHI
20201239049	MUNDO NOVO DE GOIAS	MH11216321	NOVA CRIXAS	08/12/2020 12:47	08/12/2020 13:45	08/12/2020 12:47	08/12/2020 13:45	0,96	38	36,41	CHI
20201239383	CUMARI	CT12011258	CATALAO S2	08/12/2020 12:47	08/12/2020 15:51	08/12/2020 12:47	08/12/2020 15:51	3,06	24	73,33	CHI
20201239383	GOIANDIRA	CT12011258	CATALAO S2	08/12/2020 12:47	08/12/2020 15:51	08/12/2020 12:47	08/12/2020 15:51	3,06	4	12,22	CHI
20201239053	CORUMBAIBA	CI21180477	VILA CORUMBA	08/12/2020 12:48	08/12/2020 20:17	08/12/2020 12:48	08/12/2020 20:17	7,47	1	7,47	CHI
20201239054	MINEIROS	MY12306480	PARQUE DAS EMAS	08/12/2020 12:49	08/12/2020 14:06	08/12/2020 12:49	08/12/2020 14:06	1,28	1	1,28	CHI
20201239057	ITUMBIARA	IT21000149	PARANAIBA	08/12/2020 12:50	08/12/2020 20:39	08/12/2020 12:50	08/12/2020 20:39	7,81	1	7,81	CHI
20201239058	CORUMBA DE GOIAS	ZN21273285	COCALZINHO	08/12/2020 12:50	08/12/2020 17:01	08/12/2020 12:50	08/12/2020 17:01	4,18	1	4,18	CHI
20201239169	ALTO PARAISO DE GOIAS	BF10395392	NIQUELANDIA SUBTRANSMISSAO	08/12/2020 12:50	08/12/2020 13:17	08/12/2020 12:59	08/12/2020 13:17	0,30	546	163,95	CHI
20201239436	JAUPACI	JP12354611	IPORA	08/12/2020 12:50	08/12/2020 17:20	08/12/2020 12:50	08/12/2020 17:20	4,49	8	35,95	CHI
2020120800138	FORMOSA	49201	SAO JOAO D ALIANCA	08/12/2020 12:52	08/12/2020 12:57	08/12/2020 12:52	08/12/2020 12:57	0,08	551	45,92	CHI
2020120800138	FORMOSA	49202	SAO JOAO D ALIANCA	08/12/2020 12:52	08/12/2020 12:57	08/12/2020 12:52	08/12/2020 12:57	0,08	508	42,33	CHI
2020120800138	FORMOSA	02160414	SAO JOAO D ALIANCA	08/12/2020 12:52	08/12/2020 12:57	08/12/2020 12:52	08/12/2020 12:57	0,08	3	0,25	CHI
2020120800138	FLANALTINA	02160414	SAO JOAO D ALIANCA	08/12/2020 12:52	08/12/2020 12:57	08/12/2020 12:52	08/12/2020 12:57	0,08	293	24,42	CHI
2020120800138	FLORES DE GOIAS	49201	SAO JOAO D ALIANCA	08/12/2020 12:52	08/12/2020 12:57	08/12/2020 12:52	08/12/2020 12:57	0,08	7	0,58	CHI
2020120800138	AGUA FRIA DE GOIAS	02160414	SAO JOAO D ALIANCA	08/12/2020 12:52	08/12/2020 12:57	08/12/2020 12:52	08/12/2020 12:57	0,08	2124	177,00	CHI
2020120800138	SAO JOAO D ALIANCA	49201	SAO JOAO D ALIANCA	08/12/2020 12:52	08/12/2020 12:57	08/12/2020 12:52	08/12/2020 12:57	0,08	51	4,25	CHI
2020120800138	MIMOSO DE GOIAS	02160414	SAO JOAO D ALIANCA	08/12/2020 12:52	08/12/2020 12:57	08/12/2020 12:52	08/12/2020 12:57	0,08	30	2,50	CHI
2020120800138	SAO JOAO D ALIANCA	02160414	SAO JOAO D ALIANCA	08/12/2020 12:52	08/12/2020 12:57	08/12/2020 12:52	08/12/2020 12:57	0,08	28	2,33	CHI

20201239077	GOIANIA	GN11086124	FERROVIARIO S3	08/12/2020 12:53	08/12/2020 15:47	08/12/2020 14:17	08/12/2020 15:47	1,50	71	106,50	CHI
20201239107	SAO JOAO D ALIANCA	02160434	SAO JOAO D ALIANCA	08/12/2020 12:54	11/12/2020 20:38	08/12/2020 12:54	09/12/2020 01:18	12,41	3	37,23	CHI
20201239107	AGUA FRIA DE GOIAS	02160434	SAO JOAO D ALIANCA	08/12/2020 12:54	11/12/2020 20:38	08/12/2020 12:54	09/12/2020 07:27	18,55	2	37,10	CHI
20201239107	SAO JOAO D ALIANCA	02160434	SAO JOAO D ALIANCA	08/12/2020 12:54	11/12/2020 20:38	08/12/2020 12:54	09/12/2020 07:27	18,55	8	148,40	CHI
20201239107	AGUA FRIA DE GOIAS	02160434	SAO JOAO D ALIANCA	08/12/2020 12:54	11/12/2020 20:38	09/12/2020 08:30	09/12/2020 08:56	0,43	2	0,86	CHI
20201239107	SAO JOAO D ALIANCA	02160434	SAO JOAO D ALIANCA	08/12/2020 12:54	11/12/2020 20:38	09/12/2020 08:30	09/12/2020 08:56	0,43	11	4,73	CHI
20201239107	NIQUELANDIA	TL13270104	SAO JOAO D ALIANCA	08/12/2020 12:54	11/12/2020 20:38	08/12/2020 12:54	09/12/2020 11:36	22,71	3	68,13	CHI
20201239107	AGUA FRIA DE GOIAS	TL13270104	SAO JOAO D ALIANCA	08/12/2020 12:54	11/12/2020 20:38	08/12/2020 12:54	09/12/2020 11:36	22,71	13	295,22	CHI
20201239107	SAO JOAO D ALIANCA	TL13270104	SAO JOAO D ALIANCA	08/12/2020 12:54	11/12/2020 20:38	08/12/2020 12:54	09/12/2020 11:36	22,71	112	2543,46	CHI
20201239107	AGUA FRIA DE GOIAS	TL13270104	SAO JOAO D ALIANCA	08/12/2020 12:54	11/12/2020 20:38	09/12/2020 08:30	09/12/2020 11:36	3,11	1	3,11	CHI
20201239107	SAO JOAO D ALIANCA	TL13270104	SAO JOAO D ALIANCA	08/12/2020 12:54	11/12/2020 20:38	09/12/2020 08:30	09/12/2020 11:36	3,11	1	3,11	CHI
20201239107	SAO JOAO D ALIANCA	02160434	SAO JOAO D ALIANCA	08/12/2020 12:54	11/12/2020 20:38	09/12/2020 12:31	09/12/2020 14:03	1,54	11	16,91	CHI
20201239107	AGUA FRIA DE GOIAS	02160434	SAO JOAO D ALIANCA	08/12/2020 12:54	11/12/2020 20:38	09/12/2020 12:31	09/12/2020 14:03	1,54	2	3,07	CHI
20201239107	AGUA FRIA DE GOIAS	02160434	SAO JOAO D ALIANCA	08/12/2020 12:54	11/12/2020 20:38	09/12/2020 14:06	09/12/2020 14:10	0,06	2	0,13	CHI
20201239107	SAO JOAO D ALIANCA	02160434	SAO JOAO D ALIANCA	08/12/2020 12:54	11/12/2020 20:38	09/12/2020 14:06	09/12/2020 14:10	0,06	11	0,70	CHI
20201239107	AGUA FRIA DE GOIAS	02160434	SAO JOAO D ALIANCA	08/12/2020 12:54	11/12/2020 20:38	09/12/2020 12:31	09/12/2020 16:28	3,94	7	27,59	CHI
20201239107	SAO JOAO D ALIANCA	02160434	SAO JOAO D ALIANCA	08/12/2020 12:54	11/12/2020 20:38	09/12/2020 12:31	09/12/2020 16:28	3,94	109	429,64	CHI
20201239107	SAO JOAO D ALIANCA	02160434	SAO JOAO D ALIANCA	08/12/2020 12:54	11/12/2020 20:38	10/12/2020 13:17	10/12/2020 13:46	0,49	120	59,30	CHI
20201239107	AGUA FRIA DE GOIAS	02160434	SAO JOAO D ALIANCA	08/12/2020 12:54	11/12/2020 20:38	10/12/2020 13:17	10/12/2020 13:46	0,49	9	4,45	CHI
20201239107	AGUA FRIA DE GOIAS	02160434	SAO JOAO D ALIANCA	08/12/2020 12:54	11/12/2020 20:38	09/12/2020 12:31	10/12/2020 15:11	26,66	2	53,32	CHI
20201239107	AGUA FRIA DE GOIAS	02160434	SAO JOAO D ALIANCA	08/12/2020 12:54	11/12/2020 20:38	10/12/2020 18:50	10/12/2020 19:27	0,62	11	6,84	CHI
20201239107	SAO JOAO D ALIANCA	02160434	SAO JOAO D ALIANCA	08/12/2020 12:54	11/12/2020 20:38	10/12/2020 18:50	10/12/2020 19:27	0,62	120	74,60	CHI
20201239107	AGUA FRIA DE GOIAS	02160434	SAO JOAO D ALIANCA	08/12/2020 12:54	11/12/2020 20:38	11/12/2020 08:27	11/12/2020 09:00	0,54	11	5,98	CHI
20201239107	SAO JOAO D ALIANCA	02160434	SAO JOAO D ALIANCA	08/12/2020 12:54	11/12/2020 20:38	11/12/2020 08:27	11/12/2020 09:00	0,54	120	65,27	CHI
20201239107	SAO JOAO D ALIANCA	02160434	SAO JOAO D ALIANCA	08/12/2020 12:54	11/12/2020 20:38	09/12/2020 12:31	11/12/2020 14:57	50,43	4	201,70	CHI
20201239107	AGUA FRIA DE GOIAS	02160434	SAO JOAO D ALIANCA	08/12/2020 12:54	11/12/2020 20:38	09/12/2020 12:31	11/12/2020 14:57	50,43	5	252,13	CHI
20201239107	NIQUELANDIA	02160434	SAO JOAO D ALIANCA	08/12/2020 12:54	11/12/2020 20:38	09/12/2020 12:31	11/12/2020 14:57	50,43	3	151,28	CHI
20201239107	SAO JOAO D ALIANCA	02160434	SAO JOAO D ALIANCA	08/12/2020 12:54	11/12/2020 20:38	11/12/2020 16:51	11/12/2020 18:42	1,83	124	227,44	CHI
20201239107	AGUA FRIA DE GOIAS	02160434	SAO JOAO D ALIANCA	08/12/2020 12:54	11/12/2020 20:38	11/12/2020 16:51	11/12/2020 18:42	1,83	16	29,35	CHI
20201239107	NIQUELANDIA	02160434	SAO JOAO D ALIANCA	08/12/2020 12:54	11/12/2020 20:38	11/12/2020 16:51	11/12/2020 18:42	1,83	3	5,50	CHI
20201239107	NIQUELANDIA	TL13270104	SAO JOAO D ALIANCA	08/12/2020 12:54	11/12/2020 20:38	08/12/2020 12:54	11/12/2020 19:10	78,27	60	4696,48	CHI
20201239107	AGUA FRIA DE GOIAS	TL13270104	SAO JOAO D ALIANCA	08/12/2020 12:54	11/12/2020 20:38	08/12/2020 12:54	11/12/2020 19:10	78,27	3	234,82	CHI
20201239107	NIQUELANDIA	TL13270104	SAO JOAO D ALIANCA	08/12/2020 12:54	11/12/2020 20:38	08/12/2020 12:54	11/12/2020 19:59	79,09	92	7276,18	CHI
20201239107	AGUA FRIA DE GOIAS	TL13270104	SAO JOAO D ALIANCA	08/12/2020 12:54	11/12/2020 20:38	08/12/2020 12:54	11/12/2020 19:59	79,09	71	5615,31	CHI
20201239107	NIQUELANDIA	TL13270105	SAO JOAO D ALIANCA	08/12/2020 12:54	11/12/2020 20:38	09/12/2020 08:30	11/12/2020 19:59	59,49	1	59,49	CHI
20201239107	NIQUELANDIA	TL13270104	SAO JOAO D ALIANCA	08/12/2020 12:54	11/12/2020 20:38	08/12/2020 12:54	11/12/2020 20:38	79,74	60	4784,60	CHI
20201239319	FORMOSA	FA12395983	FLORES DE GOIAS	08/12/2020 12:54	08/12/2020 19:22	08/12/2020 12:54	08/12/2020 19:22	6,46	99	639,76	CHI
20201240478	SITIO D ABADIA	FB12285685	IACIARA S2	08/12/2020 12:55	09/12/2020 13:11	08/12/2020 12:55	09/12/2020 13:11	24,26	71	1722,14	CHI
20201239088	CRISTALINA	KR21152357	PAMPONA	08/12/2020 12:56	08/12/2020 16:50	08/12/2020 12:56	08/12/2020 16:50	3,90	1	3,90	CHI
20201239089	TRINDADE	40319570	TRINDADE	08/12/2020 12:56	08/12/2020 14:52	08/12/2020 12:56	08/12/2020 14:52	1,93	1	1,93	CHI
20201239092	EDEIA	EA21084024	EDEIA	08/12/2020 12:57	08/12/2020 17:00	08/12/2020 12:57	08/12/2020 17:00	4,04	1	4,04	CHI
20201239093	RIO VERDE	RV11295124	RIO VERDE S1	08/12/2020 12:57	08/12/2020 14:04	08/12/2020 12:57	08/12/2020 14:04	1,10	103	113,44	CHI
20201239094	TERESINA DE GOIAS	TE11276880	FLORES DE GOIAS	08/12/2020 12:58	08/12/2020 15:30	08/12/2020 12:58	08/12/2020 15:30	2,53	1	2,53	CHI
20201239885	CAMPOS BELOS	CH12000001	SAO DOMINGOS	08/12/2020 12:58	08/12/2020 16:53	08/12/2020 12:58	08/12/2020 16:53	3,90	44	171,78	CHI
20201239098	FORMOSA	FA11397182	SAO JOAO D ALIANCA	08/12/2020 12:59	08/12/2020 18:37	08/12/2020 12:59	08/12/2020 18:37	5,63	1	5,63	CHI
20201239102	QUIRINOPOLIS	QI12000060	QUIRINOPOLIS	08/12/2020 12:59	08/12/2020 17:20	08/12/2020 12:59	08/12/2020 17:20	4,34	7	30,35	CHI
20201239111	URUACU	UR21050054	URUACU	08/12/2020 13:01	08/12/2020 16:13	08/12/2020 13:01	08/12/2020 16:13	3,19	1	3,19	CHI
20201239112	AMORINOPOLIS	AM21333173	IPORA	08/12/2020 13:01	09/12/2020 01:15	08/12/2020 13:01	09/12/2020 01:15	12,22	1	12,22	CHI
20201239136	CAMPO LIMPO	AN21381636	NEROPOLIS S1	08/12/2020 13:04	08/12/2020 14:12	08/12/2020 13:04	08/12/2020 14:12	1,13	2	2,26	CHI
20201239143	ANAPOLIS	10030050870	DAIA S1	08/12/2020 13:05	08/12/2020 17:31	08/12/2020 13:05	08/12/2020 17:31	4,43	1	4,43	CHI
20201239145	COLINAS DO SUL	TI12155523RE	MINACU	08/12/2020 13:06	08/12/2020 22:20	08/12/2020 13:06	08/12/2020 22:20	9,23	18	166,17	CHI

20201240932	FAZENDA NOVA	FN12013300	FIRMINOPOLIS S2	08/12/2020 14:45	08/12/2020 19:09	08/12/2020 14:45	08/12/2020 19:09	4,40	9	39,57	CHI
20201241330	MUNDO NOVO DE GOIAS	MH12084354	NOVA CRIXAS	08/12/2020 14:45	09/12/2020 05:05	08/12/2020 14:45	09/12/2020 05:05	14,33	6	86,00	CHI
20201239944	GOIATUBA	CL12305936	RIO DOS BOIS	08/12/2020 14:46	09/12/2020 16:47	08/12/2020 14:46	09/12/2020 16:47	26,02	2	52,03	CHI
20201240359	RIO VERDE	RV12031857	CABRIUVA S1	08/12/2020 14:46	10/12/2020 04:46	08/12/2020 14:46	09/12/2020 16:34	25,79	3	77,38	CHI
20201240359	RIO VERDE	RV12031857	CABRIUVA S1	08/12/2020 14:46	10/12/2020 04:46	08/12/2020 14:46	10/12/2020 04:46	38,00	6	228,00	CHI
20201243899	SAO LUIS DE MONTES BELOS	SL12019284	SAO LUIZ DOS MONTES BELOS	08/12/2020 14:46	09/12/2020 00:07	08/12/2020 14:46	09/12/2020 00:07	9,34	58	541,59	CHI
20201243899	SANCLERLANDIA	SL12019284	SAO LUIZ DOS MONTES BELOS	08/12/2020 14:46	09/12/2020 00:07	08/12/2020 14:46	09/12/2020 00:07	9,34	27	252,12	CHI
20201239963	GOIANIA	GN11028136	AEROPORTO S2	08/12/2020 14:47	08/12/2020 17:51	08/12/2020 14:47	08/12/2020 17:51	3,05	39	119,13	CHI
20201239964	COLINAS DO SUL	TI12266452	MINACU	08/12/2020 14:47	09/12/2020 02:21	08/12/2020 14:47	09/12/2020 02:21	11,55	6	69,33	CHI
20201241492	GOIATUBA	CL12349482	RIO DOS BOIS	08/12/2020 14:47	09/12/2020 23:42	08/12/2020 14:47	09/12/2020 23:42	32,91	7	230,35	CHI
20201241492	PORTEIRAO	CL12349482	RIO DOS BOIS	08/12/2020 14:47	09/12/2020 23:42	08/12/2020 14:47	09/12/2020 23:42	32,91	1	32,91	CHI
20201239969	PALMINOPOLIS	PP12007690	PALMEIRAS	08/12/2020 14:48	08/12/2020 18:27	08/12/2020 14:48	08/12/2020 18:27	3,65	3	10,94	CHI
20201239978	GOIANIA	GN11077024	FERROVIARIO S3	08/12/2020 14:48	09/12/2020 03:21	08/12/2020 19:30	09/12/2020 03:21	7,85	48	376,80	CHI
20201242675	GOIANIA	GN11050964	MEIA PONTE	08/12/2020 14:48	08/12/2020 21:25	08/12/2020 14:48	08/12/2020 21:25	6,61	72	476,08	CHI
20201240031	FAZENDA NOVA	FN12040966	JUSSARA	08/12/2020 14:49	08/12/2020 17:07	08/12/2020 14:49	08/12/2020 17:07	2,30	11	25,28	CHI
20201242816	SAO JOAO D ALIANCA	JL12106845	SAO JOAO D ALIANCA	08/12/2020 14:49	09/12/2020 15:25	08/12/2020 14:49	09/12/2020 15:25	24,59	15	368,85	CHI
20201239994	VALPARAISO DE GOIAS	VA12395219	PACAEMBU S2	08/12/2020 14:50	08/12/2020 18:27	08/12/2020 14:50	08/12/2020 18:27	3,61	18	65,04	CHI
20201239996	LUZIANIA	10007383310	RIO VERMELHO	08/12/2020 14:50	08/12/2020 15:34	08/12/2020 14:50	08/12/2020 15:34	0,73	1	0,73	CHI
20201240011	BELA VISTA DE GOIAS	SW12182558	CEPAIGO S2	08/12/2020 14:51	08/12/2020 16:46	08/12/2020 14:51	08/12/2020 16:46	1,90	146	277,68	CHI
20201240239	FORMOSA	O3740214	ITIQUEIRA	08/12/2020 14:51	08/12/2020 17:26	08/12/2020 14:57	08/12/2020 15:00	0,05	924	49,28	CHI
20201240239	FORMOSA	FA10400694	ITIQUEIRA	08/12/2020 14:51	08/12/2020 17:26	08/12/2020 14:57	08/12/2020 15:00	0,05	15	0,80	CHI
20201240239	FORMOSA	FA16408144	ITIQUEIRA	08/12/2020 14:51	08/12/2020 17:26	08/12/2020 14:57	08/12/2020 15:02	0,08	924	77,26	CHI
20201240239	FORMOSA	FA16408144	ITIQUEIRA	08/12/2020 14:51	08/12/2020 17:26	08/12/2020 14:57	08/12/2020 15:02	0,09	2257	201,25	CHI
20201240239	FORMOSA	FA16408144	ITIQUEIRA	08/12/2020 14:51	08/12/2020 17:26	08/12/2020 14:57	08/12/2020 15:04	0,12	1090	128,07	CHI
20201240239	FORMOSA	FA16408144	ITIQUEIRA	08/12/2020 14:51	08/12/2020 17:26	08/12/2020 14:57	08/12/2020 15:04	0,13	232	29,77	CHI
20201240239	FORMOSA	FA16408144	ITIQUEIRA	08/12/2020 14:51	08/12/2020 17:26	08/12/2020 14:57	08/12/2020 15:07	0,17	83	14,11	CHI
20201240239	FORMOSA	FA10400654	ITIQUEIRA	08/12/2020 14:51	08/12/2020 17:26	08/12/2020 14:59	08/12/2020 15:07	0,13	1	0,13	CHI
20201240239	FORMOSA	FA16408144	ITIQUEIRA	08/12/2020 14:51	08/12/2020 17:26	08/12/2020 14:57	08/12/2020 16:21	1,41	1162	1633,58	CHI
20201240239	FORMOSA	FA16408144	ITIQUEIRA	08/12/2020 14:51	08/12/2020 17:26	08/12/2020 14:57	08/12/2020 17:25	2,48	4661	11557,99	CHI
20201240239	FORMOSA	FA16408144	ITIQUEIRA	08/12/2020 14:51	08/12/2020 17:26	08/12/2020 14:57	08/12/2020 17:26	2,49	1260	3139,50	CHI
20201242392	PEROLANDIA	DP12103843LD	JATAI S1	08/12/2020 14:51	09/12/2020 00:06	08/12/2020 14:51	09/12/2020 00:06	9,24	13	120,12	CHI
20201240015	APARECIDA DO RIO DOCE	JT21033569	CACHOEIRA ALTA	08/12/2020 14:52	09/12/2020 08:26	08/12/2020 14:52	09/12/2020 08:26	17,56	1	17,56	CHI
20201240019	DOVERLANDIA	DV11204058	CAIAPONIA	08/12/2020 14:53	09/12/2020 22:30	08/12/2020 14:53	09/12/2020 22:30	31,62	2	63,23	CHI
20201240025	CATALAO	3580002178	CATALAO S1	08/12/2020 14:53	08/12/2020 19:25	08/12/2020 14:53	08/12/2020 19:25	4,52	1	4,52	CHI
20201240029	CRIXAS	CX21226891	SANTA TEREZINHA	08/12/2020 14:54	09/12/2020 10:54	08/12/2020 14:54	09/12/2020 10:54	19,99	1	19,99	CHI
20201240066	APARECIDA DO RIO DOCE	AW12189038	CACHOEIRA ALTA	08/12/2020 14:55	09/12/2020 00:47	08/12/2020 19:49	09/12/2020 00:47	4,97	20	99,34	CHI
20201240066	APARECIDA DO RIO DOCE	AW12189038	CACHOEIRA ALTA	08/12/2020 14:55	09/12/2020 00:47	08/12/2020 19:50	09/12/2020 00:47	4,95	5	24,76	CHI
20201240047	GOIANIA	14815590	CARAJAS S2	08/12/2020 14:56	08/12/2020 17:05	08/12/2020 14:56	08/12/2020 17:05	2,14	1	2,14	CHI
20201240055	BOM JESUS DE GOIAS	BJ12305420	BOM JESUS DE GOIAS	08/12/2020 14:56	08/12/2020 19:37	08/12/2020 14:56	08/12/2020 19:37	4,67	4	18,67	CHI
20201240666	AGUA FRIA DE GOIAS	TL12279981	SAO JOAO D ALIANCA	08/12/2020 14:56	09/12/2020 10:53	08/12/2020 14:56	09/12/2020 10:53	19,94	38	757,53	CHI
20201240666	AGUA FRIA DE GOIAS	TL12279981	SAO JOAO D ALIANCA	08/12/2020 14:56	09/12/2020 10:53	08/12/2020 15:01	09/12/2020 10:53	19,86	4	79,42	CHI
20201240059	MORRINHOS	GT12273783	GOIATUBA S2	08/12/2020 14:57	08/12/2020 19:30	08/12/2020 14:57	08/12/2020 19:30	4,55	3	13,64	CHI
20201240059	GOIATUBA	GT12273783	GOIATUBA S2	08/12/2020 14:57	08/12/2020 19:30	08/12/2020 14:57	08/12/2020 19:30	4,55	56	254,61	CHI
20201240142	NIQUELANDIA	20871246	URUACU	08/12/2020 14:57	09/12/2020 12:00	08/12/2020 14:57	09/12/2020 12:00	21,05	327	6883,35	CHI
20201240706	GOIANIA	GN12074231	GOIANIA LESTE S3	08/12/2020 14:57	08/12/2020 17:33	08/12/2020 14:57	08/12/2020 17:33	2,59	4	10,35	CHI
20201240575	JANDIAIA	JD21025252	PALMEIRAS	08/12/2020 14:57	09/12/2020 11:00	08/12/2020 14:57	09/12/2020 11:00	20,04	1	20,04	CHI
20201240078	SENADOR CANEDO	SW12081242	CEPAIGO S2	08/12/2020 14:58	08/12/2020 16:22	08/12/2020 14:58	08/12/2020 16:22	1,39	10	13,90	CHI
20201240183	PALMEIRAS DE GOIAS	PL12000121	PALMEIRAS	08/12/2020 14:58	08/12/2020 16:24	08/12/2020 14:58	08/12/2020 16:24	1,43	9	12,85	CHI
20201240824	GOIANIA	GN11189348	GOIANIA LESTE S1	08/12/2020 14:58	08/12/2020 18:08	08/12/2020 14:58	08/12/2020 18:08	3,16	48	151,72	CHI
20201241185	PLANALTINA	PI11048030	PLANALTINA	08/12/2020 14:58	08/12/2020 18:43	08/12/2020 14:58	08/12/2020 18:43	3,73	67	250,17	CHI
20201240089	APARECIDA DE GOIANIA	10007340247	INDEPENDENCIA S2	08/12/2020 14:59	08/12/2020 16:20	08/12/2020 14:59	08/12/2020 16:20	1,34	1	1,34	CHI

20201240092	SAO LUIS DE MONTES BELOS	SL31145896	SAO LUIZ DOS MONTES BELOS	08/12/2020 14:59	08/12/2020 16:32	08/12/2020 14:59	08/12/2020 16:32	1,54	2	3,08	CHI
20201240095	AMORINOPOLIS	AM12333099	IPORA	08/12/2020 14:59	08/12/2020 20:31	08/12/2020 14:59	08/12/2020 20:31	5,52	3	16,55	CHI
20201242910	INHUMAS	IN11012166	INHUMAS S2	08/12/2020 14:59	08/12/2020 19:33	08/12/2020 14:59	08/12/2020 19:33	4,56	92	419,80	CHI
20201240103	SAO JOAO D ALIANCA	JL12039000	SAO JOAO D ALIANCA	08/12/2020 15:00	08/12/2020 22:00	08/12/2020 15:00	08/12/2020 22:00	7,00	2	13,99	CHI
20201240687	ANICUNS	TV12382591	FIRMINOPOLIS S2	08/12/2020 15:00	08/12/2020 22:04	08/12/2020 15:00	08/12/2020 22:04	7,05	23	162,22	CHI
20201240687	TURVANIA	TV12382591	FIRMINOPOLIS S2	08/12/2020 15:00	08/12/2020 22:04	08/12/2020 15:00	08/12/2020 22:04	7,05	22	155,17	CHI
20201241880	GOIANIA	GN11126413	GOYA S2	08/12/2020 15:00	08/12/2020 20:02	08/12/2020 15:00	08/12/2020 20:02	5,02	23	115,45	CHI
20201244845	PIRENOPOLIS	PV12381210	CORUMBA	08/12/2020 15:00	09/12/2020 00:43	08/12/2020 15:00	09/12/2020 00:43	9,71	10	97,11	CHI
20201240154	ITUMBIARA	00980244	ITUMBIARA NOVA	08/12/2020 15:01	08/12/2020 18:14	08/12/2020 15:01	08/12/2020 15:43	0,71	3179	2250,03	CHI
20201240154	ITUMBIARA	IT12000302	ITUMBIARA NOVA	08/12/2020 15:01	08/12/2020 18:14	08/12/2020 15:01	08/12/2020 18:14	3,21	338	1084,70	CHI
20201240515	APARECIDA DE GOIANIA	AP16407285	INDEPENDENCIA S2	08/12/2020 15:01	09/12/2020 04:02	09/12/2020 02:58	09/12/2020 03:02	0,05	6963	359,75	CHI
20201240515	APARECIDA DE GOIANIA	AP10418872	INDEPENDENCIA S2	08/12/2020 15:01	09/12/2020 04:02	08/12/2020 15:01	09/12/2020 04:02	13,03	1124	14646,03	CHI
20201241213	PIRACANJUBA	PJ12320293	PIRACANJUBA	08/12/2020 15:01	09/12/2020 14:49	08/12/2020 15:01	09/12/2020 14:49	23,80	10	237,99	CHI
20201240150	SAO LUIS DE MONTES BELOS	SL11377168	SAO LUIZ DOS MONTES BELOS	08/12/2020 15:03	08/12/2020 19:54	08/12/2020 15:03	08/12/2020 19:54	4,83	46	222,35	CHI
20201240207	MOSSAMEDES	8656227	ITABERAI S2	08/12/2020 15:03	09/12/2020 10:16	08/12/2020 15:03	08/12/2020 23:27	8,40	9	75,62	CHI
20201240207	MOSSAMEDES	MD12089247	ITABERAI S2	08/12/2020 15:03	09/12/2020 10:16	08/12/2020 15:03	09/12/2020 08:59	17,93	4	71,73	CHI
20201240207	MOSSAMEDES	MD12089244	ITABERAI S2	08/12/2020 15:03	09/12/2020 10:16	08/12/2020 15:03	09/12/2020 10:16	19,22	15	288,25	CHI
20201240288	NEROPOLIS	NR11187232	NEROPOLIS S2	08/12/2020 15:03	08/12/2020 21:56	08/12/2020 15:03	08/12/2020 21:56	6,88	68	468,03	CHI
20201240153	CRISTALINA	KR12170316	PAMPLONA	08/12/2020 15:04	08/12/2020 20:06	08/12/2020 15:04	08/12/2020 20:06	5,04	1	5,04	CHI
20201240158	CRIXAS	NA12294705	NOVA CRIXAS	08/12/2020 15:04	09/12/2020 10:28	08/12/2020 15:04	09/12/2020 10:28	19,39	2	38,77	CHI
20201240161	LUZIANIA	120288898	RIO VERMELHO	08/12/2020 15:04	08/12/2020 20:02	08/12/2020 15:04	08/12/2020 20:02	4,95	1	4,95	CHI
20201240169	TRINDADE	TR12071529RE	TRINDADE	08/12/2020 15:05	08/12/2020 23:54	08/12/2020 15:05	08/12/2020 23:54	8,81	75	660,83	CHI
20201240655	GOIANIA	GN11162088	GOYA S2	08/12/2020 15:05	09/12/2020 01:08	08/12/2020 15:05	09/12/2020 01:08	10,04	100	1004,11	CHI
20201241395	RIO VERDE	RV12205429RE	MONTIVIDIU T	08/12/2020 15:05	09/12/2020 09:49	08/12/2020 15:05	09/12/2020 09:49	18,73	26	487,05	CHI
20201240180	SENADOR CANEDO	SW12092633LD	SENADOR CANEDO	08/12/2020 15:06	08/12/2020 17:22	08/12/2020 15:06	08/12/2020 17:22	2,26	20	45,24	CHI
20201240185	SANTA BARBARA DE GOIAS	AV12241071	ANICUNS	08/12/2020 15:06	08/12/2020 23:30	08/12/2020 15:06	08/12/2020 23:30	8,39	8	67,16	CHI
20201240185	AVELINOPOLIS	AV12241071	ANICUNS	08/12/2020 15:06	08/12/2020 23:30	08/12/2020 15:06	08/12/2020 23:30	8,39	128	1074,52	CHI
20201240247	GOIANIA	GN11035481	ATLANTICO S2	08/12/2020 15:06	08/12/2020 19:03	08/12/2020 15:06	08/12/2020 19:03	3,93	218	857,65	CHI
20201240191	LUZIANIA	LZ21245543	VIANOPOLIS	08/12/2020 15:07	09/12/2020 18:45	08/12/2020 15:07	09/12/2020 18:45	27,65	1	27,65	CHI
20201240656	BELA VISTA DE GOIAS	SV12012134	BELA VISTA S2	08/12/2020 15:07	09/12/2020 12:51	08/12/2020 15:07	09/12/2020 12:51	21,72	25	543,01	CHI
20201240209	GOIANIA	11190280	FERROVIARIO S1	08/12/2020 15:08	08/12/2020 18:24	08/12/2020 15:08	08/12/2020 18:24	3,26	1	3,26	CHI
20201240214	CATURAI	CK21246885	ARACU	08/12/2020 15:08	08/12/2020 18:14	08/12/2020 15:08	08/12/2020 18:14	3,09	1	3,09	CHI
20201240249	QUIRINOPOLIS	QI12296545	QUIRINOPOLIS	08/12/2020 15:08	08/12/2020 20:05	08/12/2020 15:08	08/12/2020 20:05	4,95	2	9,90	CHI
20201240227	SANTA HELENA DE GOIAS	SH21283196	IPEGUARI	08/12/2020 15:09	09/12/2020 01:46	08/12/2020 15:09	09/12/2020 01:46	10,61	1	10,61	CHI
20201240228	PLANALTINA	PI12071309	PLANALTINA	08/12/2020 15:09	08/12/2020 17:12	08/12/2020 15:09	08/12/2020 17:12	2,04	39	79,60	CHI
20201240280	BELA VISTA DE GOIAS	BV32249964	BELA VISTA S1	08/12/2020 15:09	08/12/2020 17:26	08/12/2020 15:09	08/12/2020 17:26	2,28	72	164,18	CHI
20201240246	MONTE ALEGRE DE GOIAS	MA11333029	SAO DOMINGOS	08/12/2020 15:10	08/12/2020 20:30	08/12/2020 15:10	08/12/2020 20:30	5,32	3	15,96	CHI
20201242740	FORMOSA	FA11257637	ITUIQUIRA	08/12/2020 15:10	08/12/2020 21:07	08/12/2020 15:10	08/12/2020 21:07	5,94	112	665,72	CHI
20201240252	APARECIDA DE GOIANIA	AP11004913	INDEPENDENCIA S2	08/12/2020 15:11	08/12/2020 22:11	08/12/2020 15:11	08/12/2020 22:11	7,00	83	580,75	CHI
20201240252	APARECIDA DE GOIANIA	AP11167885	INDEPENDENCIA S2	08/12/2020 15:11	08/12/2020 22:11	08/12/2020 20:39	08/12/2020 22:11	1,53	71	108,71	CHI
20201240254	PALMEIRAS DE GOIAS	PL12000008	ANICUNS	08/12/2020 15:11	08/12/2020 17:50	08/12/2020 15:11	08/12/2020 17:50	2,64	58	153,14	CHI
20201240254	NAZARIO	PL12000008	ANICUNS	08/12/2020 15:11	08/12/2020 17:50	08/12/2020 15:11	08/12/2020 17:50	2,64	3	7,92	CHI
20201240263	RIO VERDE	RV21338527	CABRIUVA S2	08/12/2020 15:12	09/12/2020 11:38	08/12/2020 15:12	09/12/2020 11:38	20,43	1	20,43	CHI
20201240265	FORMOSA	FA11139693	ITUIQUIRA	08/12/2020 15:12	09/12/2020 09:14	08/12/2020 15:12	09/12/2020 09:14	18,02	17	306,36	CHI
20201240488	JUSSARA	RN12072191	BRITANIA	08/12/2020 15:12	08/12/2020 16:15	08/12/2020 15:12	08/12/2020 16:15	1,04	4	4,15	CHI
20201240488	SANTA FE DE GOIAS	RN12072191	BRITANIA	08/12/2020 15:12	08/12/2020 16:15	08/12/2020 15:12	08/12/2020 16:15	1,04	11	11,42	CHI
20201240546	MONTE ALEGRE DE GOIAS	MA12212608	SAO DOMINGOS	08/12/2020 15:12	08/12/2020 17:43	08/12/2020 15:12	08/12/2020 17:43	2,51	55	138,29	CHI
20201242834	SAO JOAO D ALIANCA	JL12146226	SAO JOAO D ALIANCA	08/12/2020 15:12	09/12/2020 12:03	08/12/2020 15:12	09/12/2020 12:03	20,85	71	1480,23	CHI
20201240375	GOIANIA	NR12000031	NEROPOLIS S2	08/12/2020 15:13	09/12/2020 15:00	08/12/2020 15:13	08/12/2020 22:19	7,09	21	148,95	CHI
20201240375	NEROPOLIS	NR12000031	NEROPOLIS S2	08/12/2020 15:13	09/12/2020 15:00	08/12/2020 15:13	08/12/2020 22:19	7,09	9	63,83	CHI
20201240375	NEROPOLIS	NR12000031	NEROPOLIS S2	08/12/2020 15:13	09/12/2020 15:00	08/12/2020 15:13	09/12/2020 15:00	23,77	10	237,74	CHI

20201240375	NEROPOLIS	NR12000031	NEROPOLIS S2	08/12/2020 15:13	09/12/2020 15:00	09/12/2020 12:30	09/12/2020 15:00	2,50	9	22,50	CHI
20201240375	GOIANIA	NR12000031	NEROPOLIS S2	08/12/2020 15:13	09/12/2020 15:00	09/12/2020 12:30	09/12/2020 15:00	2,50	21	52,50	CHI
20201240289	MORRINHOS	GT12052886	GOIATUBA S1	08/12/2020 15:15	08/12/2020 18:14	08/12/2020 15:15	08/12/2020 18:14	2,98	8	23,86	CHI
20201240293	HIDROLANDIA	HD21058051	INDEPENDENCIA S1	08/12/2020 15:15	09/12/2020 09:23	08/12/2020 15:15	09/12/2020 09:23	18,13	3	54,38	CHI
20201240300	AGUA FRIA DE GOIAS	TL12131760	SAO JOAO D ALIANCA	08/12/2020 15:15	08/12/2020 20:58	08/12/2020 15:15	08/12/2020 20:58	5,71	19	108,44	CHI
20201240300	FORMOSA	TL12131760	SAO JOAO D ALIANCA	08/12/2020 15:15	08/12/2020 20:58	08/12/2020 15:15	08/12/2020 20:58	5,71	1	5,71	CHI
20201240301	SENADOR CANEDO	SW21402859	GOIANIA LESTE S2	08/12/2020 15:15	08/12/2020 17:44	08/12/2020 15:15	08/12/2020 17:44	2,47	1	2,47	CHI
20201240381	GOIANIA	00610284	CAMPINAS S2	08/12/2020 15:15	08/12/2020 15:22	08/12/2020 15:15	08/12/2020 15:22	0,12	524	61,86	CHI
20201240537	SERRANOPOLIS	SX12296496	JATAI S1	08/12/2020 15:15	08/12/2020 17:44	08/12/2020 15:15	08/12/2020 17:44	2,48	139	344,99	CHI
20201240314	CAIAPONIA	930029173	CAIAPONIA	08/12/2020 15:17	08/12/2020 17:50	08/12/2020 15:17	08/12/2020 17:50	2,54	1	2,54	CHI
20201241452	CRIXAS	CX12248286	SERRA DO OURO	08/12/2020 15:18	08/12/2020 17:51	08/12/2020 15:18	08/12/2020 17:51	2,55	17	43,43	CHI
20201240338	GOIAS	90053655	GOIAS	08/12/2020 15:19	08/12/2020 17:19	08/12/2020 15:19	08/12/2020 17:19	1,99	1	1,99	CHI
20201240542	MINEIROS	MY12360762LD	PARQUE DAS EMAS	08/12/2020 15:19	08/12/2020 18:38	08/12/2020 15:19	08/12/2020 18:38	3,30	32	105,74	CHI
20201240353	PORTELANDIA	PW21209829	PARQUE DAS EMAS	08/12/2020 15:20	08/12/2020 16:34	08/12/2020 15:20	08/12/2020 16:34	1,22	1	1,22	CHI
20201240390	PROFESSOR JAMIL SAFADY	PJ10375764	PIRACANJUBA	08/12/2020 15:21	08/12/2020 17:09	08/12/2020 15:21	08/12/2020 17:09	1,79	3	5,38	CHI
20201240390	PIRACANJUBA	PJ10375764	PIRACANJUBA	08/12/2020 15:21	08/12/2020 17:09	08/12/2020 15:21	08/12/2020 17:09	1,79	311	557,55	CHI
20201240490	APARECIDA DE GOIANIA	AP11378289	INDEPENDENCIA S2	08/12/2020 15:21	08/12/2020 20:52	08/12/2020 15:21	08/12/2020 20:52	5,51	189	1042,12	CHI
20201240877	HIDROLANDIA	HD12400528	CEPAIGO S1	08/12/2020 15:21	09/12/2020 02:56	08/12/2020 15:21	09/12/2020 02:56	11,57	67	775,41	CHI
20201240370	ANICUNS	910050820	ANICUNS	08/12/2020 15:22	09/12/2020 07:05	08/12/2020 15:22	09/12/2020 07:05	15,71	1	15,71	CHI
20201240385	MINEIROS	MY21322106	PARQUE DAS EMAS	08/12/2020 15:24	09/12/2020 00:29	08/12/2020 15:24	09/12/2020 00:29	9,08	1	9,08	CHI
20201240404	JANDAIA	JD12377185	PALMEIRAS	08/12/2020 15:24	09/12/2020 17:21	08/12/2020 15:24	08/12/2020 18:16	2,86	3	8,57	CHI
20201240404	JANDAIA	JD12377185	PALMEIRAS	08/12/2020 15:24	09/12/2020 17:21	08/12/2020 15:24	09/12/2020 16:44	25,33	8	202,64	CHI
20201240404	JANDAIA	JD12377185	PALMEIRAS	08/12/2020 15:24	09/12/2020 17:21	08/12/2020 15:24	09/12/2020 17:21	25,95	2	51,90	CHI
20201240423	SANTA HELENA DE GOIAS	05770214	IPEGUARI	08/12/2020 15:24	09/12/2020 02:25	08/12/2020 15:26	09/12/2020 02:25	10,99	5	54,96	CHI
20201240405	PALMINOPOLIS	PP12233536	PALMEIRAS	08/12/2020 15:26	08/12/2020 16:55	08/12/2020 15:26	08/12/2020 16:55	1,48	1	1,48	CHI
20201240405	PALMEIRAS DE GOIAS	PP12233536	PALMEIRAS	08/12/2020 15:26	08/12/2020 16:55	08/12/2020 15:26	08/12/2020 16:55	1,48	11	16,23	CHI
20201240410	CIDADE OCIDENTAL	LZ21072629	MARAJOARA	08/12/2020 15:26	09/12/2020 13:00	08/12/2020 15:26	09/12/2020 13:00	21,55	1	21,55	CHI
20201240412	ITABERAI	50120864	ITABERAI S2	08/12/2020 15:26	09/12/2020 07:43	08/12/2020 15:26	09/12/2020 07:43	16,27	1	16,27	CHI
20201240649	ACREUNA	EU12037889	ACREUNA	08/12/2020 15:26	08/12/2020 23:34	08/12/2020 15:26	08/12/2020 23:34	8,12	12	97,41	CHI
20201243908	ARENOPOLIS	AY12103482	ARENOPOLIS	08/12/2020 15:26	08/12/2020 23:57	08/12/2020 15:26	08/12/2020 23:57	8,50	12	102,02	CHI
20201243908	DIORAMA	AY12103482	ARENOPOLIS	08/12/2020 15:26	08/12/2020 23:57	08/12/2020 15:26	08/12/2020 23:57	8,50	9	76,52	CHI
20201240418	SENADOR CANEDO	190020696	SENADOR CANEDO	08/12/2020 15:27	09/12/2020 13:29	08/12/2020 15:27	09/12/2020 13:29	22,04	1	22,04	CHI
20201240785	HIDROLANDIA	HD11000139	ANHANGUERA	08/12/2020 15:27	09/12/2020 15:01	08/12/2020 15:27	09/12/2020 15:01	23,56	60	1413,88	CHI
20201240430	RIO VERDE	10029916915	RIO VERDE S2	08/12/2020 15:28	08/12/2020 19:14	08/12/2020 15:28	08/12/2020 19:14	3,76	1	3,76	CHI
20201240432	ALTO PARAISO DE GOIAS	BF12399729	SAO JOAO D ALIANCA	08/12/2020 15:28	08/12/2020 19:43	08/12/2020 15:28	08/12/2020 19:43	4,24	3	12,72	CHI
20201240434	TRINDADE	TR11393607	TRINDADE	08/12/2020 15:28	08/12/2020 17:15	08/12/2020 15:28	08/12/2020 17:15	1,77	70	124,06	CHI
20201240453	ITAJA	IJ21392357	ITAJA S2	08/12/2020 15:30	08/12/2020 17:57	08/12/2020 15:30	08/12/2020 17:57	2,44	1	2,44	CHI
20201240456	URUACU	UR21213213	URUACU	08/12/2020 15:30	08/12/2020 17:39	08/12/2020 15:30	08/12/2020 17:39	2,14	1	2,14	CHI
20201240457	PIRACANJUBA	PJ21120808	PIRACANJUBA	08/12/2020 15:30	09/12/2020 14:12	08/12/2020 15:30	09/12/2020 14:12	22,69	1	22,69	CHI
20201240506	MINEIROS	MY12324396RE	PARQUE DAS EMAS	08/12/2020 15:30	09/12/2020 18:31	08/12/2020 15:30	09/12/2020 18:31	27,00	21	567,10	CHI
20201240825	FORMOSA	PI12361364	PLANALTINA	08/12/2020 15:30	08/12/2020 18:56	08/12/2020 15:30	08/12/2020 18:56	3,42	47	160,86	CHI
20201240477	ANAPOLIS	OV12384197	NEROPOLIS S1	08/12/2020 15:31	08/12/2020 23:45	08/12/2020 15:31	08/12/2020 23:45	8,22	5	41,10	CHI
20201240477	OURO VERDE DE GOIAS	OV12384197	NEROPOLIS S1	08/12/2020 15:31	08/12/2020 23:45	08/12/2020 15:31	08/12/2020 23:45	8,22	2	16,44	CHI
20201240774	SANTA TEREZINHA DE GOIAS	SG11000019	SANTA TEREZINHA	08/12/2020 15:31	08/12/2020 17:41	08/12/2020 15:31	08/12/2020 17:41	2,16	194	418,82	CHI
20201240918	GOIANIA	GN16407230	MEIA PONTE	08/12/2020 15:31	08/12/2020 15:35	08/12/2020 15:31	08/12/2020 15:35	0,06	3870	221,45	CHI
20201240486	ITAPURANGA	IK21188126	ITAPURANGA	08/12/2020 15:32	09/12/2020 07:24	08/12/2020 15:32	09/12/2020 07:24	15,86	2	31,72	CHI
20201240493	JATAI	JT12092386RE	JATAI S1	08/12/2020 15:33	08/12/2020 18:23	08/12/2020 15:33	08/12/2020 18:23	2,83	43	121,77	CHI
20201240493	SERRANOPOLIS	JT12092386RE	JATAI S1	08/12/2020 15:33	08/12/2020 18:23	08/12/2020 15:33	08/12/2020 18:23	2,83	3	8,50	CHI
20201240494	APARECIDA DE GOIANIA	16253050	REAL S2	08/12/2020 15:33	08/12/2020 19:09	08/12/2020 15:33	08/12/2020 19:09	3,60	1	3,60	CHI
20201240500	RIO VERDE	RV12279609	RIO VERDE S1	08/12/2020 15:33	08/12/2020 21:22	08/12/2020 15:33	08/12/2020 21:22	5,81	32	185,86	CHI
20201240501	NIQUELANDIA	NQ21342793	NIQUELANDIA SUBTRANSMISSAO	08/12/2020 15:33	09/12/2020 09:09	08/12/2020 15:33	09/12/2020 09:09	17,59	2	35,18	CHI

20201240503	TRINDADE	40200930	TRINDADE	08/12/2020 15:33	08/12/2020 23:13	08/12/2020 15:33	08/12/2020 23:13	7,66	1	7,66	CHI
20201243591	AURILANDIA	AI12000002	FIRMINOPOLIS S2	08/12/2020 15:33	10/12/2020 05:56	08/12/2020 15:33	10/12/2020 05:56	38,37	30	1151,12	CHI
20201243591	FIRMINOPOLIS	AI12000002	FIRMINOPOLIS S2	08/12/2020 15:33	10/12/2020 05:56	08/12/2020 15:33	10/12/2020 05:56	38,37	16	613,93	CHI
20201241140	SITIO D ABADIA	SI12344641	IACIARA S2	08/12/2020 15:34	08/12/2020 21:57	08/12/2020 15:34	08/12/2020 21:57	6,37	5	31,86	CHI
20201240519	GOIANIA	10719260	CAMPINAS S3	08/12/2020 15:35	08/12/2020 17:39	08/12/2020 15:35	08/12/2020 17:39	2,06	1	2,06	CHI
20201240525	LUZIANIA	10005895250	RIO VERMELHO	08/12/2020 15:35	08/12/2020 18:49	08/12/2020 15:35	08/12/2020 18:49	3,22	1	3,22	CHI
20201240940	BELA VISTA DE GOIAS	BV12035058	BELA VISTA S1	08/12/2020 15:35	08/12/2020 19:37	08/12/2020 15:35	08/12/2020 19:37	4,02	6	24,12	CHI
20201240528	PLANALTINA	PI12344175	SAO JOAO D ALIANCA	08/12/2020 15:36	09/12/2020 10:20	08/12/2020 15:36	09/12/2020 10:20	18,73	6	112,39	CHI
20201240528	PLANALTINA	PI12344175	SAO JOAO D ALIANCA	08/12/2020 15:36	09/12/2020 10:20	09/12/2020 09:48	09/12/2020 10:20	0,53	17	9,07	CHI
20201241115	IACIARA	IA11095911	IACIARA S1	08/12/2020 15:37	08/12/2020 18:14	08/12/2020 15:37	08/12/2020 18:14	2,61	181	471,71	CHI
20201240553	MONTIVIDIU DO NORTE	MX11362021	PORANGATU	08/12/2020 15:38	08/12/2020 21:19	08/12/2020 15:38	08/12/2020 21:19	5,67	1	5,67	CHI
20201240563	PADRE BERNARDO	PB12330893	PADRE BERNARDO	08/12/2020 15:39	08/12/2020 18:49	08/12/2020 15:39	08/12/2020 18:49	3,15	4	12,61	CHI
20201241631	QUIRINOPOLIS	QI32052457	QUIRINOPOLIS	08/12/2020 15:39	08/12/2020 19:02	08/12/2020 15:39	08/12/2020 19:02	3,38	9	30,39	CHI
20201241690	ITABERAI	IB21406509	ITABERAI S1	08/12/2020 15:39	09/12/2020 08:14	08/12/2020 15:39	09/12/2020 08:14	16,57	1	16,57	CHI
20201240574	MINEIROS	MY12390605RE	PARQUE DAS EMAS	08/12/2020 15:40	09/12/2020 17:45	08/12/2020 15:40	09/12/2020 17:45	26,09	16	417,36	CHI
20201240587	CACHOEIRA ALTA	CA12041706	CACHOEIRA ALTA	08/12/2020 15:40	08/12/2020 19:10	08/12/2020 15:40	08/12/2020 19:10	3,50	10	34,96	CHI
20201240887	MORRO AGUDO DE GOIAS	RB12126565	RUBIATABA	08/12/2020 15:40	08/12/2020 17:06	08/12/2020 15:40	08/12/2020 17:06	1,43	5	7,15	CHI
20201240887	RUBIATABA	RB12126565	RUBIATABA	08/12/2020 15:40	08/12/2020 17:06	08/12/2020 15:40	08/12/2020 17:06	1,43	58	82,89	CHI
20201240586	PIRENOPOLIS	PV21043091	CORUMBA	08/12/2020 15:41	09/12/2020 14:40	08/12/2020 15:41	09/12/2020 14:40	22,97	2	45,95	CHI
20201240589	CACHOEIRA ALTA	CA21365497	CACHOEIRA ALTA	08/12/2020 15:42	08/12/2020 17:32	08/12/2020 15:42	08/12/2020 17:32	1,85	1	1,85	CHI
20201240597	APARECIDA DE GOIANIA	200402171	INDEPENDENCIA S1	08/12/2020 15:43	08/12/2020 17:16	08/12/2020 15:43	08/12/2020 17:16	1,55	1	1,55	CHI
20201240606	MORRINHOS	MR21212299	MORRINHOS	08/12/2020 15:43	08/12/2020 17:03	08/12/2020 15:43	08/12/2020 17:03	1,33	1	1,33	CHI
20201240608	VIANOPOLIS	VN21072406	VIANOPOLIS	08/12/2020 15:43	08/12/2020 19:41	08/12/2020 15:43	08/12/2020 19:41	3,95	1	3,95	CHI
20201240609	RIO VERDE	630045689	RIO VERDE S1	08/12/2020 15:43	08/12/2020 22:33	08/12/2020 15:43	08/12/2020 22:33	6,82	1	6,82	CHI
20201240612	ORIZONA	OZ12114547	PIRES DO RIO S2	08/12/2020 15:43	08/12/2020 17:21	08/12/2020 15:43	08/12/2020 17:21	1,63	8	13,02	CHI
20201240612	ORIZONA	OZ12114547	PIRES DO RIO S2	08/12/2020 15:43	08/12/2020 17:21	08/12/2020 15:43	08/12/2020 17:21	1,62	1	1,62	CHI
20201240749	MINEIROS	MY12355996	PARQUE DAS EMAS	08/12/2020 15:43	08/12/2020 17:44	08/12/2020 15:43	08/12/2020 17:44	2,01	182	366,48	CHI
20201240987	ITAPIRAPUA	GS12014714	MATRINCHA	08/12/2020 15:43	09/12/2020 01:17	08/12/2020 15:43	09/12/2020 01:17	9,56	1	9,56	CHI
20201240987	GOIAS	GS12014714	MATRINCHA	08/12/2020 15:43	09/12/2020 01:17	08/12/2020 15:43	09/12/2020 01:17	9,56	162	1548,81	CHI
20201240987	NOVO BRASIL	GS12014714	MATRINCHA	08/12/2020 15:43	09/12/2020 01:17	08/12/2020 15:43	09/12/2020 01:17	9,56	36	344,18	CHI
20201240621	GOIANIA	GN12071845	GOIANIA LESTE S3	08/12/2020 15:44	08/12/2020 19:15	08/12/2020 15:44	08/12/2020 19:15	3,51	4	14,03	CHI
20201241532	PONTALINA	PK12328982	PONTALINA	08/12/2020 15:44	08/12/2020 23:30	08/12/2020 15:44	08/12/2020 23:30	7,76	8	62,09	CHI
20201240627	ORIZONA	OZ16411353	PIRES DO RIO S2	08/12/2020 15:45	09/12/2020 17:05	08/12/2020 15:45	09/12/2020 04:09	12,41	1	12,41	CHI
20201240627	VIANOPOLIS	OZ16411353	PIRES DO RIO S2	08/12/2020 15:45	09/12/2020 17:05	08/12/2020 18:31	09/12/2020 04:09	9,64	2	19,28	CHI
20201240627	ORIZONA	OZ16411353	PIRES DO RIO S2	08/12/2020 15:45	09/12/2020 17:05	08/12/2020 18:31	09/12/2020 04:09	9,64	4	38,56	CHI
20201240627	ORIZONA	OZ10400414	PIRES DO RIO S2	08/12/2020 15:45	09/12/2020 17:05	09/12/2020 04:17	09/12/2020 09:30	5,22	80	417,56	CHI
20201240627	VIANOPOLIS	OZ10400414	PIRES DO RIO S2	08/12/2020 15:45	09/12/2020 17:05	09/12/2020 04:17	09/12/2020 17:05	12,80	141	1805,11	CHI
20201240627	ORIZONA	OZ10400414	PIRES DO RIO S2	08/12/2020 15:45	09/12/2020 17:05	09/12/2020 04:17	09/12/2020 17:05	12,80	221	2829,29	CHI
20201240627	ORIZONA	OZ10400414	PIRES DO RIO S2	08/12/2020 15:45	09/12/2020 17:05	09/12/2020 09:31	09/12/2020 17:05	7,56	80	604,96	CHI
20201240634	FORMOSA	FA21107600	SAO JOAO D ALIANCA	08/12/2020 15:45	09/12/2020 17:52	08/12/2020 15:45	09/12/2020 17:52	26,10	1	26,10	CHI
20201240639	CALDAS NOVAS	BC12352288	CALDAS NOVAS S1	08/12/2020 15:46	09/12/2020 12:50	08/12/2020 15:46	09/12/2020 12:50	21,06	1	21,06	CHI
20201240646	GOIANIA	14850321	GOYA S2	08/12/2020 15:47	08/12/2020 22:30	08/12/2020 15:47	08/12/2020 22:30	6,71	1	6,71	CHI
20201240650	ABADIANIA	AA12221425	ANAPOLIS UNIVERSITARIO S1	08/12/2020 15:47	08/12/2020 17:58	08/12/2020 15:47	08/12/2020 17:58	2,17	45	97,68	CHI
20201240650	GAMELEIRA DE GOIAS	AA12221425	ANAPOLIS UNIVERSITARIO S1	08/12/2020 15:47	08/12/2020 17:58	08/12/2020 15:47	08/12/2020 17:58	2,17	1	2,17	CHI
20201240653	LUZIANIA	LZ21163245	RIO VERMELHO	08/12/2020 15:47	08/12/2020 18:04	08/12/2020 15:47	08/12/2020 18:04	2,27	4	9,07	CHI
20201243424	NIQUELANDIA	NQ11333937	NIQUELANDIA SUBTRANSMISSAO	08/12/2020 15:47	08/12/2020 21:10	08/12/2020 15:47	08/12/2020 21:10	5,37	68	365,25	CHI
20201240914	CALDAS NOVAS	CN11000028	SERRA DE CALDAS	08/12/2020 15:48	08/12/2020 17:24	08/12/2020 15:48	08/12/2020 17:24	1,58	118	187,03	CHI
20201241024	GOIANIRA	TR12015734	INHUMAS S1	08/12/2020 15:48	08/12/2020 18:12	08/12/2020 15:48	08/12/2020 18:12	2,39	16	38,32	CHI
20201241024	TRINDADE	TR12015734	INHUMAS S1	08/12/2020 15:48	08/12/2020 18:12	08/12/2020 15:48	08/12/2020 18:12	2,39	2	4,79	CHI
20201242901	MONTES CLAROS DE GOIAS	ME12212911	IPORA	08/12/2020 15:48	09/12/2020 15:33	08/12/2020 15:48	09/12/2020 15:33	23,74	37	878,29	CHI
20201240680	FAZENDA NOVA	FN11259894	JUSSARA	08/12/2020 15:49	09/12/2020 17:27	08/12/2020 15:49	09/12/2020 17:27	25,62	105	2689,90	CHI

20201241246	ITAPIRAPUA	IU12018785	MATRINCHA	08/12/2020 15:49	08/12/2020 17:30	08/12/2020 15:49	08/12/2020 17:30	1,68	83	139,35	CHI
20201242423	ARAGARCAS	AG11000010	ARAGARCAS	08/12/2020 15:49	08/12/2020 19:06	08/12/2020 15:49	08/12/2020 19:06	3,28	86	282,27	CHI
20201246877	CATURAI	CK12310220	INHUMAS S1	08/12/2020 15:49	09/12/2020 23:33	08/12/2020 15:49	09/12/2020 21:30	29,68	2	59,36	CHI
20201246877	CATURAI	CK12310220	INHUMAS S1	08/12/2020 15:49	09/12/2020 23:33	08/12/2020 15:49	09/12/2020 23:33	31,73	6	190,38	CHI
20201240685	QUIRINOPOLIS	QI21035785	QUIRINOPOLIS	08/12/2020 15:50	09/12/2020 09:31	08/12/2020 15:50	09/12/2020 09:31	17,67	1	17,67	CHI
20201240691	SAO LUIZ DO NORTE	3090000037	ITAPACI	08/12/2020 15:51	08/12/2020 21:45	08/12/2020 15:51	08/12/2020 21:45	5,90	1	5,90	CHI
20201240698	SENADOR CANEDO	SW11029462	CEPAIGO S1	08/12/2020 15:51	08/12/2020 17:20	08/12/2020 15:51	08/12/2020 17:20	1,47	17	24,94	CHI
20201246879	CATURAI	CK12018544	INHUMAS S1	08/12/2020 15:51	09/12/2020 23:33	08/12/2020 15:51	09/12/2020 19:02	27,17	12	326,02	CHI
20201246879	CATURAI	CK12018544	INHUMAS S1	08/12/2020 15:51	09/12/2020 23:33	08/12/2020 15:51	09/12/2020 23:33	31,69	11	348,54	CHI
20201249205	CAIAPONIA	CP11355610	PALESTINA	08/12/2020 15:51	09/12/2020 15:05	08/12/2020 15:51	09/12/2020 15:05	23,23	1	23,23	CHI
20201240699	MATRINCHA	MP11183366	MATRINCHA	08/12/2020 15:52	09/12/2020 01:24	08/12/2020 15:52	09/12/2020 01:24	9,53	73	695,93	CHI
20201240710	PARAUNA	CG12391526	FIRMINOPOLIS S2	08/12/2020 15:52	09/12/2020 00:14	08/12/2020 15:52	09/12/2020 00:14	8,36	30	250,65	CHI
20201240710	CACHOEIRA DE GOIAS	CG12391526	FIRMINOPOLIS S2	08/12/2020 15:52	09/12/2020 00:14	08/12/2020 15:52	09/12/2020 00:14	8,36	11	91,91	CHI
20201240710	AURILANDIA	CG12391526	FIRMINOPOLIS S2	08/12/2020 15:52	09/12/2020 00:14	08/12/2020 15:52	09/12/2020 00:14	8,36	2	16,71	CHI
20201240711	PIRANHAS	PH12201916	BOM JARDIM	08/12/2020 15:52	08/12/2020 20:21	08/12/2020 15:52	08/12/2020 20:21	4,47	9	40,21	CHI
20201241978	CATURAI	CK12376877	ARACU	08/12/2020 15:52	09/12/2020 20:31	08/12/2020 15:52	09/12/2020 20:31	28,63	3	85,90	CHI
20201240723	MONTIVIDIU DO NORTE	MX21146579	PORANGATU	08/12/2020 15:53	08/12/2020 20:49	08/12/2020 15:53	08/12/2020 20:49	4,92	1	4,92	CHI
20201240731	ITABERAI	IB12022048	ITABERAI S2	08/12/2020 15:53	08/12/2020 17:16	08/12/2020 15:53	08/12/2020 17:16	1,38	13	18,00	CHI
20201243790	CACU	CC12142036	CACHOEIRA ALTA	08/12/2020 15:53	08/12/2020 23:55	08/12/2020 15:53	08/12/2020 23:55	8,02	7	56,13	CHI
20201240745	SAO JOAO D ALIANCA	3840007420	SAO JOAO D ALIANCA	08/12/2020 15:55	09/12/2020 12:18	08/12/2020 15:55	09/12/2020 12:18	20,37	1	20,37	CHI
20201241053	SANTA CRUZ DE GOIAS	PZ11027091	PIRES DO RIO S2	08/12/2020 15:55	08/12/2020 22:43	08/12/2020 15:55	08/12/2020 22:43	6,80	72	489,56	CHI
20201242829	JATAI	IM12234538	CACHOEIRA ALTA	08/12/2020 15:55	09/12/2020 08:31	08/12/2020 15:55	09/12/2020 08:31	16,60	20	331,96	CHI
20201242829	ITARUMA	IM12234538	CACHOEIRA ALTA	08/12/2020 15:55	09/12/2020 08:31	08/12/2020 15:55	09/12/2020 08:31	16,60	36	597,53	CHI
20201242829	CACU	IM12234538	CACHOEIRA ALTA	08/12/2020 15:55	09/12/2020 08:31	08/12/2020 15:55	09/12/2020 08:31	16,60	62	1029,08	CHI
20201240792	CABECEIRAS	CW12204613	ITUIQUIRA	08/12/2020 15:59	08/12/2020 21:38	08/12/2020 15:59	08/12/2020 21:38	5,64	1	5,64	CHI
20201240798	QUIRINOPOLIS	QI21035073	QUIRINOPOLIS	08/12/2020 16:00	09/12/2020 09:26	08/12/2020 16:00	09/12/2020 09:26	17,43	1	17,43	CHI
20201240799	MINEIROS	MY12105602	PARQUE DAS EMAS	08/12/2020 16:00	08/12/2020 18:05	08/12/2020 16:00	08/12/2020 18:05	2,07	92	190,72	CHI
20201240806	CEZARINA	CZ21076517	CEZARINA	08/12/2020 16:01	09/12/2020 15:54	08/12/2020 16:01	09/12/2020 15:54	23,87	1	23,87	CHI
20201241033	MAIRIPOTABA	MI12023194	PONTALINA	08/12/2020 16:01	09/12/2020 10:11	08/12/2020 16:01	09/12/2020 10:11	18,15	4	72,62	CHI
20201240820	ANAPOLIS	AN12258922	JUNDIAI S1	08/12/2020 16:02	08/12/2020 17:42	08/12/2020 16:02	08/12/2020 17:42	1,65	17	28,07	CHI
20201240992	MUNDO NOVO DE GOIAS	MH12320885	NOVA CRIXAS	08/12/2020 16:02	08/12/2020 17:01	08/12/2020 16:02	08/12/2020 17:01	0,98	215	211,36	CHI
20201241799	SILVANIA	SV12194949	VIANOPOLIS	08/12/2020 16:02	08/12/2020 21:18	08/12/2020 16:02	08/12/2020 21:18	5,26	121	636,39	CHI
20201240826	APARECIDA DE GOIANIA	15011446	REAL S1	08/12/2020 16:03	09/12/2020 07:19	08/12/2020 16:03	09/12/2020 07:19	15,26	1	15,26	CHI
20201240827	QUIRINOPOLIS	QI21227778	QUIRINOPOLIS	08/12/2020 16:03	08/12/2020 23:37	08/12/2020 16:03	08/12/2020 23:37	7,56	1	7,56	CHI
20201240830	FORMOSA	FA11085451	ITUIQUIRA	08/12/2020 16:03	08/12/2020 19:02	08/12/2020 16:03	08/12/2020 19:02	2,97	3	8,91	CHI
20201240834	SANTA HELENA DE GOIAS	400092074	IPEGUARI	08/12/2020 16:04	09/12/2020 13:57	08/12/2020 16:04	09/12/2020 13:57	21,88	1	21,88	CHI
20201241099	RIO VERDE	RV12123331	RIO VERDE S1	08/12/2020 16:04	08/12/2020 23:24	08/12/2020 16:04	08/12/2020 23:24	7,33	47	344,56	CHI
20201241574	VILA PROPICIO	NP12382314	GOIANESIA S1	08/12/2020 16:04	09/12/2020 22:54	08/12/2020 16:04	09/12/2020 22:54	30,84	8	246,76	CHI
20201241574	VILA PROPICIO	NP12382314	GOIANESIA S1	08/12/2020 16:04	09/12/2020 22:54	09/12/2020 20:34	09/12/2020 22:54	2,33	4	9,32	CHI
20201241812	PETROLINA DE GOIAS	PG12401921	PETROLINA	08/12/2020 16:04	10/12/2020 15:57	08/12/2020 16:04	10/12/2020 07:24	39,35	20	786,94	CHI
20201241812	PETROLINA DE GOIAS	PG12401921	PETROLINA	08/12/2020 16:04	10/12/2020 15:57	08/12/2020 16:04	10/12/2020 15:57	47,89	5	239,47	CHI
20201240853	GOIANIA	GN11000275	AEROPORTO S3	08/12/2020 16:05	08/12/2020 21:02	08/12/2020 16:05	08/12/2020 21:02	4,94	62	306,59	CHI
20201240951	MONTES CLAROS DE GOIAS	ME12140008	IPORA	08/12/2020 16:05	09/12/2020 02:24	08/12/2020 16:05	09/12/2020 02:24	10,31	18	185,61	CHI
20201240858	PLANALTINA	PI21128912	SAO JOAO D ALIANCA	08/12/2020 16:06	10/12/2020 08:37	08/12/2020 16:06	10/12/2020 08:37	40,52	1	40,52	CHI
20201240916	ITUMBIARA	IT11000081	ITUMBIARA VELHA S1	08/12/2020 16:06	08/12/2020 19:37	08/12/2020 16:06	08/12/2020 19:37	3,51	173	606,70	CHI
20201240871	BURITI ALEGRE	BG12066322	ALTO BURITI	08/12/2020 16:07	09/12/2020 11:49	08/12/2020 16:07	09/12/2020 11:49	19,71	17	335,00	CHI
20201240875	CACU	CC21021387	CACHOEIRA ALTA	08/12/2020 16:07	08/12/2020 19:56	08/12/2020 16:07	08/12/2020 19:56	3,82	1	3,82	CHI
20201240883	AMORINOPOLIS	AM12000024	IPORA	08/12/2020 16:07	08/12/2020 21:06	08/12/2020 16:07	08/12/2020 21:06	4,97	1	4,97	CHI
20201240884	MORRINHOS	MR12333296	GOIATUBA S1	08/12/2020 16:07	08/12/2020 22:50	08/12/2020 16:07	08/12/2020 22:50	6,70	2	13,40	CHI
20201240885	CAMPO ALEGRE DE GOIAS	CM21235322	CAMPO ALEGRE DE GOIAS	08/12/2020 16:07	08/12/2020 18:15	08/12/2020 16:07	08/12/2020 18:15	2,12	1	2,12	CHI
20201240903	APARECIDA DE GOIANIA	AP12241426	REAL S1	08/12/2020 16:07	08/12/2020 17:46	08/12/2020 16:07	08/12/2020 17:46	1,65	810	1334,02	CHI

20201241050	GOIANIA	GN11329359	ATLANTICO S2	08/12/2020 16:07	08/12/2020 18:48	08/12/2020 16:07	08/12/2020 18:48	2,67	66	176,05	CHI
20201241379	CATURAI	CK12018558	INHUMAS S1	08/12/2020 16:07	09/12/2020 11:35	08/12/2020 16:07	09/12/2020 09:35	17,46	16	279,32	CHI
20201241379	CATURAI	CK12018876	INHUMAS S1	08/12/2020 16:07	09/12/2020 11:35	09/12/2020 10:05	09/12/2020 11:30	1,41	6	8,45	CHI
20201241379	CATURAI	CK12066124LD	INHUMAS S1	08/12/2020 16:07	09/12/2020 11:35	09/12/2020 10:05	09/12/2020 11:35	1,49	8	11,93	CHI
20201243154	INHUMAS	IN11012240	INHUMAS S2	08/12/2020 16:07	08/12/2020 19:56	08/12/2020 16:07	08/12/2020 19:56	3,80	42	159,75	CHI
20201240891	JATAI	290245540	JATAI S2	08/12/2020 16:08	09/12/2020 10:14	08/12/2020 16:08	09/12/2020 10:14	18,09	1	18,09	CHI
20201240895	NOVO GAMA	10006084620	MARAJOARA	08/12/2020 16:08	09/12/2020 00:17	08/12/2020 16:08	09/12/2020 00:17	8,14	1	8,14	CHI
20201241094	SANTA CRUZ DE GOIAS	PZ12073341RE	PIRES DO RIO S2	08/12/2020 16:08	09/12/2020 17:45	08/12/2020 16:08	09/12/2020 12:04	19,94	36	717,80	CHI
20201241094	PIRES DO RIO	PZ12073341RE	PIRES DO RIO S2	08/12/2020 16:08	09/12/2020 17:45	08/12/2020 16:08	09/12/2020 12:54	20,77	6	124,63	CHI
20201241094	PALMELO	PZ12073341RE	PIRES DO RIO S2	08/12/2020 16:08	09/12/2020 17:45	08/12/2020 16:08	09/12/2020 12:54	20,77	24	498,52	CHI
20201241094	SANTA CRUZ DE GOIAS	PZ12073341RE	PIRES DO RIO S2	08/12/2020 16:08	09/12/2020 17:45	08/12/2020 16:08	09/12/2020 12:54	20,77	28	581,61	CHI
20201241094	SANTA CRUZ DE GOIAS	PZ12073341RE	PIRES DO RIO S2	08/12/2020 16:08	09/12/2020 17:45	08/12/2020 16:08	09/12/2020 17:45	25,61	1	25,61	CHI
20201240910	FORMOSA	610080714	ITUIQUIRA	08/12/2020 16:09	08/12/2020 23:01	08/12/2020 16:09	08/12/2020 23:01	6,86	1	6,86	CHI
20201241023	PADRE BERNARDO	01370214	PADRE BERNARDO	08/12/2020 16:09	09/12/2020 19:30	08/12/2020 16:11	08/12/2020 16:15	0,07	2737	189,31	CHI
20201241023	PADRE BERNARDO	01370214	PADRE BERNARDO	08/12/2020 16:09	09/12/2020 19:30	08/12/2020 16:11	08/12/2020 17:13	1,03	496	512,95	CHI
20201241023	PADRE BERNARDO	01370214	PADRE BERNARDO	08/12/2020 16:09	09/12/2020 19:30	08/12/2020 16:11	08/12/2020 17:14	1,06	93	98,45	CHI
20201241023	PADRE BERNARDO	01370214	PADRE BERNARDO	08/12/2020 16:09	09/12/2020 19:30	08/12/2020 16:11	08/12/2020 17:37	1,43	1119	1604,21	CHI
20201241023	PADRE BERNARDO	01370214	PADRE BERNARDO	08/12/2020 16:09	09/12/2020 19:30	08/12/2020 18:31	08/12/2020 18:46	0,25	4445	1090,26	CHI
20201241023	PLANALTINA	01370214	PADRE BERNARDO	08/12/2020 16:09	09/12/2020 19:30	08/12/2020 16:11	08/12/2020 19:42	3,52	11	38,73	CHI
20201241023	PADRE BERNARDO	01370214	PADRE BERNARDO	08/12/2020 16:09	09/12/2020 19:30	08/12/2020 16:11	08/12/2020 19:42	3,52	111	390,81	CHI
20201241023	PADRE BERNARDO	01370214	PADRE BERNARDO	08/12/2020 16:09	09/12/2020 19:30	08/12/2020 16:11	08/12/2020 21:54	5,73	3	17,18	CHI
20201241023	AGUA FRIA DE GOIAS	01370214	PADRE BERNARDO	08/12/2020 16:09	09/12/2020 19:30	08/12/2020 16:11	09/12/2020 03:40	11,48	10	114,81	CHI
20201241023	NIQUELANDIA	01370214	PADRE BERNARDO	08/12/2020 16:09	09/12/2020 19:30	08/12/2020 16:11	09/12/2020 03:40	11,48	1	11,48	CHI
20201241023	MIMOSO DE GOIAS	01370214	PADRE BERNARDO	08/12/2020 16:09	09/12/2020 19:30	08/12/2020 16:11	09/12/2020 03:40	11,48	1068	12261,23	CHI
20201241023	MIMOSO DE GOIAS	01370214	PADRE BERNARDO	08/12/2020 16:09	09/12/2020 19:30	08/12/2020 16:11	09/12/2020 03:40	11,48	1	11,48	CHI
20201241023	AGUA FRIA DE GOIAS	01370214	PADRE BERNARDO	08/12/2020 16:09	09/12/2020 19:30	08/12/2020 16:11	09/12/2020 03:40	11,48	1	11,48	CHI
20201241023	PADRE BERNARDO	01370214	PADRE BERNARDO	08/12/2020 16:09	09/12/2020 19:30	09/12/2020 03:41	09/12/2020 03:53	0,20	4559	908,00	CHI
20201241023	PLANALTINA	01370214	PADRE BERNARDO	08/12/2020 16:09	09/12/2020 19:30	09/12/2020 03:41	09/12/2020 03:53	0,20	11	2,19	CHI
20201241023	MIMOSO DE GOIAS	PB13413185	PADRE BERNARDO	08/12/2020 16:09	09/12/2020 19:30	09/12/2020 03:41	09/12/2020 03:56	0,24	1	0,24	CHI
20201241023	MIMOSO DE GOIAS	PB13413185	PADRE BERNARDO	08/12/2020 16:09	09/12/2020 19:30	09/12/2020 03:41	09/12/2020 14:59	11,29	1068	12058,02	CHI
20201241023	NIQUELANDIA	PB13413185	PADRE BERNARDO	08/12/2020 16:09	09/12/2020 19:30	09/12/2020 03:41	09/12/2020 14:59	11,29	1	11,29	CHI
20201241023	AGUA FRIA DE GOIAS	PB13413185	PADRE BERNARDO	08/12/2020 16:09	09/12/2020 19:30	09/12/2020 03:41	09/12/2020 14:59	11,29	11	124,19	CHI
20201241023	MIMOSO DE GOIAS	PB13413185	PADRE BERNARDO	08/12/2020 16:09	09/12/2020 19:30	09/12/2020 03:57	09/12/2020 14:59	11,03	1	11,03	CHI
20201241023	PADRE BERNARDO	01370214	PADRE BERNARDO	08/12/2020 16:09	09/12/2020 19:30	08/12/2020 16:11	09/12/2020 19:24	27,22	2	54,44	CHI
20201241023	PADRE BERNARDO	01370214	PADRE BERNARDO	08/12/2020 16:09	09/12/2020 19:30	08/12/2020 16:11	09/12/2020 19:30	27,33	1	27,33	CHI
20201241586	MONTES CLAROS DE GOIAS	ME12050933	IPORA	08/12/2020 16:11	09/12/2020 16:38	08/12/2020 16:11	09/12/2020 16:38	24,44	7	171,11	CHI
20201241860	MINEIROS	MY12197099	PARQUE DAS EMAS	08/12/2020 16:12	09/12/2020 11:07	08/12/2020 16:12	09/12/2020 11:07	18,90	9	170,14	CHI
20201240957	PIRANHAS	PH12390164	PIRANHAS	08/12/2020 16:13	08/12/2020 18:10	08/12/2020 16:13	08/12/2020 18:10	1,95	4	7,80	CHI
20201240960	INDIARA	IY121066107	EDEIA	08/12/2020 16:13	08/12/2020 21:04	08/12/2020 16:13	08/12/2020 21:04	4,84	1	4,84	CHI
20201240964	MINEIROS	MY12325793	PARQUE DAS EMAS	08/12/2020 16:13	08/12/2020 17:52	08/12/2020 16:13	08/12/2020 17:52	1,64	3	4,92	CHI
20201241063	GOIANIA	GN16434736	MEIA PONTE	08/12/2020 16:13	08/12/2020 19:03	08/12/2020 16:13	08/12/2020 19:03	2,83	1102	3122,64	CHI
20201241183	PARANAIGUARA	PC12070705	QUIRINOPOLIS	08/12/2020 16:13	08/12/2020 19:34	08/12/2020 16:13	08/12/2020 19:34	3,34	36	120,22	CHI
20201240995	MONTIVIDIU	MV12260796	MONTIVIDIU T	08/12/2020 16:15	08/12/2020 19:53	08/12/2020 16:15	08/12/2020 19:53	3,63	2	7,26	CHI
20201240995	RIO VERDE	MV12260796	MONTIVIDIU T	08/12/2020 16:15	08/12/2020 19:53	08/12/2020 16:15	08/12/2020 19:53	3,63	2	7,26	CHI
20201243639	JESUPOLIS	SF12000163	SAO FRANCISCO DE GOIAS	08/12/2020 16:15	10/12/2020 00:28	08/12/2020 16:15	10/12/2020 00:28	32,21	25	805,26	CHI
20201241012	ANAPOLIS	20751783	JUNDIAI S2	08/12/2020 16:16	08/12/2020 22:53	08/12/2020 16:16	08/12/2020 22:53	6,60	1	6,60	CHI
20201241013	GOIANIA	15609534	GOYA S2	08/12/2020 16:16	09/12/2020 09:54	08/12/2020 16:16	09/12/2020 09:54	17,62	1	17,62	CHI
20201241092	ORIZONA	OZ13048766	PIRES DO RIO S2	08/12/2020 16:16	10/12/2020 20:23	08/12/2020 16:16	08/12/2020 20:08	3,85	377	1453,13	CHI
20201241092	ORIZONA	OZ10359309	PIRES DO RIO S2	08/12/2020 16:16	10/12/2020 20:23	08/12/2020 16:16	08/12/2020 20:08	3,85	20	77,09	CHI
20201241092	LUZIANIA	OZ13048766	PIRES DO RIO S2	08/12/2020 16:16	10/12/2020 20:23	08/12/2020 16:16	08/12/2020 20:08	3,85	2	7,71	CHI
20201241092	ORIZONA	OZ10359309	PIRES DO RIO S2	08/12/2020 16:16	10/12/2020 20:23	08/12/2020 16:16	08/12/2020 21:12	4,93	40	197,33	CHI

20201241092	ORIZONA	OZ10359309	PIRES DO RIO S2	08/12/2020 16:16	10/12/2020 20:23	08/12/2020 22:41	08/12/2020 23:10	0,48	40	19,16	CHI
20201241092	ORIZONA	OZ10359309	PIRES DO RIO S2	08/12/2020 16:16	10/12/2020 20:23	08/12/2020 23:32	08/12/2020 23:42	0,17	40	6,64	CHI
20201241092	ORIZONA	OZ10359309	PIRES DO RIO S2	08/12/2020 16:16	10/12/2020 20:23	09/12/2020 02:02	09/12/2020 02:21	0,32	40	12,62	CHI
20201241092	ORIZONA	OZ10359309	PIRES DO RIO S2	08/12/2020 16:16	10/12/2020 20:23	08/12/2020 16:16	09/12/2020 04:43	12,44	3	37,31	CHI
20201241092	ORIZONA	OZ12022866	PIRES DO RIO S2	08/12/2020 16:16	10/12/2020 20:23	08/12/2020 16:16	09/12/2020 08:27	16,18	23	372,03	CHI
20201241092	ORIZONA	OZ12090288	PIRES DO RIO S2	08/12/2020 16:16	10/12/2020 20:23	08/12/2020 16:16	09/12/2020 08:59	16,71	10	167,15	CHI
20201241092	ORIZONA	OZ10359309	PIRES DO RIO S2	08/12/2020 16:16	10/12/2020 20:23	08/12/2020 16:16	09/12/2020 17:11	24,92	9	224,24	CHI
20201241092	ORIZONA	OZ12311657	PIRES DO RIO S2	08/12/2020 16:16	10/12/2020 20:23	08/12/2020 16:16	09/12/2020 19:50	27,56	4	110,23	CHI
20201241092	ORIZONA	OZ10359309	PIRES DO RIO S2	08/12/2020 16:16	10/12/2020 20:23	08/12/2020 16:16	10/12/2020 00:34	32,30	4	129,20	CHI
20201241092	ORIZONA	OZ10359309	PIRES DO RIO S2	08/12/2020 16:16	10/12/2020 20:23	09/12/2020 23:48	10/12/2020 00:34	0,78	89	69,25	CHI
20201241092	ORIZONA	OZ10300885	PIRES DO RIO S2	08/12/2020 16:16	10/12/2020 20:23	08/12/2020 16:16	10/12/2020 07:47	39,50	138	5451,54	CHI
20201241092	ORIZONA	OZ10300885	PIRES DO RIO S2	08/12/2020 16:16	10/12/2020 20:23	10/12/2020 08:57	10/12/2020 09:07	0,16	138	21,58	CHI
20201241092	ORIZONA	OZ13266325	PIRES DO RIO S2	08/12/2020 16:16	10/12/2020 20:23	10/12/2020 13:43	10/12/2020 13:52	0,16	20	3,22	CHI
20201241092	ORIZONA	OZ10300885	PIRES DO RIO S2	08/12/2020 16:16	10/12/2020 20:23	08/12/2020 16:16	10/12/2020 19:43	51,44	7	360,11	CHI
20201241092	ORIZONA	OZ10300885	PIRES DO RIO S2	08/12/2020 16:16	10/12/2020 20:23	08/12/2020 16:16	10/12/2020 19:43	51,45	74	3807,46	CHI
20201241092	ORIZONA	OZ12022982LD	PIRES DO RIO S2	08/12/2020 16:16	10/12/2020 20:23	08/12/2020 16:16	10/12/2020 19:58	51,69	239	12354,57	CHI
20201241092	ORIZONA	OZ12022888	PIRES DO RIO S2	08/12/2020 16:16	10/12/2020 20:23	08/12/2020 16:16	10/12/2020 20:23	52,11	38	1980,25	CHI
20201241092	ORIZONA	OZ12114508	PIRES DO RIO S2	08/12/2020 16:16	10/12/2020 20:23	08/12/2020 16:16	10/12/2020 20:23	52,12	11	573,27	CHI
20201241336	FORMOSA	FA12322759	ITIQUEIRA	08/12/2020 16:16	08/12/2020 23:30	08/12/2020 16:16	08/12/2020 23:30	7,23	20	144,68	CHI
20201241336	DISTRITO FEDERAL	FA12322759	ITIQUEIRA	08/12/2020 16:16	08/12/2020 23:30	08/12/2020 16:16	08/12/2020 23:30	7,23	1	7,23	CHI
20201241028	ARUANA	AK21187700	MOZARLANDIA	08/12/2020 16:17	08/12/2020 20:13	08/12/2020 16:17	08/12/2020 20:13	3,92	1	3,92	CHI
20201241035	INDIARA	IY12057315	EDEIA	08/12/2020 16:18	08/12/2020 18:23	08/12/2020 16:18	08/12/2020 18:23	2,07	5	10,37	CHI
20201241074	ORIZONA	VN10406899	VIANOPOLIS	08/12/2020 16:18	09/12/2020 12:17	08/12/2020 16:18	09/12/2020 12:17	19,99	38	759,48	CHI
20201241074	VIANOPOLIS	VN10406899	VIANOPOLIS	08/12/2020 16:18	09/12/2020 12:17	08/12/2020 16:18	09/12/2020 12:17	19,99	155	3097,89	CHI
20201241074	MORRINHOS	VN13200161	VIANOPOLIS	08/12/2020 16:18	09/12/2020 12:17	08/12/2020 16:38	09/12/2020 12:17	19,65	1	19,65	CHI
20201241074	VIANOPOLIS	VN13200161	VIANOPOLIS	08/12/2020 16:18	09/12/2020 12:17	08/12/2020 16:38	09/12/2020 12:17	19,65	515	10119,32	CHI
20201241074	SILVANIA	VN13200161	VIANOPOLIS	08/12/2020 16:18	09/12/2020 12:17	08/12/2020 16:38	09/12/2020 12:17	19,65	7	137,54	CHI
20201241074	ORIZONA	VN13200161	VIANOPOLIS	08/12/2020 16:18	09/12/2020 12:17	08/12/2020 16:38	09/12/2020 12:17	19,65	58	1139,65	CHI
20201241074	VIANOPOLIS	VN13200161	VIANOPOLIS	08/12/2020 16:18	09/12/2020 12:17	08/12/2020 19:40	09/12/2020 12:17	16,63	5	83,13	CHI
20201243546	PIRANHAS	PH12092232	BOM JARDIM	08/12/2020 16:18	08/12/2020 22:16	08/12/2020 16:18	08/12/2020 22:16	5,95	8	47,63	CHI
20201241051	JARAGUA	GE12354152	GOIANESIA S2	08/12/2020 16:20	08/12/2020 20:15	08/12/2020 16:20	08/12/2020 20:15	3,91	1	3,91	CHI
20201241051	GOIANESIA	GE12354152	GOIANESIA S2	08/12/2020 16:20	08/12/2020 20:15	08/12/2020 16:20	08/12/2020 20:15	3,91	1	3,91	CHI
20201241054	GUARINOS	GF21164887	SANTA TEREZINHA	08/12/2020 16:20	09/12/2020 08:45	08/12/2020 16:20	09/12/2020 08:45	16,41	1	16,41	CHI
20201241061	INHUMAS	30097605	INHUMAS S2	08/12/2020 16:21	08/12/2020 20:59	08/12/2020 16:21	08/12/2020 20:59	4,63	1	4,63	CHI
20201241065	RIO VERDE	RV21073781	QUIRINOPOLIS	08/12/2020 16:21	09/12/2020 13:00	08/12/2020 16:21	09/12/2020 13:00	20,64	1	20,64	CHI
20201241384	APARECIDA DE GOIANIA	AP11167503	ATLANTICO S2	08/12/2020 16:21	08/12/2020 20:03	08/12/2020 16:21	08/12/2020 20:03	3,69	96	354,45	CHI
20201241850	JANDAIA	JD12008602	PALMEIRAS	08/12/2020 16:21	09/12/2020 16:44	08/12/2020 16:21	09/12/2020 16:44	24,38	9	219,46	CHI
20201241081	GOIATUBA	GT12247742	BOM JESUS DE GOIAS	08/12/2020 16:22	08/12/2020 18:33	08/12/2020 16:22	08/12/2020 18:33	2,17	7	15,18	CHI
20201242931	ITAPIRAPUA	IU13071472	JUSSARA	08/12/2020 16:22	10/12/2020 03:58	09/12/2020 21:13	09/12/2020 21:30	0,29	31	8,92	CHI
20201242931	ITAPIRAPUA	IU12037339	JUSSARA	08/12/2020 16:22	10/12/2020 03:58	08/12/2020 16:22	10/12/2020 03:58	35,60	7	249,22	CHI
20201242931	NOVO BRASIL	IU12037339	JUSSARA	08/12/2020 16:22	10/12/2020 03:58	08/12/2020 16:22	10/12/2020 03:58	35,60	1	35,60	CHI
20201241088	CRIXAS	2490032799	SERRA DO OURO	08/12/2020 16:23	08/12/2020 20:43	08/12/2020 16:23	08/12/2020 20:43	4,32	1	4,32	CHI
20201243064	GOIANIA	GN12057362	CARAJAS S1	08/12/2020 16:23	09/12/2020 07:55	08/12/2020 16:23	09/12/2020 07:55	15,54	194	3013,79	CHI
20201243075	PEROLANDIA	DP12260360	JATAI S1	08/12/2020 16:23	09/12/2020 00:15	08/12/2020 16:23	09/12/2020 00:15	7,86	3	23,59	CHI
20201241100	GUARINOS	GF12185477	SANTA TEREZINHA	08/12/2020 16:24	09/12/2020 17:21	08/12/2020 16:24	08/12/2020 20:52	4,46	1	4,46	CHI
20201241100	GUARINOS	GF12185477	SANTA TEREZINHA	08/12/2020 16:24	09/12/2020 17:21	09/12/2020 08:32	09/12/2020 10:12	1,68	1	1,68	CHI
20201241100	GUARINOS	GF12185477	SANTA TEREZINHA	08/12/2020 16:24	09/12/2020 17:21	08/12/2020 16:24	09/12/2020 17:21	24,94	5	124,70	CHI
20201241102	GOIANIA	10011063953	MEIA PONTE	08/12/2020 16:25	08/12/2020 21:34	08/12/2020 16:25	08/12/2020 21:34	5,15	1	5,15	CHI
20201241106	GOIANIRA	GR11287759	MEIA PONTE	08/12/2020 16:25	08/12/2020 21:17	08/12/2020 16:25	08/12/2020 21:17	4,86	161	782,50	CHI
20201241110	VIANOPOLIS	VN21062752	VIANOPOLIS	08/12/2020 16:25	08/12/2020 20:00	08/12/2020 16:25	08/12/2020 20:00	3,57	1	3,57	CHI
20201245123	RIO VERDE	QI12370150	QUIRINOPOLIS	08/12/2020 16:25	09/12/2020 11:00	08/12/2020 16:25	09/12/2020 11:00	18,58	1	18,58	CHI

20201245123	QUIRINOPOLIS	Q12370150	QUIRINOPOLIS	08/12/2020 16:25	09/12/2020 11:00	08/12/2020 16:25	09/12/2020 11:00	18,58	11	204,39	CHI
20201245123	CASTELANDIA	Q12370150	QUIRINOPOLIS	08/12/2020 16:25	09/12/2020 11:00	08/12/2020 16:25	09/12/2020 11:00	18,58	17	315,87	CHI
20201241133	PIRES DO RIO	PR12166937	PIRES DO RIO S1	08/12/2020 16:26	08/12/2020 17:27	08/12/2020 16:26	08/12/2020 17:27	1,01	115	115,93	CHI
20201241125	SANTA RITA DO ARAGUAIA	10004874089	SANTA RITA DO ARAGUAIA	08/12/2020 16:27	08/12/2020 22:00	08/12/2020 16:27	08/12/2020 22:00	5,54	1	5,54	CHI
20201241127	ALVORADA DO NORTE	AQ11060067	IACIARA S2	08/12/2020 16:27	09/12/2020 00:42	08/12/2020 16:27	09/12/2020 00:42	8,24	127	1046,23	CHI
20201241171	CALDAS NOVAS	CN12182800LD	SERRA DE CALDAS	08/12/2020 16:27	09/12/2020 14:43	08/12/2020 16:27	09/12/2020 14:43	22,26	10	222,63	CHI
20201241895	NIQUELANDIA	NQ12262781	URUACU	08/12/2020 16:27	08/12/2020 18:43	08/12/2020 16:27	08/12/2020 18:43	2,26	8	18,11	CHI
20201241148	CACHOEIRA ALTA	CA12194883	CACHOEIRA ALTA	08/12/2020 16:29	08/12/2020 20:05	08/12/2020 16:29	08/12/2020 20:05	3,59	66	236,63	CHI
20201241148	PARANAIGUARA	CA12194883	CACHOEIRA ALTA	08/12/2020 16:29	08/12/2020 20:05	08/12/2020 16:29	08/12/2020 20:05	3,59	34	121,90	CHI
20201241265	GOIANIA	GN11335555	CAMPINAS S2	08/12/2020 16:29	08/12/2020 18:35	08/12/2020 16:29	08/12/2020 18:35	2,10	116	243,57	CHI
20201241160	CAMPINORTE	MQ21138030	MARA ROSA	08/12/2020 16:30	08/12/2020 19:50	08/12/2020 16:30	08/12/2020 19:50	3,32	1	3,32	CHI
20201241235	MONTIVIDIU	MV12054362	MONTIVIDIU T	08/12/2020 16:30	08/12/2020 20:51	08/12/2020 16:30	08/12/2020 20:51	4,34	4	17,34	CHI
20201241162	AGUA FRIA DE GOIAS	TL12208770	SAO JOAO D ALIANCA	08/12/2020 16:31	08/12/2020 22:06	08/12/2020 16:31	08/12/2020 22:06	5,58	58	323,82	CHI
20201241203	LUZIANIA	LZ13168077	VIANOPOLIS	08/12/2020 16:31	09/12/2020 14:20	08/12/2020 16:31	08/12/2020 22:12	5,68	222	1261,70	CHI
20201241203	ORIZONA	LZ13168077	VIANOPOLIS	08/12/2020 16:31	09/12/2020 14:20	08/12/2020 16:31	08/12/2020 22:12	5,68	159	903,65	CHI
20201241203	SILVANIA	LZ13168077	VIANOPOLIS	08/12/2020 16:31	09/12/2020 14:20	08/12/2020 16:31	08/12/2020 22:12	5,68	116	659,27	CHI
20201241203	LUZIANIA	LZ13171667	VIANOPOLIS	08/12/2020 16:31	09/12/2020 14:20	08/12/2020 16:31	09/12/2020 14:20	21,83	91	1986,10	CHI
20201244478	URUTAI	UT12016932RE	URUTAI	08/12/2020 16:31	09/12/2020 01:42	08/12/2020 16:31	09/12/2020 01:42	9,18	5	45,88	CHI
20201244478	IPAMERI	UT12016932RE	URUTAI	08/12/2020 16:31	09/12/2020 01:42	08/12/2020 16:31	09/12/2020 01:42	9,18	3	27,53	CHI
20201244593	APARECIDA DE GOIANIA	AP11141263	CEPAIGO S1	08/12/2020 16:31	09/12/2020 00:58	08/12/2020 16:31	09/12/2020 00:58	8,43	61	514,48	CHI
20201241178	GUARINOS	GF21314341	SANTA TEREZINHA	08/12/2020 16:32	09/12/2020 02:48	08/12/2020 16:32	09/12/2020 02:48	10,26	1	10,26	CHI
20201241181	PIRES DO RIO	PR12409073	PIRES DO RIO S2	08/12/2020 16:32	08/12/2020 18:54	08/12/2020 16:32	08/12/2020 18:54	2,36	8	18,84	CHI
202012124624	JATAI	JT13214392	JATAI S1	08/12/2020 16:32	08/12/2020 20:24	08/12/2020 16:32	08/12/2020 20:24	3,87	518	2002,36	CHI
202012124624	SERRANOPOLIS	JT13214392	JATAI S1	08/12/2020 16:32	08/12/2020 20:24	08/12/2020 16:32	08/12/2020 20:24	3,87	66	255,13	CHI
20201241182	SAO DOMINGOS	SD21255093	SAO DOMINGOS	08/12/2020 16:33	08/12/2020 18:15	08/12/2020 16:33	08/12/2020 18:15	1,70	2	3,40	CHI
20201241191	CORUMBAIBA	CI12263342LD	VILA CORUMBA	08/12/2020 16:33	09/12/2020 07:20	08/12/2020 16:33	09/12/2020 07:20	14,78	415	6134,28	CHI
20201241276	ALEXANIA	AX11000006	ALEXANIA	08/12/2020 16:33	08/12/2020 19:05	08/12/2020 16:33	08/12/2020 19:05	2,52	75	189,15	CHI
20201243036	GOIANIA	GN11255210	GOYA S1	08/12/2020 16:33	08/12/2020 23:36	08/12/2020 16:33	08/12/2020 23:36	7,04	85	598,47	CHI
20201241380	ANAPOLIS	AN11107980	ANAPOLIS UNIVERSITARIO S2	08/12/2020 16:34	09/12/2020 00:13	08/12/2020 16:34	09/12/2020 00:13	7,65	127	971,59	CHI
20201241666	JATAI	JT12226486	JATAI S1	08/12/2020 16:34	09/12/2020 01:16	08/12/2020 16:34	09/12/2020 01:16	8,70	28	243,51	CHI
20201241215	PARAUNA	980052543	PARAUNA	08/12/2020 16:36	08/12/2020 18:49	08/12/2020 16:36	08/12/2020 18:49	2,21	1	2,21	CHI
20201241217	ABADIANIA	AA12376522	ANAPOLIS UNIVERSITARIO S1	08/12/2020 16:36	08/12/2020 19:28	08/12/2020 16:36	08/12/2020 19:28	2,86	62	177,42	CHI
20201241414	GAMELEIRA DE GOIAS	AN12285354	ANAPOLIS UNIVERSITARIO S2	08/12/2020 16:36	08/12/2020 19:13	08/12/2020 16:36	08/12/2020 19:13	2,60	8	20,82	CHI
20201241414	SILVANIA	AN12285354	ANAPOLIS UNIVERSITARIO S2	08/12/2020 16:36	08/12/2020 19:13	08/12/2020 16:36	08/12/2020 19:13	2,60	20	52,06	CHI
20201243338	CABECEIRAS	CW12181804	ITUIQUIRA	08/12/2020 16:36	09/12/2020 08:59	08/12/2020 16:36	09/12/2020 08:59	16,38	8	131,02	CHI
20201241239	SAO JOAO D ALIANCA	JL12117452	SAO JOAO D ALIANCA	08/12/2020 16:38	09/12/2020 17:48	08/12/2020 16:38	09/12/2020 17:48	25,17	5	125,87	CHI
20201241244	FORMOSA	FA31051028	SAO JOAO D ALIANCA	08/12/2020 16:38	08/12/2020 21:43	08/12/2020 16:38	08/12/2020 21:43	5,07	1	5,07	CHI
20201241247	INDIARA	2710003576	EDEIA	08/12/2020 16:39	08/12/2020 22:12	08/12/2020 16:39	08/12/2020 22:12	5,55	1	5,55	CHI
20201241254	APARECIDA DE GOIANIA	200391940	INDEPENDENCIA S2	08/12/2020 16:39	08/12/2020 17:32	08/12/2020 16:39	08/12/2020 17:32	0,87	1	0,87	CHI
20201241325	IPAMERI	CM10415031	CAMPO ALEGRE DE GOIAS	08/12/2020 16:39	09/12/2020 19:32	08/12/2020 16:45	08/12/2020 19:52	3,13	3	9,38	CHI
20201241325	IPAMERI	CM10415031	PIRES DO RIO S2	08/12/2020 16:39	09/12/2020 19:32	08/12/2020 16:39	08/12/2020 20:52	4,23	8	33,84	CHI
20201241325	IPAMERI	IP13252413	PIRES DO RIO S2	08/12/2020 16:39	09/12/2020 19:32	08/12/2020 16:45	08/12/2020 20:52	4,13	9	37,14	CHI
20201241325	CAMPO ALEGRE DE GOIAS	CM10415031	CAMPO ALEGRE DE GOIAS	08/12/2020 16:39	09/12/2020 19:32	08/12/2020 20:52	08/12/2020 21:17	0,41	84	34,58	CHI
20201241325	IPAMERI	CM10415031	CAMPO ALEGRE DE GOIAS	08/12/2020 16:39	09/12/2020 19:32	08/12/2020 20:52	08/12/2020 21:17	0,41	81	33,35	CHI
20201241325	IPAMERI	CM10415031	PIRES DO RIO S2	08/12/2020 16:39	09/12/2020 19:32	08/12/2020 16:39	08/12/2020 23:34	6,92	95	657,27	CHI
20201241325	IPAMERI	IP13252413	PIRES DO RIO S2	08/12/2020 16:39	09/12/2020 19:32	08/12/2020 16:45	08/12/2020 23:34	6,82	1	6,82	CHI
20201241325	CAMPO ALEGRE DE GOIAS	CM10415031	PIRES DO RIO S2	08/12/2020 16:39	09/12/2020 19:32	08/12/2020 16:39	09/12/2020 00:14	7,59	18	136,64	CHI
20201241325	IPAMERI	CM10415031	PIRES DO RIO S2	08/12/2020 16:39	09/12/2020 19:32	08/12/2020 16:39	09/12/2020 00:14	7,59	41	311,25	CHI
20201241325	CAMPO ALEGRE DE GOIAS	IP13186519	PIRES DO RIO S2	08/12/2020 16:39	09/12/2020 19:32	08/12/2020 16:45	09/12/2020 00:14	7,49	1	7,49	CHI
20201241325	PIRES DO RIO	01480414	PIRES DO RIO S2	08/12/2020 16:39	09/12/2020 19:32	09/12/2020 10:43	09/12/2020 11:08	0,41	10	4,15	CHI
20201241325	URUTAI	01480414	PIRES DO RIO S2	08/12/2020 16:39	09/12/2020 19:32	09/12/2020 10:43	09/12/2020 11:08	0,41	65	26,96	CHI

20201241325	ORIZONA	01480414	PIRES DO RIO S2	08/12/2020 16:39	09/12/2020 19:32	09/12/2020 10:43	09/12/2020 11:08	0,41	2	0,83	CHI
20201241325	ORIZONA	CM10415031	PIRES DO RIO S2	08/12/2020 16:39	09/12/2020 19:32	08/12/2020 16:39	09/12/2020 17:40	25,02	6	150,09	CHI
20201241325	URUTAI	CM10415031	PIRES DO RIO S2	08/12/2020 16:39	09/12/2020 19:32	08/12/2020 16:39	09/12/2020 17:40	25,02	31	775,49	CHI
20201241325	URUTAI	IP13252413	PIRES DO RIO S2	08/12/2020 16:39	09/12/2020 19:32	08/12/2020 16:45	09/12/2020 17:40	24,91	1	24,91	CHI
20201241325	ORIZONA	CM10415031	PIRES DO RIO S2	08/12/2020 16:39	09/12/2020 19:32	08/12/2020 16:39	09/12/2020 19:32	26,89	1	26,89	CHI
20201241325	IPAMERI	CM10415031	PIRES DO RIO S2	08/12/2020 16:39	09/12/2020 19:32	08/12/2020 16:39	09/12/2020 19:32	26,89	114	3064,89	CHI
20201241325	URUTAI	CM10415031	PIRES DO RIO S2	08/12/2020 16:39	09/12/2020 19:32	08/12/2020 16:39	09/12/2020 19:32	26,89	6	161,31	CHI
20201241594	SILVANIA	SV12058432	DAIA S2	08/12/2020 16:39	08/12/2020 19:30	08/12/2020 16:39	08/12/2020 19:30	2,84	10	28,38	CHI
20201244306	EDEIA	EA11171717	EDEIA	08/12/2020 16:39	08/12/2020 22:29	08/12/2020 16:39	08/12/2020 22:29	5,82	36	209,60	CHI
20201241259	GOIANIA	10032518755	GOIANIA LESTE S3	08/12/2020 16:40	08/12/2020 22:04	08/12/2020 16:40	08/12/2020 22:04	5,40	1	5,40	CHI
20201241271	CALDAS NOVAS	760195493	SERRA DE CALDAS	08/12/2020 16:41	08/12/2020 18:06	08/12/2020 16:41	08/12/2020 18:06	1,42	1	1,42	CHI
20201241281	RIO QUENTE	RQ12316156	VILA CORUMBA	08/12/2020 16:42	08/12/2020 20:20	08/12/2020 16:42	08/12/2020 20:20	3,63	2	7,26	CHI
20201241649	ITAPACI	IW12044978	ITAPACI	08/12/2020 16:42	08/12/2020 19:15	08/12/2020 16:42	08/12/2020 19:15	2,54	6	15,23	CHI
20201242655	JUSSARA	NB12117282	JUSSARA	08/12/2020 16:42	09/12/2020 08:58	08/12/2020 16:42	09/12/2020 08:58	16,25	1	16,25	CHI
20201242655	NOVO BRASIL	NB12117282	JUSSARA	08/12/2020 16:42	09/12/2020 08:58	08/12/2020 16:42	09/12/2020 08:58	16,25	12	195,05	CHI
20201242655	FAZENDA NOVA	NB12117282	JUSSARA	08/12/2020 16:42	09/12/2020 08:58	08/12/2020 16:42	09/12/2020 08:58	16,25	1	16,25	CHI
20201249696	CAIAPONIA	CP11355612	PALESTINA	08/12/2020 16:42	09/12/2020 15:26	08/12/2020 16:42	09/12/2020 15:26	22,73	1	22,73	CHI
20201241300	HIDROLANDIA	HD21007465	CEPAIGO S2	08/12/2020 16:43	08/12/2020 20:25	08/12/2020 16:43	08/12/2020 20:25	3,68	1	3,68	CHI
20201241308	RIO VERDE	RV12260603	CABRIUVA S1	08/12/2020 16:44	08/12/2020 17:10	08/12/2020 16:44	08/12/2020 17:10	0,43	5	2,16	CHI
20201241311	GOIANIA	GN11049976	REAL S2	08/12/2020 16:44	08/12/2020 18:35	08/12/2020 18:30	08/12/2020 18:35	0,08	111	9,28	CHI
20201241439	TRINDADE	CK12400459	INHUMAS S1	08/12/2020 16:44	08/12/2020 19:43	08/12/2020 16:44	08/12/2020 19:43	2,98	13	38,69	CHI
20201241439	GOIANIRA	CK12400459	INHUMAS S1	08/12/2020 16:44	08/12/2020 19:43	08/12/2020 16:44	08/12/2020 19:43	2,98	1	2,98	CHI
20201241759	PIRACANJUBA	PJ12263230	CALDAS NOVAS S1	08/12/2020 16:44	09/12/2020 12:00	08/12/2020 16:44	09/12/2020 12:00	19,26	17	327,44	CHI
20201241759	CALDAS NOVAS	PJ12263230	CALDAS NOVAS S1	08/12/2020 16:44	09/12/2020 12:00	08/12/2020 16:44	09/12/2020 12:00	19,26	1	19,26	CHI
20201241327	CRISTALINA	KR12244611	CRISTALINA S2	08/12/2020 16:45	08/12/2020 19:17	08/12/2020 16:45	08/12/2020 19:17	2,52	2	5,03	CHI
20201244741	TURVANIA	TV12005223	FIRMINOPOLIS S2	08/12/2020 16:45	09/12/2020 09:56	08/12/2020 16:45	09/12/2020 09:56	17,18	6	103,09	CHI
20201241328	RIO QUENTE	RQ21311751	RIO QUENTE	08/12/2020 16:46	08/12/2020 21:02	08/12/2020 16:46	08/12/2020 21:02	4,26	1	4,26	CHI
20201241340	FORMOSA	FA11257764	ITIQUEIRA	08/12/2020 16:47	09/12/2020 16:44	08/12/2020 16:47	09/12/2020 16:44	23,94	3	71,82	CHI
20201241495	SILVANIA	SV11056141	VIANOPOLIS	08/12/2020 16:47	09/12/2020 00:59	08/12/2020 16:47	09/12/2020 00:59	8,19	172	1407,87	CHI
20201241656	ARAGUAPAZ	AZ12042877	MOZARLANDIA	08/12/2020 16:47	08/12/2020 18:21	08/12/2020 16:47	08/12/2020 18:21	1,55	87	135,21	CHI
20201241656	MOZARLANDIA	AZ12042877	MOZARLANDIA	08/12/2020 16:47	08/12/2020 18:21	08/12/2020 16:47	08/12/2020 18:21	1,55	2	3,11	CHI
20201242863	PIRES DO RIO	PR11202883	PIRES DO RIO S1	08/12/2020 16:47	08/12/2020 20:54	08/12/2020 16:47	08/12/2020 20:54	4,10	28	114,83	CHI
20201243069	CRISTALINA	KR12101526	CRISTALINA S1	08/12/2020 16:47	08/12/2020 20:53	08/12/2020 16:47	08/12/2020 20:53	4,09	54	221,10	CHI
20201243069	LUZIANIA	KR12101526	CRISTALINA S1	08/12/2020 16:47	08/12/2020 20:53	08/12/2020 16:47	08/12/2020 20:53	4,09	27	110,55	CHI
20201241420	ARAGARCAS	AG12138460	ARAGARCAS	08/12/2020 16:48	09/12/2020 07:33	08/12/2020 16:48	09/12/2020 07:33	14,74	13	191,63	CHI
20201241427	MORRINHOS	MR12269745	MORRINHOS	08/12/2020 16:48	08/12/2020 22:14	08/12/2020 16:48	08/12/2020 22:14	5,43	11	59,70	CHI
20201241361	LUZIANIA	120449729	RIO VERMELHO	08/12/2020 16:49	09/12/2020 10:12	08/12/2020 16:49	09/12/2020 10:12	17,37	1	17,37	CHI
20201242217	JUSSARA	JR12019314	JUSSARA	08/12/2020 16:49	08/12/2020 21:16	08/12/2020 16:49	08/12/2020 21:16	4,44	83	368,36	CHI
20201241556	NIQUELANDIA	NQ12235223	NIQUELANDIA SUBTRANSMISSAO	08/12/2020 16:50	08/12/2020 20:04	08/12/2020 16:50	08/12/2020 20:04	3,22	27	87,02	CHI
20201241375	CALDAS NOVAS	CN11244611	SERRA DE CALDAS	08/12/2020 16:51	09/12/2020 03:09	08/12/2020 16:51	09/12/2020 03:09	10,29	51	524,95	CHI
20201241378	RIO VERDE	RV12076308	CACHOEIRA ALTA	08/12/2020 16:51	09/12/2020 11:06	08/12/2020 16:51	09/12/2020 11:06	18,24	1	18,24	CHI
20201242031	JUSSARA	JR12101204	JUSSARA	08/12/2020 16:51	08/12/2020 23:31	08/12/2020 16:51	08/12/2020 23:31	6,66	30	199,76	CHI
20201241383	GOIANIA	GN21001782	REAL S1	08/12/2020 16:52	08/12/2020 20:38	08/12/2020 16:52	08/12/2020 20:38	3,77	1	3,77	CHI
20201241386	CORUMBAIBA	CI12000463RE	VILA CORUMBA	08/12/2020 16:52	08/12/2020 22:48	08/12/2020 16:52	08/12/2020 22:48	5,93	135	800,66	CHI
20201241388	JUSSARA	JR11167550	JUSSARA	08/12/2020 16:52	09/12/2020 04:18	08/12/2020 16:52	09/12/2020 04:18	11,43	206	2354,47	CHI
20201242505	BURITI ALEGRE	BG12039116	ITUMBIARA VELHA S2	08/12/2020 16:52	09/12/2020 09:04	08/12/2020 16:52	09/12/2020 09:04	16,19	10	161,87	CHI
20201243081	ALEXANIA	AX12295615	ALEXANIA	08/12/2020 16:52	09/12/2020 01:19	08/12/2020 16:52	09/12/2020 01:19	8,44	5	42,21	CHI
20201241405	RIO VERDE	RV21020031	CABRIUVA S2	08/12/2020 16:53	09/12/2020 10:03	08/12/2020 16:53	09/12/2020 10:03	17,15	1	17,15	CHI
20201241796	DAMOLANDIA	DL12272347LD	INHUMAS S1	08/12/2020 16:53	08/12/2020 21:00	08/12/2020 16:53	08/12/2020 21:00	4,10	14	57,40	CHI
20201241796	OURO VERDE DE GOIAS	DL12272347LD	INHUMAS S1	08/12/2020 16:53	08/12/2020 21:00	08/12/2020 16:53	08/12/2020 21:00	4,10	110	451,03	CHI
20201241410	RIO VERDE	RV11217554	JATAI S2	08/12/2020 16:54	08/12/2020 21:12	08/12/2020 16:54	08/12/2020 21:12	4,29	1	4,29	CHI

20201241426	POSSE	PS12302641	IACIARA S2	08/12/2020 16:54	08/12/2020 19:31	08/12/2020 16:54	08/12/2020 19:31	2,60	2	5,20	CHI
20201241306	ANAPOLIS	AN11023338	ANAPOLIS UNIVERSITARIO S2	08/12/2020 16:55	08/12/2020 18:03	08/12/2020 16:55	08/12/2020 18:03	1,12	158	177,66	CHI
20201241473	IPAMERI	IP12275811	IPAMERI	08/12/2020 16:55	08/12/2020 18:17	08/12/2020 16:55	08/12/2020 18:17	1,35	88	119,02	CHI
20201242785	CORUMBA DE GOIAS	AX12000154	CORUMBA	08/12/2020 16:55	08/12/2020 21:46	08/12/2020 16:55	08/12/2020 21:46	4,85	4	19,40	CHI
20201242785	ALEXANIA	AX12000154	CORUMBA	08/12/2020 16:55	08/12/2020 21:46	08/12/2020 16:55	08/12/2020 21:46	4,85	22	106,68	CHI
20201242951	QUIRINOPOLIS	QI12107380	QUIRINOPOLIS	08/12/2020 16:55	08/12/2020 21:47	08/12/2020 16:55	08/12/2020 21:47	4,85	3	14,56	CHI
20201241447	CALDAS NOVAS	CN11142402	SERRA DE CALDAS	08/12/2020 16:56	08/12/2020 19:20	08/12/2020 16:56	08/12/2020 19:20	2,39	72	172,10	CHI
20201241448	CABECEIRAS	CW21157340	ITUIQUIRA	08/12/2020 16:56	09/12/2020 11:33	08/12/2020 16:56	09/12/2020 11:33	18,61	1	18,61	CHI
20201241454	MORRINHOS	MR12239049	MORRINHOS	08/12/2020 16:57	09/12/2020 02:21	08/12/2020 16:57	09/12/2020 02:21	9,40	3	28,20	CHI
20201241465	INDIARA	JD12223592	PALMEIRAS	08/12/2020 16:57	09/12/2020 07:01	08/12/2020 16:57	09/12/2020 07:01	14,05	5	70,26	CHI
20201241465	PALMEIRAS DE GOIAS	JD12223592	PALMEIRAS	08/12/2020 16:57	09/12/2020 07:01	08/12/2020 16:57	09/12/2020 07:01	14,05	2	28,11	CHI
20201243013	SAO JOAO D ALIANCA	JL11014772	SAO JOAO D ALIANCA	08/12/2020 16:57	09/12/2020 12:33	08/12/2020 16:57	09/12/2020 12:33	19,60	43	842,62	CHI
20201243104	ALEXANIA	AX12211846	ALEXANIA	08/12/2020 16:57	08/12/2020 20:28	08/12/2020 16:57	08/12/2020 20:28	3,51	229	803,15	CHI
20201242930	RIO VERDE	RV12230656	CABRIUVA S2	08/12/2020 16:58	09/12/2020 14:02	08/12/2020 16:58	09/12/2020 00:58	8,00	9	72,01	CHI
20201242930	RIO VERDE	RV12230656	CABRIUVA S2	08/12/2020 16:58	09/12/2020 14:02	09/12/2020 00:59	09/12/2020 14:02	13,06	9	117,50	CHI
20201242489	ITAUCU	AR12200075	ARACU	08/12/2020 16:59	09/12/2020 07:15	08/12/2020 16:59	09/12/2020 07:15	14,27	6	85,63	CHI
20201242489	INHUMAS	AR12200075	ARACU	08/12/2020 16:59	09/12/2020 07:15	08/12/2020 16:59	09/12/2020 07:15	14,27	25	356,78	CHI
20201242489	ARACU	AR12200075	ARACU	08/12/2020 16:59	09/12/2020 07:15	08/12/2020 16:59	09/12/2020 07:15	14,27	238	3396,52	CHI
20201241490	GOIANIA	14377779	CAMPINAS S2	08/12/2020 17:00	09/12/2020 11:03	08/12/2020 17:00	09/12/2020 11:03	18,04	1	18,04	CHI
20201241986	JATAI	JT12377830	JATAI S1	08/12/2020 17:00	09/12/2020 15:00	08/12/2020 17:00	09/12/2020 15:00	22,00	9	197,98	CHI
20201241500	SANTA FE DE GOIAS	RN12009765	BRITANIA	08/12/2020 17:01	08/12/2020 21:45	08/12/2020 17:01	08/12/2020 21:45	4,72	22	103,91	CHI
20201241506	SAO LUIS DE MONTES BELOS	500098657	SAO LUIZ DOS MONTES BELOS	08/12/2020 17:02	08/12/2020 20:54	08/12/2020 17:02	08/12/2020 20:54	3,86	1	3,86	CHI
20201241519	SANTA HELENA DE GOIAS	RV21103897	RIO VERDE S1	08/12/2020 17:03	09/12/2020 00:23	08/12/2020 17:03	09/12/2020 00:23	7,33	1	7,33	CHI
20201241522	LUZIANIA	LZ21261348	MARAJOARA	08/12/2020 17:03	08/12/2020 22:13	08/12/2020 17:03	08/12/2020 22:13	5,16	2	10,31	CHI
20201241609	NOVA CRIXAS	CX12221633RE	RUBIATABA	08/12/2020 17:03	09/12/2020 10:11	08/12/2020 17:03	09/12/2020 10:11	17,12	1	17,12	CHI
20201241609	CRIXAS	CX12221633RE	RUBIATABA	08/12/2020 17:03	09/12/2020 10:11	08/12/2020 17:03	09/12/2020 10:11	17,12	133	2276,59	CHI
20201241948	CALDAS NOVAS	CN12214041	SERRA DE CALDAS	08/12/2020 17:03	08/12/2020 18:19	08/12/2020 17:03	08/12/2020 18:19	1,27	585	740,35	CHI
20201241530	MINEIROS	MY21036201	PARQUE DAS EMAS	08/12/2020 17:04	09/12/2020 02:18	08/12/2020 17:04	09/12/2020 02:18	9,24	1	9,24	CHI
20201241543	ALEXANIA	AX12328290LD	ALEXANIA	08/12/2020 17:04	09/12/2020 11:52	08/12/2020 17:04	09/12/2020 11:52	18,80	11	206,78	CHI
20201241976	PARAUNA	PU12301167	ACREUNA	08/12/2020 17:05	08/12/2020 20:45	08/12/2020 17:05	08/12/2020 20:45	3,66	14	51,28	CHI
20201243840	MINEIROS	MY11264731	PARQUE DAS EMAS	08/12/2020 17:05	09/12/2020 00:08	08/12/2020 17:05	09/12/2020 00:08	7,06	153	1079,92	CHI
20201241562	CABECEIRAS	CW21184542	ITUIQUIRA	08/12/2020 17:06	09/12/2020 17:17	08/12/2020 17:06	09/12/2020 17:17	24,18	2	48,36	CHI
20201241573	CALDAS NOVAS	CN12246620	SERRA DE CALDAS	08/12/2020 17:06	08/12/2020 18:21	08/12/2020 17:06	08/12/2020 18:21	1,24	1057	1312,44	CHI
20201242310	CORUMBAIBA	CI11054936	VILA CORUMBA	08/12/2020 17:06	09/12/2020 01:50	08/12/2020 17:06	09/12/2020 01:50	8,72	164	1430,40	CHI
20201241575	QUIRINOPOLIS	10019102893	QUIRINOPOLIS	08/12/2020 17:07	08/12/2020 21:56	08/12/2020 17:07	08/12/2020 21:56	4,81	1	4,81	CHI
20201241581	CACHOEIRA ALTA	10030163828	CACHOEIRA ALTA	08/12/2020 17:07	08/12/2020 21:13	08/12/2020 17:07	08/12/2020 21:13	4,09	1	4,09	CHI
20201241582	JARAGUA	JA21027789	GOIANESIA S2	08/12/2020 17:07	08/12/2020 22:06	08/12/2020 17:07	08/12/2020 22:06	4,97	1	4,97	CHI
20201241583	JATAI	JT21138899	JATAI S2	08/12/2020 17:07	09/12/2020 11:22	08/12/2020 17:07	09/12/2020 11:22	18,24	1	18,24	CHI
20201241913	CALDAS NOVAS	CN12204407	SERRA DE CALDAS	08/12/2020 17:07	09/12/2020 12:15	08/12/2020 17:07	09/12/2020 12:15	19,13	2	38,27	CHI
20201241588	SAO SIMAO	SO21338612	CACHOEIRA ALTA	08/12/2020 17:08	09/12/2020 01:26	08/12/2020 17:08	09/12/2020 01:26	8,30	1	8,30	CHI
20201242781	PALMEIRAS DE GOIAS	PL12308411	PALMEIRAS	08/12/2020 17:08	08/12/2020 21:25	08/12/2020 17:08	08/12/2020 21:25	4,28	172	736,02	CHI
20201241597	CACHOEIRA ALTA	CA21196156	CACHOEIRA ALTA	08/12/2020 17:09	08/12/2020 19:32	08/12/2020 17:09	08/12/2020 19:32	2,37	1	2,37	CHI
20201241811	APORE	3110005321	ITAJA S1	08/12/2020 17:09	09/12/2020 08:10	08/12/2020 17:09	09/12/2020 08:10	15,02	1	15,02	CHI
20201241621	MINEIROS	MY12260468	PARQUE DAS EMAS	08/12/2020 17:11	08/12/2020 21:31	08/12/2020 17:11	08/12/2020 21:31	4,32	5	21,62	CHI
20201241622	GOIANIA	GN11169915	ATLANTICO S3	08/12/2020 17:11	08/12/2020 20:11	08/12/2020 17:11	08/12/2020 20:11	2,99	45	134,55	CHI
20201241623	ITABERAI	IB21307604	ITABERAI S1	08/12/2020 17:11	09/12/2020 11:33	08/12/2020 17:11	09/12/2020 11:33	18,35	1	18,35	CHI
20201241625	SILVANIA	SV11274201	VIANOPOLIS	08/12/2020 17:11	09/12/2020 02:43	08/12/2020 17:11	09/12/2020 02:43	9,52	144	1371,08	CHI
20201241630	CATALAO	CT11215495	CATALAO S1	08/12/2020 17:12	08/12/2020 20:31	08/12/2020 17:12	08/12/2020 20:31	3,31	176	583,05	CHI
20201242818	CABECEIRAS	CW12403588	ITUIQUIRA	08/12/2020 17:12	09/12/2020 14:19	08/12/2020 17:12	09/12/2020 14:19	21,12	7	147,81	CHI
20201245451	FAZENDA NOVA	FN12033218RE	IPORA	08/12/2020 17:12	09/12/2020 08:52	08/12/2020 17:12	09/12/2020 08:52	15,65	33	516,51	CHI
20201245451	ISRAELANDIA	FN12033218RE	IPORA	08/12/2020 17:12	09/12/2020 08:52	08/12/2020 17:12	09/12/2020 08:52	15,65	11	172,17	CHI

20201241742	CORUMBAIBA	CI12025121	VILA CORUMBA	08/12/2020 17:14	09/12/2020 08:30	08/12/2020 17:14	09/12/2020 08:30	15,26	35	534,23	CHI
20201241667	GOIANESIA	BA12163310	GOIANESIA S1	08/12/2020 17:15	08/12/2020 20:19	08/12/2020 17:15	08/12/2020 20:19	3,07	2	6,13	CHI
20201241676	JOVIANIA	570002072	GOIATUBA S1	08/12/2020 17:15	09/12/2020 11:28	08/12/2020 17:15	09/12/2020 11:28	18,20	1	18,20	CHI
20201242107	ANAPOLIS	AN12000524	ANAPOLIS UNIVERSITARIO S2	08/12/2020 17:15	08/12/2020 22:40	08/12/2020 17:15	08/12/2020 22:40	5,41	5	27,07	CHI
20201241689	VALPARAISO DE GOIAS	10029279230	MARAJOARA	08/12/2020 17:16	08/12/2020 23:28	08/12/2020 17:16	08/12/2020 23:28	6,19	1	6,19	CHI
20201243953	CAMPO ALEGRE DE GOIAS	CM12281443LD	CAMPO ALEGRE DE GOIAS	08/12/2020 17:17	09/12/2020 13:49	08/12/2020 17:17	09/12/2020 13:49	20,55	14	287,67	CHI
20201243953	IPAMERI	CM12281443LD	CAMPO ALEGRE DE GOIAS	08/12/2020 17:17	09/12/2020 13:49	08/12/2020 17:17	09/12/2020 13:49	20,55	1	20,55	CHI
20201242276	GOIANIA	GN11001385	CAMPINAS S2	08/12/2020 17:18	08/12/2020 20:19	08/12/2020 17:18	08/12/2020 20:19	3,02	180	542,85	CHI
20201243265	FAINA	FC12096060	GOIAS	08/12/2020 17:18	08/12/2020 20:02	08/12/2020 17:18	08/12/2020 20:02	2,72	124	337,83	CHI
20201243265	ARAGUAPAZ	FC12096060	GOIAS	08/12/2020 17:18	08/12/2020 20:02	08/12/2020 17:18	08/12/2020 20:02	2,72	2	5,45	CHI
20201241713	DISTRITO FEDERAL	SN13286432	MARAJOARA	08/12/2020 17:19	08/12/2020 17:56	08/12/2020 17:19	08/12/2020 17:56	0,61	3	1,82	CHI
20201241713	SANTO ANTONIO DO DESCOBERTO	SN13286432	MARAJOARA	08/12/2020 17:19	08/12/2020 17:56	08/12/2020 17:19	08/12/2020 17:56	0,61	518	313,97	CHI
20201241713	ALEXANIA	SN13286432	MARAJOARA	08/12/2020 17:19	08/12/2020 17:56	08/12/2020 17:19	08/12/2020 17:56	0,61	6	3,64	CHI
20201241869	EDEALINA	ED12257974	PONTALINA	08/12/2020 17:19	09/12/2020 05:14	08/12/2020 17:19	09/12/2020 05:14	11,91	4	47,63	CHI
20201241731	ANAPOLIS	20156420	JUNDIAI S1	08/12/2020 17:21	08/12/2020 22:46	08/12/2020 17:21	08/12/2020 22:46	5,41	1	5,41	CHI
20201243448	CALDAS NOVAS	CN12354085	SERRA DE CALDAS	08/12/2020 17:21	08/12/2020 20:53	08/12/2020 17:21	08/12/2020 20:53	3,53	244	860,30	CHI
20201241981	FAINA	FC12038664	GOIAS	08/12/2020 17:22	08/12/2020 21:48	08/12/2020 17:22	08/12/2020 21:48	4,42	10	44,18	CHI
20201243090	GOIANDIRA	GD10416020	CATALAO S1	08/12/2020 17:22	08/12/2020 18:40	08/12/2020 17:22	08/12/2020 18:40	1,31	965	1266,03	CHI
20201243099	ALEXANIA	AX12000109	CORUMBA	08/12/2020 17:22	09/12/2020 00:24	08/12/2020 17:22	09/12/2020 00:24	7,02	7	49,13	CHI
20201243099	CORUMBA DE GOIAS	AX12000109	CORUMBA	08/12/2020 17:22	09/12/2020 00:24	08/12/2020 17:22	09/12/2020 00:24	7,02	4	28,08	CHI
20201241761	GOIATUBA	JV21159152	GOIATUBA S1	08/12/2020 17:23	09/12/2020 17:13	08/12/2020 17:23	09/12/2020 17:13	23,82	1	23,82	CHI
20201242500	PIRES DO RIO	PR12000094	PIRES DO RIO S1	08/12/2020 17:25	08/12/2020 20:05	08/12/2020 17:25	08/12/2020 20:05	2,66	22	58,61	CHI
20201241784	SENADOR CANEDO	10008567970	SENADOR CANEDO	08/12/2020 17:26	09/12/2020 00:47	08/12/2020 17:26	09/12/2020 00:47	7,35	1	7,35	CHI
20201241795	FAINA	FC12096433	GOIAS	08/12/2020 17:26	10/12/2020 10:31	08/12/2020 17:26	10/12/2020 10:31	41,07	1	41,07	CHI
20201241813	TRINDADE	GR21129671	TRINDADE	08/12/2020 17:27	08/12/2020 22:25	08/12/2020 17:27	08/12/2020 22:25	4,97	3	14,91	CHI
20201242666	LUZIANIA	LZ12061391	MARAJOARA	08/12/2020 17:27	08/12/2020 20:59	08/12/2020 17:27	08/12/2020 20:59	3,52	76	267,67	CHI
20201242835	CROMINIA	CQ12079894	PONTALINA	08/12/2020 17:27	08/12/2020 23:55	08/12/2020 17:27	08/12/2020 23:55	6,46	2	12,92	CHI
20201241829	CALDAS NOVAS	CN12223541	SERRA DE CALDAS	08/12/2020 17:28	08/12/2020 19:20	08/12/2020 17:28	08/12/2020 19:20	1,85	193	357,37	CHI
20201242445	BELA VISTA DE GOIAS	BV12402718	BELA VISTA S1	08/12/2020 17:28	08/12/2020 20:41	08/12/2020 17:28	08/12/2020 20:41	3,20	13	41,63	CHI
20201242673	FORMOSA	FA16404015	ITIQUEIRA	08/12/2020 17:28	08/12/2020 19:42	08/12/2020 17:28	08/12/2020 19:10	1,71	2510	4295,59	CHI
20201242673	FORMOSA	FA16404015	ITIQUEIRA	08/12/2020 17:28	08/12/2020 19:42	08/12/2020 19:07	08/12/2020 19:10	0,06	88	5,18	CHI
20201242673	FORMOSA	FA16408138	ITIQUEIRA	08/12/2020 17:28	08/12/2020 19:42	08/12/2020 17:28	08/12/2020 19:12	1,73	314	544,62	CHI
20201242673	FORMOSA	FA16404015	ITIQUEIRA	08/12/2020 17:28	08/12/2020 19:42	08/12/2020 17:28	08/12/2020 19:13	1,76	463	816,42	CHI
20201242673	FORMOSA	FA16404015	ITIQUEIRA	08/12/2020 17:28	08/12/2020 19:42	08/12/2020 17:28	08/12/2020 19:42	2,24	4022	9001,46	CHI
20201242673	FORMOSA	FA16416903	ITIQUEIRA	08/12/2020 17:28	08/12/2020 19:42	08/12/2020 17:28	08/12/2020 19:42	2,24	947	2119,44	CHI
20201244505	NIQUELANDIA	NQ12218976LD	URUACU	08/12/2020 17:28	09/12/2020 04:19	08/12/2020 17:28	09/12/2020 04:19	10,84	72	780,74	CHI
20201241858	RIO VERDE	10032766252	RIO VERDE S2	08/12/2020 17:31	09/12/2020 10:29	08/12/2020 17:31	09/12/2020 10:29	16,96	1	16,96	CHI
20201241863	CRISTALINA	KR21171020	CRISTALINA S1	08/12/2020 17:31	08/12/2020 23:01	08/12/2020 17:31	08/12/2020 23:01	5,49	1	5,49	CHI
20201241873	JATAI	JT18000231TS	JATAI S1	08/12/2020 17:31	09/12/2020 00:53	08/12/2020 17:31	09/12/2020 00:53	7,35	73	536,65	CHI
20201241873	PEROLANDIA	JT18000231TS	JATAI S1	08/12/2020 17:31	09/12/2020 00:53	08/12/2020 17:31	09/12/2020 00:53	7,35	3	22,05	CHI
20201241877	CIDADE OCIDENTAL	DH12415607LD	MARAJOARA	08/12/2020 17:32	09/12/2020 02:14	08/12/2020 17:32	09/12/2020 02:14	8,69	1	8,69	CHI
20201242165	CALDAS NOVAS	CN11076979	SERRA DE CALDAS	08/12/2020 17:32	08/12/2020 18:42	08/12/2020 17:32	08/12/2020 18:42	1,16	122	141,86	CHI
20201243000	CALDAS NOVAS	CN11200084	CALDAS NOVAS S1	08/12/2020 17:32	08/12/2020 22:48	08/12/2020 17:32	08/12/2020 22:48	5,25	73	383,53	CHI
20201243335	JATAI	JT12260304	JATAI S2	08/12/2020 17:32	09/12/2020 22:38	08/12/2020 17:32	09/12/2020 22:38	29,11	36	1047,83	CHI
20201241884	ARAGUAPAZ	AZ12030331	GOIAS	08/12/2020 17:33	08/12/2020 20:49	08/12/2020 17:33	08/12/2020 20:49	3,26	2	6,53	CHI
20201245111	FAINA	FC12061009	GOIAS	08/12/2020 17:33	09/12/2020 10:09	08/12/2020 17:33	09/12/2020 10:09	16,59	17	282,05	CHI
20201241904	PIRENOPOLIS	PV21185574	CORUMBA	08/12/2020 17:34	08/12/2020 23:30	08/12/2020 17:34	08/12/2020 23:30	5,92	2	11,85	CHI
20201242887	ITAPURANGA	IK12249439	ITAPURANGA	08/12/2020 17:34	08/12/2020 21:13	08/12/2020 17:34	08/12/2020 21:13	3,64	615	2239,97	CHI
20201241919	VILA PROPICIO	NP12298237	GOIANESIA S1	08/12/2020 17:35	09/12/2020 14:09	08/12/2020 17:35	09/12/2020 14:09	20,55	1	20,55	CHI
20201241920	CATALAO	1990049646	CATALAO S2	08/12/2020 17:35	08/12/2020 19:30	08/12/2020 17:35	08/12/2020 19:30	1,90	1	1,90	CHI
20201241923	GOIANIA	GN12000805	XAVANTES	08/12/2020 17:36	08/12/2020 20:59	08/12/2020 17:36	08/12/2020 20:59	3,38	15	50,75	CHI

20201241929	COLINAS DO SUL	9700008611	NIQUELANDIA SUBTRANSMISSAO	08/12/2020 17:36	09/12/2020 03:53	08/12/2020 17:36	09/12/2020 03:53	10,28	1	10,28	CHI
20201241935	RIO VERDE	RV18214126TS	RIO VERDE S1	08/12/2020 17:36	08/12/2020 23:39	08/12/2020 17:36	08/12/2020 23:39	6,04	73	440,72	CHI
20201241935	SANTA HELENA DE GOIAS	RV18214126TS	RIO VERDE S1	08/12/2020 17:36	08/12/2020 23:39	08/12/2020 17:36	08/12/2020 23:39	6,04	46	277,71	CHI
20201242044	NOVA AMERICA	NM12077844	RUBIATABA	08/12/2020 17:36	08/12/2020 20:59	08/12/2020 17:36	08/12/2020 20:59	3,38	22	74,26	CHI
20201241280	CAIAPONIA	CP11355609	PALESTINA	08/12/2020 17:37	09/12/2020 14:00	08/12/2020 17:37	09/12/2020 14:00	20,38	1	20,38	CHI
20201241941	CALDAS NOVAS	CN21000222	RIO QUENTE	08/12/2020 17:37	08/12/2020 20:47	08/12/2020 17:37	08/12/2020 20:47	3,16	1	3,16	CHI
20201242150	VIANOPOLIS	VN12014680	VIANOPOLIS	08/12/2020 17:37	09/12/2020 16:05	08/12/2020 17:37	09/12/2020 16:05	22,45	11	247,00	CHI
20201242710	MONTIVIDIU	MV13305748	MONTIVIDIU T	08/12/2020 17:37	10/12/2020 15:22	08/12/2020 17:37	08/12/2020 20:28	2,83	20	56,69	CHI
20201242710	RIO VERDE	MV13305748	MONTIVIDIU T	08/12/2020 17:37	10/12/2020 15:22	08/12/2020 17:37	08/12/2020 20:28	2,83	46	130,40	CHI
20201242710	CAIAPONIA	MV12054336	MONTIVIDIU T	08/12/2020 17:37	10/12/2020 15:22	08/12/2020 17:37	08/12/2020 23:00	5,37	40	214,72	CHI
20201242710	RIO VERDE	MV12054336	MONTIVIDIU T	08/12/2020 17:37	10/12/2020 15:22	08/12/2020 17:37	08/12/2020 23:00	5,37	1	5,37	CHI
20201242710	MONTIVIDIU	MV12054336	MONTIVIDIU T	08/12/2020 17:37	10/12/2020 15:22	08/12/2020 17:37	08/12/2020 23:00	5,37	35	187,88	CHI
20201242710	CAIAPONIA	MV10400640	MONTIVIDIU T	08/12/2020 17:37	10/12/2020 15:22	09/12/2020 10:16	09/12/2020 10:42	0,42	6	2,54	CHI
20201242710	MONTIVIDIU	MV10400640	MONTIVIDIU T	08/12/2020 17:37	10/12/2020 15:22	09/12/2020 10:16	09/12/2020 10:42	0,42	55	23,27	CHI
20201242710	RIO VERDE	MV10400640	MONTIVIDIU T	08/12/2020 17:37	10/12/2020 15:22	09/12/2020 10:16	09/12/2020 10:42	0,42	47	19,88	CHI
20201242710	CAIAPONIA	MV10400640	MONTIVIDIU T	08/12/2020 17:37	10/12/2020 15:22	09/12/2020 15:34	09/12/2020 15:45	0,19	6	1,13	CHI
20201242710	MONTIVIDIU	MV10400640	MONTIVIDIU T	08/12/2020 17:37	10/12/2020 15:22	09/12/2020 15:34	09/12/2020 15:45	0,19	55	10,33	CHI
20201242710	RIO VERDE	MV10400640	MONTIVIDIU T	08/12/2020 17:37	10/12/2020 15:22	09/12/2020 15:34	09/12/2020 15:45	0,19	47	8,83	CHI
20201242710	CAIAPONIA	MV12054336	MONTIVIDIU T	08/12/2020 17:37	10/12/2020 15:22	08/12/2020 17:37	09/12/2020 18:10	24,54	6	147,21	CHI
20201242710	CAIAPONIA	MV12054336	MONTIVIDIU T	08/12/2020 17:37	10/12/2020 15:22	08/12/2020 17:37	10/12/2020 11:47	42,16	1	42,16	CHI
20201242710	CAIAPONIA	MV12054336	MONTIVIDIU T	08/12/2020 17:37	10/12/2020 15:22	08/12/2020 17:37	10/12/2020 12:31	42,89	41	1758,47	CHI
20201242710	CAIAPONIA	MV12054336	MONTIVIDIU T	08/12/2020 17:37	10/12/2020 15:22	08/12/2020 17:37	10/12/2020 14:51	45,22	5	226,12	CHI
20201242710	CAIAPONIA	MV12054336	MONTIVIDIU T	08/12/2020 17:37	10/12/2020 15:22	08/12/2020 17:37	10/12/2020 15:22	45,74	4	182,96	CHI
20201241949	PALMEIRAS DE GOIAS	PP12233536	PALMEIRAS	08/12/2020 17:38	09/12/2020 09:14	08/12/2020 17:38	09/12/2020 09:14	15,60	11	171,55	CHI
20201241949	PALMINOPOLIS	PP12233536	PALMEIRAS	08/12/2020 17:38	09/12/2020 09:14	08/12/2020 17:38	09/12/2020 09:14	15,60	1	15,60	CHI
20201242588	CIDADE OCIDENTAL	DH12170612	MARAJOARA	08/12/2020 17:38	08/12/2020 22:26	08/12/2020 17:38	08/12/2020 22:26	4,79	15	71,92	CHI
20201243372	GOIANIA	GN11337907	GOYA S1	08/12/2020 17:39	09/12/2020 00:57	08/12/2020 17:39	09/12/2020 00:57	7,28	106	772,09	CHI
20201241967	MONTES CLAROS DE GOIAS	ME21135465	IPORA	08/12/2020 17:40	08/12/2020 19:35	08/12/2020 17:40	08/12/2020 19:35	1,91	1	1,91	CHI
20201242188	ITARUMA	03700214	CACHOEIRA ALTA	08/12/2020 17:40	09/12/2020 17:37	08/12/2020 17:40	08/12/2020 20:54	3,23	25	80,65	CHI
20201242188	ITARUMA	IM13182027	CACHOEIRA ALTA	08/12/2020 17:40	09/12/2020 17:37	08/12/2020 17:40	08/12/2020 22:03	4,38	8	35,01	CHI
20201242188	ITARUMA	03700214	CACHOEIRA ALTA	08/12/2020 17:40	09/12/2020 17:37	09/12/2020 00:03	09/12/2020 02:29	2,43	33	80,08	CHI
20201242188	ITARUMA	IM13348172	CACHOEIRA ALTA	08/12/2020 17:40	09/12/2020 17:37	08/12/2020 17:40	09/12/2020 11:08	17,47	1	17,47	CHI
20201242188	LAGOA SANTA	03700414	CACHOEIRA ALTA	08/12/2020 17:40	09/12/2020 17:37	09/12/2020 12:48	09/12/2020 13:51	1,05	17	17,91	CHI
20201242188	ITAJA	03700414	CACHOEIRA ALTA	08/12/2020 17:40	09/12/2020 17:37	09/12/2020 12:48	09/12/2020 13:51	1,05	7	7,37	CHI
20201242188	ITARUMA	03700414	CACHOEIRA ALTA	08/12/2020 17:40	09/12/2020 17:37	09/12/2020 12:48	09/12/2020 13:51	1,05	6	6,32	CHI
20201242188	ITAJA	03700414	CACHOEIRA ALTA	08/12/2020 17:40	09/12/2020 17:37	09/12/2020 12:48	09/12/2020 13:51	1,05	41	43,19	CHI
20201242188	ITARUMA	03700414	CACHOEIRA ALTA	08/12/2020 17:40	09/12/2020 17:37	09/12/2020 12:48	09/12/2020 13:51	1,05	33	34,76	CHI
20201242188	CACU	03700414	CACHOEIRA ALTA	08/12/2020 17:40	09/12/2020 17:37	09/12/2020 12:48	09/12/2020 13:51	1,05	55	57,93	CHI
20201242188	ITARUMA	03700414	CACHOEIRA ALTA	08/12/2020 17:40	09/12/2020 17:37	09/12/2020 12:48	09/12/2020 13:51	1,05	81	85,32	CHI
20201242188	ITARUMA	IM13348172	CACHOEIRA ALTA	08/12/2020 17:40	09/12/2020 17:37	08/12/2020 17:40	09/12/2020 17:37	23,95	10	239,47	CHI
20201242188	ITARUMA	IM13348172	CACHOEIRA ALTA	08/12/2020 17:40	09/12/2020 17:37	09/12/2020 12:48	09/12/2020 17:37	4,82	1	4,82	CHI
20201242144	CORUMBA DE GOIAS	PV12295561	CORUMBA	08/12/2020 17:42	09/12/2020 12:10	08/12/2020 17:42	09/12/2020 12:10	18,46	4	73,82	CHI
20201242144	PIRENOPOLIS	PV12295561	CORUMBA	08/12/2020 17:42	09/12/2020 12:10	08/12/2020 17:42	09/12/2020 12:10	18,46	31	572,11	CHI
20201242591	INHUMAS	IN11057724	INHUMAS S2	08/12/2020 17:42	08/12/2020 19:08	08/12/2020 17:42	08/12/2020 19:08	1,42	113	160,77	CHI
20201245178	CIDADE OCIDENTAL	DH11261053	MARAJOARA	08/12/2020 17:42	09/12/2020 07:39	08/12/2020 17:42	09/12/2020 07:39	13,95	44	613,67	CHI
2020120800160	CRISTALINA	PMP-TR2	PAMPLONA	08/12/2020 17:43	08/12/2020 17:52	08/12/2020 17:43	08/12/2020 17:51	0,14	205	27,79	CHI
2020120800160	LUZIANIA	PMP-TR2	PAMPLONA	08/12/2020 17:43	08/12/2020 17:52	08/12/2020 17:43	08/12/2020 17:51	0,14	10	1,36	CHI
2020120800160	LUZIANIA	PMP-TR2	PAMPLONA	08/12/2020 17:43	08/12/2020 17:52	08/12/2020 17:43	08/12/2020 17:51	0,14	6	0,81	CHI
2020120800160	CRISTALINA	PMP-TR2	PAMPLONA	08/12/2020 17:43	08/12/2020 17:52	08/12/2020 17:43	08/12/2020 17:51	0,14	6	0,81	CHI
2020120800160	CRISTALINA	PMP-TR2	PAMPLONA	08/12/2020 17:43	08/12/2020 17:52	08/12/2020 17:43	08/12/2020 17:51	0,14	2557	346,62	CHI
2020120800160	LUZIANIA	PMP-TR1	PAMPLONA	08/12/2020 17:43	08/12/2020 17:52	08/12/2020 17:43	08/12/2020 17:52	0,14	78	11,16	CHI

2020120800160	CRISTALINA	PMP-TR1	PAMPLONA	08/12/2020 17:43	08/12/2020 17:52	08/12/2020 17:43	08/12/2020 17:52	0,14	199	28,47	CHI
2020120800160	LUZIANIA	PMP-TR1	PAMPLONA	08/12/2020 17:43	08/12/2020 17:52	08/12/2020 17:43	08/12/2020 17:52	0,14	2	0,29	CHI
2020120800160	CRISTALINA	PMP-TR1	PAMPLONA	08/12/2020 17:43	08/12/2020 17:52	08/12/2020 17:43	08/12/2020 17:52	0,14	48	6,87	CHI
2020120800160	CRISTALINA	PMP-TR1	PAMPLONA	08/12/2020 17:43	08/12/2020 17:52	08/12/2020 17:43	08/12/2020 17:52	0,14	138	19,74	CHI
2020120800160	DISTRITO FEDERAL	PMP-TR1	PAMPLONA	08/12/2020 17:43	08/12/2020 17:52	08/12/2020 17:43	08/12/2020 17:52	0,14	2	0,29	CHI
2020120800160	CRISTALINA	PMP-TR1	PAMPLONA	08/12/2020 17:43	08/12/2020 17:52	08/12/2020 17:44	08/12/2020 17:52	0,13	2	0,26	CHI
2020120800160	CRISTALINA	PMP-TR1	PAMPLONA	08/12/2020 17:43	08/12/2020 17:52	08/12/2020 17:44	08/12/2020 17:52	0,13	1	0,13	CHI
2020120800160	CRISTALINA	PMP-TR1	PAMPLONA	08/12/2020 17:43	08/12/2020 17:52	08/12/2020 17:44	08/12/2020 17:52	0,13	5	0,64	CHI
20201242018	TRINDADE	TR31041033	TRINDADE	08/12/2020 17:44	08/12/2020 21:20	08/12/2020 17:44	08/12/2020 21:20	3,59	2	7,18	CHI
20201242019	SAO LUIS DE MONTES BELOS	SL12098054	SAO LUIZ DOS MONTES BELOS	08/12/2020 17:44	09/12/2020 12:04	08/12/2020 17:44	09/12/2020 12:04	18,32	3	54,97	CHI
20201242030	GOIANESIA	550166063	GOIANESIA S2	08/12/2020 17:45	09/12/2020 02:35	08/12/2020 17:45	09/12/2020 02:35	8,82	1	8,82	CHI
20201242041	GOIANIA	16293101	MEIA PONTE	08/12/2020 17:47	08/12/2020 22:32	08/12/2020 17:47	08/12/2020 22:32	4,74	1	4,74	CHI
20201242049	AGUA LIMPA	MG12120778	VILA CORUMBA	08/12/2020 17:47	09/12/2020 12:39	08/12/2020 17:47	09/12/2020 12:39	18,86	16	301,77	CHI
20201242049	MARZAGAO	MG12120778	VILA CORUMBA	08/12/2020 17:47	09/12/2020 12:39	08/12/2020 17:47	09/12/2020 12:39	18,86	2	37,72	CHI
20201242130	SENADOR CANEDO	SW12393265	SENADOR CANEDO	08/12/2020 17:47	08/12/2020 19:56	08/12/2020 17:47	08/12/2020 19:56	2,14	440	943,43	CHI
20201242206	SENADOR CANEDO	GN10380011	GOIANIA LESTE S2	08/12/2020 17:47	08/12/2020 19:21	08/12/2020 17:47	08/12/2020 17:53	0,10	1639	163,90	CHI
20201242206	GOIANIA	GN16420125	GOIANIA LESTE S2	08/12/2020 17:47	08/12/2020 19:21	08/12/2020 17:47	08/12/2020 17:53	0,10	970	97,00	CHI
20201242206	BONFINOPOLIS	GN10380011	GOIANIA LESTE S2	08/12/2020 17:47	08/12/2020 19:21	08/12/2020 17:47	08/12/2020 17:53	0,10	90	9,00	CHI
20201242206	GOIANIA	GN10380011	GOIANIA LESTE S2	08/12/2020 17:47	08/12/2020 19:21	08/12/2020 17:47	08/12/2020 17:53	0,10	854	85,40	CHI
20201242206	GOIANAPOLIS	GN10380011	GOIANIA LESTE S2	08/12/2020 17:47	08/12/2020 19:21	08/12/2020 17:47	08/12/2020 17:53	0,10	30	3,00	CHI
20201242206	GOIANIA	GN16416162	GOIANIA LESTE S2	08/12/2020 17:47	08/12/2020 19:21	08/12/2020 17:47	08/12/2020 18:55	1,15	459	527,34	CHI
20201242206	GOIANIA	GN13030545	GOIANIA LESTE S2	08/12/2020 17:47	08/12/2020 19:21	08/12/2020 19:11	08/12/2020 19:21	0,17	325	56,60	CHI
20201242299	GOIANIA	GN11001907	GOIANIA LESTE S2	08/12/2020 17:47	08/12/2020 19:41	08/12/2020 17:47	08/12/2020 19:41	1,88	265	499,23	CHI
20201242062	CRIXAS	CX12252954	RUBIATABA	08/12/2020 17:48	10/12/2020 13:09	08/12/2020 17:48	09/12/2020 16:11	22,39	2	44,77	CHI
20201242062	CRIXAS	CX12252954	RUBIATABA	08/12/2020 17:48	10/12/2020 13:09	08/12/2020 17:48	10/12/2020 13:09	43,35	3	130,06	CHI
20201242283	FORMOSA	FA12041996	ITUIQUIRA	08/12/2020 17:49	08/12/2020 19:36	08/12/2020 17:49	08/12/2020 19:36	1,78	413	734,68	CHI
20201242093	BELA VISTA DE GOIAS	BV12360000	BELA VISTA S2	08/12/2020 17:50	09/12/2020 03:44	08/12/2020 17:50	09/12/2020 03:44	9,89	2	19,78	CHI
20201244209	LUZIANIA	LZ12396830	MARAJOARA	08/12/2020 17:50	09/12/2020 01:16	08/12/2020 17:50	09/12/2020 01:16	7,42	56	415,66	CHI
20201242105	MAIRIPOTABA	MI21078674	PONTALINA	08/12/2020 17:51	08/12/2020 22:28	08/12/2020 17:51	08/12/2020 22:28	4,61	2	9,23	CHI
20201242111	RIO VERDE	RV21098469	RIO VERDE S1	08/12/2020 17:51	08/12/2020 20:42	08/12/2020 17:51	08/12/2020 20:42	2,84	1	2,84	CHI
20201242403	CRISTALINA	KR10406854	CRISTALINA S2	08/12/2020 17:51	08/12/2020 22:57	08/12/2020 17:51	08/12/2020 19:49	1,96	77	151,01	CHI
20201242403	CRISTALINA	KR10406854	CRISTALINA S2	08/12/2020 17:51	08/12/2020 22:57	08/12/2020 17:51	08/12/2020 22:34	4,71	153	720,50	CHI
20201242403	CRISTALINA	KR10406854	CRISTALINA S2	08/12/2020 17:51	08/12/2020 22:57	08/12/2020 17:51	08/12/2020 22:57	5,09	95	483,79	CHI
20201242129	CAMPINACU	UC11269840	MARA ROSA	08/12/2020 17:52	09/12/2020 10:48	08/12/2020 17:52	09/12/2020 10:48	16,93	1	16,93	CHI
20201242826	PIRENOPOLIS	PV12295641	SAO FRANCISCO DE GOIAS	08/12/2020 17:52	08/12/2020 21:29	08/12/2020 17:52	08/12/2020 21:29	3,60	184	663,01	CHI
20201242152	PETROLINA DE GOIAS	SR21039132	INHUMAS S1	08/12/2020 17:53	09/12/2020 13:25	08/12/2020 17:53	09/12/2020 13:25	19,52	1	19,52	CHI
20201244622	GOIAS	GS12220498	GOIAS	08/12/2020 17:53	09/12/2020 03:21	08/12/2020 17:53	09/12/2020 03:21	9,47	46	435,42	CHI
20201242169	GOIANIA	17342971	GOYA S1	08/12/2020 17:54	09/12/2020 11:35	08/12/2020 17:54	09/12/2020 11:35	17,67	1	17,67	CHI
20201242662	BALIZA	BH12380942	BOM JARDIM	08/12/2020 17:54	08/12/2020 22:25	08/12/2020 17:54	08/12/2020 22:25	4,53	7	31,70	CHI
20201242202	FORMOSA	FA12383329LD	ITUIQUIRA	08/12/2020 17:55	09/12/2020 09:59	08/12/2020 17:55	09/12/2020 09:59	16,05	24	385,27	CHI
20201242589	CIDADE OCIDENTAL	DH11128792	MARAJOARA	08/12/2020 17:55	08/12/2020 20:51	08/12/2020 17:55	08/12/2020 20:51	2,92	121	353,49	CHI
20201243003	CORUMBA DE GOIAS	AX12000153	CORUMBA	08/12/2020 17:55	09/12/2020 14:13	08/12/2020 17:55	09/12/2020 14:13	20,29	10	202,94	CHI
20201242200	LUZIANIA	KR21041433	PAMPLONA	08/12/2020 17:56	09/12/2020 00:54	08/12/2020 17:56	09/12/2020 00:54	6,96	1	6,96	CHI
20201242838	CAMPESTRE DE GOIAS	GC12005198	TRINDADE	08/12/2020 17:57	09/12/2020 11:11	08/12/2020 17:57	09/12/2020 11:11	17,23	13	223,96	CHI
20201242219	RIO QUENTE	RQ21000045	RIO QUENTE	08/12/2020 17:58	08/12/2020 22:25	08/12/2020 17:58	08/12/2020 22:25	4,44	2	8,87	CHI
20201242228	CRISTALINA	10030580437	PAMPLONA	08/12/2020 17:59	08/12/2020 19:30	08/12/2020 17:59	08/12/2020 19:30	1,51	1	1,51	CHI
20201242346	ARAGUAPAZ	AZ12404563	GOIAS	08/12/2020 17:59	09/12/2020 08:51	08/12/2020 17:59	09/12/2020 08:51	14,86	20	297,11	CHI
20201242346	FAINA	AZ12404563	GOIAS	08/12/2020 17:59	09/12/2020 08:51	08/12/2020 17:59	09/12/2020 08:51	14,86	1	14,86	CHI
20201242762	NOVO BRASIL	NB12047598	JUSSARA	08/12/2020 17:59	09/12/2020 15:55	08/12/2020 17:59	09/12/2020 15:55	21,92	13	284,92	CHI
20201242800	PARANAIGUARA	PC12000129	CACHOEIRA ALTA	08/12/2020 17:59	08/12/2020 21:30	08/12/2020 17:59	08/12/2020 21:30	3,52	24	84,45	CHI
20201243170	NOVO BRASIL	NB11076351	JUSSARA	08/12/2020 17:59	08/12/2020 21:05	08/12/2020 17:59	08/12/2020 21:05	3,11	181	562,41	CHI

20201242524	URUANA	HE10400390	ITAPURANGA	08/12/2020 18:00	08/12/2020 18:13	08/12/2020 18:00	08/12/2020 18:04	0,05	1	0,05	CHI
20201242524	HEITORAI	HE10400390	ITAPURANGA	08/12/2020 18:00	08/12/2020 18:13	08/12/2020 18:00	08/12/2020 18:04	0,05	1461	79,14	CHI
20201242524	ITAGUARU	HE10400390	ITAPURANGA	08/12/2020 18:00	08/12/2020 18:13	08/12/2020 18:00	08/12/2020 18:04	0,05	56	3,03	CHI
20201242524	ITAPURANGA	HE10400390	ITAPURANGA	08/12/2020 18:00	08/12/2020 18:13	08/12/2020 18:00	08/12/2020 18:04	0,05	76	4,12	CHI
20201242524	GOIAS	HE10400390	ITAPURANGA	08/12/2020 18:00	08/12/2020 18:13	08/12/2020 18:00	08/12/2020 18:07	0,11	10	1,12	CHI
20201242524	ITAPURANGA	HE10400390	ITAPURANGA	08/12/2020 18:00	08/12/2020 18:13	08/12/2020 18:00	08/12/2020 18:07	0,11	85	9,49	CHI
20201242524	HEITORAI	HE10400390	ITAPURANGA	08/12/2020 18:00	08/12/2020 18:13	08/12/2020 18:00	08/12/2020 18:07	0,11	120	13,40	CHI
20201242524	GOIAS	HE10400390	ITAPURANGA	08/12/2020 18:00	08/12/2020 18:13	08/12/2020 18:00	08/12/2020 18:11	0,18	66	12,12	CHI
20201242524	HEITORAI	HE10400390	ITAPURANGA	08/12/2020 18:00	08/12/2020 18:13	08/12/2020 18:00	08/12/2020 18:11	0,18	46	8,45	CHI
20201242524	HEITORAI	HE10400390	ITABERAI S1	08/12/2020 18:00	08/12/2020 18:13	08/12/2020 18:00	08/12/2020 18:13	0,22	26	5,60	CHI
20201242524	GOIAS	HE10400390	ITABERAI S1	08/12/2020 18:00	08/12/2020 18:13	08/12/2020 18:00	08/12/2020 18:13	0,22	40	8,61	CHI
20201242524	ITABERAI	HE10400390	ITABERAI S1	08/12/2020 18:00	08/12/2020 18:13	08/12/2020 18:00	08/12/2020 18:13	0,22	74	15,93	CHI
20201242524	ITABERAI	HE16427006	ITABERAI S1	08/12/2020 18:00	08/12/2020 18:13	08/12/2020 18:05	08/12/2020 18:13	0,14	1	0,14	CHI
20201242545	ANAPOLIS	AN11121605	DAIA S1	08/12/2020 18:00	08/12/2020 23:50	08/12/2020 18:00	08/12/2020 23:50	5,82	149	867,06	CHI
20201242850	NOVA AMERICA	NM11047534	RUBIATABA	08/12/2020 18:00	09/12/2020 21:08	08/12/2020 18:00	09/12/2020 21:08	27,13	69	1871,78	CHI
20201242259	IPAMERI	IP12013258	IPAMERI	08/12/2020 18:01	08/12/2020 21:11	08/12/2020 18:01	08/12/2020 21:11	3,16	6	18,95	CHI
20201243142	FAZENDA NOVA	FN12076130	JUSSARA	08/12/2020 18:01	09/12/2020 09:50	08/12/2020 18:01	09/12/2020 09:50	15,81	93	1470,77	CHI
20201242269	LUZIANIA	LZ12000232	RIO VERMELHO	08/12/2020 18:02	08/12/2020 21:59	08/12/2020 18:02	08/12/2020 21:59	3,95	85	335,40	CHI
20201242282	CABECEIRAS	CW21108840	ITUIQUIRA	08/12/2020 18:02	09/12/2020 09:55	08/12/2020 18:02	09/12/2020 09:55	15,87	1	15,87	CHI
20201242755	NOVO BRASIL	NB11020195	JUSSARA	08/12/2020 18:02	09/12/2020 16:42	08/12/2020 18:02	09/12/2020 16:42	22,65	128	2899,63	CHI
20201243133	JATAI	JT12378171	MONTIVIDIU T	08/12/2020 18:02	09/12/2020 12:47	08/12/2020 18:02	09/12/2020 12:47	18,74	4	74,94	CHI
20201242286	GOIANIA	GN21127119	GOIANIA LESTE S3	08/12/2020 18:03	09/12/2020 02:18	08/12/2020 18:03	09/12/2020 02:18	8,25	1	8,25	CHI
20201242289	RIO VERDE	CP12191909	MONTIVIDIU T	08/12/2020 18:03	09/12/2020 21:33	08/12/2020 18:03	09/12/2020 21:33	27,50	3	82,50	CHI
20201242291	APARECIDA DE GOIANIA	200358297	INDEPENDENCIA S2	08/12/2020 18:03	08/12/2020 21:13	08/12/2020 18:03	08/12/2020 21:13	3,16	1	3,16	CHI
20201242294	COCALZINHO DE GOIAS	ZN12327452	GOIANESIA S1	08/12/2020 18:03	09/12/2020 15:10	08/12/2020 18:03	09/12/2020 14:00	19,94	5	99,71	CHI
20201242294	COCALZINHO DE GOIAS	ZN12327452	GOIANESIA S1	08/12/2020 18:03	09/12/2020 15:10	08/12/2020 18:03	09/12/2020 15:10	21,11	5	105,55	CHI
20201242663	LUZIANIA	LZ12016676	RIO VERMELHO	08/12/2020 18:04	08/12/2020 19:46	08/12/2020 18:04	08/12/2020 19:46	1,70	27	45,80	CHI
20201242393	IPAMERI	CM12127511	CAMPO ALEGRE DE GOIAS	08/12/2020 18:05	08/12/2020 19:25	08/12/2020 18:05	08/12/2020 19:25	1,32	3	3,96	CHI
20201242393	CAMPO ALEGRE DE GOIAS	CM12127511	CAMPO ALEGRE DE GOIAS	08/12/2020 18:05	08/12/2020 19:25	08/12/2020 18:05	08/12/2020 19:25	1,32	7	9,24	CHI
20201242334	PIRENOPOLIS	PV21123794	CORUMBA	08/12/2020 18:06	09/12/2020 16:20	08/12/2020 18:06	09/12/2020 16:20	22,24	1	22,24	CHI
20201242335	CRISTALINA	10012722390	PAMPLONA	08/12/2020 18:06	08/12/2020 20:15	08/12/2020 18:06	08/12/2020 20:15	2,15	1	2,15	CHI
20201242337	BURITI ALEGRE	BG12249831	ITUMBIARA VELHA S2	08/12/2020 18:06	09/12/2020 14:04	08/12/2020 18:06	09/12/2020 14:04	19,96	2	39,93	CHI
20201242340	JATAI	JT21348498	JATAI S1	08/12/2020 18:06	08/12/2020 22:33	08/12/2020 18:06	08/12/2020 22:33	4,44	1	4,44	CHI
20201242352	RIO VERDE	RV13380665	RIO VERDE S1	08/12/2020 18:07	08/12/2020 21:47	08/12/2020 18:07	08/12/2020 21:47	3,67	923	3391,77	CHI
20201242354	FAINA	FC21158819	GOIAS	08/12/2020 18:07	09/12/2020 12:54	08/12/2020 18:07	09/12/2020 12:54	18,78	2	37,55	CHI
20201242356	MONTES CLAROS DE GOIAS	ME21138678	IPORA	08/12/2020 18:07	09/12/2020 12:12	08/12/2020 18:07	09/12/2020 12:12	18,07	1	18,07	CHI
20201242519	TEREZOPOLIS DE GOIAS	GP12382871	JUNDIAI S2	08/12/2020 18:07	09/12/2020 04:39	08/12/2020 18:07	09/12/2020 04:39	10,53	1	10,53	CHI
20201242519	ANAPOLIS	GP12382871	JUNDIAI S2	08/12/2020 18:07	09/12/2020 04:39	08/12/2020 18:07	09/12/2020 04:39	10,53	5	52,63	CHI
20201243276	PARAUNA	PU12034828	ACREUNA	08/12/2020 18:07	09/12/2020 09:45	08/12/2020 18:07	09/12/2020 09:45	15,62	14	218,67	CHI
20201242379	CABECEIRAS	CW11042594	ITUIQUIRA	08/12/2020 18:08	09/12/2020 07:50	08/12/2020 18:08	09/12/2020 07:50	13,69	143	1957,11	CHI
20201242419	OUVIDOR	OU10401443	CATALAO S1	08/12/2020 18:08	09/12/2020 17:36	08/12/2020 18:08	08/12/2020 21:15	3,12	10	31,21	CHI
20201242419	OUVIDOR	OU10401443	CATALAO S1	08/12/2020 18:08	09/12/2020 17:36	08/12/2020 18:08	09/12/2020 17:36	23,46	4	93,85	CHI
20201242386	ITAPURANGA	IK21023088	ITAPURANGA	08/12/2020 18:09	09/12/2020 10:06	08/12/2020 18:09	09/12/2020 10:06	15,95	1	15,95	CHI
20201242389	MORRINHOS	MR21000112	MORRINHOS	08/12/2020 18:09	09/12/2020 03:23	08/12/2020 18:09	09/12/2020 03:23	9,23	1	9,23	CHI
20201242443	OURO VERDE DE GOIAS	OV12215905	NEROPOLIS S2	08/12/2020 18:09	09/12/2020 11:49	08/12/2020 18:09	09/12/2020 11:49	17,67	10	176,66	CHI
20201242417	GOIANIA	11333911	GOIANIA LESTE S3	08/12/2020 18:10	08/12/2020 21:54	08/12/2020 18:10	08/12/2020 21:54	3,72	1	3,72	CHI
20201242422	MUNDO NOVO DE GOIAS	4240014671	NOVA CRIXAS	08/12/2020 18:10	08/12/2020 20:00	08/12/2020 18:10	08/12/2020 20:00	1,82	1	1,82	CHI
20201242435	PIRACANJUBA	BV21208851	BELA VISTA S1	08/12/2020 18:11	08/12/2020 21:36	08/12/2020 18:11	08/12/2020 21:36	3,41	2	6,82	CHI
20201243117	NOVO BRASIL	NB11220286	JUSSARA	08/12/2020 18:11	08/12/2020 20:45	08/12/2020 18:11	08/12/2020 20:45	2,58	67	172,62	CHI
20201242447	ITAUCU	IX21363358	INHUMAS S1	08/12/2020 18:12	08/12/2020 23:15	08/12/2020 18:12	08/12/2020 23:15	5,04	1	5,04	CHI
20201242882	ANAPOLIS	AN12000673	JUNDIAI S1	08/12/2020 18:12	08/12/2020 21:16	08/12/2020 18:12	08/12/2020 21:16	3,05	348	1061,98	CHI

20201243492	MONTES CLAROS DE GOIAS	ME12334760	IPORA	08/12/2020 18:12	09/12/2020 13:23	08/12/2020 18:12	09/12/2020 13:23	19,17	5	95,84	CHI
20201244190	SENADOR CANEDO	SW11054745	SENADOR CANEDO	08/12/2020 18:12	09/12/2020 00:30	08/12/2020 18:12	09/12/2020 00:30	6,30	134	843,64	CHI
20201242465	URUACU	UR21156458	CAMPINORTE	08/12/2020 18:13	08/12/2020 21:01	08/12/2020 18:13	08/12/2020 21:01	2,78	1	2,78	CHI
20201242668	PETROLINA DE GOIAS	PG12111252	PETROLINA	08/12/2020 18:13	10/12/2020 10:00	08/12/2020 18:13	10/12/2020 10:00	39,78	2	79,56	CHI
20201242824	PIRENOPOLIS	PV12008487	CORUMBA	08/12/2020 18:13	08/12/2020 23:53	08/12/2020 18:13	08/12/2020 23:53	5,67	76	430,65	CHI
20201243131	GAMELEIRA DE GOIAS	SV12093659	DAIA S2	08/12/2020 18:13	08/12/2020 20:14	08/12/2020 18:13	08/12/2020 20:14	2,01	18	36,27	CHI
20201243306	SERRANOPOLIS	SX12166103	JATAI S1	08/12/2020 18:13	09/12/2020 07:39	08/12/2020 18:13	09/12/2020 07:39	13,43	5	67,16	CHI
20201242486	PORANGATU	PO21172410	PORANGATU	08/12/2020 18:14	08/12/2020 20:24	08/12/2020 18:14	08/12/2020 20:24	2,15	1	2,15	CHI
20201242499	GOIATUBA	JV1200004RE	GOIATUBA S1	08/12/2020 18:14	08/12/2020 21:58	08/12/2020 18:14	08/12/2020 21:58	3,73	13	48,48	CHI
20201242499	JOVIANIA	JV1200004RE	GOIATUBA S1	08/12/2020 18:14	08/12/2020 21:58	08/12/2020 18:14	08/12/2020 21:58	3,73	23	85,78	CHI
20201242603	FAINA	FC12274422	GOIAS	08/12/2020 18:14	09/12/2020 08:38	08/12/2020 18:14	09/12/2020 08:38	14,39	58	834,60	CHI
20201242928	SANCLERLANDIA	SC11019292	FIRMINOPOLIS S2	08/12/2020 18:14	09/12/2020 01:16	08/12/2020 18:14	09/12/2020 01:16	7,02	165	1158,07	CHI
20201248042	SANTO ANTONIO DA BARRA	RV12301462	ACREUNA	08/12/2020 18:14	09/12/2020 11:29	08/12/2020 18:14	09/12/2020 11:29	17,24	1	17,24	CHI
20201248042	RIO VERDE	RV12301462	ACREUNA	08/12/2020 18:14	09/12/2020 11:29	08/12/2020 18:14	09/12/2020 11:29	17,24	4	68,95	CHI
20201242503	MINEIROS	MY11105585	PARQUE DAS EMAS	08/12/2020 18:15	08/12/2020 18:50	08/12/2020 18:15	08/12/2020 18:50	0,57	92	52,31	CHI
20201242504	JANDAIA	JD21100453	PALMEIRAS	08/12/2020 18:16	09/12/2020 04:44	08/12/2020 18:16	09/12/2020 04:44	10,46	2	20,93	CHI
20201242508	IPAMERI	IP21323369	CRISTALINA S1	08/12/2020 18:16	09/12/2020 00:07	08/12/2020 18:16	09/12/2020 00:07	5,84	1	5,84	CHI
20201243512	ITAPURANGA	GR12299466	ITAPURANGA	08/12/2020 18:16	08/12/2020 23:48	08/12/2020 18:16	08/12/2020 23:48	5,52	19	104,89	CHI
20201243512	GUARAITA	GK12299466	ITAPURANGA	08/12/2020 18:16	08/12/2020 23:48	08/12/2020 18:16	08/12/2020 23:48	5,52	29	160,10	CHI
20201243952	RUBIATABA	RB12197854	RUBIATABA	08/12/2020 18:16	08/12/2020 22:45	08/12/2020 18:16	08/12/2020 22:45	4,47	10	44,71	CHI
20201242523	SERRANOPOLIS	SX21037677	JATAI S1	08/12/2020 18:17	08/12/2020 21:54	08/12/2020 18:17	08/12/2020 21:54	3,61	1	3,61	CHI
20201242592	LUZIANIA	LZ12031093	RIO VERMELHO	08/12/2020 18:17	09/12/2020 02:40	08/12/2020 18:17	09/12/2020 02:40	8,37	41	343,25	CHI
20201242592	CIDADE OCIDENTAL	LZ12031093	RIO VERMELHO	08/12/2020 18:17	09/12/2020 02:40	08/12/2020 18:17	09/12/2020 02:40	8,37	9	75,35	CHI
20201242554	CROMINIA	CQ21193799	PONTALINA	08/12/2020 18:19	09/12/2020 13:20	08/12/2020 18:19	09/12/2020 13:20	19,01	1	19,01	CHI
20201242558	CATALAO	CT12373653	CATALAO S1	08/12/2020 18:19	08/12/2020 20:12	08/12/2020 18:19	08/12/2020 20:12	1,87	1	1,87	CHI
20201243103	GOIAS	GS12000010	GOIAS	08/12/2020 18:19	08/12/2020 22:20	08/12/2020 18:19	08/12/2020 22:20	4,02	762	3060,49	CHI
20201244379	RIO VERDE	RV12327049	CABRIUVA S2	08/12/2020 18:19	09/12/2020 17:41	08/12/2020 18:19	09/12/2020 17:41	23,36	3	70,09	CHI
20201242570	GOIANIA	GN21033399	SENADOR CANEDO	08/12/2020 18:20	08/12/2020 20:47	08/12/2020 18:20	08/12/2020 20:47	2,45	1	2,45	CHI
20201242577	QUIRINOPOLIS	QI21306112	QUIRINOPOLIS	08/12/2020 18:21	08/12/2020 20:32	08/12/2020 18:21	08/12/2020 20:32	2,18	1	2,18	CHI
20201242581	DAVINOPOLIS	IO12085161	CATALAO S1	08/12/2020 18:21	08/12/2020 20:00	08/12/2020 18:21	08/12/2020 20:00	1,64	2	3,29	CHI
20201242606	MONTIVIDU DO NORTE	MX21240684	PORANGATU	08/12/2020 18:23	08/12/2020 22:54	08/12/2020 18:23	08/12/2020 22:54	4,51	1	4,51	CHI
20201242857	GOIANIA	GN11078251	GOIANIA LESTE S2	08/12/2020 18:24	09/12/2020 12:19	08/12/2020 18:24	09/12/2020 12:19	17,90	29	519,18	CHI
20201243314	LUZIANIA	LZ12112942	PAMPLONA	08/12/2020 18:24	09/12/2020 00:06	08/12/2020 18:24	09/12/2020 00:06	5,69	9	51,24	CHI
20201242635	SENADOR CANEDO	SW11322857	SENADOR CANEDO	08/12/2020 18:25	08/12/2020 20:40	08/12/2020 18:25	08/12/2020 20:40	2,23	124	277,04	CHI
20201242642	NEROPOLIS	NR12391379	NEROPOLIS S2	08/12/2020 18:26	09/12/2020 16:49	08/12/2020 18:26	09/12/2020 16:49	22,38	6	134,26	CHI
20201242647	CRISTALINA	KR12133610	CRISTALINA S2	08/12/2020 18:26	09/12/2020 11:40	08/12/2020 18:26	09/12/2020 11:40	17,22	12	206,66	CHI
20201242652	GOIANIA	10107095	XAVANTES	08/12/2020 18:26	08/12/2020 21:05	08/12/2020 18:26	08/12/2020 21:05	2,63	1	2,63	CHI
20201242823	OURO VERDE DE GOIAS	OV12033148	NEROPOLIS S1	08/12/2020 18:26	09/12/2020 03:43	08/12/2020 18:26	09/12/2020 03:43	9,27	4	37,09	CHI
20201242823	CAMPO LIMPO	OV12033148	NEROPOLIS S1	08/12/2020 18:26	09/12/2020 03:43	08/12/2020 18:26	09/12/2020 03:43	9,27	3	27,81	CHI
20201243719	GOIAS	GK12299432	ITAPURANGA	08/12/2020 18:26	09/12/2020 10:19	08/12/2020 18:26	09/12/2020 10:19	15,88	11	174,69	CHI
20201243719	GUARAITA	GK12299432	ITAPURANGA	08/12/2020 18:26	09/12/2020 10:19	08/12/2020 18:26	09/12/2020 10:19	15,88	107	1699,22	CHI
20201249072	CORREGO DO OURO	CO12216963	FIRMINOPOLIS S2	08/12/2020 18:27	09/12/2020 18:10	08/12/2020 18:27	09/12/2020 18:10	23,71	7	165,94	CHI
20201242676	SANTA CRUZ DE GOIAS	PZ21064846	PIRES DO RIO S2	08/12/2020 18:28	09/12/2020 15:05	08/12/2020 18:28	09/12/2020 15:05	20,61	1	20,61	CHI
20201242679	PORTELANDIA	PW21318133	PARQUE DAS EMAS	08/12/2020 18:28	09/12/2020 09:22	08/12/2020 18:28	09/12/2020 09:22	14,89	1	14,89	CHI
20201242725	SAO LUIZ DO NORTE	10003140510	BARRO ALTO	08/12/2020 18:30	09/12/2020 08:48	08/12/2020 18:30	09/12/2020 08:48	14,29	1	14,29	CHI
20201242739	ISRAELANDIA	IS12139430	IPORA	08/12/2020 18:30	08/12/2020 22:47	08/12/2020 18:30	08/12/2020 22:47	4,28	20	85,55	CHI
20201242810	JUSSARA	JR12362437	BRITANIA	08/12/2020 18:30	09/12/2020 15:00	08/12/2020 18:30	09/12/2020 15:00	20,49	6	122,96	CHI
20201242810	FAZENDA NOVA	JR12362437	BRITANIA	08/12/2020 18:30	09/12/2020 15:00	08/12/2020 18:30	09/12/2020 15:00	20,49	3	61,48	CHI
20201243198	PALESTINA DE GOIAS	PY12187367	PALESTINA	08/12/2020 18:30	09/12/2020 08:57	08/12/2020 18:30	09/12/2020 08:57	14,44	3	43,33	CHI
20201243728	PILAR DE GOIAS	GG12243730	SANTA TEREZINHA	08/12/2020 18:30	08/12/2020 22:51	08/12/2020 18:30	08/12/2020 22:51	4,35	28	121,71	CHI
20201242728	URUTAI	600000904	URUTAI	08/12/2020 18:31	08/12/2020 19:38	08/12/2020 18:31	08/12/2020 19:38	1,12	1	1,12	CHI

20201243186	LUZIANIA	LZ12041476	RIO VERMELHO	08/12/2020 18:31	08/12/2020 22:01	08/12/2020 18:31	08/12/2020 22:01	3,49	23	80,31	CHI
20201242765	ALTO PARAISO DE GOIAS	BF12302869	SAO JOAO D ALIANCA	08/12/2020 18:33	09/12/2020 11:45	08/12/2020 18:33	09/12/2020 11:45	17,19	1	17,19	CHI
20201242774	DOVERLANDIA	DV11138412	CAIAPONIA	08/12/2020 18:33	09/12/2020 11:50	08/12/2020 18:33	09/12/2020 11:50	17,27	3	51,81	CHI
20201243079	MONTES CLAROS DE GOIAS	ME12066064	IPORA	08/12/2020 18:33	09/12/2020 05:31	08/12/2020 18:33	09/12/2020 05:31	10,96	24	263,00	CHI
20201243631	ORIZONA	OZ12359916	PIRES DO RIO S1	08/12/2020 18:33	08/12/2020 22:11	08/12/2020 18:33	08/12/2020 22:11	3,62	20	72,39	CHI
20201242778	GUAPO	710025889	GUAPO S1	08/12/2020 18:34	09/12/2020 04:45	08/12/2020 18:34	09/12/2020 04:45	10,18	1	10,18	CHI
20201243274	ANAPOLIS	AN13374436	ANAPOLIS UNIVERSITARIO S1	08/12/2020 18:34	09/12/2020 12:17	08/12/2020 18:34	09/12/2020 12:16	17,69	348	6157,67	CHI
20201243274	ABADIANIA	AN10404065	ANAPOLIS UNIVERSITARIO S1	08/12/2020 18:34	09/12/2020 12:17	08/12/2020 18:34	09/12/2020 12:17	17,71	70	1239,56	CHI
20201243274	ANAPOLIS	AN10404065	ANAPOLIS UNIVERSITARIO S1	08/12/2020 18:34	09/12/2020 12:17	08/12/2020 18:34	09/12/2020 12:17	17,71	85	1505,18	CHI
20201242805	VALPARAISO DE GOIAS	VA11206745	PACAEMBU S2	08/12/2020 18:35	08/12/2020 21:16	08/12/2020 18:35	08/12/2020 21:16	2,67	18	48,11	CHI
20201243447	OURO VERDE DE GOIAS	OV12115017	NEROPOLIS S1	08/12/2020 18:35	09/12/2020 03:11	08/12/2020 18:35	09/12/2020 03:11	8,60	9	77,39	CHI
20201243835	LUZIANIA	LZ13401757	RIO VERMELHO	08/12/2020 18:35	09/12/2020 02:26	08/12/2020 18:35	09/12/2020 02:26	7,86	669	5259,08	CHI
20201243835	LUZIANIA	LZ13401757	RIO VERMELHO	08/12/2020 18:35	09/12/2020 02:26	09/12/2020 00:46	09/12/2020 02:26	1,68	846	1417,29	CHI
20201243888	TRINDADE	TR12015734	INHUMAS S1	08/12/2020 18:35	09/12/2020 01:15	08/12/2020 18:35	09/12/2020 01:15	6,66	2	13,31	CHI
20201243888	GOIANIRA	TR12015734	INHUMAS S1	08/12/2020 18:35	09/12/2020 01:15	08/12/2020 18:35	09/12/2020 01:15	6,66	16	106,52	CHI
20201243290	ANAPOLIS	AN12096740	JUNDIAI S2	08/12/2020 18:36	08/12/2020 23:09	08/12/2020 18:36	08/12/2020 23:09	4,55	21	95,51	CHI
20201243450	COLINAS DO SUL	TI12355513	NIQUELANDIA SUBTRANSMISSAO	08/12/2020 18:37	09/12/2020 00:15	08/12/2020 18:37	09/12/2020 00:15	5,63	12	67,58	CHI
20201242840	RIO VERDE	10002229879	RIO VERDE S1	08/12/2020 18:38	08/12/2020 22:42	08/12/2020 18:38	08/12/2020 22:42	4,06	1	4,06	CHI
20201242848	LUZIANIA	LZ12370853	MARAJOARA	08/12/2020 18:38	09/12/2020 14:46	08/12/2020 18:38	09/12/2020 14:46	20,13	12	241,58	CHI
20201244243	CAIAPONIA	CP12395452	PALESTINA	08/12/2020 18:38	09/12/2020 13:29	08/12/2020 18:38	09/12/2020 13:29	18,85	73	1375,71	CHI
20201243109	PALMEIRAS DE GOIAS	PL12289855	ANICUNS	08/12/2020 18:39	09/12/2020 10:39	08/12/2020 18:39	09/12/2020 10:39	16,00	23	368,01	CHI
20201243119	CATALAO	CT12215606RE	CATALAO S1	08/12/2020 18:39	08/12/2020 21:22	08/12/2020 18:39	08/12/2020 21:22	2,70	19	51,37	CHI
20201243119	GOIANDIRA	CT12215606RE	CATALAO S1	08/12/2020 18:39	08/12/2020 21:22	08/12/2020 18:39	08/12/2020 21:22	2,70	17	45,97	CHI
20201242911	SANCLERLANDIA	SC12388895	FIRMINOPOLIS S2	08/12/2020 18:41	09/12/2020 06:36	08/12/2020 18:41	09/12/2020 06:36	11,90	3	35,70	CHI
20201243651	GOIANIA	GN12051055	CAMPINAS S2	08/12/2020 18:41	08/12/2020 21:01	08/12/2020 18:41	08/12/2020 21:01	2,33	93	216,41	CHI
20201242899	CALDAS NOVAS	CN11204428	SERRA DE CALDAS	08/12/2020 18:42	09/12/2020 13:03	08/12/2020 18:42	09/12/2020 13:03	18,34	1	18,34	CHI
20201242903	COLINAS DO SUL	TI12256389	NIQUELANDIA SUBTRANSMISSAO	08/12/2020 18:42	09/12/2020 09:07	08/12/2020 18:42	09/12/2020 09:07	14,40	1	14,40	CHI
20201242903	NIQUELANDIA	TI12256389	NIQUELANDIA SUBTRANSMISSAO	08/12/2020 18:42	09/12/2020 09:07	08/12/2020 18:42	09/12/2020 09:07	14,40	4	57,62	CHI
20201248043	RIO VERDE	BZ12255714	ACREUNA	08/12/2020 18:42	09/12/2020 13:17	08/12/2020 18:42	09/12/2020 13:17	18,57	6	111,44	CHI
20201248043	SANTO ANTONIO DA BARRA	BZ12255714	ACREUNA	08/12/2020 18:42	09/12/2020 13:17	08/12/2020 18:42	09/12/2020 13:17	18,57	5	92,86	CHI
20201242925	ALTO PARAISO DE GOIAS	BF12344268	FLORES DE GOIAS	08/12/2020 18:43	09/12/2020 07:49	08/12/2020 18:43	09/12/2020 07:49	13,09	2	26,17	CHI
20201243501	BURITI DE GOIAS	BS11045643	FIRMINOPOLIS S2	08/12/2020 18:43	09/12/2020 02:51	08/12/2020 18:43	09/12/2020 02:51	8,12	105	852,83	CHI
20201242932	TURVANIA	TV12289727	FIRMINOPOLIS S2	08/12/2020 18:44	09/12/2020 18:28	08/12/2020 18:44	09/12/2020 18:28	23,73	3	71,19	CHI
20201242933	IPORA	IR21138601	IPORA	08/12/2020 18:44	09/12/2020 09:40	08/12/2020 18:44	09/12/2020 09:40	14,93	1	14,93	CHI
20201242950	DIORAMA	DI21246143	IPORA	08/12/2020 18:45	09/12/2020 13:21	08/12/2020 18:45	09/12/2020 13:21	18,59	1	18,59	CHI
20201242955	MORRINHOS	MR21000279	MORRINHOS	08/12/2020 18:45	09/12/2020 07:04	08/12/2020 18:45	09/12/2020 07:04	12,30	1	12,30	CHI
20201242961	MINACU	4020052683	MINACU	08/12/2020 18:46	09/12/2020 09:29	08/12/2020 18:46	09/12/2020 09:29	14,71	1	14,71	CHI
20201242966	MINEIROS	MY21361746	PARQUE DAS EMAS	08/12/2020 18:46	09/12/2020 04:13	08/12/2020 18:46	09/12/2020 04:13	9,44	1	9,44	CHI
20201242971	BELA VISTA DE GOIAS	BV21324960	BELA VISTA S2	08/12/2020 18:46	08/12/2020 22:13	08/12/2020 18:46	08/12/2020 22:13	3,44	2	6,88	CHI
20201242972	LUZIANIA	LZ12351401RE	MARAJOARA	08/12/2020 18:46	10/12/2020 14:40	08/12/2020 18:46	10/12/2020 13:49	43,04	26	1119,10	CHI
20201242972	LUZIANIA	LZ12351401RE	MARAJOARA	08/12/2020 18:46	10/12/2020 14:40	09/12/2020 00:49	10/12/2020 13:49	37,00	2	74,01	CHI
20201242972	LUZIANIA	LZ12351401RE	MARAJOARA	08/12/2020 18:46	10/12/2020 14:40	08/12/2020 18:46	10/12/2020 14:23	43,61	1	43,61	CHI
20201242972	LUZIANIA	LZ12351401RE	MARAJOARA	08/12/2020 18:46	10/12/2020 14:40	08/12/2020 18:46	10/12/2020 14:40	43,89	3	131,67	CHI
20201243210	AURILANDIA	CG12382596	FIRMINOPOLIS S2	08/12/2020 18:46	08/12/2020 22:16	08/12/2020 18:46	08/12/2020 22:16	3,49	24	83,75	CHI
20201243210	MOIPORA	CG12382596	FIRMINOPOLIS S2	08/12/2020 18:46	08/12/2020 22:16	08/12/2020 18:46	08/12/2020 22:16	3,49	1	3,49	CHI
20201243210	CACHEIRA DE GOIAS	CG12382596	FIRMINOPOLIS S2	08/12/2020 18:46	08/12/2020 22:16	08/12/2020 18:46	08/12/2020 22:16	3,49	2	6,98	CHI
20201242981	PIRES DO RIO	PR12186659	PIRES DO RIO S1	08/12/2020 18:47	08/12/2020 19:23	08/12/2020 18:47	08/12/2020 19:23	0,59	116	67,99	CHI
20201242985	URUTAI	UT21016956	URUTAI	08/12/2020 18:48	08/12/2020 20:57	08/12/2020 18:48	08/12/2020 20:57	2,15	1	2,15	CHI
20201242986	JAUPACI	JP21229150	IPORA	08/12/2020 18:48	08/12/2020 20:15	08/12/2020 18:48	08/12/2020 20:15	1,45	1	1,45	CHI
20201242989	RIO VERDE	630092424	RIO VERDE S2	08/12/2020 18:48	08/12/2020 22:08	08/12/2020 18:48	08/12/2020 22:08	3,33	1	3,33	CHI
20201242997	ALEXANIA	AX12295588	ALEXANIA	08/12/2020 18:48	09/12/2020 12:46	08/12/2020 18:48	09/12/2020 12:46	17,96	8	143,65	CHI

20201243002	MONTIVIDIU	MV21030651	MONTIVIDIU T	08/12/2020 18:48	08/12/2020 23:33	08/12/2020 18:48	08/12/2020 23:33	4,73	1	4,73	CHI
20201243717	IPAMERI	IP12031355	IPAMERI	08/12/2020 18:48	08/12/2020 23:51	08/12/2020 18:48	08/12/2020 23:51	5,04	12	60,53	CHI
20201244373	SANTO ANTONIO DO DESCOBERTO	SN11151460	ALEXANIA	08/12/2020 18:48	08/12/2020 23:51	08/12/2020 18:48	08/12/2020 23:51	5,04	182	917,38	CHI
20201243008	FORMOSO	FO21071163	PORANGATU	08/12/2020 18:49	09/12/2020 02:43	08/12/2020 18:49	09/12/2020 02:43	7,89	1	7,89	CHI
20201243010	PIRENOPOLIS	220036706	CORUMBA	08/12/2020 18:49	09/12/2020 03:51	08/12/2020 18:49	09/12/2020 03:51	9,03	1	9,03	CHI
20201243016	JUSSARA	JR12090772	BRITANIA	08/12/2020 18:49	09/12/2020 14:58	08/12/2020 18:49	09/12/2020 14:58	20,14	4	80,55	CHI
20201243623	ANAPOLIS	AN12201240	ANAPOLIS UNIVERSITARIO S2	08/12/2020 18:50	09/12/2020 06:51	08/12/2020 18:50	09/12/2020 06:51	12,01	9	108,11	CHI
20201243054	GOIANESIA	550205676	GOIANESIA S2	08/12/2020 18:51	09/12/2020 03:25	08/12/2020 18:51	09/12/2020 03:25	8,56	1	8,56	CHI
20201243062	SENADOR CANEDO	SW21032482	SENADOR CANEDO	08/12/2020 18:51	08/12/2020 20:43	08/12/2020 18:51	08/12/2020 20:43	1,85	1	1,85	CHI
20201243661	MOZARLANDIA	AZ12216257	MOZARLANDIA	08/12/2020 18:51	09/12/2020 11:40	08/12/2020 18:51	09/12/2020 11:40	16,81	1	16,81	CHI
20201243661	ARAGUAPAZ	AZ12216257	MOZARLANDIA	08/12/2020 18:51	09/12/2020 11:40	08/12/2020 18:51	09/12/2020 11:40	16,81	7	117,69	CHI
20201243171	SERRANOPOLIS	SX12072421	JATAI S1	08/12/2020 18:53	09/12/2020 09:04	08/12/2020 18:53	09/12/2020 09:04	14,18	5	70,88	CHI
20201243594	SILVANIA	SV12087254	DAIA S2	08/12/2020 18:53	08/12/2020 22:10	08/12/2020 18:53	08/12/2020 22:10	3,28	12	39,31	CHI
20201243101	ACREUNA	2440068609	ACREUNA	08/12/2020 18:54	08/12/2020 20:52	08/12/2020 18:54	08/12/2020 20:52	1,95	1	1,95	CHI
20201243106	JATAI	JT12105211	JATAI S1	08/12/2020 18:54	08/12/2020 22:41	08/12/2020 18:54	08/12/2020 22:41	3,78	25	94,53	CHI
20201243105	LUZIANIA	LZ13414286	RIO VERMELHO	08/12/2020 18:55	08/12/2020 23:56	08/12/2020 21:59	08/12/2020 23:56	1,95	3	5,85	CHI
20201243108	GOIANIA	11008568	FERROVIARIO S2	08/12/2020 18:55	09/12/2020 01:04	08/12/2020 18:55	09/12/2020 01:04	6,14	1	6,14	CHI
20201243116	MORRINHOS	MR21102222	MORRINHOS	08/12/2020 18:55	09/12/2020 01:33	08/12/2020 18:55	09/12/2020 01:33	6,62	1	6,62	CHI
20201243124	MORRO AGUDO DE GOIAS	MS21185016	ITAPURANGA	08/12/2020 18:56	09/12/2020 15:43	08/12/2020 18:56	09/12/2020 15:43	20,78	1	20,78	CHI
20201243136	CAMPO ALEGRE DE GOIAS	CM12376048	CAMPO ALEGRE DE GOIAS	08/12/2020 18:57	12/12/2020 13:40	08/12/2020 18:57	09/12/2020 17:24	22,45	7	157,17	CHI
20201243136	CATALAO	CM12376048	CAMPO ALEGRE DE GOIAS	08/12/2020 18:57	12/12/2020 13:40	08/12/2020 18:57	09/12/2020 17:24	22,45	12	269,44	CHI
20201243136	CAMPO ALEGRE DE GOIAS	CM12376048	CAMPO ALEGRE DE GOIAS	08/12/2020 18:57	12/12/2020 13:40	08/12/2020 18:57	10/12/2020 13:25	42,46	6	254,77	CHI
20201243136	DISTRITO FEDERAL	CM12376048	CAMPO ALEGRE DE GOIAS	08/12/2020 18:57	12/12/2020 13:40	08/12/2020 18:57	10/12/2020 13:25	42,46	1	42,46	CHI
20201243136	CAMPO ALEGRE DE GOIAS	CM12376048	CAMPO ALEGRE DE GOIAS	08/12/2020 18:57	12/12/2020 13:40	10/12/2020 11:52	10/12/2020 13:25	1,55	7	10,82	CHI
20201243136	CATALAO	CM12376048	CAMPO ALEGRE DE GOIAS	08/12/2020 18:57	12/12/2020 13:40	10/12/2020 11:52	10/12/2020 13:25	1,55	12	18,54	CHI
20201243136	CATALAO	CM12376048	CAMPO ALEGRE DE GOIAS	08/12/2020 18:57	12/12/2020 13:40	10/12/2020 14:27	10/12/2020 20:40	6,21	12	74,50	CHI
20201243136	CAMPO ALEGRE DE GOIAS	CM12376048	CAMPO ALEGRE DE GOIAS	08/12/2020 18:57	12/12/2020 13:40	10/12/2020 14:27	10/12/2020 20:40	6,21	13	80,71	CHI
20201243136	DISTRITO FEDERAL	CM12376048	CAMPO ALEGRE DE GOIAS	08/12/2020 18:57	12/12/2020 13:40	10/12/2020 14:27	10/12/2020 20:40	6,21	1	6,21	CHI
20201243136	CAMPO ALEGRE DE GOIAS	CM12286874	CAMPO ALEGRE DE GOIAS	08/12/2020 18:57	12/12/2020 13:40	08/12/2020 18:57	12/12/2020 13:40	90,72	1	90,72	CHI
20201243136	CATALAO	CM12286874	CAMPO ALEGRE DE GOIAS	08/12/2020 18:57	12/12/2020 13:40	08/12/2020 18:57	12/12/2020 13:40	90,72	2	181,44	CHI
20201243305	ITABERAI	IB12250751	ITABERAI S1	08/12/2020 18:57	09/12/2020 18:35	08/12/2020 18:57	09/12/2020 14:38	19,68	3	59,05	CHI
20201243305	ITABERAI	IB12250751	ITABERAI S1	08/12/2020 18:57	09/12/2020 18:35	08/12/2020 18:57	09/12/2020 18:35	23,64	4	94,55	CHI
20201243305	ITABERAI	IB12253438LD	ITABERAI S1	08/12/2020 18:57	09/12/2020 18:35	08/12/2020 23:08	09/12/2020 18:35	19,45	1	19,45	CHI
20201243417	ITAGUARU	IC11154617	ITABERAI S1	08/12/2020 18:57	09/12/2020 12:35	08/12/2020 18:57	09/12/2020 12:35	17,62	158	2784,27	CHI
20201243366	MOSSAMEDES	IB12304486	ANICUNS	08/12/2020 18:58	09/12/2020 01:24	08/12/2020 18:58	09/12/2020 01:24	6,43	5	32,14	CHI
20201243366	ITABERAI	IB12304486	ANICUNS	08/12/2020 18:58	09/12/2020 01:24	08/12/2020 18:58	09/12/2020 01:24	6,43	59	379,29	CHI
20201243156	CRISTALINA	3490006791	PAMPLONA	08/12/2020 18:59	08/12/2020 21:48	08/12/2020 18:59	08/12/2020 21:48	2,81	1	2,81	CHI
2020120800104	TAQUARAL DE GOIAS	35501	ITABERAI S1	08/12/2020 18:59	08/12/2020 19:03	08/12/2020 18:59	08/12/2020 19:03	0,07	1749	116,60	CHI
2020120800104	ITABERAI	17901	ITABERAI S1	08/12/2020 18:59	08/12/2020 19:03	08/12/2020 18:59	08/12/2020 19:03	0,07	148	9,87	CHI
2020120800104	GOIAS	00880414	ITABERAI S1	08/12/2020 18:59	08/12/2020 19:03	08/12/2020 18:59	08/12/2020 19:03	0,07	136	9,07	CHI
2020120800104	GOIAS	00880424	ITABERAI S1	08/12/2020 18:59	08/12/2020 19:03	08/12/2020 18:59	08/12/2020 19:03	0,07	39	2,60	CHI
2020120800104	ITABERAI	00880424	ITABERAI S1	08/12/2020 18:59	08/12/2020 19:03	08/12/2020 18:59	08/12/2020 19:03	0,07	548	36,53	CHI
2020120800104	ITABERAI	00880414	ITABERAI S1	08/12/2020 18:59	08/12/2020 19:03	08/12/2020 18:59	08/12/2020 19:03	0,07	99	6,60	CHI
2020120800104	MOSSAMEDES	00880414	ITABERAI S1	08/12/2020 18:59	08/12/2020 19:03	08/12/2020 18:59	08/12/2020 19:03	0,07	209	13,93	CHI
2020120800104	ITABERAI	00880404	ITABERAI S1	08/12/2020 18:59	08/12/2020 19:03	08/12/2020 18:59	08/12/2020 19:03	0,07	96	6,40	CHI
2020120800104	ITABERAI	35502	ITABERAI S1	08/12/2020 18:59	08/12/2020 19:03	08/12/2020 18:59	08/12/2020 19:03	0,07	3	0,20	CHI
2020120800104	TAQUARAL DE GOIAS	35502	ITABERAI S1	08/12/2020 18:59	08/12/2020 19:03	08/12/2020 18:59	08/12/2020 19:03	0,07	140	9,33	CHI
2020120800104	ITAUCU	00880404	ITABERAI S1	08/12/2020 18:59	08/12/2020 19:03	08/12/2020 18:59	08/12/2020 19:03	0,07	3	0,20	CHI
2020120800104	TAQUARAL DE GOIAS	00880404	ITABERAI S1	08/12/2020 18:59	08/12/2020 19:03	08/12/2020 18:59	08/12/2020 19:03	0,07	3	0,20	CHI
2020120800104	HEITORAI	00880424	ITABERAI S1	08/12/2020 18:59	08/12/2020 19:03	08/12/2020 18:59	08/12/2020 19:03	0,07	2	0,13	CHI
20201243172	LUZIANIA	LZ11133120	MARAJOARA	08/12/2020 19:00	08/12/2020 22:04	08/12/2020 19:00	08/12/2020 22:04	3,05	217	662,33	CHI

20201243261	URUANA	HE10400390	ITAPURANGA	08/12/2020 19:00	08/12/2020 19:55	08/12/2020 19:00	08/12/2020 19:55	0,93	1	0,93	CHI
20201243261	ITABERAI	HE10400390	ITABERAI S1	08/12/2020 19:00	08/12/2020 19:55	08/12/2020 19:00	08/12/2020 19:55	0,93	75	69,56	CHI
20201243261	GOIAS	HE10400390	ITAPURANGA	08/12/2020 19:00	08/12/2020 19:55	08/12/2020 19:00	08/12/2020 19:55	0,93	76	70,49	CHI
20201243261	GOIAS	HE10400390	ITABERAI S1	08/12/2020 19:00	08/12/2020 19:55	08/12/2020 19:00	08/12/2020 19:55	0,93	40	37,10	CHI
20201243261	HEITORAI	HE10400390	ITABERAI S1	08/12/2020 19:00	08/12/2020 19:55	08/12/2020 19:00	08/12/2020 19:55	0,93	25	23,19	CHI
20201243261	HEITORAI	HE10400390	ITAPURANGA	08/12/2020 19:00	08/12/2020 19:55	08/12/2020 19:00	08/12/2020 19:55	0,93	166	153,96	CHI
20201243261	ITAPURANGA	HE10400390	ITAPURANGA	08/12/2020 19:00	08/12/2020 19:55	08/12/2020 19:00	08/12/2020 19:55	0,93	85	78,84	CHI
20201243261	HEITORAI	HE10400390	ITAPURANGA	08/12/2020 19:00	08/12/2020 19:55	08/12/2020 19:00	08/12/2020 19:55	0,93	1461	1355,08	CHI
20201243261	ITAGUARU	HE10400390	ITAPURANGA	08/12/2020 19:00	08/12/2020 19:55	08/12/2020 19:00	08/12/2020 19:55	0,93	56	51,94	CHI
20201243261	ITAPURANGA	HE10400390	ITAPURANGA	08/12/2020 19:00	08/12/2020 19:55	08/12/2020 19:00	08/12/2020 19:55	0,93	76	70,49	CHI
20201245110	SANTA FE DE GOIAS	RN12009764	BRITANIA	08/12/2020 19:00	09/12/2020 08:54	08/12/2020 19:00	09/12/2020 08:54	13,89	6	83,36	CHI
20201243182	MAURILANDIA	1040010213	RIO DOS BOIS	08/12/2020 19:01	09/12/2020 13:58	08/12/2020 19:01	09/12/2020 13:58	18,94	1	18,94	CHI
20201243189	PIRANHAS	PH12204965	PIRANHAS	08/12/2020 19:01	08/12/2020 19:54	08/12/2020 19:01	08/12/2020 19:54	0,87	4	3,47	CHI
20201244632	JARAGUA	JA21040517	ITABERAI S1	08/12/2020 19:01	09/12/2020 08:36	08/12/2020 19:01	09/12/2020 08:36	13,58	1	13,58	CHI
202012179455	TAQUARAL DE GOIAS	30202	ITABERAI S1	08/12/2020 19:01	08/12/2020 21:57	08/12/2020 19:01	08/12/2020 21:57	2,94	172	505,35	CHI
202012179455	TAQUARAL DE GOIAS	30201	ITABERAI S1	08/12/2020 19:01	08/12/2020 21:57	08/12/2020 19:01	08/12/2020 21:57	2,94	47	138,09	CHI
202012179455	ITAGUARU	30230	ITABERAI S1	08/12/2020 19:01	08/12/2020 21:57	08/12/2020 19:01	08/12/2020 21:57	2,94	5	14,69	CHI
202012179455	JARAGUA	30230	ITABERAI S1	08/12/2020 19:01	08/12/2020 21:57	08/12/2020 19:01	08/12/2020 21:57	2,94	3	8,81	CHI
202012179455	ITAGUARU	30202	ITABERAI S1	08/12/2020 19:01	08/12/2020 21:57	08/12/2020 19:01	08/12/2020 21:57	2,94	0	0,00	CHI
202012179455	ITABERAI	30202	ITABERAI S1	08/12/2020 19:01	08/12/2020 21:57	08/12/2020 19:01	08/12/2020 21:57	2,94	6	17,63	CHI
202012179455	ITABERAI	30201	ITABERAI S1	08/12/2020 19:01	08/12/2020 21:57	08/12/2020 19:01	08/12/2020 21:57	2,94	22	64,64	CHI
202012179455	HEITORAI	30602	ITABERAI S1	08/12/2020 19:01	08/12/2020 21:57	08/12/2020 19:01	08/12/2020 21:57	2,94	8	23,50	CHI
202012179455	ITAGUARI	30202	ITABERAI S1	08/12/2020 19:01	08/12/2020 21:57	08/12/2020 19:01	08/12/2020 21:57	2,94	1278	3754,84	CHI
202012179455	URUANA	30601	ITABERAI S1	08/12/2020 19:01	08/12/2020 21:57	08/12/2020 19:01	08/12/2020 21:57	2,94	10	29,38	CHI
202012179455	TAQUARAL DE GOIAS	00880444	ITABERAI S1	08/12/2020 19:01	08/12/2020 21:57	08/12/2020 19:01	08/12/2020 21:57	2,94	6	17,63	CHI
202012179455	ITAGUARI	30201	ITABERAI S1	08/12/2020 19:01	08/12/2020 21:57	08/12/2020 19:01	08/12/2020 21:57	2,94	152	446,58	CHI
202012179455	ITAGUARI	30201	ITABERAI S1	08/12/2020 19:01	08/12/2020 21:57	08/12/2020 19:01	08/12/2020 21:57	2,94	1008	2961,56	CHI
202012179455	ITABERAI	30602	ITABERAI S1	08/12/2020 19:01	08/12/2020 21:57	08/12/2020 19:01	08/12/2020 21:57	2,94	4	11,75	CHI
202012179455	ITAGUARU	30602	ITABERAI S1	08/12/2020 19:01	08/12/2020 21:57	08/12/2020 19:01	08/12/2020 21:57	2,94	2154	6328,57	CHI
202012179455	ITAGUARI	00880444	ITABERAI S1	08/12/2020 19:01	08/12/2020 21:57	08/12/2020 19:01	08/12/2020 21:57	2,94	9	26,44	CHI
202012179455	ITAGUARU	30601	ITABERAI S1	08/12/2020 19:01	08/12/2020 21:57	08/12/2020 19:01	08/12/2020 21:57	2,94	180	528,85	CHI
202012179455	ITABERAI	00880444	ITABERAI S1	08/12/2020 19:01	08/12/2020 21:57	08/12/2020 19:01	08/12/2020 21:57	2,94	63	185,10	CHI
202012179455	JARAGUA	30601	ITABERAI S1	08/12/2020 19:01	08/12/2020 21:57	08/12/2020 19:01	08/12/2020 21:57	2,94	130	381,95	CHI
202012179455	ITAGUARI	30230	ITABERAI S1	08/12/2020 19:01	08/12/2020 21:57	08/12/2020 19:01	08/12/2020 21:57	2,94	127	373,13	CHI
202012179455	JARAGUA	30202	ITABERAI S1	08/12/2020 19:01	08/12/2020 21:57	08/12/2020 19:01	08/12/2020 21:57	2,94	273	802,09	CHI
202012179455	JESUPOLIS	30202	ITABERAI S1	08/12/2020 19:01	08/12/2020 21:57	08/12/2020 19:01	08/12/2020 21:57	2,94	1	2,94	CHI
202012179455	ITAGUARI	30601	ITABERAI S1	08/12/2020 19:01	08/12/2020 21:57	08/12/2020 19:01	08/12/2020 21:57	2,94	102	299,68	CHI
20201243196	ALEXANIA	AX11221364	ALEXANIA	08/12/2020 19:02	09/12/2020 01:54	08/12/2020 19:02	09/12/2020 01:54	6,86	36	246,82	CHI
20201243203	ITABERAI	IB12300330	ITABERAI S2	08/12/2020 19:02	09/12/2020 10:24	08/12/2020 19:02	09/12/2020 10:24	15,35	14	214,91	CHI
20201243209	NOVO BRASIL	NB12396240	JUSSARA	08/12/2020 19:03	09/12/2020 16:17	08/12/2020 19:03	09/12/2020 16:17	21,23	10	212,28	CHI
20201243215	ARAGUAPAZ	AZ12198854	GOIAS	08/12/2020 19:03	09/12/2020 09:09	08/12/2020 19:03	09/12/2020 09:09	14,10	10	140,97	CHI
20201243337	POSSE	PS12132047	IACIARA S2	08/12/2020 19:03	08/12/2020 20:05	08/12/2020 19:03	08/12/2020 20:05	1,03	7	7,24	CHI
20201243219	SANTO ANTONIO DO DESCOBERTO	SN21086752	ALEXANIA	08/12/2020 19:04	09/12/2020 08:04	08/12/2020 19:04	09/12/2020 08:04	13,00	1	13,00	CHI
20201243229	GOIANIA	10710553	CAMPINAS S3	08/12/2020 19:05	08/12/2020 21:03	08/12/2020 19:05	08/12/2020 21:03	1,96	1	1,96	CHI
20201243369	MUNDO NOVO DE GOIAS	NA12035650	NOVA CRIXAS	08/12/2020 19:05	08/12/2020 22:40	08/12/2020 19:05	08/12/2020 22:40	3,58	8	28,66	CHI
20201243369	NOVA CRIXAS	NA12035650	NOVA CRIXAS	08/12/2020 19:05	08/12/2020 22:40	08/12/2020 19:05	08/12/2020 22:40	3,58	24	85,99	CHI
20201243300	NOVA CRIXAS	NA21315111	NOVA CRIXAS	08/12/2020 19:05	09/12/2020 10:37	08/12/2020 19:05	09/12/2020 10:37	15,53	1	15,53	CHI
20201243239	MOSSAMEDES	MD21376382	FIRMINOPOLIS S2	08/12/2020 19:06	09/12/2020 13:31	08/12/2020 19:06	09/12/2020 13:31	18,41	1	18,41	CHI
20201243248	CIDADE OCIDENTAL	2680037486	MARAJOARA	08/12/2020 19:07	08/12/2020 22:49	08/12/2020 19:07	08/12/2020 22:49	3,70	1	3,70	CHI
20201243270	SAO JOAO D ALIANCA	JL21388380	SAO JOAO D ALIANCA	08/12/2020 19:08	09/12/2020 11:58	08/12/2020 19:08	09/12/2020 11:58	16,82	1	16,82	CHI
20201243273	BURITI DE GOIAS	BS21099777	FIRMINOPOLIS S2	08/12/2020 19:08	09/12/2020 10:14	08/12/2020 19:08	09/12/2020 10:14	15,09	1	15,09	CHI

20201243538	ITABERAÍ	IB31171745	ITABERAÍ S2	08/12/2020 19:26	09/12/2020 08:46	08/12/2020 19:26	09/12/2020 08:46	13,33	1	13,33	CHI
20201243552	CACHOEIRA DE GOIÁS	CG21153738	FIRMINÓPOLIS S2	08/12/2020 19:27	10/12/2020 01:53	08/12/2020 19:27	10/12/2020 01:53	30,43	1	30,43	CHI
20201243553	PALMEIRAS DE GOIÁS	PL12047802	PALMEIRAS	08/12/2020 19:27	09/12/2020 11:16	08/12/2020 19:27	09/12/2020 11:16	15,81	1	15,81	CHI
20201243559	MONTIVÍDIU	MV21402607	MONTIVÍDIU T	08/12/2020 19:27	08/12/2020 23:58	08/12/2020 19:27	08/12/2020 23:58	4,50	1	4,50	CHI
20201243566	GOIANDIRA	CT21075578	CATALAO S1	08/12/2020 19:28	08/12/2020 23:27	08/12/2020 19:28	08/12/2020 23:27	3,97	1	3,97	CHI
20201243575	AMORINÓPOLIS	AM21000027	IPORA	08/12/2020 19:29	09/12/2020 00:30	08/12/2020 19:29	09/12/2020 00:30	5,01	1	5,01	CHI
20201243587	CACHOEIRA ALTA	CA12384078	CACHOEIRA ALTA	08/12/2020 19:29	09/12/2020 01:27	08/12/2020 19:29	09/12/2020 01:27	5,96	8	47,64	CHI
20201243587	CACU	CA12384078	CACHOEIRA ALTA	08/12/2020 19:29	09/12/2020 01:27	08/12/2020 19:29	09/12/2020 01:27	5,96	1	5,96	CHI
20201243581	RIO VERDE	RV21207143	CABRIUVA S2	08/12/2020 19:30	09/12/2020 11:46	08/12/2020 19:30	09/12/2020 11:46	16,26	1	16,26	CHI
20201243583	GAMELEIRA DE GOIÁS	SV21161123	DAIA S2	08/12/2020 19:30	08/12/2020 23:07	08/12/2020 19:30	08/12/2020 23:07	3,61	2	7,21	CHI
20201244903	GOIATUBA	JV12222565RE	VICENTINÓPOLIS	08/12/2020 19:30	09/12/2020 07:21	08/12/2020 19:30	09/12/2020 07:21	11,84	15	177,54	CHI
20201244903	JOVIANIA	JV12222565RE	VICENTINÓPOLIS	08/12/2020 19:30	09/12/2020 07:21	08/12/2020 19:30	09/12/2020 07:21	11,84	6	71,02	CHI
20201244903	BOM JESUS DE GOIÁS	JV12222565RE	VICENTINÓPOLIS	08/12/2020 19:30	09/12/2020 07:21	08/12/2020 19:30	09/12/2020 07:21	11,84	3	35,51	CHI
20201244903	VICENTINÓPOLIS	JV12222565RE	VICENTINÓPOLIS	08/12/2020 19:30	09/12/2020 07:21	08/12/2020 19:30	09/12/2020 07:21	11,84	2	23,67	CHI
20201243589	SILVANIA	SV12056199	DAIA S2	08/12/2020 19:31	08/12/2020 21:19	08/12/2020 19:31	08/12/2020 21:19	1,80	9	16,18	CHI
20201244899	MOZARLANDIA	AZ12290380	MOZARLANDIA	08/12/2020 19:31	09/12/2020 09:52	08/12/2020 19:31	09/12/2020 09:52	14,34	2	28,68	CHI
20201244899	ARAGUAPAZ	AZ12290380	MOZARLANDIA	08/12/2020 19:31	09/12/2020 09:52	08/12/2020 19:31	09/12/2020 09:52	14,34	7	100,38	CHI
20201243600	ITUMBIAIRA	IT21392092	ITUMBIAIRA NOVA	08/12/2020 19:32	08/12/2020 21:55	08/12/2020 19:32	08/12/2020 21:55	2,38	1	2,38	CHI
20201243931	DAVINÓPOLIS	IO12073927	CATALAO S1	08/12/2020 19:32	08/12/2020 22:26	08/12/2020 19:32	08/12/2020 22:26	2,89	47	135,93	CHI
20201243619	JATAÍ	JT11083816	JATAÍ S2	08/12/2020 19:33	08/12/2020 21:48	08/12/2020 19:33	08/12/2020 21:48	2,24	1	2,24	CHI
20201243935	CATALAO	CT12399851	CATALAO S1	08/12/2020 19:33	09/12/2020 07:12	08/12/2020 19:33	09/12/2020 07:12	11,64	74	861,30	CHI
20201243642	ALEXANIA	AX12071326	ALEXANIA	08/12/2020 19:34	09/12/2020 12:36	08/12/2020 19:34	09/12/2020 12:36	17,02	2	34,04	CHI
20201243655	INACIOLANDIA	CD12000137	CACHOEIRA DOURADA	08/12/2020 19:36	08/12/2020 23:41	08/12/2020 19:36	08/12/2020 23:41	4,07	16	65,19	CHI
20201243667	QUIRINÓPOLIS	QI21160733	QUIRINÓPOLIS	08/12/2020 19:37	09/12/2020 09:36	08/12/2020 19:37	09/12/2020 09:36	13,97	1	13,97	CHI
20201246317	ITAPIRAPUA	JR12087418	JUSSARA	08/12/2020 19:38	09/12/2020 09:53	08/12/2020 19:38	09/12/2020 09:53	14,25	1	14,25	CHI
20201246317	JUSSARA	JR12087418	JUSSARA	08/12/2020 19:38	09/12/2020 09:53	08/12/2020 19:38	09/12/2020 09:53	14,25	11	156,75	CHI
20201243693	OUVIDOR	OU21157918	CATALAO S1	08/12/2020 19:39	08/12/2020 21:19	08/12/2020 19:39	08/12/2020 21:19	1,66	1	1,66	CHI
20201243694	CORUMBAIBA	CI21092074	CATALAO S1	08/12/2020 19:39	09/12/2020 20:59	08/12/2020 19:39	09/12/2020 20:59	25,32	1	25,32	CHI
20201243697	PEROLANDIA	DP11272511	JATAÍ S1	08/12/2020 19:40	09/12/2020 14:54	08/12/2020 19:40	09/12/2020 14:54	19,23	1	19,23	CHI
20201243701	GOIÁS	GS11165414	ITABERAÍ S1	08/12/2020 19:40	09/12/2020 10:41	08/12/2020 19:40	09/12/2020 10:41	15,01	92	1381,02	CHI
20201243709	VIANÓPOLIS	10031865559	VIANÓPOLIS	08/12/2020 19:41	09/12/2020 10:27	08/12/2020 19:41	09/12/2020 10:27	14,76	1	14,76	CHI
20201244492	TAQUARAL DE GOIÁS	TQ12250778	INHUMAS S1	08/12/2020 19:41	09/12/2020 12:28	08/12/2020 19:41	09/12/2020 12:28	16,77	39	654,05	CHI
20201249076	FAZENDA NOVA	FN12013300	FIRMINÓPOLIS S2	08/12/2020 19:41	09/12/2020 18:21	08/12/2020 19:41	09/12/2020 18:21	22,66	9	203,92	CHI
20201243716	MATRINCHA	4370000763	MATRINCHA	08/12/2020 19:42	09/12/2020 12:45	08/12/2020 19:42	09/12/2020 12:45	17,07	1	17,07	CHI
20201243726	CALDAS NOVAS	760209820	CALDAS NOVAS S1	08/12/2020 19:43	09/12/2020 13:10	08/12/2020 19:43	09/12/2020 13:10	17,44	1	17,44	CHI
20201243727	MINEIROS	10014387393	PARQUE DAS EMAS	08/12/2020 19:43	09/12/2020 04:00	08/12/2020 19:43	09/12/2020 04:00	8,28	1	8,28	CHI
20201245209	IPAMERI	IP12027098	URUTAI	08/12/2020 19:43	09/12/2020 10:27	08/12/2020 19:43	09/12/2020 10:27	14,74	9	132,63	CHI
20201243735	VICENTINÓPOLIS	VI12218172	VICENTINÓPOLIS	08/12/2020 19:44	08/12/2020 23:25	08/12/2020 19:44	08/12/2020 23:25	3,67	2	7,34	CHI
20201244307	CIDADE OCIDENTAL	DH11199624	MARAJÓARA	08/12/2020 19:44	09/12/2020 09:46	08/12/2020 19:44	09/12/2020 09:46	14,03	80	1122,40	CHI
20201243740	JATAÍ	290087624	JATAÍ S2	08/12/2020 19:45	09/12/2020 00:07	08/12/2020 19:45	09/12/2020 00:07	4,36	1	4,36	CHI
20201243741	LUZIANIA	LZ21120159	MARAJÓARA	08/12/2020 19:45	09/12/2020 10:13	08/12/2020 19:45	09/12/2020 10:13	14,46	1	14,46	CHI
20201243744	MONTES CLAROS DE GOIÁS	ME21322040	IPORA	08/12/2020 19:45	09/12/2020 11:01	08/12/2020 19:45	09/12/2020 11:01	15,26	1	15,26	CHI
20201243745	GOIANIA	12169924	ATLANTICO S3	08/12/2020 19:45	08/12/2020 21:11	08/12/2020 19:45	08/12/2020 21:11	1,42	1	1,42	CHI
20201243747	SANTO ANTONIO DO DESCOBERTO	SN21139297	ALEXANIA	08/12/2020 19:46	09/12/2020 08:43	08/12/2020 19:46	09/12/2020 08:43	12,95	1	12,95	CHI
20201243759	SAO LUIS DE MONTES BELOS	500020681	SAO LUIZ DOS MONTES BELOS	08/12/2020 19:48	09/12/2020 19:44	08/12/2020 19:48	09/12/2020 19:44	23,93	1	23,93	CHI
20201243763	PORANGATU	PO12064910	NOVO PLANALTO	08/12/2020 19:48	08/12/2020 23:30	08/12/2020 19:48	08/12/2020 23:30	3,69	8	29,56	CHI
20201244609	MINACU	IH12245144	MINACU	08/12/2020 19:48	08/12/2020 12:08	08/12/2020 19:48	09/12/2020 12:08	16,33	6	98,00	CHI
20201249074	FAZENDA NOVA	FN12383522	FIRMINÓPOLIS S2	08/12/2020 19:48	09/12/2020 17:42	08/12/2020 19:48	09/12/2020 17:42	21,88	8	175,07	CHI
20201243778	GOIANIA	GN12232724	CAMPINAS S2	08/12/2020 19:50	09/12/2020 12:30	08/12/2020 19:50	09/12/2020 12:00	16,16	1	16,16	CHI
20201243778	GOIANIA	GN12232724	CAMPINAS S2	08/12/2020 19:50	09/12/2020 12:30	08/12/2020 19:50	09/12/2020 12:30	16,66	2	33,32	CHI
20201243785	JATAÍ	JT12347805	MONTIVÍDIU T	08/12/2020 19:51	09/12/2020 16:29	08/12/2020 19:51	09/12/2020 16:29	20,63	1	20,63	CHI

20201243962	SAO LUIS DE MONTES BELOS	SL32145768	SAO LUIZ DOS MONTES BELOS	08/12/2020 19:51	09/12/2020 23:12	08/12/2020 19:51	09/12/2020 05:17	9,44	17	160,40	CHI
20201243962	SAO LUIS DE MONTES BELOS	SL32145768	SAO LUIZ DOS MONTES BELOS	08/12/2020 19:51	09/12/2020 23:12	08/12/2020 19:51	09/12/2020 23:12	27,36	12	328,28	CHI
20201243962	SAO LUIS DE MONTES BELOS	SL32145768	SAO LUIZ DOS MONTES BELOS	08/12/2020 19:51	09/12/2020 23:12	09/12/2020 22:31	09/12/2020 23:12	0,69	17	11,69	CHI
20201244213	FORMOSA	FA13404976	ITIQUEIRA	08/12/2020 19:51	09/12/2020 17:07	08/12/2020 19:51	09/12/2020 17:07	21,26	51	1084,20	CHI
20201244213	FORMOSA	FA13404976	ITIQUEIRA	08/12/2020 19:51	09/12/2020 17:07	09/12/2020 16:04	09/12/2020 17:07	1,05	127	133,35	CHI
20201243817	CIDADE OCIDENTAL	LZ12219730	MARAJOARA	08/12/2020 19:54	09/12/2020 17:43	08/12/2020 19:54	09/12/2020 17:43	21,80	4	87,22	CHI
20201243818	ANAPOLIS	10027626693	ANAPOLIS UNIVERSITARIO S2	08/12/2020 19:54	09/12/2020 01:02	08/12/2020 19:54	09/12/2020 01:02	5,12	1	5,12	CHI
20201243820	AGUA LIMPA	AL21240034	VILA CORUMBA	08/12/2020 19:54	09/12/2020 16:06	08/12/2020 19:54	09/12/2020 16:06	20,19	1	20,19	CHI
20201243824	MORRINHOS	MR12000135RE	GOIATUBA S1	08/12/2020 19:55	09/12/2020 06:46	08/12/2020 19:55	09/12/2020 06:46	10,84	133	1441,83	CHI
20201243831	MONTES CLAROS DE GOIAS	8010000178	IPORA	08/12/2020 19:55	09/12/2020 23:19	08/12/2020 19:55	09/12/2020 23:19	27,40	1	27,40	CHI
20201243832	INACIOLANDIA	CD12000116	CACHOEIRA DOURADA	08/12/2020 19:56	09/12/2020 12:40	08/12/2020 19:56	09/12/2020 12:40	16,75	13	217,69	CHI
20201243834	SAO JOAO D ALIANCA	JL11280297	SAO JOAO D ALIANCA	08/12/2020 19:56	09/12/2020 14:45	08/12/2020 19:56	09/12/2020 14:45	18,82	9	169,34	CHI
20201243837	PONTALINA	PK12401674	PONTALINA	08/12/2020 19:56	08/12/2020 23:15	08/12/2020 19:56	08/12/2020 23:15	3,31	3	9,92	CHI
20201243842	SANTO ANTONIO DO DESCOBERTO	SN12168725	AGUAS LINDAS DE GOIAS S2	08/12/2020 19:56	08/12/2020 22:41	08/12/2020 19:56	08/12/2020 22:41	2,74	124	339,48	CHI
20201244268	NOVA CRIXAS	NA12091692	NOVA CRIXAS	08/12/2020 19:56	09/12/2020 18:20	08/12/2020 19:56	09/12/2020 18:20	22,40	23	515,09	CHI
20201243845	VILA PROPICIO	PV12115149	GOIANESIA S1	08/12/2020 19:57	09/12/2020 20:56	08/12/2020 19:57	09/12/2020 20:56	24,98	2	49,95	CHI
20201243845	PIRENOPOLIS	PV12115149	GOIANESIA S1	08/12/2020 19:57	09/12/2020 20:56	08/12/2020 19:57	09/12/2020 20:56	24,98	2	49,95	CHI
20201246928	FIRMINOPOLIS	FR12061354	FIRMINOPOLIS S1	08/12/2020 19:57	09/12/2020 14:27	08/12/2020 19:57	09/12/2020 14:27	18,50	20	369,93	CHI
20201244218	PALMEIRAS DE GOIAS	PL13000016	PALMEIRAS	08/12/2020 19:58	09/12/2020 15:50	08/12/2020 19:58	09/12/2020 15:50	19,88	47	934,36	CHI
20201244218	PALMEIRAS DE GOIAS	PL13000016	PALMEIRAS	08/12/2020 19:58	09/12/2020 15:50	09/12/2020 12:18	09/12/2020 15:50	3,54	3	10,61	CHI
20201243859	CRIXAS	NA13309256	MOZARLANDIA	08/12/2020 19:59	10/12/2020 21:20	08/12/2020 19:59	10/12/2020 21:20	49,35	1	49,35	CHI
20201243859	NOVA CRIXAS	NA13309256	MOZARLANDIA	08/12/2020 19:59	10/12/2020 21:20	08/12/2020 19:59	10/12/2020 21:20	49,35	28	1381,89	CHI
20201243873	CRIXAS	CX12190130	SANTA TEREZINHA	08/12/2020 20:00	08/12/2020 23:33	08/12/2020 20:00	08/12/2020 23:33	3,54	7	24,78	CHI
20201244334	BELA VISTA DE GOIAS	BV11045927	BELA VISTA S1	08/12/2020 20:00	08/12/2020 22:05	08/12/2020 20:00	08/12/2020 22:05	2,08	190	394,99	CHI
20201243883	JARAGUA	JA21314105	JARAGUA	08/12/2020 20:01	09/12/2020 10:47	08/12/2020 20:01	09/12/2020 10:47	14,76	2	29,52	CHI
20201244013	MATRINCHA	MP12010442	MOZARLANDIA	08/12/2020 20:02	09/12/2020 16:11	08/12/2020 20:02	09/12/2020 16:11	20,15	4	80,58	CHI
20201245102	GOIANIA	GN11201574	GOYA S1	08/12/2020 20:02	09/12/2020 03:46	08/12/2020 20:02	09/12/2020 03:46	7,73	108	834,66	CHI
20201243901	RIO VERDE	630473791	RIO VERDE S1	08/12/2020 20:03	09/12/2020 09:56	08/12/2020 20:03	09/12/2020 09:56	13,89	1	13,89	CHI
20201243955	SAO LUIS DE MONTES BELOS	SL12053971	SAO LUIZ DOS MONTES BELOS	08/12/2020 20:03	09/12/2020 07:44	08/12/2020 20:03	09/12/2020 07:44	11,68	12	140,12	CHI
20201245210	IPAMERI	IP12215693	URUTAI	08/12/2020 20:03	09/12/2020 17:31	08/12/2020 20:03	09/12/2020 17:31	21,46	4	85,82	CHI
20201245639	BOM JESUS DE GOIAS	BJ12068991	BOM JESUS DE GOIAS	08/12/2020 20:03	09/12/2020 09:52	08/12/2020 20:03	09/12/2020 09:52	13,81	10	138,10	CHI
20201243909	SAO LUIS DE MONTES BELOS	500067673	SAO LUIZ DOS MONTES BELOS	08/12/2020 20:04	09/12/2020 18:39	08/12/2020 20:04	09/12/2020 18:39	22,59	1	22,59	CHI
20201243913	FORMOSO	TB12372648	PORANGATU	08/12/2020 20:04	09/12/2020 01:09	08/12/2020 20:04	09/12/2020 01:09	5,08	1	5,08	CHI
20201243913	TROMBAS	TB12372648	PORANGATU	08/12/2020 20:04	09/12/2020 01:09	08/12/2020 20:04	09/12/2020 01:09	5,08	67	340,27	CHI
20201244536	LUZIANIA	LZ12376265	MARAJOARA	08/12/2020 20:04	09/12/2020 00:46	08/12/2020 20:04	09/12/2020 00:46	4,70	2	9,39	CHI
20201243918	RUBIATABA	RB12110450	RUBIATABA	08/12/2020 20:05	09/12/2020 18:19	08/12/2020 20:05	09/12/2020 18:19	22,23	3	66,69	CHI
20201243925	FIRMINOPOLIS	FR11076439	FIRMINOPOLIS S1	08/12/2020 20:05	09/12/2020 00:05	08/12/2020 20:05	09/12/2020 00:05	3,99	87	346,79	CHI
20201245454	FAINA	GS12042217	GOIAS	08/12/2020 20:05	09/12/2020 10:35	08/12/2020 20:05	09/12/2020 10:35	14,49	59	855,02	CHI
20201243941	CORREGO DO OURO	CO12048088	SAO LUIZ DOS MONTES BELOS	08/12/2020 20:08	09/12/2020 15:50	08/12/2020 20:08	09/12/2020 15:50	19,70	7	137,88	CHI
20201243944	RIO VERDE	10003972320	CABRIUVA S1	08/12/2020 20:08	08/12/2020 23:41	08/12/2020 20:08	08/12/2020 23:41	3,54	1	3,54	CHI
20201243995	TRINDADE	TR11129061	TRINDADE	08/12/2020 20:09	08/12/2020 21:26	08/12/2020 20:09	08/12/2020 21:26	1,27	106	134,38	CHI
20201244022	FORMOSA	FA11000014	ITIQUEIRA	08/12/2020 20:11	08/12/2020 23:10	08/12/2020 20:11	08/12/2020 23:10	2,98	184	547,40	CHI
20201243981	SANTA HELENA DE GOIAS	400064947	IPEGUARI	08/12/2020 20:12	09/12/2020 00:02	08/12/2020 20:12	09/12/2020 00:02	3,82	1	3,82	CHI
20201244151	NEROPOLIS	NR12000048	NEROPOLIS S2	08/12/2020 20:12	09/12/2020 04:02	08/12/2020 20:12	09/12/2020 04:02	7,83	16	125,28	CHI
20201243989	MOIPORA	MO21006812	SAO LUIZ DOS MONTES BELOS	08/12/2020 20:13	09/12/2020 08:27	08/12/2020 20:13	09/12/2020 08:27	12,23	1	12,23	CHI
20201243993	SANTA ROSA DE GOIAS	SR12019043	INHUMAS S1	08/12/2020 20:13	10/12/2020 11:06	08/12/2020 20:13	10/12/2020 11:06	38,87	3	116,62	CHI
20201244202	ANAPOLIS	AN12377436	ANAPOLIS UNIVERSITARIO S1	08/12/2020 20:13	08/12/2020 23:25	08/12/2020 20:13	08/12/2020 23:25	3,18	860	2738,38	CHI
20201244204	NOVA VENEZA	NV12200061	INHUMAS S1	08/12/2020 20:13	08/12/2020 22:24	08/12/2020 20:13	08/12/2020 22:24	2,18	283	615,60	CHI
20201244004	CIDADE OCIDENTAL	O2900216	MARAJOARA	08/12/2020 20:14	09/12/2020 13:00	08/12/2020 20:14	09/12/2020 13:00	16,75	21	351,84	CHI
20201244059	FORMOSA	FA11131847	ITIQUEIRA	08/12/2020 20:14	08/12/2020 21:54	08/12/2020 20:14	08/12/2020 21:54	1,66	182	302,52	CHI
20201244510	SENADOR CANEDO	SW11076743	CEPAIGO S1	08/12/2020 20:14	09/12/2020 00:10	08/12/2020 20:14	09/12/2020 00:10	3,92	12	47,01	CHI

20201245425	FORMOSA	FA12195886LD	ITUIQUIRA	08/12/2020 20:14	09/12/2020 07:42	08/12/2020 20:14	09/12/2020 07:42	11,46	48	549,85	CHI
20201245558	FAINA	AZ12259733	GOIAS	08/12/2020 20:14	09/12/2020 13:22	08/12/2020 20:14	09/12/2020 13:22	17,12	9	154,09	CHI
20201245558	ARAGUAPAZ	AZ12259733	GOIAS	08/12/2020 20:14	09/12/2020 13:22	08/12/2020 20:14	09/12/2020 13:22	17,12	24	410,91	CHI
20201244019	PALMEIRAS DE GOIAS	590007750	PALMEIRAS	08/12/2020 20:16	09/12/2020 07:15	08/12/2020 20:16	09/12/2020 07:15	10,98	1	10,98	CHI
20201244021	BELA VISTA DE GOIAS	BV31097984	BELA VISTA S1	08/12/2020 20:16	08/12/2020 23:24	08/12/2020 20:16	08/12/2020 23:24	3,13	2	6,25	CHI
20201244024	FIRMINOPOLIS	900009792	FIRMINOPOLIS S1	08/12/2020 20:16	10/12/2020 06:11	08/12/2020 20:16	10/12/2020 06:11	33,92	1	33,92	CHI
20201244038	MONTES CLAROS DE GOIAS	ME12380972	IPORA	08/12/2020 20:17	09/12/2020 17:12	08/12/2020 20:17	09/12/2020 17:12	20,90	8	167,22	CHI
20201244446	FAINA	FC12147790	GOIAS	08/12/2020 20:17	09/12/2020 08:58	08/12/2020 20:17	09/12/2020 08:58	12,67	6	76,01	CHI
20201244538	JANDAIA	JD11244804	PALMEIRAS	08/12/2020 20:17	09/12/2020 00:58	08/12/2020 20:17	09/12/2020 00:58	4,67	46	214,73	CHI
20201244040	LEOPOLDO DE BULHOES	LB21387912	DAIA S2	08/12/2020 20:18	09/12/2020 09:01	08/12/2020 20:18	09/12/2020 09:01	12,70	2	25,40	CHI
20201244999	FORMOSA	FA12404379	ITUIQUIRA	08/12/2020 20:18	09/12/2020 14:41	08/12/2020 20:18	09/12/2020 14:41	18,38	12	220,55	CHI
20201244044	CACU	CC21340927	CACHOEIRA ALTA	08/12/2020 20:19	09/12/2020 14:46	08/12/2020 20:19	09/12/2020 14:46	18,45	1	18,45	CHI
20201244046	JATAI	290146422	JATAI S3	08/12/2020 20:19	09/12/2020 01:02	08/12/2020 20:19	09/12/2020 01:02	4,71	1	4,71	CHI
20201244047	JARAGUA	JA12298032	JARAGUA	08/12/2020 20:19	09/12/2020 10:47	08/12/2020 20:19	09/12/2020 10:47	14,46	139	2010,06	CHI
20201244052	CATALAO	CT12250355	CATALAO S1	08/12/2020 20:20	09/12/2020 00:16	08/12/2020 20:20	09/12/2020 00:16	3,93	7	27,54	CHI
20201244054	GOIANIA	14960977	XAVANTES	08/12/2020 20:20	09/12/2020 05:42	08/12/2020 20:20	09/12/2020 05:42	9,36	1	9,36	CHI
20201244061	MORRINHOS	MR11378315	MORRINHOS	08/12/2020 20:21	09/12/2020 01:47	08/12/2020 20:21	09/12/2020 01:47	5,43	14	75,98	CHI
20201244171	GOIANIA	GN11189608	GOIANIA LESTE S3	08/12/2020 20:23	09/12/2020 02:04	08/12/2020 20:23	09/12/2020 02:04	5,68	133	756,07	CHI
20201243912	GOIATUBA	GT12044903	GOIATUBA S2	08/12/2020 20:24	09/12/2020 09:00	08/12/2020 20:24	09/12/2020 09:00	12,60	8	100,78	CHI
20201243912	MORRINHOS	GT12044903	GOIATUBA S2	08/12/2020 20:24	09/12/2020 09:00	08/12/2020 20:24	09/12/2020 09:00	12,60	3	37,79	CHI
20201244075	SAO LUIZ DO NORTE	SZ12332178	BARRO ALTO	08/12/2020 20:24	09/12/2020 07:32	08/12/2020 20:24	09/12/2020 07:32	11,13	26	289,42	CHI
20201244085	JATAI	JT21063306	JATAI S1	08/12/2020 20:25	08/12/2020 22:25	08/12/2020 20:25	08/12/2020 22:25	2,00	2	3,99	CHI
20201244436	TURVELANDIA	TD12301554	RIO DOS BOIS	08/12/2020 20:25	09/12/2020 13:57	08/12/2020 20:25	09/12/2020 13:57	17,53	13	227,88	CHI
20201244099	CIDADE OCIDENTAL	DH21152861	MARAJOARA	08/12/2020 20:26	09/12/2020 10:35	08/12/2020 20:26	09/12/2020 10:35	14,14	1	14,14	CHI
20201244105	NOVA VENEZA	OV12272462	INHUMAS S1	08/12/2020 20:26	09/12/2020 03:07	08/12/2020 20:26	09/12/2020 03:07	6,67	11	73,34	CHI
20201244105	OURO VERDE DE GOIAS	OV12272462	INHUMAS S1	08/12/2020 20:26	09/12/2020 03:07	08/12/2020 20:26	09/12/2020 03:07	6,67	8	53,34	CHI
20201244485	GOIANIA	GN12329549	NEROPOLIS S1	08/12/2020 20:26	09/12/2020 00:20	08/12/2020 20:26	09/12/2020 00:20	3,89	14	54,42	CHI
20201244131	GOIANIA	GN11150494	GOYA S2	08/12/2020 20:27	08/12/2020 23:35	08/12/2020 20:27	08/12/2020 23:35	3,12	148	462,01	CHI
20201244358	ITABERAI	IB12206934	ITABERAI S2	08/12/2020 20:27	09/12/2020 11:50	08/12/2020 20:27	09/12/2020 11:50	15,38	18	276,85	CHI
20201244848	APARECIDA DE GOIANIA	AP11104054	ANHANGUERA	08/12/2020 20:28	09/12/2020 01:02	08/12/2020 20:28	09/12/2020 01:02	4,55	97	441,38	CHI
20201244140	ITABERAI	IB16407964	ITABERAI S2	08/12/2020 20:30	09/12/2020 05:41	08/12/2020 20:30	09/12/2020 05:26	8,92	542	4833,74	CHI
20201244140	ITABERAI	IB10406890	ITABERAI S2	08/12/2020 20:30	09/12/2020 05:41	09/12/2020 05:00	09/12/2020 05:26	0,43	1004	435,07	CHI
20201244140	ITABERAI	IB10406890	ITABERAI S2	08/12/2020 20:30	09/12/2020 05:41	09/12/2020 05:00	09/12/2020 05:41	0,68	1438	982,63	CHI
20201244165	GOIANIA	GN11002809	XAVANTES	08/12/2020 20:30	09/12/2020 05:30	08/12/2020 20:30	09/12/2020 05:30	8,98	172	1545,42	CHI
20201244247	GOIANIA	GN11002419	CAMPINAS S2	08/12/2020 20:30	09/12/2020 05:31	08/12/2020 20:30	09/12/2020 05:31	9,01	121	1089,94	CHI
20201244153	EDEIA	10032437682	EDEIA	08/12/2020 20:31	09/12/2020 00:19	08/12/2020 20:31	09/12/2020 00:19	3,79	1	3,79	CHI
20201244228	APARECIDA DE GOIANIA	AP11070531	INDEPENDENCIA S2	08/12/2020 20:31	09/12/2020 02:14	08/12/2020 20:31	09/12/2020 02:14	5,70	153	872,78	CHI
20201244162	PLANALTINA	10002823037	PLANALTINA	08/12/2020 20:32	09/12/2020 08:11	08/12/2020 20:32	09/12/2020 08:11	11,65	1	11,65	CHI
20201244164	VILA BOA	FA12042061	ITUIQUIRA	08/12/2020 20:32	08/12/2020 23:26	08/12/2020 20:32	08/12/2020 23:26	2,89	1	2,89	CHI
20201244192	MINACU	IH12360453	MINACU	08/12/2020 20:32	10/12/2020 18:55	08/12/2020 20:32	09/12/2020 11:17	14,74	47	692,94	CHI
20201244192	CAMPINACU	IH12360453	MINACU	08/12/2020 20:32	10/12/2020 18:55	08/12/2020 20:32	09/12/2020 11:17	14,74	5	73,72	CHI
20201244192	MINACU	IH12360453	MINACU	08/12/2020 20:32	10/12/2020 18:55	08/12/2020 20:32	10/12/2020 18:55	46,37	25	1159,37	CHI
20201244406	TRINDADE	TR11092502	GOYA S2	08/12/2020 20:32	08/12/2020 22:56	08/12/2020 20:32	08/12/2020 22:56	2,40	178	426,90	CHI
20201244183	MINACU	IH21353597	MINACU	08/12/2020 20:33	09/12/2020 11:05	08/12/2020 20:33	09/12/2020 11:05	14,52	1	14,52	CHI
20201244351	ITABERAI	IB12108144	ITABERAI S2	08/12/2020 20:33	09/12/2020 02:12	08/12/2020 20:33	09/12/2020 02:12	5,64	19	107,17	CHI
20201244193	BOM JARDIM DE GOIAS	1880009320	BOM JARDIM	08/12/2020 20:35	09/12/2020 07:48	08/12/2020 20:35	09/12/2020 07:48	11,22	1	11,22	CHI
20201244330	ANAPOLIS	AN11319807	JUNDIAI S2	08/12/2020 20:35	09/12/2020 01:09	08/12/2020 20:35	09/12/2020 01:09	4,56	31	141,37	CHI
20201244206	SENADOR CANEDO	SW12092633LD	SENADOR CANEDO	08/12/2020 20:36	08/12/2020 23:16	08/12/2020 20:36	08/12/2020 23:16	2,65	20	53,02	CHI
20201244244	MOSSAMEDES	MD12006197	FIRMINOPOLIS S2	08/12/2020 20:36	09/12/2020 21:45	08/12/2020 20:36	09/12/2020 21:45	25,14	24	603,43	CHI
20201239375	PORANGATU	PO12022073	PORANGATU	08/12/2020 20:38	09/12/2020 20:10	08/12/2020 20:38	09/12/2020 12:05	15,44	43	664,10	CHI
20201239375	PORANGATU	PO12088718	PORANGATU	08/12/2020 20:38	09/12/2020 20:10	08/12/2020 20:38	09/12/2020 20:10	23,53	4	94,12	CHI

20201244220	SAO LUIS DE MONTES BELOS	SL12021470	SAO LUIZ DOS MONTES BELOS	08/12/2020 20:38	09/12/2020 14:42	08/12/2020 20:38	09/12/2020 14:42	18,07	37	668,45	CHI
20201244224	TROMBAS	IH12396734	MINACU	08/12/2020 20:39	09/12/2020 10:43	08/12/2020 20:39	09/12/2020 10:43	14,07	6	84,40	CHI
20201244224	MINACU	IH12396734	MINACU	08/12/2020 20:39	09/12/2020 10:43	08/12/2020 20:39	09/12/2020 10:43	14,07	61	858,07	CHI
20201244231	MINACU	IH21230352	MINACU	08/12/2020 20:39	09/12/2020 10:30	08/12/2020 20:39	09/12/2020 10:30	13,84	1	13,84	CHI
20201244238	SANTA HELENA DE GOIAS	400055790	IPEGUARI	08/12/2020 20:40	09/12/2020 00:13	08/12/2020 20:40	09/12/2020 00:13	3,54	1	3,54	CHI
20201244282	GOIANIA	GN11247716	GOIANIA LESTE S2	08/12/2020 20:42	08/12/2020 23:31	08/12/2020 20:42	08/12/2020 23:31	2,81	77	216,58	CHI
202012179343	PIRACANJUBA	PJ21316657	ROCHEDO	08/12/2020 20:45	09/12/2020 09:56	08/12/2020 20:45	09/12/2020 09:56	13,18	1	13,18	CHI
20201244279	SANTO ANTONIO DO DESCOBERTO	SN12168727	AGUAS LINDAS DE GOIAS S2	08/12/2020 20:46	09/12/2020 02:58	08/12/2020 20:46	09/12/2020 02:58	6,19	75	464,04	CHI
20201244309	GOIANIA	GN11167610	CAMPINAS S3	08/12/2020 20:48	09/12/2020 00:09	08/12/2020 20:48	09/12/2020 00:09	3,34	106	353,69	CHI
20201245500	ITABERAÍ	IB12206931	ITABERAÍ S2	08/12/2020 20:48	09/12/2020 07:23	08/12/2020 20:48	09/12/2020 07:23	10,57	12	126,83	CHI
20201244305	GOIANIA	20790581	FERROVIARIO S3	08/12/2020 20:50	08/12/2020 23:17	08/12/2020 20:50	08/12/2020 23:17	2,45	97	237,57	CHI
20201244313	NOVA CRIXAS	NA21025132	NOVA CRIXAS	08/12/2020 20:51	09/12/2020 15:30	08/12/2020 20:51	09/12/2020 15:30	18,65	1	18,65	CHI
20201244316	GOIANIA	13618659	MEIA PONTE	08/12/2020 20:51	08/12/2020 23:20	08/12/2020 20:51	08/12/2020 23:20	2,48	1	2,48	CHI
20201244889	SANTO ANTONIO DO DESCOBERTO	SN11133138	ALEXANIA	08/12/2020 20:52	08/12/2020 23:50	08/12/2020 20:52	08/12/2020 23:50	2,96	99	293,21	CHI
20201244326	GOIANIA	10017340720	ATLANTICO S1	08/12/2020 20:53	09/12/2020 11:27	08/12/2020 20:53	09/12/2020 11:27	14,56	1	14,56	CHI
20201244422	LUZIANIA	LZ12028134	RIO VERMELHO	08/12/2020 20:53	08/12/2020 23:31	08/12/2020 20:53	08/12/2020 23:31	2,63	312	821,43	CHI
20201244331	JANDAIA	JD21301322	ACREUNA	08/12/2020 20:55	09/12/2020 20:02	08/12/2020 20:55	09/12/2020 20:02	23,11	2	46,23	CHI
20201244368	LUZIANIA	LZ21230083	MARAJOARA	08/12/2020 21:00	09/12/2020 01:17	08/12/2020 21:00	09/12/2020 01:17	4,28	1	4,28	CHI
20201244381	JATAI	JT12184056	JATAI S1	08/12/2020 21:01	09/12/2020 04:43	08/12/2020 21:01	09/12/2020 04:43	7,68	4	30,73	CHI
20201244457	CAMPESTRE DE GOIAS	CG12252073	TRINDADE	08/12/2020 21:01	09/12/2020 01:03	08/12/2020 21:01	09/12/2020 01:03	4,03	118	475,15	CHI
20201244818	ARAGOIANIA	AO12094834	GUAPO S2	08/12/2020 21:02	09/12/2020 14:14	08/12/2020 21:02	09/12/2020 14:14	17,20	12	206,39	CHI
20201244394	SAO MIGUEL DO ARAGUAIA	SM12253876	SAO MIGUEL DO ARAGUAIA	08/12/2020 21:03	09/12/2020 09:16	08/12/2020 21:03	09/12/2020 09:16	12,21	3	36,62	CHI
20201244453	GOIANIA	GN11167373	AEROPORTO S1	08/12/2020 21:03	09/12/2020 11:10	08/12/2020 21:03	09/12/2020 11:10	14,10	37	521,76	CHI
20201244486	ITAPURANGA	IK10396063	ITAPURANGA	08/12/2020 21:03	09/12/2020 12:03	08/12/2020 21:03	08/12/2020 23:03	2,00	222	444,99	CHI
20201244486	ITAPURANGA	IK10396063	ITAPURANGA	08/12/2020 21:03	09/12/2020 12:03	08/12/2020 21:03	09/12/2020 12:03	15,00	233	3495,13	CHI
20201244486	GUARAITA	IK10396063	ITAPURANGA	08/12/2020 21:03	09/12/2020 12:03	08/12/2020 21:03	09/12/2020 12:03	15,00	7	105,00	CHI
20201244486	ITAPURANGA	IK10396063	ITAPURANGA	08/12/2020 21:03	09/12/2020 12:03	08/12/2020 23:09	09/12/2020 12:03	12,90	222	2863,49	CHI
20201244404	GOIANAPOLIS	10020186345	DAIA S2	08/12/2020 21:04	09/12/2020 09:10	08/12/2020 21:04	09/12/2020 09:10	12,09	1	12,09	CHI
20201244409	JATAI	JT12105219	JATAI S1	08/12/2020 21:05	09/12/2020 01:11	08/12/2020 21:05	09/12/2020 01:11	4,09	9	36,84	CHI
20201244411	IPAMERI	IP21363869	URUTAI	08/12/2020 21:05	09/12/2020 18:25	08/12/2020 21:05	09/12/2020 18:25	21,32	1	21,32	CHI
20201244747	JUSSARA	JR12259832	BRITANIA	08/12/2020 21:06	09/12/2020 13:55	08/12/2020 21:06	09/12/2020 13:55	16,81	45	756,50	CHI
20201244747	SANTA FE DE GOIAS	JR12259832	BRITANIA	08/12/2020 21:06	09/12/2020 13:55	08/12/2020 21:06	09/12/2020 13:55	16,81	6	100,87	CHI
20201244420	SANTA TEREZINHA DE GOIAS	SG12181363	SANTA TEREZINHA	08/12/2020 21:07	09/12/2020 07:16	08/12/2020 21:07	09/12/2020 07:16	10,15	148	1502,08	CHI
20201244424	MINEIROS	10015821941	PARQUE DAS EMAS	08/12/2020 21:08	09/12/2020 07:49	08/12/2020 21:08	09/12/2020 07:49	10,68	1	10,68	CHI
20201244434	APARECIDA DE GOIANIA	10013193358	REAL S1	08/12/2020 21:09	09/12/2020 02:48	08/12/2020 21:09	09/12/2020 02:48	5,64	1	5,64	CHI
20201244439	FAZENDA NOVA	FN21220553	JUSSARA	08/12/2020 21:10	09/12/2020 21:06	08/12/2020 21:10	09/12/2020 21:06	23,93	1	23,93	CHI
20201244447	APARECIDA DE GOIANIA	10006884707	ANHANGUERA	08/12/2020 21:12	09/12/2020 00:46	08/12/2020 21:12	09/12/2020 00:46	3,56	1	3,56	CHI
20201245121	IPORA	IR12091436	IPORA	08/12/2020 21:12	09/12/2020 07:07	08/12/2020 21:12	09/12/2020 07:07	9,91	16	158,63	CHI
20201245121	AMORINOPOLIS	IR12091436	IPORA	08/12/2020 21:12	09/12/2020 07:07	08/12/2020 21:12	09/12/2020 07:07	9,91	3	29,74	CHI
20201246804	RIO VERDE	RV21384676	CABRIUVA S2	08/12/2020 21:12	09/12/2020 18:14	08/12/2020 21:12	09/12/2020 18:14	21,02	1	21,02	CHI
20201244465	NOVA CRIXAS	NA21291227	NOVA CRIXAS	08/12/2020 21:13	09/12/2020 09:38	08/12/2020 21:13	09/12/2020 09:38	12,40	1	12,40	CHI
20201244469	BURITI DE GOIAS	1680013080	FIRMINOPOLIS S2	08/12/2020 21:14	10/12/2020 10:45	08/12/2020 21:14	10/12/2020 10:45	37,50	1	37,50	CHI
20201244514	SENADOR CANEDO	SW11160821	SENADOR CANEDO	08/12/2020 21:14	08/12/2020 23:03	08/12/2020 21:14	08/12/2020 23:03	1,80	116	208,90	CHI
20201244472	PANAMA	PX21190960	CACHOEIRA DOURADA	08/12/2020 21:15	09/12/2020 12:41	08/12/2020 21:15	09/12/2020 12:41	15,43	2	30,86	CHI
20201244520	APARECIDA DE GOIANIA	AP11391739	INDEPENDENCIA S2	08/12/2020 21:15	09/12/2020 09:48	08/12/2020 21:15	09/12/2020 09:48	12,54	77	965,73	CHI
20201244921	ITAPIRAPUA	IU12073717	MATRINCHA	08/12/2020 21:16	09/12/2020 10:09	08/12/2020 21:16	09/12/2020 10:09	12,87	10	128,72	CHI
20201244921	GOIAS	IU12073717	MATRINCHA	08/12/2020 21:16	09/12/2020 10:09	08/12/2020 21:16	09/12/2020 10:09	12,87	12	154,47	CHI
20201245973	GOIANESIA	GE12327807	GOIANESIA S2	08/12/2020 21:16	09/12/2020 10:16	08/12/2020 21:16	09/12/2020 10:16	13,00	42	545,89	CHI
20201244489	ALTO PARAISO DE GOIAS	BF12244573	SAO JOAO D ALIANCA	08/12/2020 21:17	09/12/2020 14:53	08/12/2020 21:17	09/12/2020 14:53	17,60	1	17,60	CHI
20201244749	PIRES DO RIO	PZ12114941	PIRES DO RIO S2	08/12/2020 21:17	10/12/2020 18:02	08/12/2020 21:17	10/12/2020 18:02	44,75	3	134,24	CHI
20201244749	SANTA CRUZ DE GOIAS	PZ12114941	PIRES DO RIO S2	08/12/2020 21:17	10/12/2020 18:02	08/12/2020 21:17	10/12/2020 18:02	44,75	31	1387,16	CHI

20201244754	EDEIA	EA12257973	EDEIA	08/12/2020 21:17	09/12/2020 22:19	08/12/2020 21:17	09/12/2020 22:19	25,05	33	826,49	CHI
20201244754	ACREUNA	EA12257973	EDEIA	08/12/2020 21:17	09/12/2020 22:19	08/12/2020 21:17	09/12/2020 22:19	25,05	13	325,59	CHI
20201244754	INDIARA	EA12257973	EDEIA	08/12/2020 21:17	09/12/2020 22:19	08/12/2020 21:17	09/12/2020 22:19	25,05	7	175,32	CHI
20201244499	CRISTALINA	KR11032628	PAMPLONA	08/12/2020 21:18	10/12/2020 00:01	08/12/2020 21:18	10/12/2020 00:01	26,71	81	2163,56	CHI
20201244503	JARAGUA	JA12059971	JARAGUA	08/12/2020 21:18	08/12/2020 23:52	08/12/2020 21:18	08/12/2020 23:52	2,55	10	25,54	CHI
20201245651	CASTELANDIA	RV12026916	RIO DOS BOIS	08/12/2020 21:18	09/12/2020 11:56	08/12/2020 21:18	09/12/2020 11:56	14,63	12	175,51	CHI
20201245651	RIO VERDE	RV12026916	RIO DOS BOIS	08/12/2020 21:18	09/12/2020 11:56	08/12/2020 21:18	09/12/2020 11:56	14,63	2	29,25	CHI
20201244522	JATAI	JT12303380RE	JATAI S1	08/12/2020 21:19	09/12/2020 08:05	08/12/2020 21:19	09/12/2020 08:05	10,75	26	279,51	CHI
20201244626	APARECIDA DE GOIANIA	AP16401558	ANHANGUERA	08/12/2020 21:20	08/12/2020 21:59	08/12/2020 21:20	08/12/2020 21:31	0,18	1632	286,51	CHI
20201244626	APARECIDA DE GOIANIA	AP16401559	ANHANGUERA	08/12/2020 21:20	08/12/2020 21:59	08/12/2020 21:20	08/12/2020 21:31	0,18	90	16,45	CHI
20201244626	APARECIDA DE GOIANIA	AP16401559	ANHANGUERA	08/12/2020 21:20	08/12/2020 21:59	08/12/2020 21:20	08/12/2020 21:32	0,19	979	188,73	CHI
20201244626	APARECIDA DE GOIANIA	AP16401559	ANHANGUERA	08/12/2020 21:20	08/12/2020 21:59	08/12/2020 21:20	08/12/2020 21:33	0,20	282	57,18	CHI
20201244626	APARECIDA DE GOIANIA	AP16401557	ANHANGUERA	08/12/2020 21:20	08/12/2020 21:59	08/12/2020 21:20	08/12/2020 21:59	0,64	1603	1031,71	CHI
20201244551	APARECIDA DE GOIANIA	AP11376806	ANHANGUERA	08/12/2020 21:20	08/12/2020 22:58	08/12/2020 21:20	08/12/2020 22:58	1,62	199	321,77	CHI
20201244541	COCALZINHO DE GOIAS	1200006668	COCALZINHO	08/12/2020 21:24	09/12/2020 15:27	08/12/2020 21:24	09/12/2020 15:27	18,05	1	18,05	CHI
20201244546	ANAPOLIS	20113341	ANAPOLIS UNIVERSITARIO S2	08/12/2020 21:25	09/12/2020 05:06	08/12/2020 21:25	09/12/2020 05:06	7,68	1	7,68	CHI
20201244547	LUZIANIA	3200007641	MARAJOARA	08/12/2020 21:25	09/12/2020 11:51	08/12/2020 21:25	09/12/2020 11:51	14,43	1	14,43	CHI
20201244548	BONFINOPOLIS	BO11000008	CEPAIGO S2	08/12/2020 21:25	08/12/2020 23:51	08/12/2020 21:25	08/12/2020 23:51	2,43	186	451,82	CHI
20201244564	GOIANIA	SW21079091	GOIANIA LESTE S2	08/12/2020 21:27	09/12/2020 01:54	08/12/2020 21:27	09/12/2020 01:54	4,45	1	4,45	CHI
20201244581	ARAGOIANIA	AO21000101	GUAPO S2	08/12/2020 21:28	08/12/2020 22:43	08/12/2020 21:28	08/12/2020 22:43	1,24	1	1,24	CHI
20201245444	VILA PROPICIO	NP12327893LD	GOIANESIA S1	08/12/2020 21:30	09/12/2020 11:43	08/12/2020 21:30	09/12/2020 11:43	14,21	97	1378,48	CHI
20201244598	PIRES DO RIO	PR12202879	PIRES DO RIO S1	08/12/2020 21:31	09/12/2020 11:45	08/12/2020 21:31	09/12/2020 11:45	14,23	28	398,46	CHI
20201244601	PILAR DE GOIAS	GG12214544	URUACU	08/12/2020 21:31	08/12/2020 23:34	08/12/2020 21:31	08/12/2020 23:34	2,04	1	2,04	CHI
20201244630	CIDADE OCIDENTAL	2680151982	MARAJOARA	08/12/2020 21:35	09/12/2020 10:59	08/12/2020 21:35	09/12/2020 10:59	13,39	1	13,39	CHI
20201245688	ITUMBARA	IT12033049	BOM JESUS DE GOIAS	08/12/2020 21:37	09/12/2020 11:32	08/12/2020 21:37	09/12/2020 11:32	13,91	7	97,39	CHI
20201245091	SAO LUIS DE MONTES BELOS	SL12125616	FIRMINOPOLIS S1	08/12/2020 21:38	09/12/2020 08:28	08/12/2020 21:38	09/12/2020 08:28	10,82	10	108,22	CHI
20201244821	ANAPOLIS	AN11096679	JUNDIAI S2	08/12/2020 21:39	09/12/2020 03:27	08/12/2020 21:39	09/12/2020 03:27	5,80	102	591,46	CHI
20201244652	ARAGOIANIA	HD12000067	INDEPENDENCIA S1	08/12/2020 21:40	09/12/2020 10:40	08/12/2020 21:40	09/12/2020 10:40	13,00	5	64,98	CHI
20201244652	HIDROLANDIA	HD12000067	INDEPENDENCIA S1	08/12/2020 21:40	09/12/2020 10:40	08/12/2020 21:40	09/12/2020 10:40	13,00	11	142,96	CHI
20201244707	HIDROLANDIA	HD11006283	ANHANGUERA	08/12/2020 21:40	09/12/2020 00:38	08/12/2020 21:40	09/12/2020 00:38	2,97	129	382,56	CHI
20201246141	FORMOSA	FA12383272	ITUIQUIRA	08/12/2020 21:42	09/12/2020 18:00	08/12/2020 21:42	09/12/2020 18:00	20,29	39	791,42	CHI
20201244763	GOIANIA	GN11163701	CARAIAS S1	08/12/2020 21:44	09/12/2020 02:15	08/12/2020 21:44	09/12/2020 02:15	4,50	141	634,97	CHI
20201244697	LUZIANIA	LZ12237865	MARAJOARA	08/12/2020 21:46	09/12/2020 03:21	08/12/2020 21:46	09/12/2020 03:21	5,58	48	267,93	CHI
20201244703	LUZIANIA	120041224	RIO VERMELHO	08/12/2020 21:47	09/12/2020 03:13	08/12/2020 21:47	09/12/2020 03:13	5,42	1	5,42	CHI
20201244706	ITAPIRAPUA	IU21142813	MATRINCHA	08/12/2020 21:48	09/12/2020 12:02	08/12/2020 21:48	09/12/2020 12:02	14,23	1	14,23	CHI
20201244711	ORIZONA	OZ11272878	PIRES DO RIO S2	08/12/2020 21:49	09/12/2020 19:08	08/12/2020 21:49	09/12/2020 19:08	21,31	89	1896,52	CHI
20201244713	CIDADE OCIDENTAL	DH21183851	MARAJOARA	08/12/2020 21:49	09/12/2020 11:56	08/12/2020 21:49	09/12/2020 11:56	14,11	1	14,11	CHI
20201244717	GOIANIA	GN11162059	CAMPINAS S3	08/12/2020 21:49	09/12/2020 09:57	08/12/2020 21:49	09/12/2020 09:57	12,12	27	327,22	CHI
20201244720	MONTES CLAROS DE GOIAS	ME12004038	IPORA	08/12/2020 21:50	09/12/2020 17:45	08/12/2020 21:50	09/12/2020 17:45	19,91	1	19,91	CHI
20201244725	GOIANESIA	GE12080429	GOIANESIA S1	08/12/2020 21:51	09/12/2020 00:31	08/12/2020 21:51	09/12/2020 00:31	2,66	13	34,53	CHI
20201244727	MONTIVIDIU	MV21144681	MONTIVIDIU T	08/12/2020 21:52	09/12/2020 04:02	08/12/2020 21:52	09/12/2020 04:02	6,16	1	6,16	CHI
20201244915	AMORINOPOLIS	AM12040176	IPORA	08/12/2020 21:52	09/12/2020 13:20	08/12/2020 21:52	09/12/2020 13:20	15,46	12	185,48	CHI
20201244915	IPORA	AM12040176	IPORA	08/12/2020 21:52	09/12/2020 13:20	08/12/2020 21:52	09/12/2020 13:20	15,46	6	92,74	CHI
20201245559	BALIZA	BH12343730	BOM JARDIM	08/12/2020 21:54	09/12/2020 08:32	08/12/2020 21:54	09/12/2020 08:32	10,63	9	95,66	CHI
20201245943	GOIATUBA	6955126	BOM JESUS DE GOIAS	08/12/2020 21:54	09/12/2020 10:17	08/12/2020 21:54	09/12/2020 10:17	12,37	3	37,12	CHI
20201245943	BOM JESUS DE GOIAS	6955126	BOM JESUS DE GOIAS	08/12/2020 21:54	09/12/2020 10:17	08/12/2020 21:54	09/12/2020 10:17	12,37	2	24,75	CHI
20201244750	GOIANIA	11006110	FERROVIARIO S2	08/12/2020 21:58	09/12/2020 02:06	08/12/2020 21:58	09/12/2020 02:06	4,13	1	4,13	CHI
20201244806	VILA BOA	FA12218264	ITUIQUIRA	08/12/2020 21:58	09/12/2020 07:28	08/12/2020 21:58	09/12/2020 07:28	9,49	4	37,95	CHI
20201244806	FORMOSA	FA12218264	ITUIQUIRA	08/12/2020 21:58	09/12/2020 07:28	08/12/2020 21:58	09/12/2020 07:28	9,49	92	872,93	CHI
20201245481	CACU	BX12168258	SAO MIGUEL DO ARAGUAIA	08/12/2020 21:58	09/12/2020 13:08	08/12/2020 21:58	09/12/2020 13:08	15,15	1	15,15	CHI
20201245481	BONOPOLIS	BX12168258	SAO MIGUEL DO ARAGUAIA	08/12/2020 21:58	09/12/2020 13:08	08/12/2020 21:58	09/12/2020 13:08	15,15	20	303,07	CHI

20201244764	ITABERAÍ	50054168	ITABERAÍ S2	08/12/2020 22:01	09/12/2020 00:35	08/12/2020 22:01	09/12/2020 00:35	2,55	1	2,55	CHI
20201244768	CALDAZINHA	BV21340069	CEPAIGO S2	08/12/2020 22:03	09/12/2020 00:01	08/12/2020 22:03	09/12/2020 00:01	1,96	12	23,58	CHI
20201244770	SANTA BARBARA DE GOIAS	SB21216885	TRINDADE	08/12/2020 22:04	09/12/2020 02:53	08/12/2020 22:04	09/12/2020 02:53	4,81	1	4,81	CHI
20201244780	PIRENOPOLIS	PV12302141	SAO FRANCISCO DE GOIAS	08/12/2020 22:06	09/12/2020 09:14	08/12/2020 22:06	09/12/2020 09:14	11,12	95	1056,35	CHI
20201244798	PIRACANJUBA	PJ13200328	ROCHEDO	08/12/2020 22:06	09/12/2020 16:15	08/12/2020 22:06	09/12/2020 09:56	11,83	38	449,43	CHI
20201244798	PROFESSOR JAMIL SAFADY	PJ13200328	ROCHEDO	08/12/2020 22:06	09/12/2020 16:15	08/12/2020 22:06	09/12/2020 09:56	11,83	81	958,01	CHI
20201244798	HIDROLANDIA	PJ13200328	ROCHEDO	08/12/2020 22:06	09/12/2020 16:15	08/12/2020 22:06	09/12/2020 09:56	11,83	9	106,45	CHI
20201244798	CROMINIA	PJ13200328	ROCHEDO	08/12/2020 22:06	09/12/2020 16:15	08/12/2020 22:06	09/12/2020 09:56	11,83	4	47,31	CHI
20201244798	PIRACANJUBA	JS10406682	ROCHEDO	08/12/2020 22:06	09/12/2020 16:15	08/12/2020 22:06	09/12/2020 11:22	13,26	188	2492,51	CHI
20201244798	PROFESSOR JAMIL SAFADY	JS10406682	ROCHEDO	08/12/2020 22:06	09/12/2020 16:15	08/12/2020 22:06	09/12/2020 11:22	13,26	26	344,71	CHI
20201244798	PROFESSOR JAMIL SAFADY	JS10406682	ROCHEDO	08/12/2020 22:06	09/12/2020 16:15	08/12/2020 22:06	09/12/2020 16:15	18,14	62	1124,49	CHI
20201244798	PIRACANJUBA	JS10406682	ROCHEDO	08/12/2020 22:06	09/12/2020 16:15	08/12/2020 22:06	09/12/2020 16:15	18,14	60	1088,22	CHI
20201244781	GOIANIA	13069846	GOYA S1	08/12/2020 22:07	09/12/2020 11:14	08/12/2020 22:07	09/12/2020 11:14	13,11	1	13,11	CHI
20201245087	GOIANIA	GN12220945	GOYA S2	08/12/2020 22:09	09/12/2020 02:47	08/12/2020 22:09	09/12/2020 02:47	4,63	321	1484,63	CHI
20201244803	ITUMBIARA	IT12257023RE	ITUMBIARA NOVA	08/12/2020 22:13	09/12/2020 00:13	08/12/2020 22:13	09/12/2020 00:13	2,00	67	133,68	CHI
20201244809	IPORA	730107802	IPORA	08/12/2020 22:14	09/12/2020 17:15	08/12/2020 22:14	09/12/2020 17:15	19,02	1	19,02	CHI
20201245006	EDEIA	EA12394167	EDEIA	08/12/2020 22:16	09/12/2020 05:40	08/12/2020 22:16	09/12/2020 05:40	7,39	6	44,34	CHI
20201244824	MINEIROS	MY12325793	PARQUE DAS EMAS	08/12/2020 22:20	09/12/2020 18:57	08/12/2020 22:20	09/12/2020 18:57	20,61	3	61,84	CHI
20201244825	BELA VISTA DE GOIAS	BV12035058	BELA VISTA S1	08/12/2020 22:20	09/12/2020 04:19	08/12/2020 22:20	09/12/2020 04:19	5,97	6	35,85	CHI
20201244826	SANTA HELENA DE GOIAS	SH21301724	ACREUNA	08/12/2020 22:20	09/12/2020 04:34	08/12/2020 22:20	09/12/2020 04:34	6,22	4	24,88	CHI
20201244830	GOIANESIA	GE21120472	GOIANESIA S1	08/12/2020 22:22	09/12/2020 13:50	08/12/2020 22:22	09/12/2020 13:50	15,46	1	15,46	CHI
20201244838	LUZIANIA	120230732	RIO VERMELHO	08/12/2020 22:24	09/12/2020 01:42	08/12/2020 22:24	09/12/2020 01:42	3,29	1	3,29	CHI
20201245580	MOSSAMEDES	SC12003889	FIRMINOPOLIS S2	08/12/2020 22:25	09/12/2020 07:23	08/12/2020 22:25	09/12/2020 07:23	8,96	5	44,80	CHI
20201245580	ADELANDIA	SC12003889	FIRMINOPOLIS S2	08/12/2020 22:25	09/12/2020 07:23	08/12/2020 22:25	09/12/2020 07:23	8,96	24	215,05	CHI
20201245580	SANCLERLANDIA	SC12003889	FIRMINOPOLIS S2	08/12/2020 22:25	09/12/2020 07:23	08/12/2020 22:25	09/12/2020 07:23	8,96	16	143,37	CHI
20201244897	SAO MIGUEL DO ARAGUAIA	SM12292369	SAO MIGUEL DO ARAGUAIA	08/12/2020 22:27	09/12/2020 08:16	08/12/2020 22:27	09/12/2020 08:16	9,81	75	735,65	CHI
20201245393	SANTA RITA DO NOVO DESTINO	BA12152774	BARRO ALTO	08/12/2020 22:27	09/12/2020 13:59	08/12/2020 22:27	09/12/2020 13:59	15,53	71	1102,43	CHI
20201244879	ANAPOLIS	AN10384922	DAIA S1	08/12/2020 22:29	09/12/2020 04:40	08/12/2020 22:29	08/12/2020 23:41	1,21	39	47,22	CHI
20201244879	ANAPOLIS	AN13382481	DAIA S1	08/12/2020 22:29	09/12/2020 04:40	08/12/2020 22:29	09/12/2020 02:42	4,22	14	59,08	CHI
20201244879	LEOPOLDO DE BULHOES	AN13382481	DAIA S1	08/12/2020 22:29	09/12/2020 04:40	08/12/2020 22:29	09/12/2020 02:42	4,22	33	139,27	CHI
20201244879	SILVANIA	LB12057538	DAIA S1	08/12/2020 22:29	09/12/2020 04:40	08/12/2020 22:29	09/12/2020 03:50	5,35	24	128,41	CHI
20201244879	LEOPOLDO DE BULHOES	LB12057538	DAIA S1	08/12/2020 22:29	09/12/2020 04:40	08/12/2020 22:29	09/12/2020 03:50	5,35	11	58,85	CHI
20201244879	LEOPOLDO DE BULHOES	LB12000624	DAIA S1	08/12/2020 22:29	09/12/2020 04:40	08/12/2020 22:29	09/12/2020 04:40	6,18	33	204,06	CHI
20201244883	PORANGATU	PO10398416	PORANGATU	08/12/2020 22:29	09/12/2020 02:34	08/12/2020 22:29	08/12/2020 23:30	1,02	644	655,09	CHI
20201244883	PORANGATU	PO13220580	PORANGATU	08/12/2020 22:29	09/12/2020 02:34	08/12/2020 22:29	09/12/2020 00:58	2,48	86	213,40	CHI
20201244883	PORANGATU	PO13360150	PORANGATU	08/12/2020 22:29	09/12/2020 02:34	08/12/2020 22:29	09/12/2020 01:48	3,31	108	357,15	CHI
20201244883	PORANGATU	PO13286012	PORANGATU	08/12/2020 22:29	09/12/2020 02:34	08/12/2020 22:29	09/12/2020 02:34	4,08	4	16,33	CHI
20201245780	APORE	AE18122767TS	ITAJA S1	08/12/2020 22:30	09/12/2020 09:34	08/12/2020 22:30	09/12/2020 09:34	11,07	29	320,90	CHI
20201244925	PORANGATU	PO12141125	NOVO PLANALTO	08/12/2020 22:32	09/12/2020 16:12	08/12/2020 22:32	09/12/2020 13:54	15,37	8	123,00	CHI
20201244925	PORANGATU	PO12141125	NOVO PLANALTO	08/12/2020 22:32	09/12/2020 16:12	08/12/2020 22:32	09/12/2020 16:12	17,68	5	88,40	CHI
20201245572	ALTO HORIZONTE	AJ12213250LD	SANTA TEREZINHA	08/12/2020 22:34	09/12/2020 12:23	08/12/2020 22:34	09/12/2020 12:23	13,81	55	759,38	CHI
20201244886	SENADOR CANEDO	SW11247951	SENADOR CANEDO	08/12/2020 22:37	09/12/2020 01:46	08/12/2020 22:37	09/12/2020 01:46	3,15	115	362,76	CHI
20201244888	SANTA HELENA DE GOIAS	SH21249051	ACREUNA	08/12/2020 22:38	09/12/2020 02:37	08/12/2020 22:38	09/12/2020 02:37	3,98	1	3,98	CHI
20201246324	GOIATUBA	JV12223260	GOIATUBA S1	08/12/2020 22:40	09/12/2020 17:13	08/12/2020 22:40	09/12/2020 17:13	18,55	10	185,49	CHI
20201244894	POSSE	PS12143770	IACIARA S2	08/12/2020 22:41	09/12/2020 01:21	08/12/2020 22:41	09/12/2020 01:21	2,65	112	297,14	CHI
20201244895	FORMOSA	FA12404372	ITUIQUARA	08/12/2020 22:42	09/12/2020 08:11	08/12/2020 22:42	09/12/2020 08:11	9,47	166	1572,85	CHI
20201244918	SANTA RITA DO NOVO DESTINO	DF12194371	BARRO ALTO	08/12/2020 22:44	09/12/2020 01:57	08/12/2020 22:44	09/12/2020 01:57	3,22	32	102,88	CHI
20201244918	BARRO ALTO	DF12194371	BARRO ALTO	08/12/2020 22:44	09/12/2020 01:57	08/12/2020 22:44	09/12/2020 01:57	3,22	67	215,41	CHI
20201244907	LUZIANIA	LZ21209588	MARAJOARA	08/12/2020 22:46	09/12/2020 01:51	08/12/2020 22:46	09/12/2020 01:51	3,08	1	3,08	CHI
20201244914	JATAI	JT12264398	JATAI S1	08/12/2020 22:49	10/12/2020 04:29	08/12/2020 22:49	10/12/2020 04:29	29,66	2	59,32	CHI
20201246628	MONTES CLAROS DE GOIAS	DI12231269	ARENOPOLIS	08/12/2020 22:49	09/12/2020 09:44	08/12/2020 22:49	09/12/2020 09:44	10,90	32	348,86	CHI

20201246628	DIORAMA	DI12231269	ARENOPOLIS	08/12/2020 22:49	09/12/2020 09:44	08/12/2020 22:49	09/12/2020 09:44	10,90	90	981,18	CHI
20201246197	PADRE BERNARDO	PB12382215	PADRE BERNARDO	08/12/2020 22:55	09/12/2020 10:25	08/12/2020 22:55	09/12/2020 10:25	11,49	15	172,38	CHI
20201244931	SANTA RITA DO ARAGUAIA	SU21365147	SANTA RITA DO ARAGUAIA	08/12/2020 22:56	09/12/2020 08:27	08/12/2020 22:56	09/12/2020 08:27	9,50	1	9,50	CHI
20201244933	GOIANIA	GN11151331	GOIANIA LESTE S3	08/12/2020 22:57	09/12/2020 01:48	08/12/2020 22:57	09/12/2020 01:48	2,83	3	8,50	CHI
20201246340	GOIATUBA	GT12000148RE	GOIATUBA S1	08/12/2020 22:58	09/12/2020 09:45	08/12/2020 22:58	09/12/2020 09:45	10,77	13	140,02	CHI
20201246340	PANAMA	GT12000148RE	GOIATUBA S1	08/12/2020 22:58	09/12/2020 09:45	08/12/2020 22:58	09/12/2020 09:45	10,77	78	840,10	CHI
20201244961	APARECIDA DE GOIANIA	AP11166682	ANHANGUERA	08/12/2020 22:59	09/12/2020 10:23	08/12/2020 22:59	09/12/2020 10:23	11,39	190	2164,31	CHI
20201244938	LUZIANIA	120024822	RIO VERMELHO	08/12/2020 23:00	09/12/2020 11:54	08/12/2020 23:00	09/12/2020 11:54	12,89	1	12,89	CHI
20201245956	URUACU	MQ12181177	MARA ROSA	08/12/2020 23:01	09/12/2020 18:48	08/12/2020 23:01	09/12/2020 18:48	19,77	1	19,77	CHI
20201245956	MARA ROSA	MQ12181177	MARA ROSA	08/12/2020 23:01	09/12/2020 18:48	08/12/2020 23:01	09/12/2020 18:48	19,77	28	553,54	CHI
20201245956	ALTO HORIZONTE	MQ12181177	MARA ROSA	08/12/2020 23:01	09/12/2020 18:48	08/12/2020 23:01	09/12/2020 18:48	19,77	3	59,31	CHI
20201244948	GOIANIA	GN11135074	CAMPINAS S1	08/12/2020 23:04	09/12/2020 09:57	08/12/2020 23:04	09/12/2020 09:57	10,87	87	945,88	CHI
20201245036	MORRINHOS	MR12000278	MORRINHOS	08/12/2020 23:04	09/12/2020 09:06	08/12/2020 23:04	09/12/2020 09:06	10,03	53	531,59	CHI
20201245664	INDIARA	IY12233476	EDEIA	08/12/2020 23:04	09/12/2020 17:06	08/12/2020 23:04	09/12/2020 17:06	18,02	39	702,86	CHI
20201244952	CALDAS NOVAS	CN12246629	SERRA DE CALDAS	08/12/2020 23:06	09/12/2020 03:09	08/12/2020 23:06	09/12/2020 03:09	4,04	35	141,57	CHI
20201244955	ITAGUARU	IC12353099RE	ITABERAI S1	08/12/2020 23:07	09/12/2020 07:24	08/12/2020 23:07	09/12/2020 07:24	8,27	70	579,15	CHI
20201244955	URUANA	IC12353099RE	ITABERAI S1	08/12/2020 23:07	09/12/2020 07:24	08/12/2020 23:07	09/12/2020 07:24	8,27	10	82,74	CHI
20201245093	FORMOSA	FA12254301	ITUIQUIRA	08/12/2020 23:07	09/12/2020 13:28	08/12/2020 23:07	09/12/2020 13:28	14,35	8	114,76	CHI
20201245275	ORIZONA	OZ12015050	VIANOPOLIS	08/12/2020 23:08	09/12/2020 22:03	08/12/2020 23:08	09/12/2020 22:03	22,92	12	275,02	CHI
20201246469	CIDADE OCIDENTAL	DH12353958	MARAJOARA	08/12/2020 23:08	09/12/2020 12:16	08/12/2020 23:08	09/12/2020 12:16	13,13	59	774,82	CHI
20201246469	VALPARAISO DE GOIAS	DH12353958	MARAJOARA	08/12/2020 23:08	09/12/2020 12:16	08/12/2020 23:08	09/12/2020 12:16	13,13	114	1497,11	CHI
20201247220	PIRACANJUBA	PJ12000083	PIRACANJUBA	08/12/2020 23:11	10/12/2020 09:16	08/12/2020 23:11	10/12/2020 09:16	34,08	57	1942,72	CHI
20201245063	CALDAS NOVAS	CN12246620	SERRA DE CALDAS	08/12/2020 23:17	09/12/2020 01:55	08/12/2020 23:17	09/12/2020 01:55	2,63	922	2420,25	CHI
20201245003	PIRES DO RIO	PR12000074	PIRES DO RIO S1	08/12/2020 23:24	09/12/2020 08:37	08/12/2020 23:24	09/12/2020 08:37	9,20	6	55,23	CHI
20201245035	CALDAS NOVAS	CN11103821	SERRA DE CALDAS	08/12/2020 23:24	09/12/2020 04:35	08/12/2020 23:24	09/12/2020 04:35	5,17	215	1111,67	CHI
20201245341	ANICUNS	TV12005709	FIRMINOPOLIS S2	08/12/2020 23:24	09/12/2020 09:13	08/12/2020 23:24	09/12/2020 09:13	9,81	18	176,63	CHI
20201245021	SAO MIGUEL DO ARAGUAIA	SM10371101	SAO MIGUEL DO ARAGUAIA	08/12/2020 23:26	08/12/2020 23:29	08/12/2020 23:26	08/12/2020 23:29	0,06	253	15,67	CHI
20201245606	RIO QUENTE	RQ12153452	RIO QUENTE	08/12/2020 23:27	09/12/2020 08:18	08/12/2020 23:27	09/12/2020 08:18	8,84	269	2377,89	CHI
20201245017	ANICUNS	910010122	ANICUNS	08/12/2020 23:28	09/12/2020 07:54	08/12/2020 23:28	09/12/2020 07:54	8,43	1	8,43	CHI
20201245018	NAZARIO	NZ21076353	ANICUNS	08/12/2020 23:28	09/12/2020 13:46	08/12/2020 23:28	09/12/2020 13:46	14,29	4	57,17	CHI
20201245024	JATAI	290079690	JATAI S3	08/12/2020 23:31	09/12/2020 18:18	08/12/2020 23:31	09/12/2020 18:18	18,78	1	18,78	CHI
20201245026	RIO QUENTE	RQ12316156	VILA CORUMBA	08/12/2020 23:31	09/12/2020 10:48	08/12/2020 23:31	09/12/2020 10:48	11,28	2	22,56	CHI
20201245049	GOIANIA	GN12319334	GOYA S2	08/12/2020 23:31	09/12/2020 02:46	08/12/2020 23:31	09/12/2020 02:46	3,25	389	1263,39	CHI
20201245034	PIRENOPOLIS	PV21258311	CORUMBA	08/12/2020 23:34	09/12/2020 00:26	08/12/2020 23:34	09/12/2020 00:26	0,85	3	2,56	CHI
20201245039	ABADIA DE GOIAS	5583358808	CARAJAS S1	08/12/2020 23:37	09/12/2020 00:38	08/12/2020 23:37	09/12/2020 00:38	1,00	1	1,00	CHI
20201245991	RIO QUENTE	RQ12100189	RIO QUENTE	08/12/2020 23:40	09/12/2020 08:50	08/12/2020 23:40	09/12/2020 08:50	9,15	80	732,09	CHI
20201245991	CALDAS NOVAS	RQ12100189	RIO QUENTE	08/12/2020 23:40	09/12/2020 08:50	08/12/2020 23:40	09/12/2020 08:50	9,15	8	73,21	CHI
20201245649	PIRACANJUBA	PJ12040800	PIRACANJUBA	08/12/2020 23:41	10/12/2020 09:57	08/12/2020 23:41	10/12/2020 09:57	34,26	41	1404,64	CHI
20201245047	CALDAS NOVAS	760374661	SERRA DE CALDAS	08/12/2020 23:42	09/12/2020 14:06	08/12/2020 23:42	09/12/2020 14:06	14,40	1	14,40	CHI
20201245158	CALDAS NOVAS	CN11160320	SERRA DE CALDAS	08/12/2020 23:46	09/12/2020 04:39	08/12/2020 23:46	09/12/2020 04:39	4,89	200	977,72	CHI
20201247192	ANAPOLIS	PV12024149	CORUMBA	08/12/2020 23:47	09/12/2020 21:44	08/12/2020 23:47	09/12/2020 21:44	21,95	1	21,95	CHI
20201247192	PIRENOPOLIS	PV12024149	CORUMBA	08/12/2020 23:47	09/12/2020 21:44	08/12/2020 23:47	09/12/2020 21:44	21,95	23	504,74	CHI
20201245074	PORANGATU	PO21372646	PORANGATU	08/12/2020 23:49	09/12/2020 04:08	08/12/2020 23:49	09/12/2020 04:08	4,31	1	4,31	CHI
20201245108	PIRACANJUBA	PJ12378318	PIRACANJUBA	08/12/2020 23:51	09/12/2020 07:18	08/12/2020 23:51	09/12/2020 07:18	7,44	311	2312,80	CHI
20201245078	BOM JARDIM DE GOIAS	BM12316457	BOM JARDIM	08/12/2020 23:53	09/12/2020 09:40	08/12/2020 23:53	09/12/2020 09:40	9,78	4	39,13	CHI
20201245078	ARAGARCAS	BM12316457	BOM JARDIM	08/12/2020 23:53	09/12/2020 09:40	08/12/2020 23:53	09/12/2020 09:40	9,78	2	19,57	CHI
20201245085	JATAI	290044911	JATAI S3	08/12/2020 23:57	09/12/2020 17:50	08/12/2020 23:57	09/12/2020 17:50	17,88	1	17,88	CHI
20201245625	CALDAS NOVAS	CN12248167	SERRA DE CALDAS	08/12/2020 23:59	09/12/2020 09:07	08/12/2020 23:59	09/12/2020 09:07	9,13	97	885,58	CHI
20201245096	VIANOPOLIS	10002811292	VIANOPOLIS	09/12/2020 00:08	09/12/2020 12:11	09/12/2020 00:08	09/12/2020 12:11	12,05	1	12,05	CHI
20201246227	ANAPOLIS	AN11000513	ANAPOLIS UNIVERSITARIO S1	09/12/2020 00:08	09/12/2020 08:26	09/12/2020 00:08	09/12/2020 08:26	8,29	130	1078,17	CHI
20201245109	GOIANDIRA	CT21266361	CATALAO S1	09/12/2020 00:14	09/12/2020 02:05	09/12/2020 00:14	09/12/2020 02:05	1,84	1	1,84	CHI

20201246303	CALDAS NOVAS	CN12213980	SERRA DE CALDAS	09/12/2020 00:32	09/12/2020 08:21	09/12/2020 00:32	09/12/2020 08:21	7,81	265	2070,46	CHI
20201245122	ANAPOLIS	10010419053	ANAPOLIS UNIVERSITARIO S2	09/12/2020 00:35	09/12/2020 18:26	09/12/2020 00:35	09/12/2020 18:26	17,85	1	17,85	CHI
20201246743	PONTALINA	PK21151623	PONTALINA	09/12/2020 00:45	09/12/2020 11:54	09/12/2020 00:45	09/12/2020 11:54	11,14	2	22,27	CHI
20201245130	CRISTALINA	KR12163676RE	PAMPLONA	09/12/2020 00:46	09/12/2020 09:44	09/12/2020 00:46	09/12/2020 09:44	8,96	3	26,87	CHI
20201245134	GOIANESIA	GE12000241	GOIANESIA S2	09/12/2020 00:53	09/12/2020 09:03	09/12/2020 00:53	09/12/2020 09:03	8,17	2	16,33	CHI
20201245134	JARAGUA	GE12000241	GOIANESIA S2	09/12/2020 00:53	09/12/2020 09:03	09/12/2020 00:53	09/12/2020 09:03	8,17	23	187,80	CHI
20201245794	MINEIROS	MY12374334	PARQUE DAS EMAS	09/12/2020 00:58	09/12/2020 08:26	09/12/2020 00:58	09/12/2020 08:26	7,46	7	52,21	CHI
20201246359	CALDAS NOVAS	CN12000065	SERRA DE CALDAS	09/12/2020 00:58	09/12/2020 10:27	09/12/2020 00:58	09/12/2020 10:27	9,47	162	1534,32	CHI
20201245144	PILAR DE GOIAS	IW12170008	ITAPACI	09/12/2020 01:05	09/12/2020 11:59	09/12/2020 01:05	09/12/2020 11:59	10,90	3	32,70	CHI
20201245144	ITAPACI	IW12170008	ITAPACI	09/12/2020 01:05	09/12/2020 11:59	09/12/2020 01:05	09/12/2020 11:59	10,90	5	54,50	CHI
20201245148	APARECIDA DE GOIANIA	10018563846	INDEPENDENCIA S2	09/12/2020 01:11	09/12/2020 05:29	09/12/2020 01:11	09/12/2020 05:29	4,30	1	4,30	CHI
20201246171	MINEIROS	MY12360820	PARQUE DAS EMAS	09/12/2020 01:22	09/12/2020 09:30	09/12/2020 01:22	09/12/2020 09:30	8,12	9	73,06	CHI
20201245156	APARECIDA DE GOIANIA	200492706	INDEPENDENCIA S1	09/12/2020 01:23	09/12/2020 07:59	09/12/2020 01:23	09/12/2020 07:59	6,58	1	6,58	CHI
20201246198	SILVANIA	SV12340735	VIANOPOLIS	09/12/2020 01:32	09/12/2020 12:43	09/12/2020 01:32	09/12/2020 12:43	11,18	46	514,14	CHI
20201245162	PONTALINA	CQ12028525RE	PONTALINA	09/12/2020 01:35	09/12/2020 08:37	09/12/2020 01:35	09/12/2020 08:37	7,02	34	238,76	CHI
20201245162	MAIRIPOTABA	CQ12028525RE	PONTALINA	09/12/2020 01:35	09/12/2020 08:37	09/12/2020 01:35	09/12/2020 08:37	7,02	51	358,13	CHI
20201245164	GAMELEIRA DE GOIAS	AA12291825	ANAPOLIS UNIVERSITARIO S1	09/12/2020 01:36	09/12/2020 13:01	09/12/2020 01:36	09/12/2020 08:19	6,71	1	6,71	CHI
20201245164	ABADIANIA	AA12291825	ANAPOLIS UNIVERSITARIO S1	09/12/2020 01:36	09/12/2020 13:01	09/12/2020 01:36	09/12/2020 08:19	6,71	6	40,28	CHI
20201245164	ABADIANIA	AA12291825	ANAPOLIS UNIVERSITARIO S1	09/12/2020 01:36	09/12/2020 13:01	09/12/2020 01:36	09/12/2020 13:01	11,41	2	22,82	CHI
20201245164	ABADIANIA	AA12291825	ANAPOLIS UNIVERSITARIO S1	09/12/2020 01:36	09/12/2020 13:01	09/12/2020 12:00	09/12/2020 13:01	1,01	6	6,07	CHI
20201245164	GAMELEIRA DE GOIAS	AA12291825	ANAPOLIS UNIVERSITARIO S1	09/12/2020 01:36	09/12/2020 13:01	09/12/2020 12:00	09/12/2020 13:01	1,01	1	1,01	CHI
20201245171	ITAUCU	IX12000012	INHUMAS S1	09/12/2020 01:46	09/12/2020 05:34	09/12/2020 01:46	09/12/2020 05:34	3,78	233	881,90	CHI
20201247157	FAINA	FC12038664	GOIAS	09/12/2020 01:47	09/12/2020 16:33	09/12/2020 01:47	09/12/2020 16:33	14,75	10	147,53	CHI
20201245175	ITUMBIARA	IT12257023RE	ITUMBIARA NOVA	09/12/2020 01:53	09/12/2020 10:03	09/12/2020 01:53	09/12/2020 10:03	8,16	67	546,53	CHI
20201247550	GOIATUBA	GT12052882	GOIATUBA S1	09/12/2020 01:53	09/12/2020 20:02	09/12/2020 01:53	09/12/2020 20:02	18,14	29	526,13	CHI
20201247447	MORRINHOS	MR12000150	MORRINHOS	09/12/2020 02:02	09/12/2020 11:15	09/12/2020 02:02	09/12/2020 11:15	9,20	28	257,66	CHI
20201245185	MUNDO NOVO DE GOIAS	MH12170094	NOVA CRIXAS	09/12/2020 02:04	09/12/2020 07:01	09/12/2020 02:04	09/12/2020 07:01	4,94	4	19,75	CHI
20201245188	CATALAO	CT12134368	CATALAO S1	09/12/2020 02:07	09/12/2020 17:05	09/12/2020 02:07	09/12/2020 17:05	14,96	14	209,49	CHI
20201245189	MONTES CLAROS DE GOIAS	ME12204905	IPORA	09/12/2020 02:07	09/12/2020 12:54	09/12/2020 02:07	09/12/2020 12:54	10,77	48	517,05	CHI
20201245189	DIORAMA	ME12204905	IPORA	09/12/2020 02:07	09/12/2020 12:54	09/12/2020 02:07	09/12/2020 12:54	10,77	1	10,77	CHI
20201245191	CATALAO	CT12195398RE	CATALAO S1	09/12/2020 02:08	09/12/2020 10:20	09/12/2020 02:08	09/12/2020 10:20	8,19	107	876,27	CHI
20201245997	AMARALINA	MU12390477	MARA ROSA	09/12/2020 02:08	09/12/2020 10:29	09/12/2020 02:08	09/12/2020 10:29	8,35	93	776,55	CHI
20201245193	CRISTALINA	KR21137501	CRISTALINA S2	09/12/2020 02:12	09/12/2020 05:03	09/12/2020 02:12	09/12/2020 05:03	2,84	1	2,84	CHI
20201245195	PIRES DO RIO	PR21407522	PIRES DO RIO S2	09/12/2020 02:16	09/12/2020 12:42	09/12/2020 02:16	09/12/2020 12:42	10,43	1	10,43	CHI
20201245198	SENADOR CANEDO	SW12392762	SENADOR CANEDO	09/12/2020 02:22	09/12/2020 03:15	09/12/2020 02:22	09/12/2020 03:15	0,88	664	584,69	CHI
20201245562	SANTA CRUZ DE GOIAS	BC12110028RE	PIRES DO RIO S2	09/12/2020 02:32	09/12/2020 20:06	09/12/2020 02:32	09/12/2020 10:10	7,63	16	122,16	CHI
20201245562	SANTA CRUZ DE GOIAS	BC12110028RE	PIRES DO RIO S2	09/12/2020 02:32	09/12/2020 20:06	09/12/2020 02:32	09/12/2020 15:11	12,65	2	25,30	CHI
20201245562	SANTA CRUZ DE GOIAS	BC12110028RE	PIRES DO RIO S2	09/12/2020 02:32	09/12/2020 20:06	09/12/2020 02:32	09/12/2020 20:06	17,56	2	35,11	CHI
20201245214	RIO VERDE	RV10402217	CABRIUVA S2	09/12/2020 02:41	09/12/2020 15:50	09/12/2020 02:41	09/12/2020 09:45	7,06	46	324,61	CHI
20201245214	JATAI	RV10402217	CABRIUVA S2	09/12/2020 02:41	09/12/2020 15:50	09/12/2020 02:41	09/12/2020 09:45	7,06	12	84,68	CHI
20201245214	RIO VERDE	RV10402217	CABRIUVA S2	09/12/2020 02:41	09/12/2020 15:50	09/12/2020 02:41	09/12/2020 15:50	13,14	1	13,14	CHI
20201245410	GOIATUBA	GT12296905	GOIATUBA S2	09/12/2020 02:51	09/12/2020 09:26	09/12/2020 02:51	09/12/2020 09:26	6,58	7	46,07	CHI
20201245328	ITUMBIARA	BG12000053	ITUMBIARA VELHA S2	09/12/2020 03:03	09/12/2020 07:59	09/12/2020 03:03	09/12/2020 07:59	4,93	10	49,29	CHI
20201245504	CALDAS NOVAS	CN12222468	SERRA DE CALDAS	09/12/2020 03:04	09/12/2020 09:56	09/12/2020 03:04	09/12/2020 09:56	6,85	160	1096,18	CHI
20201246679	APARECIDA DE GOIANIA	AO12000103RE	GUAPO S2	09/12/2020 03:05	09/12/2020 15:40	09/12/2020 03:05	09/12/2020 14:14	11,15	2	22,30	CHI
20201246679	HIDROLANDIA	AO12000103RE	GUAPO S2	09/12/2020 03:05	09/12/2020 15:40	09/12/2020 03:05	09/12/2020 14:14	11,15	2	22,30	CHI
20201246679	ARAGOIANIA	AO12000103RE	GUAPO S2	09/12/2020 03:05	09/12/2020 15:40	09/12/2020 03:05	09/12/2020 14:14	11,15	461	5140,02	CHI
20201246679	ARAGOIANIA	AO11132422	GUAPO S2	09/12/2020 03:05	09/12/2020 15:40	09/12/2020 15:30	09/12/2020 15:40	0,17	26	4,32	CHI
20201246218	SANTA BARBARA DE GOIAS	TR12062862	TRINDADE	09/12/2020 03:09	09/12/2020 11:49	09/12/2020 03:09	09/12/2020 11:49	8,67	11	95,41	CHI
20201246218	TRINDADE	TR12062862	TRINDADE	09/12/2020 03:09	09/12/2020 11:49	09/12/2020 03:09	09/12/2020 11:49	8,67	20	173,47	CHI
20201245230	TRINDADE	GR31034890	TRINDADE	09/12/2020 03:11	09/12/2020 05:34	09/12/2020 03:11	09/12/2020 05:34	2,38	1	2,38	CHI

20201245232	SILVANIA	VN12400021	VIANOPOLIS	09/12/2020 03:11	09/12/2020 13:06	09/12/2020 03:11	09/12/2020 13:06	9,91	6	59,48	CHI
20201245232	VIANOPOLIS	VN12400021	VIANOPOLIS	09/12/2020 03:11	09/12/2020 13:06	09/12/2020 03:11	09/12/2020 13:06	9,91	9	89,23	CHI
20201245232	SILVANIA	VN12400021	VIANOPOLIS	09/12/2020 03:11	09/12/2020 13:06	09/12/2020 03:11	09/12/2020 13:06	9,91	82	812,94	CHI
20201245232	LUZIANIA	VN12400021	VIANOPOLIS	09/12/2020 03:11	09/12/2020 13:06	09/12/2020 03:11	09/12/2020 13:06	9,91	103	1021,13	CHI
20201245232	ORIZONA	VN12400021	VIANOPOLIS	09/12/2020 03:11	09/12/2020 13:06	09/12/2020 03:11	09/12/2020 13:06	9,91	87	862,51	CHI
20201245235	CAMPO LIMPO	CV21382477	NEROPOLIS S1	09/12/2020 03:17	09/12/2020 08:03	09/12/2020 03:17	09/12/2020 08:03	4,76	1	4,76	CHI
20201245510	ITAGUARU	IC12219937	ITABERAI S1	09/12/2020 03:20	09/12/2020 10:05	09/12/2020 03:20	09/12/2020 10:05	6,75	2	13,50	CHI
20201245510	ITAGUARI	IC12219937	ITABERAI S1	09/12/2020 03:20	09/12/2020 10:05	09/12/2020 03:20	09/12/2020 10:05	6,75	25	168,74	CHI
20201247268	ARENOPOLIS	AY12000044	ARENOPOLIS	09/12/2020 03:32	09/12/2020 15:07	09/12/2020 03:32	09/12/2020 15:07	11,58	8	92,61	CHI
20201245242	SILVANIA	SV12241078	VIANOPOLIS	09/12/2020 03:34	10/12/2020 11:22	09/12/2020 03:34	09/12/2020 10:40	7,09	29	205,74	CHI
20201245242	SILVANIA	SV12241078	VIANOPOLIS	09/12/2020 03:34	10/12/2020 11:22	09/12/2020 03:34	10/12/2020 10:50	31,27	17	531,54	CHI
20201245242	SILVANIA	SV12241078	VIANOPOLIS	09/12/2020 03:34	10/12/2020 11:22	09/12/2020 03:34	10/12/2020 11:22	31,79	5	158,97	CHI
20201245245	NOVA IGUACU DE GOIAS	UR10408084	URUACU	09/12/2020 03:34	09/12/2020 06:10	09/12/2020 03:40	09/12/2020 06:10	2,50	20	50,03	CHI
20201245245	URUACU	UR10408084	URUACU	09/12/2020 03:34	09/12/2020 06:10	09/12/2020 03:40	09/12/2020 06:10	2,50	165	412,77	CHI
20201245245	PILAR DE GOIAS	UR10408084	URUACU	09/12/2020 03:34	09/12/2020 06:10	09/12/2020 03:40	09/12/2020 06:10	2,50	1	2,50	CHI
20201249209	JATAI	JT12062164	JATAI S1	09/12/2020 03:37	10/12/2020 02:47	09/12/2020 03:37	10/12/2020 02:47	23,17	3	69,50	CHI
20201245979	URUACU	UR11135596	URUACU	09/12/2020 03:50	09/12/2020 12:00	09/12/2020 03:50	09/12/2020 12:00	8,16	187	1526,70	CHI
20201248549	ITAUCU	IX11141972	INHUMAS S1	09/12/2020 03:55	09/12/2020 14:46	09/12/2020 03:55	09/12/2020 14:46	10,84	203	2199,90	CHI
20201245487	GOIANIA	GN11167775	FERROVIARIO S1	09/12/2020 03:57	09/12/2020 07:25	09/12/2020 03:57	09/12/2020 07:25	3,46	160	554,27	CHI
20201243214	RIO VERDE	RV18214126TS	RIO VERDE S1	09/12/2020 04:06	09/12/2020 14:52	09/12/2020 04:06	09/12/2020 12:20	8,22	42	345,20	CHI
20201243214	SANTA HELENA DE GOIAS	RV18214126TS	RIO VERDE S1	09/12/2020 04:06	09/12/2020 14:52	09/12/2020 04:06	09/12/2020 12:20	8,22	25	205,48	CHI
20201243214	RIO VERDE	SH32159320LD	RIO VERDE S1	09/12/2020 04:06	09/12/2020 14:52	09/12/2020 04:06	09/12/2020 14:24	10,30	21	216,26	CHI
20201243214	SANTA HELENA DE GOIAS	SH32159320LD	RIO VERDE S1	09/12/2020 04:06	09/12/2020 14:52	09/12/2020 04:06	09/12/2020 14:24	10,30	21	216,26	CHI
20201243214	RIO VERDE	RV12296077LD	RIO VERDE S1	09/12/2020 04:06	09/12/2020 14:52	09/12/2020 04:06	09/12/2020 14:52	10,76	10	107,56	CHI
20201245557	ITUMBIARA	ID12359397LD	QUIRINOPOLIS	09/12/2020 04:06	09/12/2020 14:55	09/12/2020 04:06	09/12/2020 14:55	10,82	3	32,47	CHI
20201245557	INACIOLANDIA	ID12359397LD	QUIRINOPOLIS	09/12/2020 04:06	09/12/2020 14:55	09/12/2020 04:06	09/12/2020 14:55	10,82	57	616,98	CHI
20201246228	LUZIANIA	LZ12085964	PACAEMBU S2	09/12/2020 04:09	09/12/2020 08:40	09/12/2020 04:09	09/12/2020 08:40	4,50	31	139,55	CHI
20201246228	NOVO GAMA	LZ12085964	PACAEMBU S2	09/12/2020 04:09	09/12/2020 08:40	09/12/2020 04:09	09/12/2020 08:40	4,50	19	85,53	CHI
20201239839	FIRMINOPOLIS	FR12028946	FIRMINOPOLIS S1	09/12/2020 04:10	09/12/2020 09:37	09/12/2020 04:10	09/12/2020 09:37	5,43	21	114,12	CHI
20201245274	OURO VERDE DE GOIAS	OV12014230	INHUMAS S1	09/12/2020 04:10	09/12/2020 09:34	09/12/2020 04:10	09/12/2020 09:34	5,40	50	269,94	CHI
20201246174	PIRENOPOLIS	PV12381260	CORUMBA	09/12/2020 04:14	09/12/2020 10:33	09/12/2020 04:14	09/12/2020 10:33	6,31	76	479,26	CHI
20201245745	SAO MIGUEL DO ARAGUAIA	SM12096096	SAO MIGUEL DO ARAGUAIA	09/12/2020 04:15	09/12/2020 08:30	09/12/2020 04:15	09/12/2020 08:30	4,23	13	55,04	CHI
20201245284	CALDAS NOVAS	10031132454	SERRA DE CALDAS	09/12/2020 04:23	09/12/2020 15:00	09/12/2020 04:23	09/12/2020 15:00	10,61	1	10,61	CHI
20201245290	PIRACANJUBA	60039498	PIRACANJUBA	09/12/2020 04:33	09/12/2020 21:41	09/12/2020 04:33	09/12/2020 21:41	17,13	1	17,13	CHI
20201245292	CRISTALINA	KR12097123	CRISTALINA S2	09/12/2020 04:35	09/12/2020 11:42	09/12/2020 04:35	09/12/2020 11:42	7,11	3	21,34	CHI
20201245295	CAMPOS VERDES	VD12201660RE	SANTA TEREZINHA	09/12/2020 04:36	09/12/2020 16:14	09/12/2020 04:36	09/12/2020 16:14	11,62	21	244,08	CHI
20201245295	SANTA TEREZINHA DE GOIAS	VD12201660RE	SANTA TEREZINHA	09/12/2020 04:36	09/12/2020 16:14	09/12/2020 04:36	09/12/2020 16:14	11,62	47	546,28	CHI
20201246237	FAINA	FC12274421	GOIAS	09/12/2020 04:37	09/12/2020 09:04	09/12/2020 04:37	09/12/2020 09:04	4,44	18	79,95	CHI
20201245299	CATALAO	OU12250323LD	CATALAO S1	09/12/2020 04:38	09/12/2020 09:21	09/12/2020 04:38	09/12/2020 09:21	4,71	5	23,54	CHI
20201245299	OUVIDOR	OU12250323LD	CATALAO S1	09/12/2020 04:38	09/12/2020 09:21	09/12/2020 04:38	09/12/2020 09:21	4,71	2	9,42	CHI
20201245304	NOVA CRIXAS	MZ10404285	MOZARLANDIA	09/12/2020 04:41	09/12/2020 20:21	09/12/2020 04:44	09/12/2020 06:00	1,27	28	35,47	CHI
20201245304	MOZARLANDIA	MZ10404285	MOZARLANDIA	09/12/2020 04:41	09/12/2020 20:21	09/12/2020 04:44	09/12/2020 06:00	1,27	81	102,62	CHI
20201245304	CRIXAS	MZ10404285	MOZARLANDIA	09/12/2020 04:41	09/12/2020 20:21	09/12/2020 04:44	09/12/2020 06:00	1,27	100	126,69	CHI
20201245304	MOZARLANDIA	MZ10404285	MOZARLANDIA	09/12/2020 04:41	09/12/2020 20:21	09/12/2020 06:49	09/12/2020 08:04	1,26	76	95,49	CHI
20201245304	CRIXAS	MZ10404285	MOZARLANDIA	09/12/2020 04:41	09/12/2020 20:21	09/12/2020 06:49	09/12/2020 08:04	1,26	26	32,67	CHI
20201245304	MOZARLANDIA	NA13307451	MOZARLANDIA	09/12/2020 04:41	09/12/2020 20:21	09/12/2020 06:49	09/12/2020 10:18	3,49	2	6,98	CHI
20201245304	NOVA CRIXAS	NA13307451	MOZARLANDIA	09/12/2020 04:41	09/12/2020 20:21	09/12/2020 06:49	09/12/2020 10:18	3,49	24	83,72	CHI
20201245304	MOZARLANDIA	MZ12150974LD	MOZARLANDIA	09/12/2020 04:41	09/12/2020 20:21	09/12/2020 06:49	09/12/2020 13:31	6,71	2	13,43	CHI
20201245304	NOVA CRIXAS	MZ12150974LD	MOZARLANDIA	09/12/2020 04:41	09/12/2020 20:21	09/12/2020 06:49	09/12/2020 13:31	6,71	4	26,86	CHI
20201245304	CRIXAS	MZ12150974LD	MOZARLANDIA	09/12/2020 04:41	09/12/2020 20:21	09/12/2020 06:49	09/12/2020 13:31	6,71	6	40,28	CHI
20201245304	CRIXAS	CX12250761LD	MOZARLANDIA	09/12/2020 04:41	09/12/2020 20:21	09/12/2020 06:49	09/12/2020 17:48	10,99	49	538,46	CHI

20201245304	MOZARLANDIA	CX13220518	MOZARLANDIA	09/12/2020 04:41	09/12/2020 20:21	09/12/2020 06:49	09/12/2020 19:34	12,77	1	12,77	CHI
20201245304	CRIXAS	CX13220518	MOZARLANDIA	09/12/2020 04:41	09/12/2020 20:21	09/12/2020 06:49	09/12/2020 19:34	12,77	5	63,83	CHI
20201245304	CRIXAS	CX12230555	MOZARLANDIA	09/12/2020 04:41	09/12/2020 20:21	09/12/2020 06:49	09/12/2020 20:21	13,54	14	189,56	CHI
20201245832	MONTES CLAROS DE GOIAS	ME12088949	IPORA	09/12/2020 04:46	09/12/2020 09:11	09/12/2020 04:46	09/12/2020 09:11	4,41	50	220,46	CHI
20201245527	GOIANIA	GN11220956	GOYA S2	09/12/2020 04:50	09/12/2020 11:44	09/12/2020 04:50	09/12/2020 11:44	6,90	202	1392,85	CHI
20201243024	FORMOSA	FB12106993	FLORES DE GOIAS	09/12/2020 04:53	09/12/2020 12:55	09/12/2020 04:53	09/12/2020 12:55	8,03	138	1107,83	CHI
20201243024	SAO JOAO D ALIANCA	FB12106993	FLORES DE GOIAS	09/12/2020 04:53	09/12/2020 12:55	09/12/2020 04:53	09/12/2020 12:55	8,03	5	40,14	CHI
20201243024	FLORES DE GOIAS	FB12106993	FLORES DE GOIAS	09/12/2020 04:53	09/12/2020 12:55	09/12/2020 04:53	09/12/2020 12:55	8,03	14	112,39	CHI
20201243024	FORMOSO	FB12106993	FLORES DE GOIAS	09/12/2020 04:53	09/12/2020 12:55	09/12/2020 04:53	09/12/2020 12:55	8,03	1	8,03	CHI
20201245117	ITAPIRAPUA	IU12020177	JUSSARA	09/12/2020 04:54	09/12/2020 08:23	09/12/2020 04:54	09/12/2020 08:23	3,48	93	323,23	CHI
20201245311	PORTEIROAO	O2650416	RIO DOS BOIS	09/12/2020 04:56	09/12/2020 09:21	09/12/2020 04:56	09/12/2020 09:20	4,40	1609	7077,37	CHI
20201245311	VICENTINOPOLIS	O2650416	RIO DOS BOIS	09/12/2020 04:56	09/12/2020 09:21	09/12/2020 04:56	09/12/2020 09:21	4,40	4	17,61	CHI
20201245311	TURVELANDIA	O2650416	RIO DOS BOIS	09/12/2020 04:56	09/12/2020 09:21	09/12/2020 04:56	09/12/2020 09:21	4,40	10	44,03	CHI
20201245311	ACREUNA	O2650416	RIO DOS BOIS	09/12/2020 04:56	09/12/2020 09:21	09/12/2020 04:56	09/12/2020 09:21	4,40	1	4,40	CHI
20201245311	PORTEIROAO	O2650416	RIO DOS BOIS	09/12/2020 04:56	09/12/2020 09:21	09/12/2020 04:56	09/12/2020 09:21	4,40	35	154,10	CHI
20201245311	GOIATUBA	O2650416	RIO DOS BOIS	09/12/2020 04:56	09/12/2020 09:21	09/12/2020 04:56	09/12/2020 09:21	4,40	10	44,03	CHI
20201245311	EDEIA	O2650416	RIO DOS BOIS	09/12/2020 04:56	09/12/2020 09:21	09/12/2020 04:56	09/12/2020 09:21	4,40	41	180,51	CHI
20201246835	PADRE BERNARDO	PB12382939	PADRE BERNARDO	09/12/2020 04:57	09/12/2020 10:51	09/12/2020 04:57	09/12/2020 10:51	5,89	7	41,21	CHI
20201245316	IPAMERI	GD12075517LD	IPAMERI	09/12/2020 04:59	09/12/2020 20:58	09/12/2020 04:59	09/12/2020 20:58	15,97	14	223,63	CHI
20201245318	SENADOR CANEDO	SW12391634	SENADOR CANEDO	09/12/2020 05:01	10/12/2020 19:50	09/12/2020 05:01	09/12/2020 18:21	13,34	6	80,02	CHI
20201245318	SENADOR CANEDO	SW12391634	SENADOR CANEDO	09/12/2020 05:01	10/12/2020 19:50	09/12/2020 10:56	09/12/2020 18:21	7,42	2	14,84	CHI
20201245318	SENADOR CANEDO	SW12391634	SENADOR CANEDO	09/12/2020 05:01	10/12/2020 19:50	09/12/2020 05:01	10/12/2020 11:58	30,95	3	92,86	CHI
20201245318	SENADOR CANEDO	SW32080130	SENADOR CANEDO	09/12/2020 05:01	10/12/2020 19:50	09/12/2020 10:56	10/12/2020 17:00	30,07	1	30,07	CHI
20201245318	SENADOR CANEDO	SW32080130	SENADOR CANEDO	09/12/2020 05:01	10/12/2020 19:50	10/12/2020 10:40	10/12/2020 17:00	6,32	3	18,96	CHI
20201245318	SENADOR CANEDO	SW12391634	SENADOR CANEDO	09/12/2020 05:01	10/12/2020 19:50	09/12/2020 05:01	10/12/2020 19:50	38,82	3	116,45	CHI
20201245521	SAO JOAO DA PARAUNA	RP12024465	FIRMINOPOLIS S2	09/12/2020 05:02	09/12/2020 08:48	09/12/2020 05:02	09/12/2020 08:48	3,76	5	18,78	CHI
20201245323	GOIANIRA	GR11366120	GOIANIRA	09/12/2020 05:03	09/12/2020 08:57	09/12/2020 05:03	09/12/2020 08:57	3,90	40	155,89	CHI
20201247187	CAIAPONIA	DV12332038	CAIAPONIA	09/12/2020 05:04	09/12/2020 13:19	09/12/2020 05:04	09/12/2020 13:19	8,24	23	189,60	CHI
20201247187	DOVERLANDIA	DV12332038	CAIAPONIA	09/12/2020 05:04	09/12/2020 13:19	09/12/2020 05:04	09/12/2020 13:19	8,24	29	239,06	CHI
20201245326	CAIAPONIA	CP12200873	PALESTINA	09/12/2020 05:05	09/12/2020 11:36	09/12/2020 05:05	09/12/2020 11:36	6,51	98	637,63	CHI
20201245669	ITAPURANGA	IK12250613	ITAPURANGA	09/12/2020 05:10	09/12/2020 11:12	09/12/2020 05:10	09/12/2020 11:12	6,03	30	181,00	CHI
20201247136	SANTA ROSA DE GOIAS	IN12028765	INHUMAS S2	09/12/2020 05:12	09/12/2020 19:50	09/12/2020 05:12	09/12/2020 19:50	14,62	11	160,81	CHI
20201247136	ITAUCU	IN12028765	INHUMAS S2	09/12/2020 05:12	09/12/2020 19:50	09/12/2020 05:12	09/12/2020 19:50	14,62	33	482,43	CHI
20201247136	INHUMAS	IN12028765	INHUMAS S2	09/12/2020 05:12	09/12/2020 19:50	09/12/2020 05:12	09/12/2020 19:50	14,62	2	29,24	CHI
20201245333	FAINA	FC12124752	GOIAS	09/12/2020 05:13	09/12/2020 07:01	09/12/2020 05:13	09/12/2020 07:01	1,79	27	48,33	CHI
20201245898	QUIRINOPOLIS	DM12153969	RIO DOS BOIS	09/12/2020 05:14	09/12/2020 13:54	09/12/2020 05:14	09/12/2020 13:54	8,67	9	77,99	CHI
20201245898	BOM JESUS DE GOIAS	DM12153969	RIO DOS BOIS	09/12/2020 05:14	09/12/2020 13:54	09/12/2020 05:14	09/12/2020 13:54	8,67	1	8,67	CHI
20201245898	CASTELANDIA	DM12153969	RIO DOS BOIS	09/12/2020 05:14	09/12/2020 13:54	09/12/2020 05:14	09/12/2020 13:54	8,67	6	51,99	CHI
20201248900	MORRO AGUDO DE GOIAS	MS12376415	ITAPURANGA	09/12/2020 05:15	09/12/2020 14:41	09/12/2020 05:15	09/12/2020 14:41	9,42	9	84,82	CHI
20201245139	MUNDO NOVO DE GOIAS	MH12362454	NOVA CRIXAS	09/12/2020 05:16	09/12/2020 08:25	09/12/2020 05:16	09/12/2020 08:25	3,14	237	743,52	CHI
20201245139	AMARALINA	MH12362454	NOVA CRIXAS	09/12/2020 05:16	09/12/2020 08:25	09/12/2020 05:16	09/12/2020 08:25	3,14	1	3,14	CHI
20201246224	EDEALINA	EA12105005	VICENTINOPOLIS	09/12/2020 05:16	11/12/2020 19:44	09/12/2020 05:16	11/12/2020 19:44	62,46	3	187,39	CHI
20201246224	EDEIA	EA12105005	VICENTINOPOLIS	09/12/2020 05:16	11/12/2020 19:44	09/12/2020 05:16	11/12/2020 19:44	62,46	4	249,85	CHI
20201245374	MUNDO NOVO DE GOIAS	MH11275562	NOVA CRIXAS	09/12/2020 05:16	10/12/2020 00:15	09/12/2020 05:16	10/12/2020 00:15	18,97	1	18,97	CHI
20201245407	RIO VERDE	RV12303286	CABRIUVA S2	09/12/2020 05:18	09/12/2020 07:33	09/12/2020 05:18	09/12/2020 07:33	2,25	9	20,25	CHI
20201245372	ANAPOLIS	AN11319807	JUNDIAI S2	09/12/2020 05:21	09/12/2020 13:20	09/12/2020 05:21	09/12/2020 13:20	7,98	31	247,35	CHI
20201245351	FORMOSA	FA21017449	ITUIQUIRA	09/12/2020 05:24	09/12/2020 13:08	09/12/2020 05:24	09/12/2020 13:08	7,73	1	7,73	CHI
20201245352	SAO MIGUEL DO ARAGUAIA	SM11393945	SAO MIGUEL DO ARAGUAIA	09/12/2020 05:24	09/12/2020 11:43	09/12/2020 05:24	09/12/2020 11:43	6,30	1	6,30	CHI
20201245353	NIQUELANDIA	NQ12207364	BARRO ALTO	09/12/2020 05:24	09/12/2020 11:39	09/12/2020 05:24	09/12/2020 11:39	6,23	27	168,31	CHI
20201245353	MIMOSO DE GOIAS	NQ12207364	BARRO ALTO	09/12/2020 05:24	09/12/2020 11:39	09/12/2020 05:24	09/12/2020 11:39	6,23	4	24,93	CHI
20201246152	FAINA	FC12147792LD	GOIAS	09/12/2020 05:25	09/12/2020 16:21	09/12/2020 14:00	09/12/2020 16:05	2,09	5	10,44	CHI

20201246152	FAINA	FC12147817LD	GOIAS	09/12/2020 05:25	09/12/2020 16:21	09/12/2020 05:25	09/12/2020 16:21	10,94	38	415,62	CHI
20201245356	FORMOSA	FA21120055	ITUIQUIRA	09/12/2020 05:26	09/12/2020 12:53	09/12/2020 05:26	09/12/2020 12:53	7,45	1	7,45	CHI
20201245417	MUTUNOPOLIS	MU12291187	MARA ROSA	09/12/2020 05:28	09/12/2020 15:26	09/12/2020 05:28	09/12/2020 15:26	9,95	2	19,90	CHI
20201245703	PALMEIRAS DE GOIAS	PL12308411	PALMEIRAS	09/12/2020 05:29	09/12/2020 09:35	09/12/2020 05:29	09/12/2020 09:35	4,10	173	709,44	CHI
20201245364	FLORES DE GOIAS	FB12320627	FLORES DE GOIAS	09/12/2020 05:30	09/12/2020 13:09	09/12/2020 05:30	09/12/2020 13:09	7,65	17	130,02	CHI
20201246485	GUAPO	AO12095512	GUAPO S2	09/12/2020 05:30	09/12/2020 15:40	09/12/2020 05:30	09/12/2020 15:40	10,16	10	101,61	CHI
20201246485	ARAGOIANIA	AO12095512	GUAPO S2	09/12/2020 05:30	09/12/2020 15:40	09/12/2020 05:30	09/12/2020 15:40	10,16	19	193,05	CHI
20201245367	GOIANIA	10002094442	XAVANTES	09/12/2020 05:31	09/12/2020 07:45	09/12/2020 05:31	09/12/2020 07:45	2,23	1	2,23	CHI
20201245478	VIANOPOLIS	VN12114852	VIANOPOLIS	09/12/2020 05:31	09/12/2020 23:54	09/12/2020 05:31	09/12/2020 23:54	18,37	53	973,68	CHI
20201246213	GOIANIA	GN11001267	CARAJAS S2	09/12/2020 05:31	09/12/2020 10:29	09/12/2020 05:31	09/12/2020 10:29	4,96	169	838,85	CHI
20201247269	SANCLERLANDIA	MD12057741	FIRMINOPOLIS S2	09/12/2020 05:32	09/12/2020 12:35	09/12/2020 05:32	09/12/2020 12:35	7,05	1	7,05	CHI
20201247269	MOSSAMEDES	MD12057741	FIRMINOPOLIS S2	09/12/2020 05:32	09/12/2020 12:35	09/12/2020 05:32	09/12/2020 12:35	7,05	18	126,87	CHI
20201245378	LUZIANIA	LZ21059751	PAMPLONA	09/12/2020 05:35	10/12/2020 00:58	09/12/2020 05:35	10/12/2020 00:58	19,38	1	19,38	CHI
20201245379	NEROPOLIS	NR12000048	NEROPOLIS S2	09/12/2020 05:35	09/12/2020 07:32	09/12/2020 05:35	09/12/2020 07:32	1,94	16	31,12	CHI
20201245380	BALIZA	BH21238895	BOM JARDIM	09/12/2020 05:35	09/12/2020 11:04	09/12/2020 05:35	09/12/2020 11:04	5,47	1	5,47	CHI
20201245383	PARAUNA	PU12388915	PARAUNA	09/12/2020 05:36	09/12/2020 11:58	09/12/2020 05:36	09/12/2020 11:58	6,36	3	19,09	CHI
20201245384	APARECIDA DE GOIANIA	200508568	INDEPENDENCIA S2	09/12/2020 05:36	09/12/2020 09:15	09/12/2020 05:36	09/12/2020 09:15	3,64	1	3,64	CHI
20201245805	MARA ROSA	MQ12028228	MARA ROSA	09/12/2020 05:36	09/12/2020 18:04	09/12/2020 05:36	09/12/2020 18:04	12,46	16	199,42	CHI
20201245461	ITABERAI	IK12250721	GOIAS	09/12/2020 05:39	09/12/2020 09:58	09/12/2020 05:39	09/12/2020 09:58	4,30	3	12,91	CHI
20201245461	GOIAS	IK12250721	GOIAS	09/12/2020 05:39	09/12/2020 09:58	09/12/2020 05:39	09/12/2020 09:58	4,30	14	60,25	CHI
20201245461	ITAPURANGA	IK12250721	GOIAS	09/12/2020 05:39	09/12/2020 09:58	09/12/2020 05:39	09/12/2020 09:58	4,30	3	12,91	CHI
20201245813	PADRE BERNARDO	PB12261686	PADRE BERNARDO	09/12/2020 05:39	09/12/2020 11:40	09/12/2020 05:39	09/12/2020 11:40	6,01	8	48,11	CHI
20201245392	VICENTINOPOLIS	VI12166490	VICENTINOPOLIS	09/12/2020 05:40	09/12/2020 14:05	09/12/2020 05:40	09/12/2020 14:05	8,40	2	16,81	CHI
20201249560	PETROLINA DE GOIAS	PG12297874	PETROLINA	09/12/2020 05:42	10/12/2020 02:29	09/12/2020 05:42	10/12/2020 02:29	20,78	13	270,13	CHI
20201245397	ITUMBIARA	BG12363928	ITUMBIARA VELHA S2	09/12/2020 05:43	09/12/2020 11:38	09/12/2020 05:43	09/12/2020 11:38	5,91	5	29,53	CHI
20201246192	NOVA CRIXAS	NA12158761	NOVA CRIXAS	09/12/2020 05:43	09/12/2020 08:47	09/12/2020 05:43	09/12/2020 08:47	3,06	6	18,34	CHI
20201245403	PIRENOPOLIS	PV12316020	CORUMBA	09/12/2020 05:44	10/12/2020 14:10	09/12/2020 05:44	10/12/2020 14:10	32,42	14	453,85	CHI
20201247485	ITAGUARI	IC18219941TS	ITABERAI S1	09/12/2020 05:44	09/12/2020 11:13	09/12/2020 05:44	09/12/2020 11:13	5,47	29	158,66	CHI
20201247485	ITAGUARU	IC18219941TS	ITABERAI S1	09/12/2020 05:44	09/12/2020 11:13	09/12/2020 05:44	09/12/2020 11:13	5,47	20	109,42	CHI
20201245404	MOIPIORA	MO12031774	IPORA	09/12/2020 05:45	09/12/2020 13:34	09/12/2020 05:45	09/12/2020 13:34	7,81	3	23,43	CHI
20201245821	JARAGUA	JA12374473	JARAGUA	09/12/2020 05:47	09/12/2020 16:36	09/12/2020 05:47	09/12/2020 16:36	4,02	79	317,56	CHI
20201245821	JARAGUA	JA12374473	JARAGUA	09/12/2020 05:47	09/12/2020 16:36	09/12/2020 05:47	09/12/2020 16:36	10,80	226	2441,49	CHI
20201245413	BRITANIA	BT12257311	BRITANIA	09/12/2020 05:49	09/12/2020 17:15	09/12/2020 05:49	09/12/2020 17:15	11,42	3	34,27	CHI
20201245413	JUSSARA	BT12257311	BRITANIA	09/12/2020 05:49	09/12/2020 17:15	09/12/2020 05:49	09/12/2020 17:15	11,42	2	22,85	CHI
20201245586	FAINA	GS12086336	GOIAS	09/12/2020 05:50	09/12/2020 08:35	09/12/2020 05:50	09/12/2020 08:35	2,75	22	60,43	CHI
20201248926	GOIAS	GS12188036	GOIAS	09/12/2020 05:50	09/12/2020 16:48	09/12/2020 05:50	09/12/2020 16:48	10,96	36	394,68	CHI
20201245739	CATALAO	CT12250355	CATALAO S1	09/12/2020 05:51	09/12/2020 09:21	09/12/2020 05:51	09/12/2020 09:21	3,49	8	27,92	CHI
20201249126	MOSSAMEDES	MD12005317	FIRMINOPOLIS S2	09/12/2020 05:51	09/12/2020 14:17	09/12/2020 05:51	09/12/2020 14:17	8,43	11	92,71	CHI
20201245426	SENADOR CANEDO	SW12240932	CEPAIGO S1	09/12/2020 05:52	09/12/2020 11:07	09/12/2020 05:52	09/12/2020 11:07	5,25	10	52,47	CHI
20201245429	BELA VISTA DE GOIAS	BV32249964	BELA VISTA S1	09/12/2020 05:52	09/12/2020 09:16	09/12/2020 05:52	09/12/2020 09:16	3,39	72	243,92	CHI
20201245435	POSSE	SA12320454	IACIARA S2	09/12/2020 05:54	09/12/2020 08:52	09/12/2020 05:54	09/12/2020 08:52	2,96	28	82,83	CHI
20201245437	IACIARA	GY12257673	IACIARA S1	09/12/2020 05:55	09/12/2020 07:31	09/12/2020 05:55	09/12/2020 07:31	1,60	6	9,60	CHI
20201245437	GUARANI DE GOIAS	GY12257673	IACIARA S1	09/12/2020 05:55	09/12/2020 07:31	09/12/2020 05:55	09/12/2020 07:31	1,60	76	121,56	CHI
20201245479	SAO MIGUEL DO PASSA QUATRO	BV32058332	BELA VISTA S2	09/12/2020 05:56	10/12/2020 04:08	09/12/2020 05:56	09/12/2020 16:22	10,44	22	229,70	CHI
20201245479	SAO MIGUEL DO PASSA QUATRO	BV32058332	BELA VISTA S2	09/12/2020 05:56	10/12/2020 04:08	09/12/2020 18:09	09/12/2020 19:37	1,46	22	32,19	CHI
20201245479	SAO MIGUEL DO PASSA QUATRO	BV32058332	BELA VISTA S2	09/12/2020 05:56	10/12/2020 04:08	09/12/2020 05:56	10/12/2020 02:12	20,28	2	40,55	CHI
20201245479	SAO MIGUEL DO PASSA QUATRO	BV32058332	BELA VISTA S2	09/12/2020 05:56	10/12/2020 04:08	09/12/2020 05:56	10/12/2020 02:33	20,62	2	41,24	CHI
20201245479	SAO MIGUEL DO PASSA QUATRO	BV32058332	BELA VISTA S2	09/12/2020 05:56	10/12/2020 04:08	09/12/2020 05:56	10/12/2020 04:08	22,21	11	244,27	CHI
20201245611	MARA ROSA	MQ12208423	MARA ROSA	09/12/2020 05:56	09/12/2020 09:11	09/12/2020 05:56	09/12/2020 09:11	3,24	11	35,63	CHI
20201245886	GOIANDIRA	CT12215606RE	CATALAO S1	09/12/2020 05:56	10/12/2020 16:26	09/12/2020 05:56	10/12/2020 14:06	32,17	12	385,99	CHI
20201245886	CATALAO	CT12215606RE	CATALAO S1	09/12/2020 05:56	10/12/2020 16:26	09/12/2020 05:56	10/12/2020 14:06	32,17	18	578,99	CHI

20201245886	GOIANDIRA	CT12215606RE	CATALAO S1	09/12/2020 05:56	10/12/2020 16:26	09/12/2020 05:56	10/12/2020 14:38	32,69	3	98,07	CHI
20201245886	CATALAO	CT12215606RE	CATALAO S1	09/12/2020 05:56	10/12/2020 16:26	09/12/2020 05:56	10/12/2020 14:38	32,69	1	32,69	CHI
20201245886	GOIANDIRA	CT12215606RE	CATALAO S1	09/12/2020 05:56	10/12/2020 16:26	09/12/2020 05:56	10/12/2020 16:26	34,49	2	68,98	CHI
20201238701	SAO LUIZ DO NORTE	BA12211707	BARRO ALTO	09/12/2020 05:58	09/12/2020 10:33	09/12/2020 05:58	09/12/2020 10:33	4,58	25	114,50	CHI
20201238701	SANTA RITA DO NOVO DESTINO	BA12211707	BARRO ALTO	09/12/2020 05:58	09/12/2020 10:33	09/12/2020 05:58	09/12/2020 10:33	4,58	1	4,58	CHI
20201245655	INHUMAS	IN32066288	INHUMAS S2	09/12/2020 05:58	09/12/2020 21:40	09/12/2020 05:58	09/12/2020 21:40	15,70	8	125,60	CHI
20201245629	SAO MIGUEL DO ARAGUAIA	SM12192361	SAO MIGUEL DO ARAGUAIA	09/12/2020 06:00	09/12/2020 08:28	09/12/2020 06:00	09/12/2020 08:28	2,46	167	410,54	CHI
20201245458	ITABERAI	IB21169223	ITABERAI S1	09/12/2020 06:01	09/12/2020 14:52	09/12/2020 06:01	09/12/2020 14:52	8,85	2	17,69	CHI
20201248740	SANTO ANTONIO DE GOIAS	GR12056290	NEROPOLIS S1	09/12/2020 06:01	09/12/2020 21:40	09/12/2020 06:01	09/12/2020 21:40	15,64	3	46,93	CHI
20201248740	GOIANIRA	GR12056290	NEROPOLIS S1	09/12/2020 06:01	09/12/2020 21:40	09/12/2020 06:01	09/12/2020 21:40	15,64	2	31,29	CHI
20201245462	MINEIROS	MY12303343RE	PARQUE DAS EMAS	09/12/2020 06:02	09/12/2020 15:20	09/12/2020 06:02	09/12/2020 15:20	9,30	4	37,19	CHI
20201245463	UIRAPURU	UP12294696	NOVA CRIXAS	09/12/2020 06:02	09/12/2020 19:44	09/12/2020 06:02	09/12/2020 19:44	13,70	4	54,79	CHI
20201245463	MARA ROSA	UP12294696	NOVA CRIXAS	09/12/2020 06:02	09/12/2020 19:44	09/12/2020 06:02	09/12/2020 19:44	13,70	47	643,82	CHI
20201245463	AMARALINA	UP12294696	NOVA CRIXAS	09/12/2020 06:02	09/12/2020 19:44	09/12/2020 06:02	09/12/2020 19:44	13,70	51	698,61	CHI
20201245463	SANTA TEREZINHA DE GOIAS	UP12294696	NOVA CRIXAS	09/12/2020 06:02	09/12/2020 19:44	09/12/2020 06:02	09/12/2020 19:44	13,70	1	13,70	CHI
20201245464	CAMPO ALEGRE DE GOIAS	CM21042352	CAMPO ALEGRE DE GOIAS	09/12/2020 06:02	09/12/2020 13:55	09/12/2020 06:02	09/12/2020 13:55	7,88	1	7,88	CHI
20201245465	ALTO PARAISO DE GOIAS	NQ12234731	NIQUELANDIA SUBTRANSMISSAO	09/12/2020 06:02	09/12/2020 10:02	09/12/2020 06:02	09/12/2020 10:02	4,00	12	47,97	CHI
20201245465	SAO JOAO D ALIANCA	NQ12234731	NIQUELANDIA SUBTRANSMISSAO	09/12/2020 06:02	09/12/2020 10:02	09/12/2020 06:02	09/12/2020 10:02	4,00	1	4,00	CHI
20201245465	NIQUELANDIA	NQ12234731	NIQUELANDIA SUBTRANSMISSAO	09/12/2020 06:02	09/12/2020 10:02	09/12/2020 06:02	09/12/2020 10:02	4,00	11	43,98	CHI
20201245469	IVOLANDIA	IV21325767	MONTIVIDIU T	09/12/2020 06:02	10/12/2020 01:13	09/12/2020 06:02	10/12/2020 01:13	19,17	1	19,17	CHI
20201249381	GOIANDIRA	GD12078359	CATALAO S1	09/12/2020 06:02	09/12/2020 17:11	09/12/2020 06:02	09/12/2020 17:11	11,15	17	189,53	CHI
20201245476	TRINDADE	10025686150	TRINDADE	09/12/2020 06:04	09/12/2020 11:19	09/12/2020 06:04	09/12/2020 11:19	5,25	1	5,25	CHI
20201245477	CALDAS NOVAS	CN21000057	CALDAS NOVAS S2	09/12/2020 06:04	09/12/2020 09:24	09/12/2020 06:04	09/12/2020 09:24	3,33	1	3,33	CHI
20201245491	APARECIDA DE GOIANIA	10018563846	INDEPENDENCIA S2	09/12/2020 06:05	09/12/2020 07:37	09/12/2020 06:05	09/12/2020 07:37	1,52	1	1,52	CHI
20201245693	FORMOSA	FA32042714	SAO JOAO D ALIANCA	09/12/2020 06:05	09/12/2020 10:48	09/12/2020 06:05	09/12/2020 10:48	4,70	9	42,32	CHI
20201246333	SANCLERLANDIA	SC12206494	SAO LUIZ DOS MONTES BELOS	09/12/2020 06:05	09/12/2020 15:15	09/12/2020 06:05	09/12/2020 15:15	9,17	9	82,50	CHI
20201246333	SAO LUIS DE MONTES BELOS	SC12206494	SAO LUIZ DOS MONTES BELOS	09/12/2020 06:05	09/12/2020 15:15	09/12/2020 06:05	09/12/2020 15:15	9,17	1	9,17	CHI
20201247829	GOIANESIA	GE12080429	GOIANESIA S1	09/12/2020 06:05	09/12/2020 16:25	09/12/2020 06:05	09/12/2020 16:25	10,32	13	134,16	CHI
20201245496	ITAPACI	IW12044978	ITAPACI	09/12/2020 06:06	09/12/2020 10:36	09/12/2020 06:06	09/12/2020 10:36	4,49	6	26,93	CHI
20201245803	PONTALINA	PK12181924	VICENTINOPOLIS	09/12/2020 06:06	09/12/2020 09:05	09/12/2020 06:06	09/12/2020 09:05	2,97	21	62,39	CHI
20201246785	ITABERAI	MD12062634RE	ITABERAI S1	09/12/2020 06:06	09/12/2020 10:37	09/12/2020 06:06	09/12/2020 10:37	4,52	4	18,07	CHI
20201246785	MOSSAMEDES	MD12062634RE	ITABERAI S1	09/12/2020 06:06	09/12/2020 10:37	09/12/2020 06:06	09/12/2020 10:37	4,52	200	903,28	CHI
20201246785	GOIAS	MD12062634RE	ITABERAI S1	09/12/2020 06:06	09/12/2020 10:37	09/12/2020 06:06	09/12/2020 10:37	4,52	7	31,61	CHI
20201245499	GOUVELANDIA	GB21296586	QUIRINOPOLIS	09/12/2020 06:07	09/12/2020 12:11	09/12/2020 06:07	09/12/2020 12:11	6,07	1	6,07	CHI
20201245501	ARAGUAPAZ	1780001542	GOIAS	09/12/2020 06:07	09/12/2020 16:26	09/12/2020 06:07	09/12/2020 16:26	10,31	1	10,31	CHI
20201246366	IPAMERI	IP12376252	CRISTALINA S2	09/12/2020 06:07	09/12/2020 14:12	09/12/2020 06:07	09/12/2020 14:12	8,07	20	161,41	CHI
20201242484	RIO VERDE	RV12301460	ACREUNA	09/12/2020 06:08	09/12/2020 11:20	09/12/2020 06:08	09/12/2020 11:20	5,19	6	31,12	CHI
20201242484	SANTO ANTONIO DA BARRA	RV12301460	ACREUNA	09/12/2020 06:08	09/12/2020 11:20	09/12/2020 06:08	09/12/2020 11:20	5,19	2	10,37	CHI
20201245513	GOIANAPOLIS	GP21022433	DAIA S2	09/12/2020 06:08	09/12/2020 10:27	09/12/2020 06:08	09/12/2020 10:27	4,30	1	4,30	CHI
20201245902	OURO VERDE DE GOIAS	NV12382719	INHUMAS S1	09/12/2020 06:08	09/12/2020 09:14	09/12/2020 06:08	09/12/2020 09:14	3,08	46	141,87	CHI
20201245902	NOVA VENEZA	NV12382719	INHUMAS S1	09/12/2020 06:08	09/12/2020 09:14	09/12/2020 06:08	09/12/2020 09:14	3,08	60	185,05	CHI
20201245519	PARAUNA	PU12307075	PARAUNA	09/12/2020 06:09	09/12/2020 12:35	09/12/2020 06:09	09/12/2020 12:35	6,42	5	32,09	CHI
20201246486	POSSE	PS12237062	IACIARA S2	09/12/2020 06:09	09/12/2020 11:05	09/12/2020 06:09	09/12/2020 11:05	4,93	19	93,59	CHI
20201246780	NOVA CRIXAS	NA12041162	NOVA CRIXAS	09/12/2020 06:09	09/12/2020 17:33	09/12/2020 06:09	09/12/2020 17:33	11,40	29	330,54	CHI
20201246780	MUNDO NOVO DE GOIAS	NA12041162	NOVA CRIXAS	09/12/2020 06:09	09/12/2020 17:33	09/12/2020 06:09	09/12/2020 17:33	11,40	37	421,73	CHI
20201245523	RIO VERDE	RV12123226LD	RIO VERDE S1	09/12/2020 06:10	09/12/2020 20:22	09/12/2020 06:10	09/12/2020 13:04	6,90	15	103,46	CHI
20201245523	RIO VERDE	RV12123226LD	RIO VERDE S1	09/12/2020 06:10	09/12/2020 20:22	09/12/2020 09:50	09/12/2020 13:04	3,24	1	3,24	CHI
20201245523	RIO VERDE	RV12123226LD	RIO VERDE S1	09/12/2020 06:10	09/12/2020 20:22	09/12/2020 06:10	09/12/2020 14:08	7,96	36	286,63	CHI
20201245523	RIO VERDE	RV12123226LD	RIO VERDE S1	09/12/2020 06:10	09/12/2020 20:22	09/12/2020 06:10	09/12/2020 16:41	10,52	8	84,17	CHI
20201245523	RIO VERDE	RV12123226LD	RIO VERDE S1	09/12/2020 06:10	09/12/2020 20:22	09/12/2020 06:10	09/12/2020 16:58	10,80	1	10,80	CHI
20201245523	RIO VERDE	RV12123226LD	RIO VERDE S1	09/12/2020 06:10	09/12/2020 20:22	09/12/2020 06:10	09/12/2020 20:22	14,20	1	14,20	CHI

20201245747	SANTA CRUZ DE GOIAS	BC12389805	PIRES DO RIO S2	09/12/2020 06:10	09/12/2020 23:34	09/12/2020 06:10	09/12/2020 23:34	17,39	9	156,51	CHI
20201245529	LUZIANIA	LZ21313650	MARAJOARA	09/12/2020 06:11	09/12/2020 11:39	09/12/2020 06:11	09/12/2020 11:39	5,46	1	5,46	CHI
20201245542	NIQUELANDIA	NQ21146081	URUACU	09/12/2020 06:12	09/12/2020 11:02	09/12/2020 06:12	09/12/2020 11:02	4,82	1	4,82	CHI
20201245544	GOIANIA	14960977	XAVANTES	09/12/2020 06:12	09/12/2020 09:53	09/12/2020 06:12	09/12/2020 09:53	3,67	1	3,67	CHI
20201247072	CRISTALINA	KR12320036	CRISTALINA S2	09/12/2020 06:12	09/12/2020 14:59	09/12/2020 06:12	09/12/2020 14:59	8,78	11	96,63	CHI
20201245795	SILVANIA	SV12400022	VIANOPOLIS	09/12/2020 06:13	09/12/2020 10:04	09/12/2020 06:13	09/12/2020 10:04	3,83	27	103,53	CHI
20201246170	GOIAS	GS12070348	GOIAS	09/12/2020 06:13	09/12/2020 12:15	09/12/2020 06:13	09/12/2020 12:15	6,03	6	36,18	CHI
20201248550	MARA ROSA	MQ12295280	MARA ROSA	09/12/2020 06:13	09/12/2020 17:23	09/12/2020 06:13	09/12/2020 17:23	11,16	4	44,62	CHI
20201247556	SANCLERLANDIA	SC12383552	FIRMINOPOLIS S2	09/12/2020 06:14	09/12/2020 14:35	09/12/2020 06:14	09/12/2020 14:35	8,35	11	91,84	CHI
20201252248	JATAI	JT21211319	JATAI S1	09/12/2020 06:14	09/12/2020 21:45	09/12/2020 06:14	09/12/2020 21:45	15,52	1	15,52	CHI
20201245564	PORANGATU	TA12114216	NOVO PLANALTO	09/12/2020 06:15	09/12/2020 09:07	09/12/2020 06:15	09/12/2020 09:07	2,86	6	17,13	CHI
20201246291	INHUMAS	IN11000045	INHUMAS S2	09/12/2020 06:15	09/12/2020 19:46	09/12/2020 06:15	09/12/2020 19:46	13,50	105	1417,82	CHI
20201248369	URUACU	HL12003223RE	SANTA TEREZINHA	09/12/2020 06:15	09/12/2020 15:27	09/12/2020 06:15	09/12/2020 15:27	9,19	4	36,78	CHI
20201248369	HIDROLINA	HL12003223RE	SANTA TEREZINHA	09/12/2020 06:15	09/12/2020 15:27	09/12/2020 06:15	09/12/2020 15:27	9,19	1	9,19	CHI
20201248369	PILAR DE GOIAS	HL12003223RE	SANTA TEREZINHA	09/12/2020 06:15	09/12/2020 15:27	09/12/2020 06:15	09/12/2020 15:27	9,19	49	450,54	CHI
20201237893	DOVERLANDIA	MY12219553LD	PARQUE DAS EMAS	09/12/2020 06:16	11/12/2020 18:43	09/12/2020 06:16	10/12/2020 14:28	32,19	8	257,54	CHI
20201237893	DOVERLANDIA	MY12219553LD	PARQUE DAS EMAS	09/12/2020 06:16	11/12/2020 18:43	09/12/2020 06:16	11/12/2020 18:43	60,44	38	2296,85	CHI
20201245567	JATAI	JT21105473	JATAI S1	09/12/2020 06:16	09/12/2020 21:08	09/12/2020 06:16	09/12/2020 21:08	14,86	1	14,86	CHI
20201245574	MINACU	4020049477	MINACU	09/12/2020 06:16	09/12/2020 16:46	09/12/2020 06:16	09/12/2020 16:46	10,48	1	10,48	CHI
20201245971	NOVA CRIXAS	NA12035650	NOVA CRIXAS	09/12/2020 06:16	09/12/2020 08:55	09/12/2020 06:16	09/12/2020 08:55	2,63	24	63,22	CHI
20201245971	MUNDO NOVO DE GOIAS	NA12035650	NOVA CRIXAS	09/12/2020 06:16	09/12/2020 08:55	09/12/2020 06:16	09/12/2020 08:55	2,63	8	21,07	CHI
20201246016	ITABERAI	IB16407964	ITABERAI S2	09/12/2020 06:16	09/12/2020 12:54	09/12/2020 06:16	09/12/2020 09:37	3,35	578	1937,42	CHI
20201246016	ITABERAI	IB16408092	ITABERAI S2	09/12/2020 06:16	09/12/2020 12:54	09/12/2020 06:16	09/12/2020 10:00	3,73	426	1590,40	CHI
20201246016	GOIAS	00880234	ITABERAI S2	09/12/2020 06:16	09/12/2020 12:54	09/12/2020 10:49	09/12/2020 10:54	0,08	108	8,25	CHI
20201246016	ITABERAI	00880234	ITABERAI S2	09/12/2020 06:16	09/12/2020 12:54	09/12/2020 10:49	09/12/2020 10:54	0,08	1227	93,73	CHI
20201246016	MOSSAMEDES	00880234	ITABERAI S2	09/12/2020 06:16	09/12/2020 12:54	09/12/2020 10:49	09/12/2020 10:54	0,08	228	17,42	CHI
20201246016	ITABERAI	00880234	ITABERAI S2	09/12/2020 06:16	09/12/2020 12:54	09/12/2020 10:49	09/12/2020 10:54	0,08	3192	243,83	CHI
20201246016	MOSSAMEDES	IB16408092	ITABERAI S2	09/12/2020 06:16	09/12/2020 12:54	09/12/2020 10:50	09/12/2020 10:54	0,07	18	1,24	CHI
20201246016	ITABERAI	IB10406889	ITABERAI S2	09/12/2020 06:16	09/12/2020 12:54	09/12/2020 10:49	09/12/2020 10:54	0,09	426	36,80	CHI
20201246016	ITABERAI	IB16408092	ITABERAI S2	09/12/2020 06:16	09/12/2020 12:54	09/12/2020 10:49	09/12/2020 10:55	0,10	578	55,71	CHI
20201246016	ITABERAI	IB16407964	ITABERAI S2	09/12/2020 06:16	09/12/2020 12:54	09/12/2020 10:49	09/12/2020 10:55	0,10	4603	464,14	CHI
20201246016	ITABERAI	IB16409799	ITABERAI S2	09/12/2020 06:16	09/12/2020 12:54	09/12/2020 10:49	09/12/2020 12:25	1,60	321	513,60	CHI
20201246016	ITABERAI	IB12000008	ITABERAI S2	09/12/2020 06:16	09/12/2020 12:54	09/12/2020 06:16	09/12/2020 12:53	6,62	542	3589,24	CHI
20201246016	ITABERAI	IB11220456	ITABERAI S2	09/12/2020 06:16	09/12/2020 12:54	09/12/2020 10:49	09/12/2020 12:54	2,07	158	327,19	CHI
20201246277	GOIAS	00880434	ITABERAI S1	09/12/2020 06:16	09/12/2020 16:22	09/12/2020 09:53	09/12/2020 10:04	0,18	44	7,77	CHI
20201246277	ITABERAI	00880434	ITABERAI S1	09/12/2020 06:16	09/12/2020 16:22	09/12/2020 09:53	09/12/2020 10:04	0,18	67	11,84	CHI
20201246277	GOIAS	GS12310470	ITABERAI S1	09/12/2020 06:16	09/12/2020 16:22	09/12/2020 06:16	09/12/2020 16:22	10,10	3	30,30	CHI
20201246755	GOIATUBA	GT12392084	GOIATUBA S2	09/12/2020 06:16	12/12/2020 13:15	09/12/2020 06:16	09/12/2020 13:50	7,55	3	22,65	CHI
20201246755	GOIATUBA	GT12392084	GOIATUBA S2	09/12/2020 06:16	12/12/2020 13:15	09/12/2020 09:25	09/12/2020 13:50	4,42	1	4,42	CHI
20201246755	GOIATUBA	GT12392084	GOIATUBA S2	09/12/2020 06:16	12/12/2020 13:15	09/12/2020 17:42	09/12/2020 18:28	0,76	4	3,05	CHI
20201246755	GOIATUBA	GT12392084	GOIATUBA S2	09/12/2020 06:16	12/12/2020 13:15	10/12/2020 11:41	10/12/2020 13:03	1,36	4	5,42	CHI
20201246755	GOIATUBA	GT12392084	GOIATUBA S2	09/12/2020 06:16	12/12/2020 13:15	09/12/2020 06:16	11/12/2020 09:34	51,29	2	102,57	CHI
20201246755	GOIATUBA	GT12392084	GOIATUBA S2	09/12/2020 06:16	12/12/2020 13:15	11/12/2020 09:35	11/12/2020 10:52	1,28	4	5,13	CHI
20201246755	GOIATUBA	GT12273783	GOIATUBA S2	09/12/2020 06:16	12/12/2020 13:15	11/12/2020 16:45	11/12/2020 20:59	4,24	34	144,12	CHI
20201246755	GOIATUBA	GT12392084	GOIATUBA S2	09/12/2020 06:16	12/12/2020 13:15	09/12/2020 06:16	12/12/2020 12:41	78,40	12	940,81	CHI
20201246755	GOIATUBA	GT12392084	GOIATUBA S2	09/12/2020 06:16	12/12/2020 13:15	11/12/2020 09:35	12/12/2020 12:41	27,09	2	54,18	CHI
20201246755	GOIATUBA	GT12392084	GOIATUBA S2	09/12/2020 06:16	12/12/2020 13:15	09/12/2020 06:16	12/12/2020 13:15	78,98	1	78,98	CHI
20201245579	APARECIDA DE GOIANIA	15271109	INDEPENDENCIA S1	09/12/2020 06:17	09/12/2020 08:39	09/12/2020 06:17	09/12/2020 08:39	2,36	1	2,36	CHI
20201246640	NIQUELANDIA	NQ11243529	BARRO ALTO	09/12/2020 06:17	09/12/2020 10:45	09/12/2020 06:17	09/12/2020 10:45	4,46	128	571,24	CHI
20201245584	ARAGOIANIA	10020177648	GUAPO S2	09/12/2020 06:18	09/12/2020 11:22	09/12/2020 06:18	09/12/2020 11:22	5,07	1	5,07	CHI
20201245590	BRITANIA	BT11252613	BRITANIA	09/12/2020 06:18	09/12/2020 10:40	09/12/2020 06:18	09/12/2020 10:40	4,36	87	379,03	CHI

20201245593	SANCLERLANDIA	SL12323584	SAO LUIZ DOS MONTES BELOS	09/12/2020 06:18	09/12/2020 13:10	09/12/2020 06:18	09/12/2020 10:24	4,09	18	73,56	CHI
20201245593	SANCLERLANDIA	SC21323852	SAO LUIZ DOS MONTES BELOS	09/12/2020 06:18	09/12/2020 13:10	09/12/2020 06:18	09/12/2020 13:10	6,87	1	6,87	CHI
20201245594	JATAI	JT21000217	JATAI S1	09/12/2020 06:18	09/12/2020 12:27	09/12/2020 06:18	09/12/2020 12:27	6,14	1	6,14	CHI
20201245608	URUACU	UR10408084	URUACU	09/12/2020 06:18	09/12/2020 17:10	09/12/2020 06:18	09/12/2020 07:59	1,68	81	136,01	CHI
20201245608	URUACU	UR10408084	URUACU	09/12/2020 06:18	09/12/2020 17:10	09/12/2020 08:05	09/12/2020 09:23	1,30	12	15,60	CHI
20201245608	NOVA IGUACU DE GOIAS	UR12050050LD	URUACU	09/12/2020 06:18	09/12/2020 17:10	09/12/2020 06:18	09/12/2020 11:05	4,78	20	95,53	CHI
20201245608	URUACU	UR12050050LD	URUACU	09/12/2020 06:18	09/12/2020 17:10	09/12/2020 06:18	09/12/2020 11:05	4,78	84	401,22	CHI
20201245608	PILAR DE GOIAS	UR12050050LD	URUACU	09/12/2020 06:18	09/12/2020 17:10	09/12/2020 06:18	09/12/2020 11:05	4,78	1	4,78	CHI
20201245608	URUACU	UR12050050LD	URUACU	09/12/2020 06:18	09/12/2020 17:10	09/12/2020 08:05	09/12/2020 11:05	3,00	43	128,92	CHI
20201245608	PILAR DE GOIAS	UR12050050LD	URUACU	09/12/2020 06:18	09/12/2020 17:10	09/12/2020 11:51	09/12/2020 12:05	0,23	1	0,23	CHI
20201245608	NOVA IGUACU DE GOIAS	UR12050050LD	URUACU	09/12/2020 06:18	09/12/2020 17:10	09/12/2020 11:51	09/12/2020 12:05	0,23	21	4,83	CHI
20201245608	URUACU	UR12050050LD	URUACU	09/12/2020 06:18	09/12/2020 17:10	09/12/2020 11:51	09/12/2020 12:05	0,23	127	29,21	CHI
20201245608	URUACU	UR12088739	URUACU	09/12/2020 06:18	09/12/2020 17:10	09/12/2020 08:05	09/12/2020 14:31	6,43	7	45,04	CHI
20201245608	URUACU	UR12117971	URUACU	09/12/2020 06:18	09/12/2020 17:10	09/12/2020 08:05	09/12/2020 15:45	7,67	12	92,03	CHI
20201245608	URUACU	UR12213186LD	URUACU	09/12/2020 06:18	09/12/2020 17:10	09/12/2020 08:05	09/12/2020 16:49	8,73	1	8,73	CHI
20201245608	URUACU	UR12278481	URUACU	09/12/2020 06:18	09/12/2020 17:10	09/12/2020 08:05	09/12/2020 17:10	9,09	6	54,57	CHI
20201245732	PARAUNA	PU12391518	PARAUNA	09/12/2020 06:18	09/12/2020 14:29	09/12/2020 06:18	09/12/2020 14:29	8,18	26	212,77	CHI
20201245769	ALTO HORIZONTE	AJ12321045	SANTA TEREZINHA	09/12/2020 06:18	09/12/2020 10:40	09/12/2020 06:18	09/12/2020 10:40	4,35	16	69,67	CHI
20201245802	NOVA IGUACU DE GOIAS	CR12070384	CAMPINORTE	09/12/2020 06:18	09/12/2020 11:11	09/12/2020 06:18	09/12/2020 11:11	4,88	23	112,18	CHI
20201245802	CAMPINORTE	CR12070384	CAMPINORTE	09/12/2020 06:18	09/12/2020 11:11	09/12/2020 06:18	09/12/2020 11:11	4,88	8	39,02	CHI
20201245597	PANAMA	GT12000264	GOIATUBA S1	09/12/2020 06:19	09/12/2020 10:07	09/12/2020 06:19	09/12/2020 10:07	3,80	1	3,80	CHI
20201245597	GOIATUBA	GT12000264	GOIATUBA S1	09/12/2020 06:19	09/12/2020 10:07	09/12/2020 06:19	09/12/2020 10:07	3,80	16	60,79	CHI
20201245597	RUBIATABA	GT12000264	GOIATUBA S1	09/12/2020 06:19	09/12/2020 10:07	09/12/2020 06:19	09/12/2020 10:07	3,80	1	3,80	CHI
20201245599	NOVO BRASIL	NB21188115	JUSSARA	09/12/2020 06:19	10/12/2020 09:06	09/12/2020 06:19	10/12/2020 09:06	26,78	1	26,78	CHI
20201245604	SANTA ROSA DE GOIAS	SR12019009	INHUMAS S1	09/12/2020 06:19	09/12/2020 11:42	09/12/2020 06:19	09/12/2020 11:42	5,37	47	252,59	CHI
20201245604	TAQUARAL DE GOIAS	SR12019009	INHUMAS S1	09/12/2020 06:19	09/12/2020 11:42	09/12/2020 06:19	09/12/2020 11:42	5,37	26	139,73	CHI
20201245607	MINEIROS	1390168776	PARQUE DAS EMAS	09/12/2020 06:19	09/12/2020 15:16	09/12/2020 06:19	09/12/2020 15:16	8,94	1	8,94	CHI
20201246105	PETROLINA DE GOIAS	PG12048641	PETROLINA	09/12/2020 06:19	09/12/2020 15:55	09/12/2020 06:19	09/12/2020 15:55	9,59	19	182,21	CHI
20201246085	GOIANIRA	GR12015741LD	INHUMAS S1	09/12/2020 06:20	09/12/2020 15:05	09/12/2020 06:20	09/12/2020 15:05	8,73	5	43,67	CHI
20201246855	PORANGATU	BX12292422	SAO MIGUEL DO ARAGUAIA	09/12/2020 06:20	09/12/2020 13:57	09/12/2020 06:20	09/12/2020 13:57	7,62	1	7,62	CHI
20201246855	BONOPOLIS	BX12292422	SAO MIGUEL DO ARAGUAIA	09/12/2020 06:20	09/12/2020 13:57	09/12/2020 06:20	09/12/2020 13:57	7,62	32	243,70	CHI
20201245620	COCALZINHO DE GOIAS	ZN12185681	COCALZINHO	09/12/2020 06:21	09/12/2020 12:10	09/12/2020 06:21	09/12/2020 12:10	5,81	6	34,84	CHI
20201245620	PIRENOPOLIS	ZN12185681	COCALZINHO	09/12/2020 06:21	09/12/2020 12:10	09/12/2020 06:21	09/12/2020 12:10	5,81	5	29,04	CHI
20201250262	NOVA CRIXAS	NA12090020	NOVA CRIXAS	09/12/2020 06:21	09/12/2020 18:27	09/12/2020 06:21	09/12/2020 18:27	12,10	12	145,20	CHI
20201245781	MONTIVIDIU	MV12340904	MONTIVIDIU T	09/12/2020 06:22	09/12/2020 08:47	09/12/2020 06:22	09/12/2020 08:47	2,41	14	33,76	CHI
20201245781	CAIAPONIA	MV12340904	MONTIVIDIU T	09/12/2020 06:22	09/12/2020 08:47	09/12/2020 06:22	09/12/2020 08:47	2,41	1	2,41	CHI
20201245937	AVELINOPOLIS	AV11020315	ANICUNS	09/12/2020 06:22	09/12/2020 10:23	09/12/2020 06:22	09/12/2020 10:23	4,00	128	512,50	CHI
20201246003	ARENOPOLIS	AY12345509	ARENOPOLIS	09/12/2020 06:22	09/12/2020 11:34	09/12/2020 06:22	09/12/2020 11:34	5,19	9	46,68	CHI
20201246448	PARANAIGUARA	PC13214178	QUIRINOPOLIS	09/12/2020 06:22	09/12/2020 22:10	09/12/2020 16:04	09/12/2020 19:05	3,03	31	93,88	CHI
20201246448	PARANAIGUARA	PC12271707	QUIRINOPOLIS	09/12/2020 06:22	09/12/2020 22:10	09/12/2020 06:22	09/12/2020 22:10	15,80	5	79,00	CHI
20201247154	ITAGUARU	IC12065281	ITABERAI S1	09/12/2020 06:22	09/12/2020 14:57	09/12/2020 06:22	09/12/2020 14:57	8,58	3	25,75	CHI
20201247154	HEITORAI	IC12065281	ITABERAI S1	09/12/2020 06:22	09/12/2020 14:57	09/12/2020 06:22	09/12/2020 14:57	8,58	7	60,07	CHI
20201245636	NOVA CRIXAS	NA12038063	MOZARLANDIA	09/12/2020 06:23	09/12/2020 13:55	09/12/2020 06:23	09/12/2020 13:55	7,52	7	52,64	CHI
20201245899	FORMOSA	FA12207282	ITUIQUIRA	09/12/2020 06:23	09/12/2020 12:28	09/12/2020 06:23	09/12/2020 12:28	6,08	14	85,10	CHI
20201246019	GOIAS	GS12274373	GOIAS	09/12/2020 06:23	09/12/2020 09:08	09/12/2020 06:23	09/12/2020 09:08	2,74	12	32,83	CHI
20201246107	RIO VERDE	RV12098526	MONTIVIDIU T	09/12/2020 06:23	09/12/2020 17:59	09/12/2020 06:23	09/12/2020 17:59	11,58	3	34,75	CHI
20201247360	BOM JESUS DE GOIAS	BJ12392118	BOM JESUS DE GOIAS	09/12/2020 06:24	09/12/2020 12:01	09/12/2020 06:24	09/12/2020 12:01	5,60	3	16,81	CHI
20201245654	TRINDADE	10032380788	TRINDADE	09/12/2020 06:25	09/12/2020 11:06	09/12/2020 06:25	09/12/2020 11:06	4,67	1	4,67	CHI
20201245656	MORRINHOS	MR12000166	MORRINHOS	09/12/2020 06:26	09/12/2020 07:27	09/12/2020 06:26	09/12/2020 07:27	1,01	4	4,04	CHI
20201245658	GOIAS	GS12070358	GOIAS	09/12/2020 06:26	09/12/2020 10:08	09/12/2020 06:26	09/12/2020 10:08	3,69	9	33,23	CHI
20201246405	URUACU	UR12333892	URUACU	09/12/2020 06:26	09/12/2020 16:52	09/12/2020 06:26	09/12/2020 16:52	10,43	13	135,55	CHI

20201246651	COCALZINHO DE GOIAS	ZN12284337	COCALZINHO	09/12/2020 06:26	10/12/2020 19:17	09/12/2020 06:26	10/12/2020 19:17	36,83	6	221,00	CHI
20201247060	BALIZA	BH12358780	BOM JARDIM	09/12/2020 06:26	09/12/2020 09:20	09/12/2020 06:26	09/12/2020 09:20	2,89	15	43,33	CHI
20201246551	IPAMERI	IP12287085	IPAMERI	09/12/2020 06:27	09/12/2020 10:29	09/12/2020 06:27	09/12/2020 10:29	4,03	24	96,69	CHI
20201245677	CACU	CC21142030	CACHOEIRA ALTA	09/12/2020 06:28	09/12/2020 07:33	09/12/2020 06:28	09/12/2020 07:33	1,08	1	1,08	CHI
20201245683	EDEIA	EA12257964	EDEIA	09/12/2020 06:28	09/12/2020 15:25	09/12/2020 06:28	09/12/2020 15:25	8,94	1	8,94	CHI
20201246028	CACHOEIRA DE GOIAS	CG12087363	FIRMINOPOLIS S2	09/12/2020 06:28	09/12/2020 18:21	09/12/2020 06:28	09/12/2020 18:21	11,89	20	237,87	CHI
20201246104	NOVA CRIXAS	NA12380421	NOVA CRIXAS	09/12/2020 06:28	09/12/2020 11:01	09/12/2020 06:28	09/12/2020 11:01	4,55	49	222,87	CHI
20201246307	SAO LUIS DE MONTES BELOS	SC12213411	FIRMINOPOLIS S2	09/12/2020 06:28	09/12/2020 19:28	09/12/2020 06:28	09/12/2020 19:28	12,99	2	25,97	CHI
20201246307	SANCLERLANDIA	SC12213411	FIRMINOPOLIS S2	09/12/2020 06:28	09/12/2020 19:28	09/12/2020 06:28	09/12/2020 19:28	12,99	43	558,44	CHI
20201247001	NIQUELANDIA	NQ12227348	URUACU	09/12/2020 06:28	09/12/2020 11:08	09/12/2020 06:28	09/12/2020 11:08	4,66	45	209,58	CHI
20201250439	SANTA CRUZ DE GOIAS	BC12389804	PIRES DO RIO S2	09/12/2020 06:28	09/12/2020 21:44	09/12/2020 06:28	09/12/2020 21:44	15,27	22	335,85	CHI
20201245691	UIRAPURU	4200002578	SANTA TEREZINHA	09/12/2020 06:29	09/12/2020 07:53	09/12/2020 06:29	09/12/2020 07:53	1,39	1	1,39	CHI
20201245699	GUARAITA	GK12299340	ITAPURANGA	09/12/2020 06:29	09/12/2020 10:48	09/12/2020 06:29	09/12/2020 10:48	4,31	22	94,77	CHI
20201245697	FORMOSA	FA21120086	ITQUIRA	09/12/2020 06:30	09/12/2020 12:05	09/12/2020 06:30	09/12/2020 12:05	5,58	1	5,58	CHI
20201246050	ANAPOLIS	NR12402742	NEROPOLIS S2	09/12/2020 06:30	09/12/2020 11:07	09/12/2020 06:30	09/12/2020 11:07	4,61	8	36,89	CHI
20201245701	GOIATUBA	BJ12030824	RIO DOS BOIS	09/12/2020 06:31	09/12/2020 21:02	09/12/2020 06:31	09/12/2020 21:02	14,51	2	29,03	CHI
20201245705	NIQUELANDIA	NQ12293890	URUACU	09/12/2020 06:31	09/12/2020 12:52	09/12/2020 06:31	09/12/2020 12:52	6,34	2	12,67	CHI
20201245715	PORANGATU	PO12265821	PORANGATU	09/12/2020 06:31	09/12/2020 16:34	09/12/2020 06:31	09/12/2020 16:34	10,04	5	50,19	CHI
20201246304	GOIANIA	GN12000886	GOIANIA LESTE S2	09/12/2020 06:31	09/12/2020 08:40	09/12/2020 06:31	09/12/2020 08:40	2,16	709	1530,26	CHI
20201245710	PILAR DE GOIAS	GG12094182	SANTA TEREZINHA	09/12/2020 06:32	10/12/2020 00:15	09/12/2020 06:32	10/12/2020 00:15	17,71	1	17,71	CHI
20201246119	PIRACANJUBA	PJ12020064	MORRINHOS	09/12/2020 06:34	10/12/2020 03:01	09/12/2020 06:34	10/12/2020 03:01	20,44	15	306,65	CHI
20201246302	FORMOSA	FA12248883	ITQUIRA	09/12/2020 06:34	09/12/2020 13:51	09/12/2020 06:34	09/12/2020 13:51	7,27	17	123,62	CHI
20201247340	MAURILANDIA	CL12306027	RIO DOS BOIS	09/12/2020 06:34	09/12/2020 19:12	09/12/2020 06:34	09/12/2020 19:12	12,64	5	63,19	CHI
20201247340	PORTEIRAO	CL12306027	RIO DOS BOIS	09/12/2020 06:34	09/12/2020 19:12	09/12/2020 06:34	09/12/2020 19:12	12,64	3	37,92	CHI
20201245725	CAMPO ALEGRE DE GOIAS	CM12142253	CAMPO ALEGRE DE GOIAS	09/12/2020 06:35	09/12/2020 12:02	09/12/2020 06:35	09/12/2020 12:02	5,44	4	21,76	CHI
20201245727	JATAI	JT21138161	JATAI S1	09/12/2020 06:35	09/12/2020 21:58	09/12/2020 06:35	09/12/2020 21:58	15,37	1	15,37	CHI
20201245730	UIRAPURU	SG12318464	SANTA TEREZINHA	09/12/2020 06:35	09/12/2020 21:21	09/12/2020 06:35	09/12/2020 21:21	14,75	14	206,53	CHI
20201245730	CAMPOS VERDES	SG12318464	SANTA TEREZINHA	09/12/2020 06:35	09/12/2020 21:21	09/12/2020 06:35	09/12/2020 21:21	14,75	13	191,78	CHI
20201245730	SANTA TEREZINHA DE GOIAS	SG12318464	SANTA TEREZINHA	09/12/2020 06:35	09/12/2020 21:21	09/12/2020 06:35	09/12/2020 21:21	14,75	35	516,33	CHI
20201246821	INDIARA	IY12158916	CEZARINA	09/12/2020 06:35	09/12/2020 14:08	09/12/2020 06:35	09/12/2020 14:08	7,54	2	15,08	CHI
20201245736	NIQUELANDIA	NQ11162603	NIQUELANDIA SUBTRANSMISSAO	09/12/2020 06:36	09/12/2020 11:30	09/12/2020 06:36	09/12/2020 11:30	4,89	22	107,54	CHI
20201247013	MINEIROS	MY12202613RE	PARQUE DAS EMAS	09/12/2020 06:36	09/12/2020 13:40	09/12/2020 06:36	09/12/2020 13:40	7,06	10	70,61	CHI
20201245742	ITABERAI	IB21379738	ITABERAI S1	09/12/2020 06:37	10/12/2020 04:29	09/12/2020 06:37	10/12/2020 04:29	21,85	2	43,71	CHI
20201246183	HEITORAI	HE12346692	GOIAS	09/12/2020 06:37	09/12/2020 14:23	09/12/2020 06:37	09/12/2020 14:23	7,76	29	224,97	CHI
20201244036	FORMOSA	O2590206	ITQUIRA	09/12/2020 06:38	09/12/2020 10:40	09/12/2020 06:38	09/12/2020 10:40	4,03	579	2334,82	CHI
20201244036	VILA BOA	O2590206	ITQUIRA	09/12/2020 06:38	09/12/2020 10:40	09/12/2020 06:38	09/12/2020 10:40	4,03	5	20,16	CHI
20201244036	SAO JOAO D ALIANCA	O2590206	ITQUIRA	09/12/2020 06:38	09/12/2020 10:40	09/12/2020 06:38	09/12/2020 10:40	4,03	229	923,44	CHI
20201244036	FLORES DE GOIAS	O2590206	ITQUIRA	09/12/2020 06:38	09/12/2020 10:40	09/12/2020 06:38	09/12/2020 10:40	4,03	3	12,10	CHI
20201245750	PILAR DE GOIAS	GG12171812	SANTA TEREZINHA	09/12/2020 06:38	09/12/2020 17:15	09/12/2020 06:38	09/12/2020 13:15	6,62	4	26,49	CHI
20201245750	PILAR DE GOIAS	GG12171816LD	SANTA TEREZINHA	09/12/2020 06:38	09/12/2020 17:15	09/12/2020 06:38	09/12/2020 17:15	10,63	2	21,25	CHI
20201245752	ITAPURANGA	IK12071747	ITAPURANGA	09/12/2020 06:38	09/12/2020 11:54	09/12/2020 06:38	09/12/2020 11:54	5,26	55	289,27	CHI
20201245755	CAMPINORTE	FO21071183	PORANGATU	09/12/2020 06:38	09/12/2020 08:12	09/12/2020 06:38	09/12/2020 08:12	1,55	2	3,11	CHI
20201248113	OURO VERDE DE GOIAS	OV12319823	NEROPOLIS S1	09/12/2020 06:38	09/12/2020 12:00	09/12/2020 06:38	09/12/2020 12:00	5,36	24	128,53	CHI
20201246014	SANTA TEREZINHA DE GOIAS	SG12202092	SANTA TEREZINHA	09/12/2020 06:39	09/12/2020 09:07	09/12/2020 06:39	09/12/2020 09:07	2,46	6	14,77	CHI
20201246840	GOIANESIA	GE12000180	GOIANESIA S2	09/12/2020 06:39	09/12/2020 12:11	09/12/2020 06:39	09/12/2020 12:11	5,52	22	121,46	CHI
20201247614	VILA PROPICIO	PV12102018	GOIANESIA S1	09/12/2020 06:39	09/12/2020 18:52	09/12/2020 06:39	09/12/2020 18:52	12,21	4	48,85	CHI
20201245768	APARECIDA DE GOIANIA	AP11141264	ANHANGUERA	09/12/2020 06:40	09/12/2020 10:04	09/12/2020 06:40	09/12/2020 10:04	3,39	95	322,52	CHI
20201246200	CAVALCANTE	CJ12278451	NIQUELANDIA SUBTRANSMISSAO	09/12/2020 06:40	09/12/2020 23:01	09/12/2020 06:40	09/12/2020 23:01	16,36	57	932,27	CHI
20201246330	CALDAS NOVAS	CN11128570	SERRA DE CALDAS	09/12/2020 06:40	09/12/2020 08:42	09/12/2020 06:40	09/12/2020 08:42	2,03	108	219,45	CHI
20201245773	ARACU	AV12272362	ANICUNS	09/12/2020 06:41	09/12/2020 11:23	09/12/2020 06:41	09/12/2020 11:23	4,69	4	18,76	CHI
20201245773	ITABERAI	AV12272362	ANICUNS	09/12/2020 06:41	09/12/2020 11:23	09/12/2020 06:41	09/12/2020 11:23	4,69	17	79,75	CHI

20201245850	GOIAS	GS12085888	GOIAS	09/12/2020 06:41	09/12/2020 12:12	09/12/2020 06:41	09/12/2020 12:12	5,50	23	126,56	CHI
20201245779	ALTO PARAISO DE GOIAS	BF21196476	SAO JOAO D ALIANCA	09/12/2020 06:42	09/12/2020 11:54	09/12/2020 06:42	09/12/2020 11:54	5,20	1	5,20	CHI
20201245787	SILVANIA	SV12194949	VIANOPOLIS	09/12/2020 06:42	09/12/2020 23:09	09/12/2020 15:10	09/12/2020 15:45	0,58	83	48,37	CHI
20201245787	SILVANIA	SV12194949	VIANOPOLIS	09/12/2020 06:42	09/12/2020 23:09	09/12/2020 15:10	09/12/2020 23:09	7,98	16	127,75	CHI
20201245797	SENADOR CANEDO	10012409500	SENADOR CANEDO	09/12/2020 06:44	09/12/2020 08:25	09/12/2020 06:44	09/12/2020 08:25	1,67	1	1,67	CHI
20201245799	AURILANDIA	1010002524	FIRMINOPOLIS S2	09/12/2020 06:44	09/12/2020 23:31	09/12/2020 06:44	09/12/2020 23:31	16,77	1	16,77	CHI
20201246139	SANTA ROSA DE GOIAS	SR12078211	INHUMAS S1	09/12/2020 06:44	10/12/2020 10:39	09/12/2020 06:44	10/12/2020 10:39	27,91	4	111,64	CHI
20201250453	PETROLINA DE GOIAS	PG12298071	PETROLINA	09/12/2020 06:44	09/12/2020 22:47	09/12/2020 06:44	09/12/2020 22:47	16,04	31	497,35	CHI
20201250453	SAO FRANCISCO DE GOIAS	PG12298071	PETROLINA	09/12/2020 06:44	09/12/2020 22:47	09/12/2020 06:44	09/12/2020 22:47	16,04	1	16,04	CHI
20201245807	SAO LUIS DE MONTES BELOS	SL11167168	SAO LUIZ DOS MONTES BELOS	09/12/2020 06:46	09/12/2020 12:31	09/12/2020 06:46	09/12/2020 12:31	5,75	84	482,86	CHI
20201245809	DOVERLANDIA	DV21187348	CAIAPONIA	09/12/2020 06:46	09/12/2020 23:58	09/12/2020 06:46	09/12/2020 23:58	17,20	1	17,20	CHI
20201245816	JATAI	JT12306448RE	JATAI S1	09/12/2020 06:46	09/12/2020 08:29	09/12/2020 06:46	09/12/2020 08:29	1,70	16	27,22	CHI
20201249213	SAO LUIZ DO NORTE	GE12382134	BARRO ALTO	09/12/2020 06:46	09/12/2020 22:05	09/12/2020 06:46	09/12/2020 22:05	15,30	4	61,21	CHI
20201249213	HIDROLINA	GE12382134	BARRO ALTO	09/12/2020 06:46	09/12/2020 22:05	09/12/2020 06:46	09/12/2020 22:05	15,30	1	15,30	CHI
20201245819	PIRENOPOLIS	PV12273422	CORUMBA	09/12/2020 06:47	09/12/2020 10:31	09/12/2020 06:47	09/12/2020 10:31	3,73	5	18,64	CHI
20201245823	BRAZABRANTES	BR11199248	INHUMAS S2	09/12/2020 06:48	09/12/2020 08:47	09/12/2020 06:48	09/12/2020 08:47	1,98	55	108,69	CHI
20201245827	GOIANIRA	390034307	GOIANIRA	09/12/2020 06:48	09/12/2020 11:55	09/12/2020 06:48	09/12/2020 11:55	5,10	1	5,10	CHI
20201245829	SANTO ANTONIO DO DESCOBERTO	SN12382973	MARAJOARA	09/12/2020 06:49	09/12/2020 16:51	09/12/2020 06:49	09/12/2020 16:51	10,03	5	50,17	CHI
20201245830	BURITI ALEGRE	BG12254429	ALTO BURITI	09/12/2020 06:49	09/12/2020 10:00	09/12/2020 06:49	09/12/2020 10:00	3,17	1	3,17	CHI
20201244989	ITAPURANGA	IK12387482	ITAPURANGA	09/12/2020 06:50	09/12/2020 10:09	09/12/2020 06:50	09/12/2020 10:09	3,31	45	148,76	CHI
20201245847	POSSE	PS21217892	IACIARA S2	09/12/2020 06:51	09/12/2020 12:33	09/12/2020 06:51	09/12/2020 12:33	5,69	3	17,06	CHI
20201245851	CATALAO	CT21250204	CATALAO S1	09/12/2020 06:51	09/12/2020 10:21	09/12/2020 06:51	09/12/2020 10:21	3,48	1	3,48	CHI
20201247255	CACHOEIRA ALTA	CA12330072	CACHOEIRA ALTA	09/12/2020 06:51	09/12/2020 17:56	09/12/2020 06:51	09/12/2020 17:56	11,08	3	33,25	CHI
20201245927	FAZENDA NOVA	FN11259915	JUSSARA	09/12/2020 06:52	09/12/2020 19:03	09/12/2020 06:52	09/12/2020 19:03	12,18	105	1278,81	CHI
20201245864	APARECIDA DE GOIANIA	11633049	INDEPENDENCIA S2	09/12/2020 06:53	09/12/2020 08:53	09/12/2020 06:53	09/12/2020 08:53	1,99	1	1,99	CHI
20201245865	MARA ROSA	MQ12220617	MARA ROSA	09/12/2020 06:53	09/12/2020 12:19	09/12/2020 06:53	09/12/2020 12:19	5,42	6	32,53	CHI
20201245870	SAO MIGUEL DO ARAGUAIA	SM12298148	SAO MIGUEL DO ARAGUAIA	09/12/2020 06:54	09/12/2020 16:08	09/12/2020 06:54	09/12/2020 16:08	9,23	2	18,46	CHI
20201245872	MONTE ALEGRE DE GOIAS	MA12211597	SAO DOMINGOS	09/12/2020 06:54	09/12/2020 09:54	09/12/2020 06:54	09/12/2020 09:54	2,99	10	29,93	CHI
20201245880	CRISTALINA	IP12100702	CRISTALINA S2	09/12/2020 06:54	09/12/2020 08:46	09/12/2020 06:54	09/12/2020 08:46	1,85	19	35,21	CHI
20201245880	IPAMERI	IP12100702	CRISTALINA S2	09/12/2020 06:54	09/12/2020 08:46	09/12/2020 06:54	09/12/2020 08:46	1,85	14	25,94	CHI
20201245883	AGUA LIMPA	AL21113201	VILA CORUMBA	09/12/2020 06:55	09/12/2020 17:17	09/12/2020 06:55	09/12/2020 17:17	10,37	1	10,37	CHI
20201245947	CALDAS NOVAS	CN11100160	SERRA DE CALDAS	09/12/2020 06:55	09/12/2020 09:39	09/12/2020 06:55	09/12/2020 09:39	2,73	60	163,58	CHI
20201248570	GUARAITA	GS12198785	GOIAS	09/12/2020 06:55	09/12/2020 14:19	09/12/2020 06:55	09/12/2020 14:19	7,39	2	14,78	CHI
20201248570	GOIAS	GS12198785	GOIAS	09/12/2020 06:55	09/12/2020 14:19	09/12/2020 06:55	09/12/2020 14:19	7,39	8	59,12	CHI
20201248570	ITAPURANGA	GS12198785	GOIAS	09/12/2020 06:55	09/12/2020 14:19	09/12/2020 06:55	09/12/2020 14:19	7,39	2	14,78	CHI
20201245892	COCALZINHO DE GOIAS	ZN21293865	COCALZINHO	09/12/2020 06:56	09/12/2020 16:30	09/12/2020 06:56	09/12/2020 16:30	9,56	2	19,12	CHI
20201245894	CACU	1140027340	CACHOEIRA ALTA	09/12/2020 06:56	10/12/2020 16:43	09/12/2020 06:56	10/12/2020 16:43	33,78	1	33,78	CHI
20201245896	FORMOSA	FA31051025	SAO JOAO D ALIANCA	09/12/2020 06:56	10/12/2020 15:23	09/12/2020 06:56	10/12/2020 15:23	32,44	1	32,44	CHI
20201245897	ALVORADA DO NORTE	AQ21268302	IACIARA S2	09/12/2020 06:56	10/12/2020 08:31	09/12/2020 06:56	10/12/2020 08:31	25,57	1	25,57	CHI
20201247937	PARAUNA	JD12310698	PALMEIRAS	09/12/2020 06:56	09/12/2020 12:00	09/12/2020 06:56	09/12/2020 12:00	5,06	16	81,03	CHI
20201245904	GUARAITA	GK12299446	ITAPURANGA	09/12/2020 06:57	09/12/2020 12:17	09/12/2020 06:57	09/12/2020 12:17	5,32	11	58,51	CHI
20201246122	MORRO AGUDO DE GOIAS	RB12292120	RUBIATABA	09/12/2020 06:57	10/12/2020 11:38	09/12/2020 06:57	10/12/2020 11:38	28,68	5	143,38	CHI
20201246122	RUBIATABA	RB12292120	RUBIATABA	09/12/2020 06:57	10/12/2020 11:38	09/12/2020 06:57	10/12/2020 11:38	28,68	4	114,71	CHI
20201243243	CORREGO DO OURO	CO12376358	FIRMINOPOLIS S2	09/12/2020 06:58	09/12/2020 13:32	09/12/2020 06:58	09/12/2020 13:32	6,56	20	131,17	CHI
20201243243	BURITI DE GOIAS	CO12376358	FIRMINOPOLIS S2	09/12/2020 06:58	09/12/2020 13:32	09/12/2020 06:58	09/12/2020 13:32	6,56	32	209,88	CHI
20201245905	CACHOEIRA ALTA	7174486	CACHOEIRA ALTA	09/12/2020 06:58	09/12/2020 11:33	09/12/2020 06:58	09/12/2020 11:33	4,58	1	4,58	CHI
20201246350	OURO VERDE DE GOIAS	OV12326130	NEROPOLIS S2	09/12/2020 06:58	09/12/2020 10:58	09/12/2020 06:58	09/12/2020 10:58	3,99	40	159,70	CHI
20201245911	BELA VISTA DE GOIAS	BV21131429	BELA VISTA S1	09/12/2020 06:59	09/12/2020 09:29	09/12/2020 06:59	09/12/2020 09:29	2,49	2	4,99	CHI
20201245913	ESTRELA DO NORTE	ET21254964	MARA ROSA	09/12/2020 06:59	09/12/2020 10:06	09/12/2020 06:59	09/12/2020 10:06	3,10	1	3,10	CHI
20201246037	ALEXANIA	AX12384864	ALEXANIA	09/12/2020 07:00	10/12/2020 12:55	09/12/2020 07:00	09/12/2020 12:11	5,17	79	408,65	CHI
20201246037	ALEXANIA	AX12384864	ALEXANIA	09/12/2020 07:00	10/12/2020 12:55	09/12/2020 12:21	09/12/2020 18:25	6,07	75	455,23	CHI

20201246037	ALEXANIA	AX12384864	ALEXANIA	09/12/2020 07:00	10/12/2020 12:55	09/12/2020 12:21	10/12/2020 12:55	24,58	4	98,30	CHI
20201246037	ALEXANIA	AX12384864	ALEXANIA	09/12/2020 07:00	10/12/2020 12:55	10/12/2020 11:09	10/12/2020 12:55	1,76	75	132,31	CHI
20201246943	ACREUNA	EU12037883	ACREUNA	09/12/2020 07:00	09/12/2020 13:45	09/12/2020 07:00	09/12/2020 13:45	6,74	6	40,44	CHI
20201247334	LUZIANIA	LZ12370854	MARAJOARA	09/12/2020 07:00	09/12/2020 15:06	09/12/2020 07:00	09/12/2020 15:06	8,08	5	40,42	CHI
20201245925	FAINA	FC12072196	GOIAS	09/12/2020 07:01	09/12/2020 13:10	09/12/2020 07:01	09/12/2020 13:10	6,15	6	36,89	CHI
20201246279	ITABERAI	IB12078567	ITABERAI S1	09/12/2020 07:01	09/12/2020 09:35	09/12/2020 07:01	09/12/2020 09:35	2,56	6	15,39	CHI
20201246279	ITAUCU	IB12078567	ITABERAI S1	09/12/2020 07:01	09/12/2020 09:35	09/12/2020 07:01	09/12/2020 09:35	2,56	1	2,56	CHI
20201247002	CORUMBA DE GOIAS	CB12215044	CORUMBA	09/12/2020 07:01	09/12/2020 12:39	09/12/2020 07:01	09/12/2020 12:39	5,63	23	129,40	CHI
20201247002	PIRENOPOLIS	CB12215044	CORUMBA	09/12/2020 07:01	09/12/2020 12:39	09/12/2020 07:01	09/12/2020 12:39	5,63	2	11,25	CHI
20201245932	MONTÉ ALEGRE DE GOIAS	MA21236772	SAO DOMINGOS	09/12/2020 07:02	09/12/2020 10:55	09/12/2020 07:02	09/12/2020 10:55	3,88	1	3,88	CHI
20201245933	TURVELANDIA	EU21025712	RIO DOS BOIS	09/12/2020 07:02	10/12/2020 07:56	09/12/2020 07:02	10/12/2020 07:56	24,89	1	24,89	CHI
20201246419	CRIXAS	CX12202125	SERRA DO OURO	09/12/2020 07:02	09/12/2020 14:52	09/12/2020 07:02	09/12/2020 14:52	7,82	3	23,46	CHI
20201245939	URUACU	UR12082989	URUACU	09/12/2020 07:03	09/12/2020 11:21	09/12/2020 07:03	09/12/2020 11:21	4,30	6	25,81	CHI
20201245942	ITUMBIARA	BJ12000194	CACHOEIRA DOURADA	09/12/2020 07:03	09/12/2020 11:17	09/12/2020 07:03	09/12/2020 11:17	4,23	5	21,15	CHI
20201245946	BELA VISTA DE GOIAS	BV21000034	BELA VISTA S1	09/12/2020 07:03	09/12/2020 15:20	09/12/2020 07:03	09/12/2020 15:20	8,27	1	8,27	CHI
2020120900029	PETROLINA DE GOIAS	SFG-TR2	SAO FRANCISCO DE GOIAS	09/12/2020 07:03	09/12/2020 08:38	09/12/2020 07:03	09/12/2020 08:38	1,57	13	20,42	CHI
2020120900029	PETROLINA DE GOIAS	SFG-TR2	SAO FRANCISCO DE GOIAS	09/12/2020 07:03	09/12/2020 08:38	09/12/2020 07:03	09/12/2020 08:38	1,57	3	4,71	CHI
2020120900029	JARAGUA	SFG-TR2	SAO FRANCISCO DE GOIAS	09/12/2020 07:03	09/12/2020 08:38	09/12/2020 07:03	09/12/2020 08:38	1,57	22	34,55	CHI
2020120900029	PETROLINA DE GOIAS	SFG-TR2	SAO FRANCISCO DE GOIAS	09/12/2020 07:03	09/12/2020 08:38	09/12/2020 07:03	09/12/2020 08:38	1,57	1	1,57	CHI
2020120900029	PIRENOPOLIS	SFG-TR2	SAO FRANCISCO DE GOIAS	09/12/2020 07:03	09/12/2020 08:38	09/12/2020 07:03	09/12/2020 08:38	1,57	1	1,57	CHI
2020120900029	PIRENOPOLIS	SFG-TR2	SAO FRANCISCO DE GOIAS	09/12/2020 07:03	09/12/2020 08:38	09/12/2020 07:03	09/12/2020 08:38	1,57	335	526,14	CHI
2020120900029	JESUPOLIS	SFG-TR2	SAO FRANCISCO DE GOIAS	09/12/2020 07:03	09/12/2020 08:38	09/12/2020 07:03	09/12/2020 08:38	1,57	156	245,01	CHI
2020120900029	JESUPOLIS	SFG-TR2	SAO FRANCISCO DE GOIAS	09/12/2020 07:03	09/12/2020 08:38	09/12/2020 07:03	09/12/2020 08:38	1,57	955	1499,88	CHI
2020120900029	SAO FRANCISCO DE GOIAS	SFG-TR2	SAO FRANCISCO DE GOIAS	09/12/2020 07:03	09/12/2020 08:38	09/12/2020 07:03	09/12/2020 08:38	1,57	1	1,57	CHI
2020120900029	SAO FRANCISCO DE GOIAS	SFG-TR2	SAO FRANCISCO DE GOIAS	09/12/2020 07:03	09/12/2020 08:38	09/12/2020 07:03	09/12/2020 08:38	1,57	23	36,12	CHI
2020120900029	SAO FRANCISCO DE GOIAS	SFG-TR2	SAO FRANCISCO DE GOIAS	09/12/2020 07:03	09/12/2020 08:38	09/12/2020 07:03	09/12/2020 08:38	1,57	25	39,26	CHI
2020120900029	PIRENOPOLIS	SFG-TR2	SAO FRANCISCO DE GOIAS	09/12/2020 07:03	09/12/2020 08:38	09/12/2020 07:03	09/12/2020 08:38	1,57	1120	1759,02	CHI
2020120900029	SAO FRANCISCO DE GOIAS	SFG-TR2	SAO FRANCISCO DE GOIAS	09/12/2020 07:03	09/12/2020 08:38	09/12/2020 07:03	09/12/2020 08:38	1,57	91	142,92	CHI
2020120900029	PETROLINA DE GOIAS	SFG-TR2	SAO FRANCISCO DE GOIAS	09/12/2020 07:03	09/12/2020 08:38	09/12/2020 07:03	09/12/2020 08:38	1,57	3	4,71	CHI
20201245949	TRINDADE	40036789	TRINDADE	09/12/2020 07:04	09/12/2020 12:27	09/12/2020 07:04	09/12/2020 12:27	5,38	1	5,38	CHI
20201248713	PETROLINA DE GOIAS	PG12061713	PETROLINA	09/12/2020 07:04	10/12/2020 12:06	09/12/2020 07:04	10/12/2020 12:06	29,03	5	145,13	CHI
20201245963	PONTALINA	MR12171699RE	MORRINHOS	09/12/2020 07:05	09/12/2020 10:27	09/12/2020 07:05	09/12/2020 10:27	3,36	5	16,81	CHI
20201245963	MORRINHOS	MR12171699RE	MORRINHOS	09/12/2020 07:05	09/12/2020 10:27	09/12/2020 07:05	09/12/2020 10:27	3,36	27	90,78	CHI
20201245964	LUZIANIA	LZ12261665	MARAJOARA	09/12/2020 07:05	09/12/2020 11:41	09/12/2020 07:05	09/12/2020 11:41	4,59	6	27,57	CHI
20201245970	SANTA CRUZ DE GOIAS	BC11207696	PIRES DO RIO S2	09/12/2020 07:05	09/12/2020 15:11	09/12/2020 07:05	09/12/2020 15:11	8,09	40	323,42	CHI
20201245972	JARAGUA	JA12353217	GOIANESIA S2	09/12/2020 07:06	09/12/2020 13:50	09/12/2020 07:06	09/12/2020 13:50	6,73	7	47,10	CHI
20201246282	DOVERLANDIA	DV12139906	CAIAPONIA	09/12/2020 07:06	10/12/2020 15:13	09/12/2020 07:06	10/12/2020 15:13	32,12	10	321,17	CHI
20201245981	NAZARIO	NZ12000032	ANICUNS	09/12/2020 07:07	09/12/2020 17:53	09/12/2020 07:07	09/12/2020 17:53	10,76	1	10,76	CHI
20201245983	ARAGOIANIA	AO32251689	GUAPU S2	09/12/2020 07:07	09/12/2020 16:53	09/12/2020 07:07	09/12/2020 16:53	9,76	7	68,31	CHI
20201245985	BOM JESUS DE GOIAS	BJ12007756	BOM JESUS DE GOIAS	09/12/2020 07:07	09/12/2020 16:39	09/12/2020 07:07	09/12/2020 16:39	9,52	2	19,04	CHI
20201245986	MINEIROS	MY21303792	PARQUE DAS EMAS	09/12/2020 07:07	09/12/2020 15:07	09/12/2020 07:07	09/12/2020 15:07	7,99	1	7,99	CHI
20201246169	GUARAITA	GK12250513	ITAPURANGA	09/12/2020 07:07	09/12/2020 11:35	09/12/2020 07:07	09/12/2020 11:35	4,47	7	31,26	CHI
20201246498	MOIPORA	MO11201983	IPORA	09/12/2020 07:07	09/12/2020 10:41	09/12/2020 07:07	09/12/2020 10:41	3,57	78	278,14	CHI
20201245988	GOIATUBA	GT12092703	BOM JESUS DE GOIAS	09/12/2020 07:08	09/12/2020 22:41	09/12/2020 07:08	09/12/2020 22:41	15,55	1	15,55	CHI
20201245989	CACHOEIRA ALTA	CA12196143	CACHOEIRA ALTA	09/12/2020 07:08	09/12/2020 20:53	09/12/2020 07:08	09/12/2020 20:53	13,75	2	27,50	CHI
20201245994	JATAI	JT11357068	JATAI S1	09/12/2020 07:08	09/12/2020 21:48	09/12/2020 07:08	09/12/2020 21:48	14,66	1	14,66	CHI
20201245996	PADRE BERNARDO	PB12336085	PADRE BERNARDO	09/12/2020 07:08	09/12/2020 18:00	09/12/2020 07:08	09/12/2020 18:00	10,86	12	130,31	CHI
20201247244	ITAPURANGA	IK11021612	ITAPURANGA	09/12/2020 07:08	09/12/2020 10:39	09/12/2020 07:08	09/12/2020 10:39	3,50	106	371,18	CHI
20201246004	TRINDADE	TR21218030	TRINDADE	09/12/2020 07:09	09/12/2020 15:46	09/12/2020 07:09	09/12/2020 15:46	8,62	1	8,62	CHI
20201246271	URUTAI	UT12375990B	URUTAI	09/12/2020 07:09	09/12/2020 10:27	09/12/2020 07:09	09/12/2020 10:27	3,30	216	712,32	CHI
20201246271	IPAMERI	UT12375990B	URUTAI	09/12/2020 07:09	09/12/2020 10:27	09/12/2020 07:09	09/12/2020 10:27	3,30	54	178,08	CHI

20201246465	ITABERAÍ	IB12206924	ITABERAÍ S2	09/12/2020 07:10	09/12/2020 10:06	09/12/2020 07:10	09/12/2020 10:06	2,92	5	14,62	CHI
20201246017	JATAÍ	JT12365003	JATAÍ S2	09/12/2020 07:11	09/12/2020 18:56	09/12/2020 07:11	09/12/2020 18:56	11,74	2	23,49	CHI
20201246556	TURVANIA	NZ12147519LD	ANICUNS	09/12/2020 07:12	09/12/2020 10:09	09/12/2020 07:12	09/12/2020 10:09	2,94	22	64,66	CHI
20201246556	NAZARIO	NZ12147519LD	ANICUNS	09/12/2020 07:12	09/12/2020 10:09	09/12/2020 07:12	09/12/2020 10:09	2,94	6	17,64	CHI
20201246556	ANICUNS	NZ12147519LD	ANICUNS	09/12/2020 07:12	09/12/2020 10:09	09/12/2020 07:12	09/12/2020 10:09	2,94	50	146,96	CHI
20201246633	PILAR DE GOIAS	GG12181185	SANTA TEREZINHA	09/12/2020 07:12	10/12/2020 14:05	09/12/2020 07:12	10/12/2020 14:05	30,87	27	833,47	CHI
20201247575	ITAPURANGA	IK12220912	ITAPURANGA	09/12/2020 07:12	09/12/2020 13:46	09/12/2020 07:12	09/12/2020 13:46	6,55	7	45,86	CHI
20201246041	APARECIDA DE GOIANIA	200081676	INDEPENDENCIA S1	09/12/2020 07:13	09/12/2020 08:45	09/12/2020 07:13	09/12/2020 08:45	1,53	1	1,53	CHI
20201246047	CATURAI	CK21108276	INHUMAS S1	09/12/2020 07:13	09/12/2020 10:17	09/12/2020 07:13	09/12/2020 10:17	3,06	1	3,06	CHI
20201246950	PIRENOPOLIS	PV12334635	CORUMBA	09/12/2020 07:13	09/12/2020 13:31	09/12/2020 07:13	09/12/2020 13:31	6,30	8	50,40	CHI
20201246054	PADRE BERNARDO	PB12376755	PADRE BERNARDO	09/12/2020 07:14	09/12/2020 12:30	09/12/2020 07:14	09/12/2020 12:30	5,26	2	10,52	CHI
20201246088	ABADIA DE GOIAS	TR32053718	GUAPO S1	09/12/2020 07:14	09/12/2020 08:22	09/12/2020 07:14	09/12/2020 08:22	1,12	12	13,46	CHI
20201246088	TRINDADE	TR32053718	GUAPO S1	09/12/2020 07:14	09/12/2020 08:22	09/12/2020 07:14	09/12/2020 08:22	1,12	1	1,12	CHI
20201246062	MARA ROSA	MQ21182372	MARA ROSA	09/12/2020 07:15	09/12/2020 10:48	09/12/2020 07:15	09/12/2020 10:48	3,54	1	3,54	CHI
20201246065	NOVO BRASIL	1460010386	JUSSARA	09/12/2020 07:15	09/12/2020 11:05	09/12/2020 07:15	09/12/2020 11:05	3,82	1	3,82	CHI
20201248530	PEROLANDIA	DP12260360	JATAÍ S1	09/12/2020 07:15	09/12/2020 12:39	09/12/2020 07:15	09/12/2020 12:39	5,39	3	16,16	CHI
20201248939	LEOPOLDO DE BULHOES	LB12011166	DAIA S2	09/12/2020 07:15	09/12/2020 23:55	09/12/2020 07:15	09/12/2020 23:55	16,65	1	16,65	CHI
20201248939	SILVANIA	LB12011166	DAIA S2	09/12/2020 07:15	09/12/2020 23:55	09/12/2020 07:15	09/12/2020 23:55	16,65	2	33,31	CHI
20201246071	RIO VERDE	RV12260251	RIO VERDE S1	09/12/2020 07:16	11/12/2020 15:13	09/12/2020 07:16	09/12/2020 22:51	15,58	6	93,49	CHI
20201246071	RIO VERDE	RV12260251	RIO VERDE S1	09/12/2020 07:16	11/12/2020 15:13	09/12/2020 10:03	09/12/2020 22:51	12,79	2	25,59	CHI
20201246071	RIO VERDE	RV12260251	RIO VERDE S1	09/12/2020 07:16	11/12/2020 15:13	09/12/2020 22:57	10/12/2020 11:54	12,95	5	64,75	CHI
20201246071	RIO VERDE	RV12260162	RIO VERDE S1	09/12/2020 07:16	11/12/2020 15:13	09/12/2020 22:57	10/12/2020 12:42	13,74	1	13,74	CHI
20201246071	RIO VERDE	RV12260251	RIO VERDE S1	09/12/2020 07:16	11/12/2020 15:13	09/12/2020 07:16	10/12/2020 13:27	30,19	6	181,16	CHI
20201246071	RIO VERDE	RV12260251	RIO VERDE S1	09/12/2020 07:16	11/12/2020 15:13	09/12/2020 07:16	10/12/2020 14:48	31,53	3	94,59	CHI
20201246071	RIO VERDE	RV21246426	RIO VERDE S1	09/12/2020 07:16	11/12/2020 15:13	09/12/2020 10:03	10/12/2020 15:04	29,02	1	29,02	CHI
20201246071	RIO VERDE	RV21260066	RIO VERDE S1	09/12/2020 07:16	11/12/2020 15:13	09/12/2020 22:57	11/12/2020 15:13	40,27	1	40,27	CHI
20201247535	AMARALINA	LC12182475	SAO MIGUEL DO ARAGUAIA	09/12/2020 07:16	09/12/2020 12:20	09/12/2020 07:16	09/12/2020 12:20	5,06	74	374,13	CHI
20201247960	BRITANIA	BT12060643	BRITANIA	09/12/2020 07:16	09/12/2020 12:03	09/12/2020 07:16	09/12/2020 12:03	4,79	13	62,23	CHI
20201246080	POSSE	PS12235292	IACIARA S2	09/12/2020 07:17	09/12/2020 14:21	09/12/2020 07:17	09/12/2020 14:21	7,06	16	113,00	CHI
20201246093	PARAUNA	PU12391520	FIRMINOPOLIS S2	09/12/2020 07:17	09/12/2020 18:00	09/12/2020 07:17	09/12/2020 18:00	10,71	2	21,42	CHI
20201246530	BARRO ALTO	BA12156230	BARRO ALTO	09/12/2020 07:17	09/12/2020 14:10	09/12/2020 07:17	09/12/2020 14:10	6,88	40	275,23	CHI
20201246530	SANTA RITA DO NOVO DESTINO	BA12156230	BARRO ALTO	09/12/2020 07:17	09/12/2020 14:10	09/12/2020 07:17	09/12/2020 14:10	6,88	18	123,86	CHI
20201246094	NOVA VENEZA	NV12270571	NEROPOLIS S1	09/12/2020 07:18	09/12/2020 15:30	09/12/2020 07:18	09/12/2020 15:30	8,20	1	8,20	CHI
20201246095	SAO MIGUEL DO ARAGUAIA	SM12143671	SAO MIGUEL DO ARAGUAIA	09/12/2020 07:18	09/12/2020 08:08	09/12/2020 07:18	09/12/2020 08:08	0,83	276	229,69	CHI
20201246096	GUARANI DE GOIAS	GY12393812	IACIARA S1	09/12/2020 07:18	09/12/2020 09:29	09/12/2020 07:18	09/12/2020 09:29	2,18	21	45,82	CHI
20201246103	ARUANA	AK11253725	ARUANA	09/12/2020 07:18	09/12/2020 11:19	09/12/2020 07:18	09/12/2020 11:19	4,00	43	172,11	CHI
20201246195	CAIAPONIA	CP12190363	CAIAPONIA	09/12/2020 07:19	09/12/2020 10:27	09/12/2020 07:19	09/12/2020 10:27	3,13	4	12,50	CHI
20201246195	DOVERLANDIA	CP12190363	CAIAPONIA	09/12/2020 07:19	09/12/2020 10:27	09/12/2020 07:19	09/12/2020 10:27	3,13	6	18,75	CHI
20201246114	TRINDADE	10022399940	GOYA S1	09/12/2020 07:20	09/12/2020 09:14	09/12/2020 07:20	09/12/2020 09:14	1,90	1	1,90	CHI
20201246117	HEITORAI	10030648970	ITAPURANGA	09/12/2020 07:20	10/12/2020 02:11	09/12/2020 07:20	10/12/2020 02:11	18,83	1	18,83	CHI
20201246892	EDEIA	EA12044006	EDEIA	09/12/2020 07:20	09/12/2020 12:48	09/12/2020 07:20	09/12/2020 12:48	5,47	12	65,58	CHI
20201246125	AMARALINA	LC12170975	MARA ROSA	09/12/2020 07:21	09/12/2020 10:45	09/12/2020 07:21	09/12/2020 10:45	3,38	11	37,22	CHI
20201246690	SANCLERLANDIA	SC12376362	FIRMINOPOLIS S2	09/12/2020 07:21	09/12/2020 15:58	09/12/2020 07:21	09/12/2020 15:58	8,61	10	86,08	CHI
20201246130	ALTO PARAISO DE GOIAS	BF21131837	FLORES DE GOIAS	09/12/2020 07:22	09/12/2020 16:50	09/12/2020 07:22	09/12/2020 16:50	9,46	1	9,46	CHI
20201246134	FORMOSA	FA12302750	ITIQUEIRA	09/12/2020 07:22	09/12/2020 11:22	09/12/2020 07:22	09/12/2020 11:22	3,98	4	15,94	CHI
20201246138	PORANGATU	PO21276642	PORANGATU	09/12/2020 07:23	09/12/2020 08:40	09/12/2020 07:23	09/12/2020 08:40	1,28	1	1,28	CHI
20201246148	ESTRELA DO NORTE	MQ12208361	MARA ROSA	09/12/2020 07:23	09/12/2020 14:59	09/12/2020 07:23	09/12/2020 14:59	7,58	4	30,34	CHI
20201247526	PIRENOPOLIS	PV12285272	CORUMBA	09/12/2020 07:23	09/12/2020 12:04	09/12/2020 07:23	09/12/2020 12:04	4,67	10	46,71	CHI
20201248698	PIRACANJUBA	PJ12257906	PIRACANJUBA	09/12/2020 07:23	10/12/2020 10:31	09/12/2020 07:23	10/12/2020 10:31	27,13	4	108,52	CHI
20201246156	CACHOEIRA DOURADA	CD12222463	CACHOEIRA DOURADA	09/12/2020 07:24	09/12/2020 11:48	09/12/2020 07:24	09/12/2020 11:48	4,38	30	131,52	CHI
20201246156	DISTRITO FEDERAL	CD12222463	CACHOEIRA DOURADA	09/12/2020 07:24	09/12/2020 11:48	09/12/2020 07:24	09/12/2020 11:48	4,38	1	4,38	CHI

20201249041	SANTA RITA DO NOVO DESTINO	DF12382135	BARRO ALTO	09/12/2020 07:25	09/12/2020 14:52	09/12/2020 07:25	09/12/2020 14:52	7,44	2	14,87	CHI
20201249041	BARRO ALTO	DF12382135	BARRO ALTO	09/12/2020 07:25	09/12/2020 14:52	09/12/2020 07:25	09/12/2020 14:52	7,44	34	252,86	CHI
20201246164	ITABERAI	IB21014770	ITABERAI S2	09/12/2020 07:26	09/12/2020 17:00	09/12/2020 07:26	09/12/2020 17:00	9,56	1	9,56	CHI
20201246167	ITAPURANGA	IK21299990	ITAPURANGA	09/12/2020 07:26	09/12/2020 10:41	09/12/2020 07:26	09/12/2020 10:41	3,24	4	12,97	CHI
20201246168	SERRANOPOLIS	SX12260287	JATAI S1	09/12/2020 07:26	10/12/2020 02:32	09/12/2020 07:26	09/12/2020 12:00	4,56	2	9,12	CHI
20201246168	SERRANOPOLIS	SX12260287	JATAI S1	09/12/2020 07:26	10/12/2020 02:32	09/12/2020 07:26	10/12/2020 02:32	19,09	1	19,09	CHI
20201246168	SERRANOPOLIS	SX12260287	JATAI S1	09/12/2020 07:26	10/12/2020 02:32	09/12/2020 19:36	10/12/2020 02:32	6,93	3	20,80	CHI
20201247806	FIRMINOPOLIS	FR11024058	FIRMINOPOLIS S1	09/12/2020 07:26	09/12/2020 15:20	09/12/2020 07:26	09/12/2020 15:20	7,90	79	624,19	CHI
20201246173	CACHOEIRA DE GOIAS	CG21158955	FIRMINOPOLIS S2	09/12/2020 07:27	10/12/2020 03:44	09/12/2020 07:27	10/12/2020 03:44	20,28	1	20,28	CHI
20201246177	APARECIDA DE GOIANIA	AP11166678	INDEPENDENCIA S2	09/12/2020 07:27	09/12/2020 11:03	09/12/2020 07:27	09/12/2020 11:03	3,59	177	635,38	CHI
20201246193	LUZIANIA	LZ12349077	PAMPLONA	09/12/2020 07:27	09/12/2020 17:41	09/12/2020 07:27	09/12/2020 17:41	10,22	11	112,44	CHI
20201246188	CACHOEIRA DOURADA	CD21000001	CACHOEIRA DOURADA	09/12/2020 07:28	09/12/2020 12:30	09/12/2020 07:28	09/12/2020 12:30	5,02	2	10,05	CHI
20201246191	ARAGOIANIA	680008226	GUAPO S2	09/12/2020 07:28	09/12/2020 09:42	09/12/2020 07:28	09/12/2020 09:42	2,22	1	2,22	CHI
20201247243	LUZIANIA	LZ11370842	RIO VERMELHO	09/12/2020 07:30	09/12/2020 13:28	09/12/2020 07:30	09/12/2020 13:28	5,96	7	41,74	CHI
20201246214	GOIANIA	GN11060086	AEROPORTO S3	09/12/2020 07:31	09/12/2020 12:14	09/12/2020 08:43	09/12/2020 12:14	3,52	26	91,50	CHI
20201246220	APARECIDA DO RIO DOCE	AW12341137	CACHOEIRA ALTA	09/12/2020 07:32	09/12/2020 14:10	09/12/2020 07:32	09/12/2020 14:10	6,63	1	6,63	CHI
20201246222	ARUANA	AK12341206	BRITANIA	09/12/2020 07:32	09/12/2020 09:40	09/12/2020 07:32	09/12/2020 09:40	2,13	5	10,64	CHI
20201246225	INACIOLANDIA	CD12000137	CACHOEIRA DOURADA	09/12/2020 07:32	09/12/2020 16:20	09/12/2020 07:32	09/12/2020 16:20	8,79	18	158,24	CHI
20201246275	CABECEIRAS	CW12052029	ITIQUIRA	09/12/2020 07:32	10/12/2020 12:03	09/12/2020 07:32	10/12/2020 12:03	28,52	11	313,74	CHI
20201246717	SAO MIGUEL DO ARAGUAIA	SM12013036	SAO MIGUEL DO ARAGUAIA	09/12/2020 07:32	09/12/2020 11:07	09/12/2020 07:32	09/12/2020 11:07	3,58	22	78,70	CHI
20201246235	CUMARI	CT21152871	CATALAO S2	09/12/2020 07:33	09/12/2020 11:03	09/12/2020 07:33	09/12/2020 11:03	3,48	1	3,48	CHI
20201247214	HIDROLANDIA	HD32000197	CEPAIGO S1	09/12/2020 07:33	09/12/2020 13:56	09/12/2020 07:33	09/12/2020 13:56	6,38	18	114,81	CHI
20201247719	SENADOR CANEDO	SW11054745	SENADOR CANEDO	09/12/2020 07:33	09/12/2020 21:59	09/12/2020 07:33	09/12/2020 21:59	14,43	134	1933,96	CHI
20201246238	IPORA	730081618	IPORA	09/12/2020 07:34	09/12/2020 10:34	09/12/2020 07:34	09/12/2020 10:34	3,00	1	3,00	CHI
20201246241	CATALAO	CT12165268	CATALAO S1	09/12/2020 07:34	09/12/2020 18:31	09/12/2020 07:34	09/12/2020 18:31	10,94	2	21,89	CHI
20201246511	ITAPIRAPUA	NB12396088	JUSSARA	09/12/2020 07:34	09/12/2020 17:29	09/12/2020 07:34	09/12/2020 17:29	9,92	4	39,66	CHI
20201246511	NOVO BRASIL	NB12396088	JUSSARA	09/12/2020 07:34	09/12/2020 17:29	09/12/2020 07:34	09/12/2020 17:29	9,92	5	49,58	CHI
20201246609	NOVA CRIXAS	NA12391973	NOVA CRIXAS	09/12/2020 07:34	09/12/2020 19:27	09/12/2020 07:34	09/12/2020 19:27	11,87	15	178,07	CHI
20201246251	APARECIDA DE GOIANIA	16912834	ATLANTICO S3	09/12/2020 07:35	09/12/2020 09:52	09/12/2020 07:35	09/12/2020 09:52	2,28	1	2,28	CHI
20201246253	BARRO ALTO	BA21357144	BARRO ALTO	09/12/2020 07:35	09/12/2020 19:16	09/12/2020 07:35	09/12/2020 19:16	11,68	1	11,68	CHI
20201246255	MONTES CLAROS DE GOIAS	ME12088935	IPORA	09/12/2020 07:35	09/12/2020 11:50	09/12/2020 07:35	09/12/2020 11:50	4,24	1	4,24	CHI
20201246257	QUIRINOPOLIS	80071843	QUIRINOPOLIS	09/12/2020 07:35	09/12/2020 10:42	09/12/2020 07:35	09/12/2020 10:42	3,11	1	3,11	CHI
20201246258	ALTO PARAISO DE GOIAS	10001506704	FLORES DE GOIAS	09/12/2020 07:35	09/12/2020 17:47	09/12/2020 07:35	09/12/2020 17:47	10,19	1	10,19	CHI
20201252249	JATAI	JT21219567	JATAI S1	09/12/2020 07:35	10/12/2020 01:09	09/12/2020 07:35	10/12/2020 01:09	17,55	1	17,55	CHI
20201246263	ALEXANIA	AX11393202	ALEXANIA	09/12/2020 07:36	09/12/2020 11:57	09/12/2020 07:36	09/12/2020 11:57	4,35	8	34,79	CHI
20201246265	CRISTALINA	KR12351414	PAMPLONA	09/12/2020 07:36	10/12/2020 10:03	09/12/2020 07:36	09/12/2020 17:50	10,24	2	20,48	CHI
20201246265	CRISTALINA	KR12351414	PAMPLONA	09/12/2020 07:36	10/12/2020 10:03	09/12/2020 07:36	10/12/2020 10:03	26,46	4	105,84	CHI
20201246274	BALIZA	BH21238892	BOM JARDIM	09/12/2020 07:36	09/12/2020 11:33	09/12/2020 07:36	09/12/2020 11:33	3,94	1	3,94	CHI
20201246278	JANDAIA	JD12096921	PALMEIRAS	09/12/2020 07:36	09/12/2020 13:48	09/12/2020 07:36	09/12/2020 13:48	6,19	4	24,74	CHI
20201246280	APARECIDA DE GOIANIA	AP11168685	ANHANGUERA	09/12/2020 07:36	09/12/2020 12:38	09/12/2020 07:36	09/12/2020 12:38	5,02	225	1128,94	CHI
20201246281	RIO VERDE	630018364	RIO VERDE S1	09/12/2020 07:37	09/12/2020 11:57	09/12/2020 07:37	09/12/2020 11:57	4,33	1	4,33	CHI
20201246289	RIO VERDE	RV21213468	RIO VERDE S1	09/12/2020 07:38	09/12/2020 12:25	09/12/2020 07:38	09/12/2020 12:25	4,78	1	4,78	CHI
20201246297	URUACU	UR21347316	URUACU	09/12/2020 07:38	09/12/2020 09:32	09/12/2020 07:38	09/12/2020 09:32	1,89	5	9,44	CHI
20201247289	SANTA RITA DO NOVO DESTINO	BA21263300	BARRO ALTO	09/12/2020 07:38	09/12/2020 13:34	09/12/2020 07:38	09/12/2020 13:34	5,93	20	118,56	CHI
20201246300	CRISTALINA	KR12244611	CRISTALINA S2	09/12/2020 07:39	09/12/2020 11:55	09/12/2020 07:39	09/12/2020 11:55	4,26	2	8,51	CHI
20201247278	IVOLANDIA	IV12334659	IPORA	09/12/2020 07:39	09/12/2020 16:59	09/12/2020 07:39	09/12/2020 16:59	9,32	2	18,65	CHI
20201246313	SANTA TEREZINHA DE GOIAS	SG12237497	SANTA TEREZINHA	09/12/2020 07:41	09/12/2020 14:52	09/12/2020 07:41	09/12/2020 14:52	7,17	4	28,70	CHI
20201246315	MINACU	IH21244543	MINACU	09/12/2020 07:41	10/12/2020 13:50	09/12/2020 07:41	10/12/2020 13:50	30,14	1	30,14	CHI
20201247140	CORREGO DO OURO	CO12028902	SAO LUIZ DOS MONTES BELOS	09/12/2020 07:41	09/12/2020 16:15	09/12/2020 07:41	09/12/2020 16:15	8,55	53	453,39	CHI
20201246328	BURITINOPOLIS	BQ11208227	IACIARA S2	09/12/2020 07:42	09/12/2020 11:16	09/12/2020 07:42	09/12/2020 11:16	3,56	28	99,70	CHI
20201246341	GOIATUBA	BJ12309032	BOM JESUS DE GOIAS	09/12/2020 07:43	09/12/2020 14:21	09/12/2020 07:43	09/12/2020 14:21	6,63	2	13,25	CHI

20201246343	PETROLINA DE GOIAS	320001313	PETROLINA	09/12/2020 07:43	09/12/2020 11:40	09/12/2020 07:43	09/12/2020 11:40	3,94	1	3,94	CHI
20201246347	PIRACANJUBA	PJ11064631	PIRACANJUBA	09/12/2020 07:43	09/12/2020 17:04	09/12/2020 07:43	09/12/2020 17:04	9,34	52	485,43	CHI
20201246642	PALESTINA DE GOIAS	PY12396118	PALESTINA	09/12/2020 07:43	09/12/2020 09:38	09/12/2020 07:43	09/12/2020 09:38	1,91	5	9,57	CHI
20201246354	CALDAS NOVAS	760024157	SERRA DE CALDAS	09/12/2020 07:44	09/12/2020 19:25	09/12/2020 07:44	09/12/2020 19:25	11,67	1	11,67	CHI
20201246360	GOIANIA	11224058	FERROVIARIO S2	09/12/2020 07:45	09/12/2020 10:31	09/12/2020 07:45	09/12/2020 10:31	2,76	1	2,76	CHI
20201246361	MINEIROS	10012830001	PARQUE DAS EMAS	09/12/2020 07:45	09/12/2020 19:28	09/12/2020 07:45	09/12/2020 19:28	11,71	1	11,71	CHI
20201246367	NIQUELANDIA	NQ21213125	NIQUELANDIA SUBTRANSMISSAO	09/12/2020 07:46	09/12/2020 12:16	09/12/2020 07:46	09/12/2020 12:16	4,50	1	4,50	CHI
20201246372	ARUANA	AK21250584	MOZARLANDIA	09/12/2020 07:46	09/12/2020 18:25	09/12/2020 07:46	09/12/2020 18:25	10,64	1	10,64	CHI
20201248105	SANTA TEREZINHA DE GOIAS	SG12181588	SANTA TEREZINHA	09/12/2020 07:46	09/12/2020 18:15	09/12/2020 07:46	09/12/2020 18:15	10,47	6	62,81	CHI
20201248105	CAMPOS VERDES	SG12181588	SANTA TEREZINHA	09/12/2020 07:46	09/12/2020 18:15	09/12/2020 07:46	09/12/2020 18:15	10,47	8	83,74	CHI
20201246379	NOVA VENEZA	NV21009851	INHUMAS S1	09/12/2020 07:47	09/12/2020 13:00	09/12/2020 07:47	09/12/2020 13:00	5,21	2	10,43	CHI
20201246385	ITAGUARI	II2300335	ITABERAI S1	09/12/2020 07:47	10/12/2020 15:50	09/12/2020 07:47	10/12/2020 15:48	32,01	2	64,02	CHI
20201246385	ITABERAI	II12220181	ITABERAI S1	09/12/2020 07:47	10/12/2020 15:50	09/12/2020 07:47	10/12/2020 15:50	32,04	6	192,22	CHI
20201246385	ITABERAI	II12220181	ITABERAI S1	09/12/2020 07:47	10/12/2020 15:50	10/12/2020 14:24	10/12/2020 15:50	1,42	13	18,48	CHI
20201246385	ITAGUARI	II12220181	ITABERAI S1	09/12/2020 07:47	10/12/2020 15:50	10/12/2020 14:24	10/12/2020 15:50	1,42	2	2,84	CHI
20201247302	NOVA AURORA	NE12149259	CATALAO S1	09/12/2020 07:47	09/12/2020 10:36	09/12/2020 07:47	09/12/2020 10:36	2,81	6	16,86	CHI
20201247568	ALTO PARAISO DE GOIAS	BF12245429	FLORES DE GOIAS	09/12/2020 07:47	09/12/2020 21:22	09/12/2020 07:47	09/12/2020 21:22	13,58	8	108,65	CHI
20201247568	SAO JOAO D ALIANCA	BF12245429	FLORES DE GOIAS	09/12/2020 07:47	09/12/2020 21:22	09/12/2020 07:47	09/12/2020 21:22	13,58	1	13,58	CHI
20201247808	CAMPOS VERDES	VD12264097	SANTA TEREZINHA	09/12/2020 07:48	10/12/2020 09:38	09/12/2020 07:48	10/12/2020 09:38	25,82	6	154,94	CHI
20201246404	EDEIA	EA12160401	EDEIA	09/12/2020 07:49	09/12/2020 22:16	09/12/2020 07:49	09/12/2020 22:16	14,44	38	548,61	CHI
20201246517	FAINA	FC12336280	GOIAS	09/12/2020 07:49	10/12/2020 10:31	09/12/2020 07:49	10/12/2020 10:31	26,69	3	80,06	CHI
20201246647	SANTO ANTONIO DO DESCOBERTO	SN12382244	AGUAS LINDAS DE GOIAS S2	09/12/2020 07:49	09/12/2020 09:18	09/12/2020 07:49	09/12/2020 09:18	1,48	14	20,70	CHI
20201247724	FAINA	FC12084191	GOIAS	09/12/2020 07:49	09/12/2020 18:40	09/12/2020 07:49	09/12/2020 18:40	10,84	3	32,51	CHI
20201246413	BALIZA	BM12208954	BOM JARDIM	09/12/2020 07:50	09/12/2020 10:05	09/12/2020 07:50	09/12/2020 10:05	2,23	5	11,17	CHI
20201246425	SENADOR CANEDO	SW11169127	CEPAIGO S1	09/12/2020 07:51	09/12/2020 10:04	09/12/2020 07:51	09/12/2020 10:04	2,20	6	13,21	CHI
20201246427	JATAI	RV12104996	JATAI S2	09/12/2020 07:51	09/12/2020 09:36	09/12/2020 07:51	09/12/2020 09:36	1,73	12	20,81	CHI
20201246427	RIO VERDE	RV12104996	JATAI S2	09/12/2020 07:51	09/12/2020 09:36	09/12/2020 07:51	09/12/2020 09:36	1,73	7	12,14	CHI
20201246454	FORMOSO	ET12143681	MARA ROSA	09/12/2020 07:51	09/12/2020 10:56	09/12/2020 07:51	09/12/2020 10:56	3,07	13	39,94	CHI
20201247104	LUZIANIA	LZ12370631	MARAJOARA	09/12/2020 07:51	09/12/2020 10:52	09/12/2020 07:51	09/12/2020 10:52	3,01	12	36,07	CHI
20201247153	MONTIVIDIU	MV12303520	MONTIVIDIU T	09/12/2020 07:51	09/12/2020 14:24	09/12/2020 07:51	09/12/2020 14:24	6,55	3	19,64	CHI
20201247153	RIO VERDE	MV12303520	MONTIVIDIU T	09/12/2020 07:51	09/12/2020 14:24	09/12/2020 07:51	09/12/2020 14:24	6,55	1	6,55	CHI
20201246431	SAO LUIS DE MONTES BELOS	SL21308398	FIRMINOPOLIS S2	09/12/2020 07:52	09/12/2020 10:11	09/12/2020 07:52	09/12/2020 10:11	2,31	1	2,31	CHI
20201246831	ALEXANIA	AX12351026	ALEXANIA	09/12/2020 07:52	09/12/2020 11:18	09/12/2020 07:52	09/12/2020 11:18	3,43	78	267,32	CHI
20201249099	NOVA CRIXAS	NA12049348	NOVA CRIXAS	09/12/2020 07:52	09/12/2020 14:30	09/12/2020 07:52	09/12/2020 14:30	6,62	7	46,36	CHI
20201246989	CALDAS NOVAS	CN11000033	CALDAS NOVAS S2	09/12/2020 07:53	09/12/2020 10:14	09/12/2020 07:53	09/12/2020 10:14	2,34	123	287,44	CHI
20201246451	MOZARLANDIA	MZ12300442	MOZARLANDIA	09/12/2020 07:54	10/12/2020 16:16	09/12/2020 07:54	10/12/2020 16:16	32,37	1	32,37	CHI
20201246451	MOZARLANDIA	MZ12300442	MOZARLANDIA	09/12/2020 07:54	10/12/2020 16:16	09/12/2020 16:00	10/12/2020 16:16	24,27	2	48,54	CHI
20201246453	SAO MIGUEL DO ARAGUAIA	SM21013013	SAO MIGUEL DO ARAGUAIA	09/12/2020 07:54	09/12/2020 15:48	09/12/2020 07:54	09/12/2020 15:48	7,89	1	7,89	CHI
20201246456	CAMPO LIMPO	AN12261235	NEROPOLIS S1	09/12/2020 07:54	09/12/2020 10:44	09/12/2020 07:54	09/12/2020 10:44	2,82	14	39,48	CHI
20201246461	OUVIDOR	CT21266219	CATALAO S1	09/12/2020 07:55	09/12/2020 10:01	09/12/2020 07:55	09/12/2020 10:01	2,10	1	2,10	CHI
20201246462	PORTEIROAO	CL21306018	RIO DOS BOIS	09/12/2020 07:55	09/12/2020 15:11	09/12/2020 07:55	09/12/2020 15:11	7,26	1	7,26	CHI
20201246463	MOSSAMEDES	MD21318827	FIRMINOPOLIS S2	09/12/2020 07:55	09/12/2020 16:40	09/12/2020 07:55	09/12/2020 16:40	8,74	1	8,74	CHI
20201246472	SANTA ROSA DE GOIAS	540002239	INHUMAS S1	09/12/2020 07:56	09/12/2020 15:00	09/12/2020 07:56	09/12/2020 15:00	7,06	1	7,06	CHI
20201246475	COCALZINHO DE GOIAS	ZN12104981	AGUAS LINDAS DE GOIAS S2	09/12/2020 07:56	09/12/2020 15:42	09/12/2020 07:56	09/12/2020 15:42	7,75	3	23,26	CHI
20201247400	ITAGUARI	IC12065273	ITABERAI S1	09/12/2020 07:56	10/12/2020 13:02	09/12/2020 07:56	10/12/2020 13:02	29,10	11	320,14	CHI
20201246489	TRINDADE	TR21381814	TRINDADE	09/12/2020 07:58	09/12/2020 14:45	09/12/2020 07:58	09/12/2020 14:45	6,77	1	6,77	CHI
20201248691	HIDROLANDIA	HD12389462	CEPAIGO S2	09/12/2020 07:58	09/12/2020 20:13	09/12/2020 07:58	09/12/2020 20:13	12,25	7	85,74	CHI
20201246503	JATAI	290198033	JATAI S2	09/12/2020 07:59	09/12/2020 09:31	09/12/2020 07:59	09/12/2020 09:31	1,52	1	1,52	CHI
20201248122	ALEXANIA	AX12000108	CORUMBA	09/12/2020 07:59	09/12/2020 12:34	09/12/2020 07:59	09/12/2020 12:34	4,58	11	50,42	CHI
20201248122	CORUMBA DE GOIAS	AX12000108	CORUMBA	09/12/2020 07:59	09/12/2020 12:34	09/12/2020 07:59	09/12/2020 12:34	4,58	4	18,33	CHI
20201248997	DOVERLANDIA	DV11393514	CAIAPONIA	09/12/2020 07:59	09/12/2020 15:02	09/12/2020 07:59	09/12/2020 15:02	7,04	17	119,73	CHI

20201249127	ORIZONA	OZ12300550	PIRES DO RIO S2	09/12/2020 07:59	09/12/2020 20:34	09/12/2020 07:59	09/12/2020 20:34	12,58	53	666,86	CHI
20201246504	FLORES DE GOIAS	FB21044975	IACIARA S2	09/12/2020 08:00	09/12/2020 18:25	09/12/2020 08:00	09/12/2020 18:25	10,41	1	10,41	CHI
20201246505	GOIANIA	10004740520	CARAIAS S2	09/12/2020 08:00	09/12/2020 13:18	09/12/2020 08:00	09/12/2020 13:18	5,29	1	5,29	CHI
20201246507	GOIANIA	GN11216529	FERROVIARIO S1	09/12/2020 08:00	09/12/2020 10:09	09/12/2020 09:08	09/12/2020 10:09	1,02	16	16,27	CHI
20201246509	GOIATUBA	JV21263810	GOIATUBA S1	09/12/2020 08:00	09/12/2020 19:06	09/12/2020 08:00	09/12/2020 19:06	11,08	1	11,08	CHI
20201246516	MINACU	IH12230302	MINACU	09/12/2020 08:01	09/12/2020 09:59	09/12/2020 08:01	09/12/2020 09:59	1,96	3	5,88	CHI
20201246518	CATALAO	CT21192590	CATALAO S1	09/12/2020 08:01	09/12/2020 13:46	09/12/2020 08:01	09/12/2020 13:46	5,74	1	5,74	CHI
20201246521	ITABERAI	IB21047740	ITABERAI S2	09/12/2020 08:01	09/12/2020 09:23	09/12/2020 08:01	09/12/2020 09:23	1,35	1	1,35	CHI
20201246523	GOIANIA	16113901	CAMPINAS S2	09/12/2020 08:01	09/12/2020 14:40	09/12/2020 08:01	09/12/2020 14:40	6,65	1	6,65	CHI
20201246524	CABECEIRAS	CW21154476	ITUIQUIRA	09/12/2020 08:01	09/12/2020 16:23	09/12/2020 08:01	09/12/2020 16:23	8,35	1	8,35	CHI
20201246531	MINACU	IH21255548	MINACU	09/12/2020 08:02	11/12/2020 11:18	09/12/2020 08:02	11/12/2020 11:18	51,26	1	51,26	CHI
20201246534	CRISTALINA	KR11256883	CRISTALINA S2	09/12/2020 08:03	09/12/2020 14:28	09/12/2020 08:03	09/12/2020 14:28	6,41	1	6,41	CHI
20201246542	GOIAS	GS21286904	MATRINCHA	09/12/2020 08:03	09/12/2020 18:20	09/12/2020 08:03	09/12/2020 18:20	10,27	1	10,27	CHI
20201245262	CORUMBA DE GOIAS	CB12114199	CORUMBA	09/12/2020 08:04	09/12/2020 12:23	09/12/2020 08:04	09/12/2020 12:23	4,32	14	60,43	CHI
20201246546	ORIZONA	OZ12026601	PIRES DO RIO S2	09/12/2020 08:04	09/12/2020 21:08	09/12/2020 08:04	09/12/2020 21:08	13,08	13	170,00	CHI
20201246557	GOIATUBA	BJ21271232	RIO DOS BOIS	09/12/2020 08:05	10/12/2020 14:52	09/12/2020 08:05	10/12/2020 14:52	30,78	1	30,78	CHI
20201246559	APARECIDA DE GOIANIA	16827510	REAL S2	09/12/2020 08:05	09/12/2020 10:16	09/12/2020 08:05	09/12/2020 10:16	2,18	1	2,18	CHI
20201246565	COCALZINHO DE GOIAS	ZN21194703	COCALZINHO	09/12/2020 08:06	09/12/2020 21:09	09/12/2020 08:06	09/12/2020 21:09	13,05	1	13,05	CHI
20201246566	MONTE ALEGRE DE GOIAS	MA12238057	SAO DOMINGOS	09/12/2020 08:06	09/12/2020 12:01	09/12/2020 08:06	09/12/2020 12:01	3,91	31	121,36	CHI
20201246570	GOIANESIA	GE12353207	GOIANESIA S1	09/12/2020 08:06	09/12/2020 16:30	09/12/2020 08:06	09/12/2020 16:30	8,39	1	8,39	CHI
20201246572	ITABERAI	GS12206906	ITABERAI S1	09/12/2020 08:06	09/12/2020 10:51	09/12/2020 08:06	09/12/2020 10:51	2,73	15	41,01	CHI
20201246572	GOIAS	GS12206906	ITABERAI S1	09/12/2020 08:06	09/12/2020 10:51	09/12/2020 08:06	09/12/2020 10:51	2,73	2	5,47	CHI
20201246592	HIDROLANDIA	HD21388751	CEPAIGO S2	09/12/2020 08:08	09/12/2020 10:05	09/12/2020 08:08	09/12/2020 10:05	1,94	1	1,94	CHI
20201246593	CAMPO ALEGRE DE GOIAS	CM21155525	CAMPO ALEGRE DE GOIAS	09/12/2020 08:08	09/12/2020 18:45	09/12/2020 08:08	09/12/2020 18:45	10,61	1	10,61	CHI
20201246596	CALDAS NOVAS	760407861	SERRA DE CALDAS	09/12/2020 08:08	09/12/2020 20:53	09/12/2020 08:08	09/12/2020 20:53	12,76	1	12,76	CHI
20201246597	PORANGATU	PO12102901	PORANGATU	09/12/2020 08:08	09/12/2020 09:29	09/12/2020 08:08	09/12/2020 09:29	1,34	4	5,37	CHI
20201246600	SAO MIGUEL DO ARAGUAIA	SM12114598	SAO MIGUEL DO ARAGUAIA	09/12/2020 08:08	09/12/2020 12:41	09/12/2020 08:08	09/12/2020 12:41	4,54	9	40,85	CHI
20201246605	GOIANIA	11512799	GOIANIA LESTE S2	09/12/2020 08:09	09/12/2020 10:28	09/12/2020 08:09	09/12/2020 10:28	2,31	1	2,31	CHI
20201246606	MONTIVIDIU	2840039637	MONTIVIDIU T	09/12/2020 08:09	09/12/2020 22:46	09/12/2020 08:09	09/12/2020 22:46	14,61	1	14,61	CHI
20201246612	ITABERAI	IB12238849	ITABERAI S2	09/12/2020 08:09	09/12/2020 10:04	09/12/2020 08:09	09/12/2020 10:04	1,90	2	3,80	CHI
20201246618	COLINAS DO SUL	TI12155523RE	MINACU	09/12/2020 08:10	11/12/2020 10:23	09/12/2020 08:10	09/12/2020 15:17	7,12	14	99,65	CHI
20201246618	COLINAS DO SUL	TI12155523RE	MINACU	09/12/2020 08:10	11/12/2020 10:23	10/12/2020 13:10	11/12/2020 02:52	13,68	11	150,53	CHI
20201246618	COLINAS DO SUL	TI12155523RE	MINACU	09/12/2020 08:10	11/12/2020 10:23	09/12/2020 08:10	11/12/2020 03:29	43,31	3	129,94	CHI
20201246618	COLINAS DO SUL	TI12155523RE	MINACU	09/12/2020 08:10	11/12/2020 10:23	09/12/2020 08:10	11/12/2020 04:32	44,37	1	44,37	CHI
20201246618	COLINAS DO SUL	TI12155523RE	MINACU	09/12/2020 08:10	11/12/2020 10:23	11/12/2020 09:12	11/12/2020 09:41	0,47	15	7,08	CHI
20201246618	COLINAS DO SUL	TI12362148LD	MINACU	09/12/2020 08:10	11/12/2020 10:23	10/12/2020 13:10	11/12/2020 10:23	21,21	3	63,63	CHI
20201246619	GOIANDIRA	GD12078352	CATALAO S1	09/12/2020 08:10	09/12/2020 17:35	09/12/2020 08:10	09/12/2020 17:35	9,41	18	169,42	CHI
20201246624	GOIATUBA	JV12222502	VICENTINOPOLIS	09/12/2020 08:10	09/12/2020 18:07	09/12/2020 08:10	09/12/2020 18:07	9,95	5	49,73	CHI
20201246624	VICENTINOPOLIS	JV12222502	VICENTINOPOLIS	09/12/2020 08:10	09/12/2020 18:07	09/12/2020 08:10	09/12/2020 18:07	9,95	2	19,89	CHI
20201246624	JOVIANIA	JV12222502	VICENTINOPOLIS	09/12/2020 08:10	09/12/2020 18:07	09/12/2020 08:10	09/12/2020 18:07	9,95	1	9,95	CHI
20201249327	CRISTALINA	KR12324646	CRISTALINA S1	09/12/2020 08:10	09/12/2020 19:34	09/12/2020 08:10	09/12/2020 19:34	11,40	3	34,19	CHI
20201249327	IPAMERI	KR12324646	CRISTALINA S1	09/12/2020 08:10	09/12/2020 19:34	09/12/2020 08:10	09/12/2020 19:34	11,40	2	22,79	CHI
20201249885	PONTALINA	PK12189810	PONTALINA	09/12/2020 08:10	09/12/2020 17:44	09/12/2020 08:10	09/12/2020 17:44	9,56	3	28,68	CHI
20201246626	QUIRINOPOLIS	80014136	QUIRINOPOLIS	09/12/2020 08:11	09/12/2020 11:25	09/12/2020 08:11	09/12/2020 11:25	3,22	1	3,22	CHI
20201246629	EDEALINA	ED11280905	PONTALINA	09/12/2020 08:11	09/12/2020 09:56	09/12/2020 08:11	09/12/2020 09:56	1,74	69	119,75	CHI
20201247640	MOIPORA	MO12165608	IPORA	09/12/2020 08:11	09/12/2020 12:20	09/12/2020 08:11	09/12/2020 12:20	4,15	1	4,15	CHI
20201247640	IVOLANDIA	MO12165608	IPORA	09/12/2020 08:11	09/12/2020 12:20	09/12/2020 08:11	09/12/2020 12:20	4,15	17	70,48	CHI
20201246634	PORANGATU	PO12391670	PORANGATU	09/12/2020 08:12	09/12/2020 11:56	09/12/2020 08:12	09/12/2020 11:56	3,72	6	22,34	CHI
20201246636	QUIRINOPOLIS	80089288	QUIRINOPOLIS	09/12/2020 08:12	09/12/2020 13:29	09/12/2020 08:12	09/12/2020 13:29	5,27	1	5,27	CHI
20201246637	GOIANESIA	10016324810	GOIANESIA S2	09/12/2020 08:12	09/12/2020 11:03	09/12/2020 08:12	09/12/2020 11:03	2,85	1	2,85	CHI
20201244042	ITABERAI	HE12310804	ITABERAI S1	09/12/2020 08:14	09/12/2020 22:21	09/12/2020 08:14	09/12/2020 22:21	14,11	1	14,11	CHI

20201244042	HEITORAI	HE12310804	ITABERAI S1	09/12/2020 08:14	09/12/2020 22:21	09/12/2020 08:14	09/12/2020 22:21	14,11	21	296,39	CHI
20201246648	GOIANIA	16831998	FERROVIARIO S3	09/12/2020 08:14	09/12/2020 09:48	09/12/2020 08:14	09/12/2020 09:48	1,57	1	1,57	CHI
20201246653	TURVANIA	TV12047523	FIRMINOPOLIS S2	09/12/2020 08:14	09/12/2020 17:12	09/12/2020 08:14	09/12/2020 17:12	8,96	2	17,92	CHI
20201247128	ESTRELA DO NORTE	ET12168852	MARA ROSA	09/12/2020 08:14	09/12/2020 14:20	09/12/2020 08:14	09/12/2020 14:20	6,10	3	18,30	CHI
20201247128	FORMOSO	ET12168852	MARA ROSA	09/12/2020 08:14	09/12/2020 14:20	09/12/2020 08:14	09/12/2020 14:20	6,10	2	12,20	CHI
20201247238	PILAR DE GOIAS	GG12293454	URUACU	09/12/2020 08:14	10/12/2020 14:34	09/12/2020 08:14	10/12/2020 14:34	30,33	3	90,99	CHI
20201246661	BALIZA	BH11331094	CAIAPONIA	09/12/2020 08:15	09/12/2020 16:31	09/12/2020 08:15	09/12/2020 16:31	8,26	2	16,52	CHI
20201246663	HIDROLANDIA	10025174337	ANHANGUERA	09/12/2020 08:15	09/12/2020 11:04	09/12/2020 08:15	09/12/2020 11:04	2,82	1	2,82	CHI
20201247225	CALDAS NOVAS	CN11114789	SERRA DE CALDAS	09/12/2020 08:15	09/12/2020 17:08	09/12/2020 08:15	09/12/2020 17:08	8,87	80	709,76	CHI
20201246668	GOIANIA	13346090	XAVANTES	09/12/2020 08:16	09/12/2020 11:23	09/12/2020 08:16	09/12/2020 11:23	3,11	1	3,11	CHI
20201246669	SAO DOMINGOS	SD11389251	SAO DOMINGOS	09/12/2020 08:16	09/12/2020 17:29	09/12/2020 08:16	09/12/2020 17:29	9,22	0	0,00	CHI
20201246674	GOIANIA	10004650547	GOYA S2	09/12/2020 08:16	09/12/2020 14:07	09/12/2020 08:16	09/12/2020 14:07	5,84	1	5,84	CHI
20201246676	NOVO BRASIL	NB12246495	JUSSARA	09/12/2020 08:16	09/12/2020 22:16	09/12/2020 08:16	09/12/2020 22:16	13,99	5	69,94	CHI
20201246681	MARA ROSA	MQ12390480	MARA ROSA	09/12/2020 08:16	09/12/2020 16:32	09/12/2020 08:16	09/12/2020 16:32	8,25	4	33,01	CHI
20201246681	CAMPINORTE	MQ12390480	MARA ROSA	09/12/2020 08:16	09/12/2020 16:32	09/12/2020 08:16	09/12/2020 16:32	8,25	1	8,25	CHI
20201247343	ABADIA DE GOIAS	GN31123580	INDEPENDENCIA S2	09/12/2020 08:16	09/12/2020 11:16	09/12/2020 08:16	09/12/2020 11:16	2,99	10	29,87	CHI
20201246696	GOIANIA	11090303	ATLANTICO S3	09/12/2020 08:18	09/12/2020 12:46	09/12/2020 08:18	09/12/2020 12:46	4,45	1	4,45	CHI
20201248911	CAMPOS VERDES	VD12201664	SANTA TEREZINHA	09/12/2020 08:18	09/12/2020 14:54	09/12/2020 08:18	09/12/2020 14:54	6,60	110	725,54	CHI
20201247931	PIRACANJUBA	PJ12000102	CALDAS NOVAS S1	09/12/2020 08:19	09/12/2020 15:54	09/12/2020 08:19	09/12/2020 15:54	7,58	21	159,09	CHI
20201246705	TEREZOPOLIS DE GOIAS	TJ21212672	JUNDIAI S2	09/12/2020 08:20	09/12/2020 21:18	09/12/2020 08:20	09/12/2020 21:18	12,96	1	12,96	CHI
20201246709	SAO MIGUEL DO ARAGUAIA	SM21146492	NOVA CRIXAS	09/12/2020 08:20	09/12/2020 12:09	09/12/2020 08:20	09/12/2020 12:09	3,81	1	3,81	CHI
20201246710	INDIARA	10001523030	EDEIA	09/12/2020 08:20	09/12/2020 23:15	09/12/2020 08:20	09/12/2020 23:15	14,91	1	14,91	CHI
20201249367	URUACU	HL12292170	URUACU	09/12/2020 08:20	09/12/2020 15:23	09/12/2020 08:20	09/12/2020 15:23	7,04	5	35,21	CHI
20201246721	NOVO GAMA	2900025935	MARAJOARA	09/12/2020 08:21	09/12/2020 12:03	09/12/2020 08:21	09/12/2020 12:03	3,69	1	3,69	CHI
20201246729	CACHOEIRA DE GOIAS	CG12233441	FIRMINOPOLIS S2	09/12/2020 08:22	09/12/2020 11:41	09/12/2020 08:22	09/12/2020 11:41	3,31	3	9,92	CHI
20201246732	URUACU	640095665	URUACU	09/12/2020 08:22	09/12/2020 13:11	09/12/2020 08:22	09/12/2020 13:11	4,80	1	4,80	CHI
20201247567	LUZIANIA	LZ12137225	VIANOPOLIS	09/12/2020 08:22	09/12/2020 19:56	09/12/2020 08:22	09/12/2020 19:56	11,56	13	150,28	CHI
20201246734	FORMOSA	610161817	ITIQUEIRA	09/12/2020 08:23	09/12/2020 16:43	09/12/2020 08:23	09/12/2020 16:43	8,34	1	8,34	CHI
20201246739	MARA ROSA	MQ12051834	MARA ROSA	09/12/2020 08:23	09/12/2020 12:17	09/12/2020 08:23	09/12/2020 12:17	3,89	13	50,56	CHI
20201246742	PADRE BERNARDO	PB12382921	PADRE BERNARDO	09/12/2020 08:23	09/12/2020 09:38	09/12/2020 08:23	09/12/2020 09:38	1,24	52	64,35	CHI
20201246744	CRISTALINA	1060018886	CRISTALINA S1	09/12/2020 08:23	09/12/2020 10:05	09/12/2020 08:23	09/12/2020 10:05	1,68	1	1,68	CHI
20201248298	PONTALINA	210062939	PONTALINA	09/12/2020 08:23	09/12/2020 14:36	09/12/2020 08:23	09/12/2020 14:36	6,22	1	6,22	CHI
20201246747	SAO MIGUEL DO ARAGUAIA	SM11216509	SAO MIGUEL DO ARAGUAIA	09/12/2020 08:24	09/12/2020 11:13	09/12/2020 08:24	09/12/2020 11:13	2,81	51	143,15	CHI
20201246762	GOIANESIA	GE12339509	GOIANESIA S2	09/12/2020 08:26	09/12/2020 12:00	09/12/2020 08:26	09/12/2020 12:00	3,56	9	32,06	CHI
20201246763	ALEXANIA	AX12401149	ALEXANIA	09/12/2020 08:26	09/12/2020 23:32	09/12/2020 08:26	09/12/2020 22:55	14,49	1	14,49	CHI
20201246763	ALEXANIA	AX12000154	CORUMBA	09/12/2020 08:26	09/12/2020 23:32	09/12/2020 19:31	09/12/2020 23:32	4,01	22	88,23	CHI
20201246763	CORUMBA DE GOIAS	AX12000154	CORUMBA	09/12/2020 08:26	09/12/2020 23:32	09/12/2020 19:31	09/12/2020 23:32	4,01	4	16,04	CHI
20201246764	LUZIANIA	LZ21084523	MARAJOARA	09/12/2020 08:26	09/12/2020 13:09	09/12/2020 08:26	09/12/2020 13:09	4,71	1	4,71	CHI
20201246773	LUZIANIA	LZ21386183	MARAJOARA	09/12/2020 08:27	09/12/2020 10:51	09/12/2020 08:27	09/12/2020 10:51	2,38	1	2,38	CHI
20201246774	ANAPOLIS	21230067	ANAPOLIS UNIVERSITARIO S2	09/12/2020 08:27	09/12/2020 17:07	09/12/2020 08:27	09/12/2020 17:07	8,66	1	8,66	CHI
20201246778	RIO VERDE	630424548	RIO VERDE S2	09/12/2020 08:28	09/12/2020 12:06	09/12/2020 08:28	09/12/2020 12:06	3,63	1	3,63	CHI
20201246786	APARECIDA DE GOIANIA	10020653164	ANHANGUERA	09/12/2020 08:28	09/12/2020 10:20	09/12/2020 08:28	09/12/2020 10:20	1,86	1	1,86	CHI
20201246792	ITAPURANGA	170024647	ITAPURANGA	09/12/2020 08:29	09/12/2020 17:48	09/12/2020 08:29	09/12/2020 17:48	9,31	1	9,31	CHI
20201246800	MUNDO NOVO DE GOIAS	MH21126633	NOVA CRIXAS	09/12/2020 08:30	09/12/2020 09:42	09/12/2020 08:30	09/12/2020 09:42	1,19	1	1,19	CHI
20201246807	SAO MIGUEL DO ARAGUAIA	SM21300971	SAO MIGUEL DO ARAGUAIA	09/12/2020 08:31	09/12/2020 16:49	09/12/2020 08:31	09/12/2020 16:49	8,29	1	8,29	CHI
20201246811	EDEIA	1120033394	EDEIA	09/12/2020 08:32	09/12/2020 16:45	09/12/2020 08:32	09/12/2020 16:45	8,22	1	8,22	CHI
20201246815	CAIAPONIA	CP21134311	CAIAPONIA	09/12/2020 08:32	10/12/2020 02:03	09/12/2020 08:32	10/12/2020 02:03	17,51	1	17,51	CHI
20201246816	FLORES DE GOIAS	AQ12243035	IACIARA S2	09/12/2020 08:32	09/12/2020 19:22	09/12/2020 08:32	09/12/2020 19:22	10,83	2	21,65	CHI
20201246824	SANTA TEREZINHA DE GOIAS	SG21147639	SANTA TEREZINHA	09/12/2020 08:32	09/12/2020 13:49	09/12/2020 08:32	09/12/2020 13:49	5,27	1	5,27	CHI
20201246832	MARA ROSA	MQ12287615	MARA ROSA	09/12/2020 08:32	09/12/2020 14:25	09/12/2020 08:32	09/12/2020 14:25	5,87	4	23,49	CHI
20201246834	APARECIDA DE GOIANIA	17248267	ANHANGUERA	09/12/2020 08:32	09/12/2020 12:34	09/12/2020 08:32	09/12/2020 12:34	4,02	1	4,02	CHI

20201246868	GOIANIA	SW12060069	SENADOR CANEDO	09/12/2020 08:33	09/12/2020 14:33	09/12/2020 11:24	09/12/2020 14:33	3,15	2	6,30	CHI
20201247632	VILA PROPICIO	BA12064537	BARRO ALTO	09/12/2020 08:33	09/12/2020 16:19	09/12/2020 08:33	09/12/2020 16:19	7,76	2	15,51	CHI
20201247632	BARRO ALTO	BA12064537	BARRO ALTO	09/12/2020 08:33	09/12/2020 16:19	09/12/2020 08:33	09/12/2020 16:19	7,76	7	54,30	CHI
20201246849	JUSSARA	RN12045571	BRITANIA	09/12/2020 08:34	09/12/2020 16:34	09/12/2020 08:34	09/12/2020 16:34	8,00	4	31,99	CHI
20201246849	SANTA FE DE GOIAS	RN12045571	BRITANIA	09/12/2020 08:34	09/12/2020 16:34	09/12/2020 08:34	09/12/2020 16:34	8,00	6	47,98	CHI
20201246850	ITAGUARI	10012673828	ITABERAI S1	09/12/2020 08:34	09/12/2020 18:22	09/12/2020 08:34	09/12/2020 18:22	9,80	1	9,80	CHI
20201246859	GOIANIA	10014288603	CARAJAS S1	09/12/2020 08:35	09/12/2020 12:15	09/12/2020 08:35	09/12/2020 12:15	3,66	1	3,66	CHI
20201246863	CALDAS NOVAS	10032771124	SERRA DE CALDAS	09/12/2020 08:35	09/12/2020 10:31	09/12/2020 08:35	09/12/2020 10:31	1,92	1	1,92	CHI
20201246864	GAMELEIRA DE GOIAS	SV21125401	DAIA S2	09/12/2020 08:35	09/12/2020 20:58	09/12/2020 08:35	09/12/2020 20:58	12,37	1	12,37	CHI
20201246869	JATAI	JT11377836	JATAI S1	09/12/2020 08:36	09/12/2020 18:58	09/12/2020 08:36	09/12/2020 18:58	10,36	1	10,36	CHI
20201246872	MORRINHOS	RQ12182981	RIO QUENTE	09/12/2020 08:36	09/12/2020 09:16	09/12/2020 08:36	09/12/2020 09:16	0,66	1	0,66	CHI
20201246872	RIO QUENTE	RQ12182981	RIO QUENTE	09/12/2020 08:36	09/12/2020 09:16	09/12/2020 08:36	09/12/2020 09:16	0,66	54	35,61	CHI
20201246874	FIRMINOPOLIS	900008325	FIRMINOPOLIS S1	09/12/2020 08:37	09/12/2020 20:35	09/12/2020 08:37	09/12/2020 20:35	11,96	1	11,96	CHI
20201246875	RIO VERDE	RV12098479LD	RIO VERDE S1	09/12/2020 08:37	09/12/2020 19:26	09/12/2020 08:37	09/12/2020 19:26	10,81	7	75,70	CHI
20201246876	GOIANIA	SW12079061	GOIANIA LESTE S2	09/12/2020 08:37	09/12/2020 11:57	09/12/2020 08:37	09/12/2020 11:57	3,33	8	26,64	CHI
20201246878	NOVA CRIXAS	NA21251235	NOVA CRIXAS	09/12/2020 08:37	09/12/2020 14:59	09/12/2020 08:37	09/12/2020 14:59	6,36	1	6,36	CHI
20201246887	POSSE	PS21132520	IACIARA S2	09/12/2020 08:37	09/12/2020 16:04	09/12/2020 08:37	09/12/2020 16:04	7,44	1	7,44	CHI
20201246888	APARECIDA DE GOIANIA	200445029	ANHANGUERA	09/12/2020 08:37	09/12/2020 10:41	09/12/2020 08:37	09/12/2020 10:41	2,06	1	2,06	CHI
20201246896	DAVINOPOLIS	IO12394027	CATALAO S1	09/12/2020 08:38	09/12/2020 11:54	09/12/2020 08:38	09/12/2020 11:54	3,26	8	26,05	CHI
20201247025	JATAI	JT12303380RE	JATAI S1	09/12/2020 08:38	09/12/2020 10:50	09/12/2020 08:38	09/12/2020 10:50	2,20	26	57,13	CHI
20201246945	PEROLANDIA	DP21216540	JATAI S1	09/12/2020 08:40	10/12/2020 08:49	09/12/2020 08:40	10/12/2020 08:49	24,15	1	24,15	CHI
20201246951	ORIZONA	2060037470	PIRES DO RIO S2	09/12/2020 08:40	09/12/2020 14:00	09/12/2020 08:40	09/12/2020 14:00	5,32	1	5,32	CHI
20201247365	CAMPO ALEGRE DE GOIAS	CM12216102	CAMPO ALEGRE DE GOIAS	09/12/2020 08:40	09/12/2020 16:02	09/12/2020 08:40	09/12/2020 16:02	7,35	10	73,51	CHI
20201246956	LUZIANIA	LZ12353715	RIO VERMELHO	09/12/2020 08:41	09/12/2020 12:02	09/12/2020 08:41	09/12/2020 12:02	3,33	3	10,00	CHI
20201246957	MUTUNOPOLIS	MU21246502	MARA ROSA	09/12/2020 08:42	09/12/2020 15:01	09/12/2020 08:42	09/12/2020 15:01	6,32	1	6,32	CHI
20201248024	ITAGUARU	IC12300399	ITABERAI S1	09/12/2020 08:42	09/12/2020 12:58	09/12/2020 08:42	09/12/2020 12:58	4,25	0	0,00	CHI
20201248024	ITAGUARI	IC12300399	ITABERAI S1	09/12/2020 08:42	09/12/2020 12:58	09/12/2020 08:42	09/12/2020 12:58	4,25	8	34,02	CHI
20201248695	FAINA	FC12307520	GOIAS	09/12/2020 08:42	09/12/2020 12:15	09/12/2020 08:42	09/12/2020 12:15	3,55	6	21,27	CHI
20201249895	FAZENDA NOVA	NB12378824	JUSSARA	09/12/2020 08:42	09/12/2020 23:57	09/12/2020 08:42	09/12/2020 23:57	15,25	4	60,99	CHI
20201246970	CATALAO	CT11266187	CATALAO S1	09/12/2020 08:43	09/12/2020 14:26	09/12/2020 08:43	09/12/2020 14:26	5,71	53	302,54	CHI
20201246972	SANTA HELENA DE GOIAS	SH21301273	ACREUNA	09/12/2020 08:43	09/12/2020 17:37	09/12/2020 08:43	09/12/2020 17:37	8,91	1	8,91	CHI
20201246973	PIRANHAS	PH21201975	BOM JARDIM	09/12/2020 08:43	09/12/2020 16:01	09/12/2020 08:43	09/12/2020 16:01	7,29	1	7,29	CHI
20201246983	BELA VISTA DE GOIAS	BV31045549	BELA VISTA S1	09/12/2020 08:43	09/12/2020 10:51	09/12/2020 08:43	09/12/2020 10:51	2,12	1	2,12	CHI
20201247141	CORREGO DO OURO	CO12054694	SAO LUIZ DOS MONTES BELOS	09/12/2020 08:43	09/12/2020 11:41	09/12/2020 08:43	09/12/2020 11:41	2,97	12	35,59	CHI
20201247676	UIRAPURU	UP12244464	NOVA CRIXAS	09/12/2020 08:43	09/12/2020 11:30	09/12/2020 08:43	09/12/2020 11:30	2,78	24	66,75	CHI
20201246988	BOM JESUS DE GOIAS	BJ21088548	BOM JESUS DE GOIAS	09/12/2020 08:44	09/12/2020 12:37	09/12/2020 08:44	09/12/2020 12:37	3,88	1	3,88	CHI
20201246995	NIQUELANDIA	NQ12351186	NIQUELANDIA SUBTRANSMISSAO	09/12/2020 08:45	09/12/2020 20:10	09/12/2020 08:45	09/12/2020 20:10	11,42	8	91,35	CHI
20201247273	CROMINIA	CQ21079847	PONTALINA	09/12/2020 08:45	09/12/2020 12:23	09/12/2020 08:45	09/12/2020 12:23	3,62	1	3,62	CHI
20201248786	ALEXANIA	AX11334294	ALEXANIA	09/12/2020 08:45	09/12/2020 12:53	09/12/2020 08:45	09/12/2020 12:53	4,12	52	214,34	CHI
20201247009	INDIARA	IY21371641	EDEIA	09/12/2020 08:46	09/12/2020 13:14	09/12/2020 08:46	09/12/2020 13:14	4,46	2	8,92	CHI
20201247016	CACHOEIRA ALTA	CA21075133	CACHOEIRA ALTA	09/12/2020 08:46	09/12/2020 13:01	09/12/2020 08:46	09/12/2020 13:01	4,24	1	4,24	CHI
20201247021	FLORES DE GOIAS	FB11383395	FLORES DE GOIAS	09/12/2020 08:47	09/12/2020 14:21	09/12/2020 08:47	09/12/2020 14:21	5,56	37	205,61	CHI
20201247357	ESTRELA DO NORTE	ET11151072	MARA ROSA	09/12/2020 08:47	09/12/2020 16:56	09/12/2020 08:47	09/12/2020 16:56	8,14	138	1123,36	CHI
20201247030	LUZIANIA	LZ21330876	MARAJOARA	09/12/2020 08:49	09/12/2020 11:36	09/12/2020 08:49	09/12/2020 11:36	2,78	1	2,78	CHI
20201247033	FORMOSA	FA12383271	ITUIQUIRA	09/12/2020 08:49	09/12/2020 19:21	09/12/2020 08:49	09/12/2020 19:21	10,52	6	63,11	CHI
20201247037	CAMPOS VERDES	VD12243626	SANTA TEREZINHA	09/12/2020 08:50	09/12/2020 14:23	09/12/2020 08:50	09/12/2020 14:23	5,54	20	110,79	CHI
20201247046	APARECIDA DE GOIANIA	10022350312	INDEPENDENCIA S2	09/12/2020 08:51	09/12/2020 10:15	09/12/2020 08:51	09/12/2020 10:15	1,38	1	1,38	CHI
20201247050	APARECIDA DE GOIANIA	15841674	ATLANTICO S1	09/12/2020 08:52	09/12/2020 15:29	09/12/2020 08:52	09/12/2020 15:29	6,61	1	6,61	CHI
20201247054	GOIANIRA	IN12188645	INHUMAS S2	09/12/2020 08:52	09/12/2020 22:02	09/12/2020 08:52	09/12/2020 22:02	13,15	2	26,31	CHI
20201247194	ITAPIRAPUA	IU12087963	MATRINCHA	09/12/2020 08:52	09/12/2020 16:32	09/12/2020 08:52	09/12/2020 16:32	7,66	43	329,51	CHI
20201247057	SANTA RITA DO ARAGUAIA	SU11256927	SANTA RITA DO ARAGUAIA	09/12/2020 08:53	09/12/2020 11:51	09/12/2020 08:53	09/12/2020 11:51	2,97	1	2,97	CHI

20201241552	FORMOSA	FA12058455	SAO JOAO D ALIANCA	09/12/2020 08:54	09/12/2020 12:20	09/12/2020 08:54	09/12/2020 12:20	3,42	8	27,38	CHI
20201247068	LUZIANIA	LZ11370735	RIO VERMELHO	09/12/2020 08:54	09/12/2020 13:28	09/12/2020 08:54	09/12/2020 13:28	4,55	16	72,86	CHI
20201247749	JESUPOLIS	SF12066019	SAO FRANCISCO DE GOIAS	09/12/2020 08:55	09/12/2020 23:32	09/12/2020 08:55	09/12/2020 23:32	14,61	12	175,35	CHI
20201247749	SAO FRANCISCO DE GOIAS	SF12066019	SAO FRANCISCO DE GOIAS	09/12/2020 08:55	09/12/2020 23:32	09/12/2020 08:55	09/12/2020 23:32	14,61	10	146,13	CHI
20201247089	GOIANIA	GN11025839	GOIANIA LESTE S2	09/12/2020 08:56	09/12/2020 09:24	09/12/2020 08:56	09/12/2020 09:24	0,46	175	80,35	CHI
20201247118	CATALAO	CT12316068	CATALAO S2	09/12/2020 08:56	09/12/2020 12:32	09/12/2020 08:56	09/12/2020 12:32	3,59	11	39,45	CHI
20201247118	CUMARI	CT12316068	CATALAO S2	09/12/2020 08:56	09/12/2020 12:32	09/12/2020 08:56	09/12/2020 12:32	3,59	1	3,59	CHI
20201248553	SANTA CRUZ DE GOIAS	BC12311715	PIRES DO RIO S2	09/12/2020 08:56	09/12/2020 22:45	09/12/2020 08:56	09/12/2020 22:45	13,81	8	110,46	CHI
20201247088	QUIRINOPOLIS	QI12240420LD	SANTA HELENA S1	09/12/2020 08:57	09/12/2020 12:51	09/12/2020 08:57	09/12/2020 12:51	3,89	1	3,89	CHI
20201248266	MONTES CLAROS DE GOIAS	ME12204903	IPORA	09/12/2020 08:57	09/12/2020 13:18	09/12/2020 08:57	09/12/2020 13:18	4,35	3	13,04	CHI
20201247095	NOVO PLANALTO	TA11293667	SAO MIGUEL DO ARAGUAIA	09/12/2020 08:58	09/12/2020 10:28	09/12/2020 08:58	09/12/2020 10:28	1,49	1	1,49	CHI
20201247103	SAO SIMAO	SO11306221	CACHOEIRA ALTA	09/12/2020 08:59	09/12/2020 22:41	09/12/2020 08:59	09/12/2020 22:41	13,71	99	1357,24	CHI
20201247109	ITUMBIARA	IT12352760	PARANAIBA	09/12/2020 08:59	09/12/2020 19:41	09/12/2020 08:59	09/12/2020 19:41	10,69	4	42,74	CHI
20201251099	VILA PROPICIO	ZN12402010RE	COCALZINHO	09/12/2020 08:59	09/12/2020 19:50	09/12/2020 08:59	09/12/2020 19:50	10,84	1	10,84	CHI
20201251099	COCALZINHO DE GOIAS	ZN12402010RE	COCALZINHO	09/12/2020 08:59	09/12/2020 19:50	09/12/2020 08:59	09/12/2020 19:50	10,84	158	1712,11	CHI
20201247110	GOIANIA	10022937941	GOIANIA LESTE S1	09/12/2020 09:00	09/12/2020 10:15	09/12/2020 09:00	09/12/2020 10:15	1,25	1	1,25	CHI
20201247113	OURO VERDE DE GOIAS	OV21000023	NEROPOLIS S1	09/12/2020 09:00	09/12/2020 11:00	09/12/2020 09:00	09/12/2020 11:00	1,99	1	1,99	CHI
20201247114	ITABERAÍ	IB21259633	ITABERAÍ S1	09/12/2020 09:00	10/12/2020 03:55	09/12/2020 09:00	10/12/2020 03:55	18,91	1	18,91	CHI
20201247115	GOIAS	90104961	GOIAS	09/12/2020 09:00	09/12/2020 14:19	09/12/2020 09:00	09/12/2020 14:19	5,31	1	5,31	CHI
20201247120	SERRANOPOLIS	SX21166085	JATAI S1	09/12/2020 09:01	09/12/2020 15:05	09/12/2020 09:01	09/12/2020 15:05	6,06	1	6,06	CHI
20201247125	PARAUNA	PU12361906	PARAUNA	09/12/2020 09:02	10/12/2020 04:42	09/12/2020 09:02	10/12/2020 04:42	19,66	1	19,66	CHI
20201247142	FLORES DE GOIAS	FB21146194	IACIARA S2	09/12/2020 09:03	09/12/2020 15:23	09/12/2020 09:03	09/12/2020 15:23	6,32	1	6,32	CHI
20201247143	NOVA AMERICA	RB12251987	RUBIATABA	09/12/2020 09:03	09/12/2020 23:31	09/12/2020 09:03	09/12/2020 23:31	14,46	4	57,83	CHI
20201247143	RUBIATABA	RB12251987	RUBIATABA	09/12/2020 09:03	09/12/2020 23:31	09/12/2020 09:03	09/12/2020 23:31	14,46	6	86,74	CHI
20201247145	URUACU	UR21221679	URUACU	09/12/2020 09:03	09/12/2020 11:13	09/12/2020 09:03	09/12/2020 11:13	2,16	7	15,09	CHI
20201247146	PADRE BERNARDO	PB21201152	PADRE BERNARDO	09/12/2020 09:03	09/12/2020 13:03	09/12/2020 09:03	09/12/2020 13:03	3,99	1	3,99	CHI
20201247296	ARUANA	O3200434	ARUANA	09/12/2020 09:03	09/12/2020 09:24	09/12/2020 09:03	09/12/2020 09:24	0,35	6	2,10	CHI
20201247296	ARUANA	O3200414	BRITANIA	09/12/2020 09:03	09/12/2020 09:24	09/12/2020 09:03	09/12/2020 09:24	0,35	12	4,20	CHI
20201247148	MINACU	IH21187760	MINACU	09/12/2020 09:04	11/12/2020 09:21	09/12/2020 09:04	11/12/2020 09:21	48,28	2	96,56	CHI
20201247160	SILVANIA	SV12330380	DAIA S2	09/12/2020 09:05	10/12/2020 12:02	09/12/2020 09:05	10/12/2020 12:02	26,95	2	53,89	CHI
20201247163	SANTA TEREZINHA DE GOIAS	SG12134503	SANTA TEREZINHA	09/12/2020 09:05	09/12/2020 15:47	09/12/2020 09:05	09/12/2020 15:47	6,69	1	6,69	CHI
20201247166	NIQUELANDIA	NQ21345064	NIQUELANDIA SUBTRANSMISSAO	09/12/2020 09:05	09/12/2020 13:12	09/12/2020 09:05	09/12/2020 13:12	4,11	1	4,11	CHI
20201247169	SANTA TEREZINHA DE GOIAS	VD12265513	SANTA TEREZINHA	09/12/2020 09:06	10/12/2020 11:01	09/12/2020 09:06	10/12/2020 11:01	25,92	2	51,83	CHI
20201247169	CAMPOS VERDES	VD12265513	SANTA TEREZINHA	09/12/2020 09:06	10/12/2020 11:01	09/12/2020 09:06	10/12/2020 11:01	25,92	2	51,83	CHI
20201247172	EDEALINA	PK12263505RE	PONTALINA	09/12/2020 09:06	09/12/2020 10:42	09/12/2020 09:06	09/12/2020 10:42	1,60	3	4,79	CHI
20201247172	PONTALINA	PK12263505RE	PONTALINA	09/12/2020 09:06	09/12/2020 10:42	09/12/2020 09:06	09/12/2020 10:42	1,60	21	33,51	CHI
20201248417	MUNDO NOVO DE GOIAS	MH12269058	NOVA CRIXAS	09/12/2020 09:06	09/12/2020 14:28	09/12/2020 09:06	09/12/2020 14:28	5,36	59	316,04	CHI
20201249981	CORREGO DO OURO	CO12237031	FIRMINOPOLIS S2	09/12/2020 09:06	10/12/2020 01:56	09/12/2020 09:06	10/12/2020 01:56	16,83	3	50,48	CHI
20201247183	CORUMBAIBA	CI21283288	VILA CORUMBA	09/12/2020 09:07	10/12/2020 17:51	09/12/2020 09:07	10/12/2020 17:51	32,73	1	32,73	CHI
20201247189	TROMBAS	TB21146529	PORANGATU	09/12/2020 09:07	09/12/2020 21:22	09/12/2020 09:07	09/12/2020 21:22	12,24	2	24,48	CHI
20201247191	SERRANOPOLIS	3000027164	JATAI S1	09/12/2020 09:07	09/12/2020 20:47	09/12/2020 09:07	09/12/2020 20:47	11,66	1	11,66	CHI
20201247209	SAO SIMAO	SO21255766	CACHOEIRA ALTA	09/12/2020 09:09	09/12/2020 20:37	09/12/2020 09:09	09/12/2020 20:37	11,46	1	11,46	CHI
20201247221	CAMPINORTE	CR12051895RE	MARA ROSA	09/12/2020 09:11	09/12/2020 16:43	09/12/2020 09:11	09/12/2020 16:43	7,53	18	135,60	CHI
20201247221	NOVA IGUAÇU DE GOIAS	CR12051895RE	MARA ROSA	09/12/2020 09:11	09/12/2020 16:43	09/12/2020 09:11	09/12/2020 16:43	7,53	17	128,07	CHI
20201247226	GOIANIA	10276350	CAMPINAS S2	09/12/2020 09:11	09/12/2020 16:32	09/12/2020 09:11	09/12/2020 16:32	7,34	1	7,34	CHI
20201247232	PARAUNA	PU21118478	FIRMINOPOLIS S2	09/12/2020 09:11	09/12/2020 16:05	09/12/2020 09:11	09/12/2020 16:05	6,90	1	6,90	CHI
20201247234	CALDAS NOVAS	CN11248171	SERRA DE CALDAS	09/12/2020 09:11	09/12/2020 17:35	09/12/2020 09:11	09/12/2020 17:35	8,39	97	813,86	CHI
2020120900035	JARAGUA	O1020214	JARAGUA	09/12/2020 09:11	09/12/2020 09:49	09/12/2020 09:11	09/12/2020 09:49	0,63	9009	5705,70	CHI
2020120900035	URUANA	O1020214	JARAGUA	09/12/2020 09:11	09/12/2020 09:49	09/12/2020 09:11	09/12/2020 09:49	0,63	7	4,43	CHI
2020120900035	ITAGUARU	O1020214	JARAGUA	09/12/2020 09:11	09/12/2020 09:49	09/12/2020 09:11	09/12/2020 09:49	0,63	26	16,47	CHI
2020120900035	PIRENOPOLIS	O1020214	JARAGUA	09/12/2020 09:11	09/12/2020 09:49	09/12/2020 09:11	09/12/2020 09:49	0,63	98	62,07	CHI

202012090035	JARAGUA	01020224	JARAGUA	09/12/2020 09:11	09/12/2020 09:49	09/12/2020 09:11	09/12/2020 09:49	0,63	9313	5898,23	CHI
202012090035	PIRENOPOLIS	01020224	JARAGUA	09/12/2020 09:11	09/12/2020 09:49	09/12/2020 09:11	09/12/2020 09:49	0,63	55	34,83	CHI
20201247237	HIDROLANDIA	HD12000148	PONTALINA	09/12/2020 09:12	09/12/2020 13:51	09/12/2020 09:12	09/12/2020 13:51	4,65	1	4,65	CHI
20201247240	SAO FRANCISCO DE GOIAS	PV21230763	SAO FRANCISCO DE GOIAS	09/12/2020 09:12	09/12/2020 11:41	09/12/2020 09:12	09/12/2020 11:41	2,48	1	2,48	CHI
20201247242	ALTO PARAISO DE GOIAS	BF12072307	SAO JOAO D ALIANCA	09/12/2020 09:12	09/12/2020 19:18	09/12/2020 09:12	09/12/2020 19:18	10,09	1	10,09	CHI
20201247245	CRISTALINA	KR12209482	CRISTALINA S1	09/12/2020 09:12	09/12/2020 15:01	09/12/2020 09:12	09/12/2020 15:01	5,80	1	5,80	CHI
20201247247	NIQUELANDIA	NQ12396793	NIQUELANDIA SUBTRANSMISSAO	09/12/2020 09:12	09/12/2020 11:51	09/12/2020 09:12	09/12/2020 11:51	2,64	5	13,18	CHI
20201248558	NIQUELANDIA	NQ12248223	URUACU	09/12/2020 09:12	09/12/2020 13:37	09/12/2020 09:12	09/12/2020 13:37	4,40	9	39,63	CHI
20201247250	CALDAS NOVAS	CN12212735LD	RIO QUENTE	09/12/2020 09:13	09/12/2020 13:50	09/12/2020 09:13	09/12/2020 13:50	4,61	65	299,67	CHI
20201247250	PIRACANJUBA	CN12212735LD	RIO QUENTE	09/12/2020 09:13	09/12/2020 13:50	09/12/2020 09:13	09/12/2020 13:50	4,61	1	4,61	CHI
20201247250	MORRINHOS	CN12212735LD	RIO QUENTE	09/12/2020 09:13	09/12/2020 13:50	09/12/2020 09:13	09/12/2020 13:50	4,61	1	4,61	CHI
20201247256	PALMINOPOLIS	PP21060469	PALMEIRAS	09/12/2020 09:13	09/12/2020 12:11	09/12/2020 09:13	09/12/2020 12:11	2,95	1	2,95	CHI
20201247258	CACHOEIRA DOURADA	CD21000050	CACHOEIRA DOURADA	09/12/2020 09:13	09/12/2020 18:48	09/12/2020 09:13	09/12/2020 18:48	9,57	1	9,57	CHI
20201247260	CALDAZINHA	SW21080142	CEPAIGO S2	09/12/2020 09:14	10/12/2020 01:06	09/12/2020 09:14	10/12/2020 01:06	15,87	1	15,87	CHI
20201247418	ITAGUARU	IC11089314	ITABERAI S1	09/12/2020 09:14	09/12/2020 17:42	09/12/2020 09:14	09/12/2020 17:42	8,46	73	617,94	CHI
20201247277	SENADOR CANEDO	15127310	GOIANIA LESTE S1	09/12/2020 09:15	09/12/2020 11:48	09/12/2020 09:15	09/12/2020 11:48	2,54	1	2,54	CHI
20201247279	GOIANIA	10153410	GOIANIA LESTE S1	09/12/2020 09:15	09/12/2020 10:38	09/12/2020 09:15	09/12/2020 10:38	1,37	1	1,37	CHI
20201247280	ITAGUARI	II21222090	ITABERAI S1	09/12/2020 09:15	09/12/2020 13:47	09/12/2020 09:15	09/12/2020 13:47	4,52	1	4,52	CHI
20201247905	FAINA	FC12307361	GOIAS	09/12/2020 09:15	09/12/2020 15:24	09/12/2020 09:15	09/12/2020 15:24	6,15	41	252,13	CHI
20201249173	SERRANOPOLIS	SX12037674	JATAI S1	09/12/2020 09:15	09/12/2020 19:03	09/12/2020 09:15	09/12/2020 19:03	9,79	38	372,02	CHI
20201247288	BURITI ALEGRE	420002212	ALTO BURITI	09/12/2020 09:16	09/12/2020 17:09	09/12/2020 09:16	09/12/2020 17:09	7,88	1	7,88	CHI
20201247291	ITAUUCU	IX12320362	INHUMAS S1	09/12/2020 09:16	09/12/2020 16:54	09/12/2020 09:16	09/12/2020 16:54	7,63	4	30,50	CHI
20201247294	TURVANIA	TV12259071	FIRMINOPOLIS S2	09/12/2020 09:16	09/12/2020 15:39	09/12/2020 09:16	09/12/2020 15:39	6,37	7	44,58	CHI
20201249744	SANTA CRUZ DE GOIAS	CN12331858	CALDAS NOVAS S1	09/12/2020 09:16	11/12/2020 11:52	09/12/2020 09:16	11/12/2020 11:52	50,59	8	404,71	CHI
20201247598	ITABERAI	AR12019598	ARACU	09/12/2020 09:17	10/12/2020 20:00	09/12/2020 09:17	09/12/2020 11:35	2,30	12	27,57	CHI
20201247598	ARACU	AR12019598	ARACU	09/12/2020 09:17	10/12/2020 20:00	09/12/2020 09:17	09/12/2020 11:35	2,30	7	16,08	CHI
20201247598	ARACU	AR12019598	ARACU	09/12/2020 09:17	10/12/2020 20:00	09/12/2020 11:38	09/12/2020 15:45	4,10	5	20,52	CHI
20201247598	ITABERAI	AR12019598	ARACU	09/12/2020 09:17	10/12/2020 20:00	09/12/2020 11:38	09/12/2020 15:45	4,10	11	45,14	CHI
20201247598	ITABERAI	6231919	ARACU	09/12/2020 09:17	10/12/2020 20:00	09/12/2020 11:38	10/12/2020 20:00	32,35	1	32,35	CHI
20201247598	ARACU	6231919	ARACU	09/12/2020 09:17	10/12/2020 20:00	09/12/2020 11:38	10/12/2020 20:00	32,35	2	64,71	CHI
20201248533	SENADOR CANEDO	SW12092633LD	SENADOR CANEDO	09/12/2020 09:17	09/12/2020 13:51	09/12/2020 09:17	09/12/2020 13:51	4,56	20	91,12	CHI
20201250022	CARMO DO RIO VERDE	IK12170874	ITAPURANGA	09/12/2020 09:17	09/12/2020 20:24	09/12/2020 09:17	09/12/2020 20:24	11,11	12	133,29	CHI
20201250670	SANTO ANTONIO DO DESCOBERTO	SN12064481LD	MARAJOARA	09/12/2020 09:17	09/12/2020 22:50	09/12/2020 09:17	09/12/2020 22:50	13,54	50	676,81	CHI
20201248465	ARUANA	AK12066606	ARUANA	09/12/2020 09:18	10/12/2020 09:17	09/12/2020 09:18	10/12/2020 09:17	23,97	3	71,92	CHI
20201249156	FAINA	MP12299739	MATRINCHA	09/12/2020 09:18	09/12/2020 23:05	09/12/2020 09:18	09/12/2020 23:05	13,77	9	123,91	CHI
20201249156	MATRINCHA	MP12299739	MATRINCHA	09/12/2020 09:18	09/12/2020 23:05	09/12/2020 09:18	09/12/2020 23:05	13,77	6	82,61	CHI
20201250186	HEITORAI	HE12390849	ITAPURANGA	09/12/2020 09:18	10/12/2020 11:33	09/12/2020 09:18	10/12/2020 11:33	26,26	30	787,70	CHI
20201250186	ITAPURANGA	HE12390849	ITAPURANGA	09/12/2020 09:18	10/12/2020 11:33	09/12/2020 09:18	10/12/2020 11:33	26,26	1	26,26	CHI
20201250525	FAINA	FC12057965	GOIAS	09/12/2020 09:18	10/12/2020 11:03	09/12/2020 09:18	10/12/2020 11:03	25,74	6	154,44	CHI
20201247327	TRINDADE	TR12344887	TRINDADE	09/12/2020 09:19	09/12/2020 12:26	09/12/2020 09:19	09/12/2020 12:26	3,11	11	34,16	CHI
20201247327	GOIANIRA	TR12344887	TRINDADE	09/12/2020 09:19	09/12/2020 12:26	09/12/2020 09:19	09/12/2020 12:26	3,11	1	3,11	CHI
20201247328	CAIAPONIA	CP12248981	CAIAPONIA	09/12/2020 09:19	09/12/2020 20:03	09/12/2020 09:19	09/12/2020 20:03	10,72	7	75,04	CHI
20201247330	CALDAS NOVAS	760264340	SERRA DE CALDAS	09/12/2020 09:20	09/12/2020 19:00	09/12/2020 09:20	09/12/2020 19:00	9,66	1	9,66	CHI
20201247333	SANTO ANTONIO DO DESCOBERTO	LZ21000543	MARAJOARA	09/12/2020 09:20	09/12/2020 18:36	09/12/2020 09:20	09/12/2020 18:36	9,26	1	9,26	CHI
20201247336	ANAPOLIS	20863550	ANAPOLIS UNIVERSITARIO S2	09/12/2020 09:20	09/12/2020 16:05	09/12/2020 09:20	09/12/2020 16:05	6,74	1	6,74	CHI
20201247339	TRINDADE	40217796	TRINDADE	09/12/2020 09:20	09/12/2020 11:25	09/12/2020 09:20	09/12/2020 11:25	2,07	1	2,07	CHI
20201247342	HIDROLANDIA	HD12093305LD	CEPAIGO S2	09/12/2020 09:21	10/12/2020 01:15	09/12/2020 09:21	10/12/2020 01:15	15,90	4	63,59	CHI
20201247342	BELA VISTA DE GOIAS	HD12093305LD	CEPAIGO S2	09/12/2020 09:21	10/12/2020 01:15	09/12/2020 09:21	10/12/2020 01:15	15,90	1	15,90	CHI
20201247349	VILA BOA	10002507453	IACIARA S2	09/12/2020 09:21	09/12/2020 12:58	09/12/2020 09:21	09/12/2020 12:58	3,62	1	3,62	CHI
20201248247	CAMPO ALEGRE DE GOIAS	CM12166727	CAMPO ALEGRE DE GOIAS	09/12/2020 09:21	10/12/2020 00:38	09/12/2020 09:21	10/12/2020 00:38	15,27	6	91,64	CHI
20201248635	ARAGUAPAZ	AZ12205045	GOIAS	09/12/2020 09:21	09/12/2020 17:13	09/12/2020 09:21	09/12/2020 17:13	7,86	4	31,43	CHI

20201247359	CRISTALINA	KR21163077	CRISTALINA S2	09/12/2020 09:22	09/12/2020 15:36	09/12/2020 09:22	09/12/2020 15:36	6,22	1	6,22	CHI
20201247363	ANAPOLIS	AN11089460	ANAPOLIS UNIVERSITARIO S2	09/12/2020 09:22	09/12/2020 14:35	09/12/2020 09:22	09/12/2020 14:35	5,20	45	234,10	CHI
20201247364	APARECIDA DE GOIANIA	10008656744	ANHANGUERA	09/12/2020 09:23	09/12/2020 12:23	09/12/2020 09:23	09/12/2020 12:23	3,00	1	3,00	CHI
20201247373	NAZARIO	PL12000123	PALMEIRAS	09/12/2020 09:24	09/12/2020 12:40	09/12/2020 09:24	09/12/2020 12:40	3,26	2	6,53	CHI
20201247377	JATAI	JT12348816	JATAI S1	09/12/2020 09:24	09/12/2020 11:44	09/12/2020 09:24	09/12/2020 11:44	2,32	2	4,65	CHI
20201247378	MORRINHOS	MR21011820	MORRINHOS	09/12/2020 09:24	09/12/2020 19:37	09/12/2020 09:24	09/12/2020 19:37	10,21	2	20,41	CHI
20201247380	ALEXANIA	480050776	ALEXANIA	09/12/2020 09:24	09/12/2020 18:08	09/12/2020 09:24	09/12/2020 18:08	8,72	1	8,72	CHI
20201248151	LUZIANIA	LZ12290771	MARAJOARA	09/12/2020 09:24	09/12/2020 14:51	09/12/2020 09:24	09/12/2020 14:51	5,44	32	174,11	CHI
20201247386	PIRACANJUBA	PJ21106700	PIRACANJUBA	09/12/2020 09:25	10/12/2020 07:12	09/12/2020 09:25	10/12/2020 07:12	21,78	1	21,78	CHI
20201247521	JATAI	JT12354961	JATAI S1	09/12/2020 09:25	09/12/2020 13:01	09/12/2020 09:25	09/12/2020 13:01	3,59	16	57,47	CHI
20201248168	NOVA CRIXAS	NA12035650	NOVA CRIXAS	09/12/2020 09:25	09/12/2020 19:28	09/12/2020 09:25	09/12/2020 19:28	10,04	24	241,03	CHI
20201248168	MUNDO NOVO DE GOIAS	NA12035650	NOVA CRIXAS	09/12/2020 09:25	09/12/2020 19:28	09/12/2020 09:25	09/12/2020 19:28	10,04	8	80,34	CHI
20201248977	LEOPOLDO DE BULHOES	LB12026675	DAIA S2	09/12/2020 09:25	09/12/2020 18:24	09/12/2020 09:25	09/12/2020 18:24	8,97	4	35,87	CHI
20201247403	PORANGATU	PO12365601	NOVO PLANALTO	09/12/2020 09:27	09/12/2020 13:02	09/12/2020 09:27	09/12/2020 13:02	3,58	4	14,31	CHI
20201247405	CORUMBA DE GOIAS	CB12382148	CORUMBA	09/12/2020 09:27	09/12/2020 13:32	09/12/2020 09:27	09/12/2020 13:32	4,08	3	12,23	CHI
20201247408	AMARALINA	LC12270742	SAO MIGUEL DO ARAGUAIA	09/12/2020 09:27	09/12/2020 13:15	09/12/2020 09:27	09/12/2020 13:15	3,79	4	15,16	CHI
20201247412	SAO MIGUEL DO ARAGUAIA	SM21147668	SAO MIGUEL DO ARAGUAIA	09/12/2020 09:27	09/12/2020 23:11	09/12/2020 09:27	09/12/2020 23:11	13,72	1	13,72	CHI
20201247413	PORANGATU	PO21230388	PORANGATU	09/12/2020 09:28	09/12/2020 11:35	09/12/2020 09:28	09/12/2020 11:35	2,12	1	2,12	CHI
20201247414	BURITI ALEGRE	BG12066316	ITUMBIARA VELHA S2	09/12/2020 09:28	09/12/2020 18:25	09/12/2020 09:28	09/12/2020 18:25	8,95	1	8,95	CHI
20201247417	GOIANIA	11152503	CAMPINAS S1	09/12/2020 09:28	09/12/2020 15:12	09/12/2020 09:28	09/12/2020 15:12	5,73	1	5,73	CHI
20201247429	BARRO ALTO	BA21342222	GOIANESIA S1	09/12/2020 09:30	09/12/2020 14:33	09/12/2020 09:30	09/12/2020 14:33	5,05	1	5,05	CHI
20201247431	IPORA	IR21358549	IPORA	09/12/2020 09:30	09/12/2020 15:14	09/12/2020 09:30	09/12/2020 15:14	5,73	1	5,73	CHI
20201247432	BALIZA	BH12204858	BOM JARDIM	09/12/2020 09:30	09/12/2020 11:04	09/12/2020 09:30	09/12/2020 11:04	1,56	5	7,79	CHI
20201247433	MORRO AGUDO DE GOIAS	RB12026407	ITAPURANGA	09/12/2020 09:30	09/12/2020 17:47	09/12/2020 09:30	09/12/2020 17:47	8,28	2	16,55	CHI
20201247435	HIDROLANDIA	10008048507	ANHANGUERA	09/12/2020 09:30	09/12/2020 12:41	09/12/2020 09:30	09/12/2020 12:41	3,17	1	3,17	CHI
20201247436	IPAMERI	UT12027074	URUTAI	09/12/2020 09:30	09/12/2020 11:47	09/12/2020 09:30	09/12/2020 11:47	2,27	44	99,87	CHI
20201247436	URUTAI	UT12027074	URUTAI	09/12/2020 09:30	09/12/2020 11:47	09/12/2020 09:30	09/12/2020 11:47	2,27	9	20,43	CHI
20201247440	SILVANIA	660037142	VIANOPOLIS	09/12/2020 09:31	10/12/2020 02:12	09/12/2020 09:31	10/12/2020 02:12	16,68	1	16,68	CHI
20201247441	ARAGUAPAZ	AZ21235387	GOIAS	09/12/2020 09:31	09/12/2020 11:40	09/12/2020 09:31	09/12/2020 11:40	2,14	1	2,14	CHI
20201247442	HIDROLANDIA	180045179	ANHANGUERA	09/12/2020 09:31	09/12/2020 14:39	09/12/2020 09:31	09/12/2020 14:39	5,12	1	5,12	CHI
20201247443	ITAGUARI	770008938	ITABERAI S1	09/12/2020 09:31	09/12/2020 17:21	09/12/2020 09:31	09/12/2020 17:21	7,82	1	7,82	CHI
20201247448	ANAPOLIS	10007531980	JUNDIAI S2	09/12/2020 09:32	09/12/2020 19:52	09/12/2020 09:32	09/12/2020 19:52	10,33	1	10,33	CHI
20201247449	GOIANIA	16557177	CAMPINAS S2	09/12/2020 09:32	09/12/2020 11:43	09/12/2020 09:32	09/12/2020 11:43	2,18	1	2,18	CHI
20201247460	ANAPOLIS	20817540	ANAPOLIS UNIVERSITARIO S2	09/12/2020 09:33	09/12/2020 11:49	09/12/2020 09:33	09/12/2020 11:49	2,25	1	2,25	CHI
20201247696	ANAPOLIS	AN13370350	ANAPOLIS UNIVERSITARIO S2	09/12/2020 09:33	09/12/2020 14:42	09/12/2020 12:53	09/12/2020 14:41	1,79	1	1,79	CHI
20201247696	ANAPOLIS	AN11000366	ANAPOLIS UNIVERSITARIO S2	09/12/2020 09:33	09/12/2020 14:42	09/12/2020 09:33	09/12/2020 14:42	5,14	98	503,23	CHI
20201247463	APARECIDA DE GOIANIA	200235588	INDEPENDENCIA S2	09/12/2020 09:34	09/12/2020 13:11	09/12/2020 09:34	09/12/2020 13:11	3,61	1	3,61	CHI
20201247468	GOIANIA	10007998994	CARAJAS S1	09/12/2020 09:34	09/12/2020 15:45	09/12/2020 09:34	09/12/2020 15:45	6,17	1	6,17	CHI
20201249443	MUNDO NOVO DE GOIAS	MH11274858	NOVA CRIXAS	09/12/2020 09:34	09/12/2020 16:53	09/12/2020 09:34	09/12/2020 16:53	7,31	1	7,31	CHI
20201247477	CALDAZINHA	BV21161600	CEPAIGO S2	09/12/2020 09:35	09/12/2020 15:54	09/12/2020 09:35	09/12/2020 15:54	6,31	2	12,62	CHI
20201247491	ITAPIRAPUA	IU12260001	MATRINCHA	09/12/2020 09:36	09/12/2020 15:56	09/12/2020 09:36	09/12/2020 15:56	6,33	2	12,65	CHI
20201247498	GOIANIA	12150976	CARAJAS S1	09/12/2020 09:36	09/12/2020 13:02	09/12/2020 09:36	09/12/2020 13:02	3,42	1	3,42	CHI
20201247502	GOIATUBA	GT12048509	GOIATUBA S2	09/12/2020 09:37	09/12/2020 23:09	09/12/2020 09:37	09/12/2020 23:09	13,52	2	27,05	CHI
20201247510	COLINAS DO SUL	CJ21163047	NIQUELANDIA SUBTRANSMISSAO	09/12/2020 09:38	09/12/2020 21:26	09/12/2020 09:38	09/12/2020 21:26	11,79	1	11,79	CHI
20201247511	LUZIANIA	120173750	RIO VERMELHO	09/12/2020 09:38	09/12/2020 14:04	09/12/2020 09:38	09/12/2020 14:04	4,43	1	4,43	CHI
20201247513	TRINDADE	11687812	GOYA S2	09/12/2020 09:38	09/12/2020 15:08	09/12/2020 09:38	09/12/2020 15:08	5,50	1	5,50	CHI
20201247547	OURO VERDE DE GOIAS	OV12384176	NEROPOLIS S1	09/12/2020 09:38	09/12/2020 11:16	09/12/2020 09:38	09/12/2020 11:16	1,63	11	17,95	CHI
20201251382	MONTIVIDIU	MV12305995	MONTIVIDIU T	09/12/2020 09:38	10/12/2020 01:13	09/12/2020 09:38	10/12/2020 01:13	15,58	28	436,13	CHI
20201251382	IVOLANDIA	MV12305995	MONTIVIDIU T	09/12/2020 09:38	10/12/2020 01:13	09/12/2020 09:38	10/12/2020 01:13	15,58	28	436,13	CHI
20201251382	CAIAPONIA	MV12305995	MONTIVIDIU T	09/12/2020 09:38	10/12/2020 01:13	09/12/2020 09:38	10/12/2020 01:13	15,58	39	607,47	CHI
20201251382	PARAUNA	MV12305995	MONTIVIDIU T	09/12/2020 09:38	10/12/2020 01:13	09/12/2020 09:38	10/12/2020 01:13	15,58	61	950,14	CHI

20201247517	APARECIDA DE GOIANIA	10027109060	INDEPENDENCIA S1	09/12/2020 09:39	09/12/2020 12:14	09/12/2020 09:39	09/12/2020 12:14	2,58	1	2,58	CHI
20201247635	CATALAO	CT12250354	CATALAO S1	09/12/2020 09:39	09/12/2020 13:46	09/12/2020 09:39	09/12/2020 13:46	4,11	15	61,58	CHI
20201247529	ANAPOLIS	20096653	JUNDIAI S2	09/12/2020 09:40	10/12/2020 00:41	09/12/2020 09:40	10/12/2020 00:41	15,01	1	15,01	CHI
20201247532	ALTO PARAISO DE GOIAS	BF21265759	FLORES DE GOIAS	09/12/2020 09:40	09/12/2020 22:00	09/12/2020 09:40	09/12/2020 22:00	12,32	1	12,32	CHI
2020120900036	ARUANA	03200414	BRITANIA	09/12/2020 09:40	09/12/2020 09:45	09/12/2020 09:40	09/12/2020 09:45	0,08	12	1,00	CHI
2020120900036	ARUANA	03200434	ARUANA	09/12/2020 09:40	09/12/2020 09:45	09/12/2020 09:40	09/12/2020 09:45	0,08	7	0,58	CHI
20201247539	PADRE BERNARDO	9980018762	PADRE BERNARDO	09/12/2020 09:42	09/12/2020 13:02	09/12/2020 09:42	09/12/2020 13:02	3,33	1	3,33	CHI
20201247544	APARECIDA DE GOIANIA	10014771100	ANHANGUERA	09/12/2020 09:43	09/12/2020 12:17	09/12/2020 09:43	09/12/2020 12:17	2,56	1	2,56	CHI
20201247549	NOVA IGUACU DE GOIAS	NH12202119	CAMPINORTE	09/12/2020 09:43	09/12/2020 12:32	09/12/2020 09:43	09/12/2020 12:32	2,81	8	22,46	CHI
20201247553	GOIANIA	15547528	CAMPINAS S3	09/12/2020 09:43	09/12/2020 16:11	09/12/2020 09:43	09/12/2020 16:11	6,45	1	6,45	CHI
20201248088	ANAPOLIS	AN12000092	ANAPOLIS UNIVERSITARIO S2	09/12/2020 09:43	09/12/2020 15:43	09/12/2020 09:43	09/12/2020 15:43	5,98	153	915,58	CHI
20201243455	NOVA CRIXAS	NA18213169FS	NOVA CRIXAS	09/12/2020 09:44	11/12/2020 13:38	09/12/2020 09:44	09/12/2020 10:30	0,76	18	13,74	CHI
20201243455	NOVA CRIXAS	NA18213169FS	NOVA CRIXAS	09/12/2020 09:44	11/12/2020 13:38	09/12/2020 11:17	09/12/2020 21:18	10,03	6	60,15	CHI
20201243455	NOVA CRIXAS	NA18213169FS	NOVA CRIXAS	09/12/2020 09:44	11/12/2020 13:38	09/12/2020 11:17	11/12/2020 13:18	50,02	11	550,20	CHI
20201243455	NOVA CRIXAS	NA13110894	NOVA CRIXAS	09/12/2020 09:44	11/12/2020 13:38	09/12/2020 11:17	11/12/2020 13:38	50,36	1	50,36	CHI
20201247558	GOIANIA	15973839	AEROPORTO S1	09/12/2020 09:44	09/12/2020 11:45	09/12/2020 09:44	09/12/2020 11:45	2,01	1	2,01	CHI
20201247560	CAMPINORTE	CR12266635	MARA ROSA	09/12/2020 09:44	10/12/2020 02:23	09/12/2020 09:44	10/12/2020 02:23	16,64	6	99,86	CHI
20201247561	NOVA CRIXAS	8570008419	NOVA CRIXAS	09/12/2020 09:44	09/12/2020 15:36	09/12/2020 09:44	09/12/2020 15:36	5,86	1	5,86	CHI
20201247562	GOIANIA	12405619	GOYA S2	09/12/2020 09:44	09/12/2020 11:11	09/12/2020 09:44	09/12/2020 11:11	1,44	1	1,44	CHI
20201252424	FAZENDA NOVA	FN12113973	IPORA	09/12/2020 09:45	10/12/2020 14:23	09/12/2020 09:45	10/12/2020 14:23	28,62	10	286,19	CHI
20201252424	ISRAELANDIA	FN12113973	IPORA	09/12/2020 09:45	10/12/2020 14:23	09/12/2020 09:45	10/12/2020 14:23	28,62	2	57,24	CHI
20201247582	ITUMBIAIRA	10005711582	PARANAIBA	09/12/2020 09:46	09/12/2020 18:03	09/12/2020 09:46	09/12/2020 18:03	8,27	1	8,27	CHI
20201247587	NOVO GAMA	2460080044	PACAEMBU S1	09/12/2020 09:47	09/12/2020 11:26	09/12/2020 09:47	09/12/2020 11:26	1,64	1	1,64	CHI
20201250917	GOIATUBA	GT21254406	VICENTINOPOLIS	09/12/2020 09:47	09/12/2020 19:46	09/12/2020 09:47	09/12/2020 19:46	9,98	1	9,98	CHI
20201247592	RUBIATABA	RB21194737	RUBIATABA	09/12/2020 09:48	10/12/2020 00:11	09/12/2020 09:48	10/12/2020 00:11	14,37	1	14,37	CHI
20201242782	LUZIANIA	LZ12376188	RIO VERMELHO	09/12/2020 09:49	09/12/2020 13:18	09/12/2020 09:49	09/12/2020 13:18	3,48	10	34,81	CHI
20201247596	SAO MIGUEL DO ARAGUAIA	SM11332462	SAO MIGUEL DO ARAGUAIA	09/12/2020 09:49	09/12/2020 21:26	09/12/2020 09:49	09/12/2020 21:26	11,61	1	11,61	CHI
20201247599	CALDAS NOVAS	760140418	SERRA DE CALDAS	09/12/2020 09:49	09/12/2020 13:03	09/12/2020 09:49	09/12/2020 13:03	3,24	1	3,24	CHI
20201247605	JANDAIA	JD21158966	PALMEIRAS	09/12/2020 09:50	09/12/2020 17:29	09/12/2020 09:50	09/12/2020 17:29	7,64	1	7,64	CHI
20201247608	BELA VISTA DE GOIAS	BV31127769	BELA VISTA S1	09/12/2020 09:50	09/12/2020 11:55	09/12/2020 09:50	09/12/2020 11:55	2,07	1	2,07	CHI
20201248670	SAO MIGUEL DO ARAGUAIA	SM12252091	SAO MIGUEL DO ARAGUAIA	09/12/2020 09:50	10/12/2020 20:11	09/12/2020 09:50	09/12/2020 20:11	10,34	61	630,60	CHI
20201252136	PONTALINA	PK32041751	PONTALINA	09/12/2020 09:50	10/12/2020 08:46	09/12/2020 09:50	10/12/2020 08:46	22,92	4	91,69	CHI
20201252136	MAIRIPOTABA	PK32041751	PONTALINA	09/12/2020 09:50	10/12/2020 08:46	09/12/2020 20:23	10/12/2020 08:46	12,38	7	86,67	CHI
20201252136	PONTALINA	PK32041751	PONTALINA	09/12/2020 09:50	10/12/2020 08:46	09/12/2020 20:23	10/12/2020 08:46	12,38	192	2377,28	CHI
20201247611	URUACU	640045182	URUACU	09/12/2020 09:51	09/12/2020 19:48	09/12/2020 09:51	09/12/2020 19:48	9,95	1	9,95	CHI
20201247615	LUZIANIA	10016437770	RIO VERMELHO	09/12/2020 09:51	09/12/2020 11:45	09/12/2020 09:51	09/12/2020 11:45	1,89	1	1,89	CHI
20201247616	CRIXAS	CX21277924	SANTA TEREZINHA	09/12/2020 09:51	09/12/2020 11:35	09/12/2020 09:51	09/12/2020 11:35	1,73	1	1,73	CHI
20201247618	TAQUARAL DE GOIAS	TQ21148879	ITABERAI S1	09/12/2020 09:51	10/12/2020 10:38	09/12/2020 09:51	10/12/2020 10:38	24,77	1	24,77	CHI
20201252184	SAO MIGUEL DO ARAGUAIA	SM11100824	SAO MIGUEL DO ARAGUAIA	09/12/2020 09:51	09/12/2020 21:54	09/12/2020 09:51	09/12/2020 21:54	12,05	64	770,88	CHI
20201247628	BELA VISTA DE GOIAS	BV21325805	BELA VISTA S1	09/12/2020 09:52	09/12/2020 12:25	09/12/2020 09:52	09/12/2020 12:25	2,54	1	2,54	CHI
20201247638	APARECIDA DE GOIANIA	17034437	ATLANTICO S3	09/12/2020 09:53	09/12/2020 15:36	09/12/2020 09:53	09/12/2020 15:36	5,71	1	5,71	CHI
20201247649	JARAGUA	JA21121795	JARAGUA	09/12/2020 09:55	10/12/2020 11:12	09/12/2020 09:55	10/12/2020 11:12	25,27	2	50,55	CHI
20201247651	URUACU	UR21128497	URUACU	09/12/2020 09:55	09/12/2020 17:13	09/12/2020 09:55	09/12/2020 17:13	7,29	1	7,29	CHI
20201247658	GOIANIA	GN21001782	REAL S1	09/12/2020 09:56	09/12/2020 11:16	09/12/2020 10:45	09/12/2020 11:16	0,52	1	0,52	CHI
20201247661	NOVO GAMA	10014982623	PACAEMBU S1	09/12/2020 09:56	09/12/2020 12:46	09/12/2020 09:56	09/12/2020 12:46	2,82	1	2,82	CHI
20201247672	SANTA CRUZ DE GOIAS	BC12012519	PIRES DO RIO S2	09/12/2020 09:57	10/12/2020 11:36	09/12/2020 09:57	10/12/2020 11:36	25,64	2	51,27	CHI
20201247677	GOIAS	GS11162299	GOIAS	09/12/2020 09:58	09/12/2020 16:35	09/12/2020 09:58	09/12/2020 16:35	6,61	2	13,22	CHI
20201247680	PIRENOPOLIS	PV21227818	CORUMBA	09/12/2020 09:58	09/12/2020 18:57	09/12/2020 09:58	09/12/2020 18:57	8,97	1	8,97	CHI
20201247682	PONTALINA	PK21113180	PONTALINA	09/12/2020 09:58	09/12/2020 12:45	09/12/2020 09:58	09/12/2020 12:45	2,77	1	2,77	CHI
20201247691	JUSSARA	JR21019315	JUSSARA	09/12/2020 10:00	09/12/2020 11:33	09/12/2020 10:00	09/12/2020 11:33	1,55	1	1,55	CHI
20201247693	JARAGUA	JA21203552	JARAGUA	09/12/2020 10:00	09/12/2020 21:11	09/12/2020 10:00	09/12/2020 21:11	11,17	1	11,17	CHI

20201247704	SANTA TEREZA DE GOIAS	TB12170075	PORANGATU	09/12/2020 10:01	09/12/2020 14:55	09/12/2020 10:01	09/12/2020 14:55	4,90	3	14,69	CHI
20201247709	SAO MIGUEL DO ARAGUAIA	SM21027855	SAO MIGUEL DO ARAGUAIA	09/12/2020 10:01	10/12/2020 02:16	09/12/2020 10:01	10/12/2020 02:16	16,24	1	16,24	CHI
20201247711	RIO VERDE	630215005	CABRIUVA S2	09/12/2020 10:01	10/12/2020 08:49	09/12/2020 10:01	10/12/2020 08:49	22,79	1	22,79	CHI
20201247715	SANCLERLANDIA	SC21259228	FIRMINOPOLIS S2	09/12/2020 10:02	09/12/2020 16:23	09/12/2020 10:02	09/12/2020 16:23	6,34	1	6,34	CHI
20201247717	POSSE	PS21318305	IACIARA S2	09/12/2020 10:02	09/12/2020 15:09	09/12/2020 10:02	09/12/2020 15:09	5,11	1	5,11	CHI
20201248673	PIRENOPOLIS	PV12061976	SAO FRANCISCO DE GOIAS	09/12/2020 10:02	09/12/2020 19:50	09/12/2020 10:02	09/12/2020 19:50	9,80	8	78,40	CHI
20201247737	GOIANESIA	GE21354273	GOIANESIA S1	09/12/2020 10:03	09/12/2020 16:48	09/12/2020 10:03	09/12/2020 16:48	6,74	1	6,74	CHI
20201247743	ITABERAI	IB12108138	ITABERAI S2	09/12/2020 10:04	09/12/2020 12:10	09/12/2020 10:04	09/12/2020 12:10	2,10	25	52,47	CHI
20201247744	MARA ROSA	MQ12279137	MARA ROSA	09/12/2020 10:04	10/12/2020 09:49	09/12/2020 10:04	10/12/2020 09:49	23,74	2	47,49	CHI
20201247751	ACREUNA	EU21301045	ACREUNA	09/12/2020 10:04	09/12/2020 18:11	09/12/2020 10:04	09/12/2020 18:11	8,11	1	8,11	CHI
20201247758	FAINA	3600000601	ITAPURANGA	09/12/2020 10:05	09/12/2020 16:37	09/12/2020 10:05	09/12/2020 16:37	6,53	1	6,53	CHI
20201250271	SANTA RITA DO NOVO DESTINO	DF12382411	BARRO ALTO	09/12/2020 10:05	09/12/2020 23:57	09/12/2020 10:05	09/12/2020 23:57	13,86	8	110,86	CHI
20201247786	ARAGUAPAZ	AZ12274481	GOIAS	09/12/2020 10:07	09/12/2020 14:48	09/12/2020 10:07	09/12/2020 14:48	4,67	1	4,67	CHI
20201247858	CRISTALINA	KR12025841	PAMPLONA	09/12/2020 10:07	09/12/2020 13:50	09/12/2020 10:07	09/12/2020 13:50	3,71	3	11,14	CHI
20201248406	GOIATUBA	GT12044924	GOIATUBA S2	09/12/2020 10:07	10/12/2020 11:59	09/12/2020 10:07	10/12/2020 11:59	25,86	3	77,58	CHI
20201248406	MORRINHOS	GT12044924	GOIATUBA S2	09/12/2020 10:07	10/12/2020 11:59	09/12/2020 10:07	10/12/2020 11:59	25,86	3	77,58	CHI
20201251941	PIRENOPOLIS	PV12302141	SAO FRANCISCO DE GOIAS	09/12/2020 10:07	09/12/2020 22:31	09/12/2020 10:07	09/12/2020 22:31	12,39	95	1177,34	CHI
20201247795	NOVA CRIXAS	NA21158812	MOZARLANDIA	09/12/2020 10:08	09/12/2020 12:40	09/12/2020 10:08	09/12/2020 12:40	2,53	1	2,53	CHI
20201247801	VIANOPOLIS	VN12194266	VIANOPOLIS	09/12/2020 10:08	09/12/2020 19:49	09/12/2020 10:08	09/12/2020 19:49	9,67	5	48,35	CHI
20201247802	SAO MIGUEL DO ARAGUAIA	SM21138133	SAO MIGUEL DO ARAGUAIA	09/12/2020 10:08	10/12/2020 09:23	09/12/2020 10:08	10/12/2020 09:23	23,23	1	23,23	CHI
20201247804	IPORA	IR12374908	IPORA	09/12/2020 10:09	09/12/2020 10:50	09/12/2020 10:09	09/12/2020 10:50	0,68	10	6,81	CHI
20201247810	INDIARA	IY21361616	EDEIA	09/12/2020 10:10	09/12/2020 18:40	09/12/2020 10:10	09/12/2020 18:40	8,50	1	8,50	CHI
20201249418	EDEALINA	ED12223290	PONTALINA	09/12/2020 10:10	09/12/2020 16:57	09/12/2020 10:10	09/12/2020 16:57	6,77	4	27,07	CHI
20201247842	APARECIDA DE GOIANIA	10018450847	INDEPENDENCIA S1	09/12/2020 10:11	09/12/2020 12:18	09/12/2020 10:11	09/12/2020 12:18	2,11	1	2,11	CHI
20201247872	LUZIANIA	LZ21266471	MARAJOARA	09/12/2020 10:14	09/12/2020 12:20	09/12/2020 10:14	09/12/2020 12:20	2,09	1	2,09	CHI
20201247881	ANICUNS	AC21323779	ANICUNS	09/12/2020 10:16	09/12/2020 17:02	09/12/2020 10:16	09/12/2020 17:02	6,76	1	6,76	CHI
20201247882	CAMPOS BELOS	820005733	SAO DOMINGOS	09/12/2020 10:16	09/12/2020 13:00	09/12/2020 10:16	09/12/2020 13:00	2,73	1	2,73	CHI
20201247883	NIQUELANDIA	2750062178	NIQUELANDIA SUBTRANSMISSAO	09/12/2020 10:16	09/12/2020 14:31	09/12/2020 10:16	09/12/2020 14:31	4,24	1	4,24	CHI
20201247888	BONFINOPOLIS	920008100	CEPAIGO S2	09/12/2020 10:16	09/12/2020 12:27	09/12/2020 10:16	09/12/2020 12:27	2,17	1	2,17	CHI
20201248501	JATAI	JT12248490	JATAI S1	09/12/2020 10:16	09/12/2020 13:47	09/12/2020 10:16	09/12/2020 13:47	3,50	6	21,00	CHI
20201247898	APARECIDA DE GOIANIA	17359016	INDEPENDENCIA S2	09/12/2020 10:17	09/12/2020 12:19	09/12/2020 10:17	09/12/2020 12:19	2,02	1	2,02	CHI
20201252084	JATAI	7421584	CACHOEIRA ALTA	09/12/2020 10:17	10/12/2020 17:00	09/12/2020 10:17	10/12/2020 17:00	30,70	1	30,70	CHI
20201252084	RIO VERDE	7421584	CACHOEIRA ALTA	09/12/2020 10:17	10/12/2020 17:00	09/12/2020 10:17	10/12/2020 17:00	30,70	5	153,51	CHI
20201247901	BURITI ALEGRE	420020986	ALTO BURITI	09/12/2020 10:18	10/12/2020 22:28	09/12/2020 10:18	10/12/2020 22:28	36,16	1	36,16	CHI
20201247909	ORIZONA	OZ21250427	PIRES DO RIO S2	09/12/2020 10:19	10/12/2020 09:13	09/12/2020 10:19	10/12/2020 09:13	22,89	1	22,89	CHI
20201247929	GOIAS	GS21364825	ITABERAI S1	09/12/2020 10:20	09/12/2020 17:27	09/12/2020 10:20	09/12/2020 17:27	7,12	2	14,23	CHI
20201247933	PIRACANJUBA	240054738	BELA VISTA S1	09/12/2020 10:21	09/12/2020 23:33	09/12/2020 10:21	09/12/2020 23:33	13,20	1	13,20	CHI
20201247935	SAO LUIS DE MONTES BELOS	SL21145985	FIRMINOPOLIS S2	09/12/2020 10:21	09/12/2020 11:55	09/12/2020 10:21	09/12/2020 11:55	1,56	1	1,56	CHI
20201247936	CACHOEIRA ALTA	CA21163366	CACHOEIRA ALTA	09/12/2020 10:21	09/12/2020 16:24	09/12/2020 10:21	09/12/2020 16:24	6,04	1	6,04	CHI
20201247946	GOIANIA	GN21000727	AEROPORTO S1	09/12/2020 10:22	09/12/2020 16:30	09/12/2020 11:00	09/12/2020 16:30	5,51	24	132,24	CHI
20201247947	FAZENDA NOVA	FN12250532	JUSSARA	09/12/2020 10:22	09/12/2020 11:45	09/12/2020 10:22	09/12/2020 11:45	1,37	10	13,67	CHI
20201249933	CAMPINACU	UC12239713	PORANGATU	09/12/2020 10:22	09/12/2020 19:49	09/12/2020 10:22	09/12/2020 19:49	9,44	4	37,75	CHI
20201247994	CACHOEIRA ALTA	CA21296665	CACHOEIRA ALTA	09/12/2020 10:23	09/12/2020 14:50	09/12/2020 10:23	09/12/2020 14:50	4,44	3	13,31	CHI
20201247949	PALMEIRAS DE GOIAS	PL21063004	TRINDADE	09/12/2020 10:24	09/12/2020 16:06	09/12/2020 10:24	09/12/2020 16:06	5,70	1	5,70	CHI
20201247961	GOIANIA	GN12001115	CAMPINAS S3	09/12/2020 10:25	09/12/2020 14:08	09/12/2020 10:25	09/12/2020 13:54	3,48	113	393,24	CHI
20201247961	GOIANIA	GN12001115	CAMPINAS S3	09/12/2020 10:25	09/12/2020 14:08	09/12/2020 14:04	09/12/2020 14:08	0,08	113	8,63	CHI
20201247971	PALMEIRAS DE GOIAS	PL21000225	PALMEIRAS	09/12/2020 10:26	09/12/2020 17:23	09/12/2020 10:26	09/12/2020 17:23	6,94	1	6,94	CHI
20201249142	MORRINHOS	MR12394199	MORRINHOS	09/12/2020 10:26	10/12/2020 09:13	09/12/2020 10:26	10/12/2020 09:13	22,78	6	136,68	CHI
20201247972	TRINDADE	11894441	GOYA S1	09/12/2020 10:27	10/12/2020 03:27	09/12/2020 10:27	10/12/2020 03:27	17,00	1	17,00	CHI
20201247974	SAO MIGUEL DO ARAGUAIA	SM21334307	SAO MIGUEL DO ARAGUAIA	09/12/2020 10:27	09/12/2020 15:16	09/12/2020 10:27	09/12/2020 15:16	4,81	1	4,81	CHI
20201247980	ITAGUARI	10022434257	ITABERAI S1	09/12/2020 10:28	10/12/2020 07:13	09/12/2020 10:28	10/12/2020 07:13	20,74	1	20,74	CHI

20201247984	GOIANIA	10565620	REAL S2	09/12/2020 10:28	09/12/2020 13:34	09/12/2020 10:28	09/12/2020 13:34	3,09	1	3,09	CHI
20201249039	PIRACANJUBA	PJ12223317	PIRACANJUBA	09/12/2020 10:28	10/12/2020 09:56	09/12/2020 10:28	10/12/2020 09:56	23,46	8	187,68	CHI
20201249496	CAIAPONIA	CP12265311	MONTIVIDIU T	09/12/2020 10:28	09/12/2020 20:13	09/12/2020 10:28	09/12/2020 20:13	9,75	13	126,69	CHI
20201247988	GOIANIA	14903660	GOIANIA LESTE S3	09/12/2020 10:29	09/12/2020 14:36	09/12/2020 10:29	09/12/2020 14:36	4,11	1	4,11	CHI
20201247990	FORMOSA	FA12085562	ITUIQUIRA	09/12/2020 10:29	10/12/2020 08:28	09/12/2020 10:29	10/12/2020 08:28	21,98	4	87,90	CHI
20201247992	SAO FRANCISCO DE GOIAS	SF21021091	SAO FRANCISCO DE GOIAS	09/12/2020 10:29	09/12/2020 13:43	09/12/2020 10:29	09/12/2020 13:43	3,22	2	6,44	CHI
20201247993	MINACU	IH12396688	MINACU	09/12/2020 10:29	09/12/2020 17:13	09/12/2020 10:29	09/12/2020 17:13	6,72	33	221,79	CHI
20201247997	FAINA	FC21220439	GOIAS	09/12/2020 10:30	09/12/2020 18:10	09/12/2020 10:30	09/12/2020 18:10	7,65	1	7,65	CHI
20201248401	SAO LUIS DE MONTES BELOS	SL11000047	SAO LUIZ DOS MONTES BELOS	09/12/2020 10:30	09/12/2020 18:27	09/12/2020 10:30	09/12/2020 18:27	7,94	140	1111,25	CHI
20201247762	FAZENDA NOVA	FN12113974	IPORA	09/12/2020 10:31	09/12/2020 22:32	09/12/2020 10:31	09/12/2020 22:32	12,00	17	204,01	CHI
20201247762	ISRAELANDIA	FN12113974	IPORA	09/12/2020 10:31	09/12/2020 22:32	09/12/2020 10:31	09/12/2020 22:32	12,00	11	132,01	CHI
20201248010	CACHOEIRA ALTA	CA21196159	CACHOEIRA ALTA	09/12/2020 10:31	09/12/2020 17:10	09/12/2020 10:31	09/12/2020 17:10	6,65	2	13,29	CHI
20201248023	ANAPOLIS	AN21001113	ANAPOLIS UNIVERSITARIO S2	09/12/2020 10:31	09/12/2020 13:19	09/12/2020 10:31	09/12/2020 13:19	2,79	1	2,79	CHI
20201248041	SANTO ANTONIO DO DESCOBERTO	SN11168731	AGUAS LINDAS DE GOIAS S2	09/12/2020 10:33	09/12/2020 14:38	09/12/2020 10:33	09/12/2020 14:38	4,08	44	179,35	CHI
20201248164	SANTO ANTONIO DO DESCOBERTO	SN12060289	ALEXANIA	09/12/2020 10:33	09/12/2020 13:41	09/12/2020 10:33	09/12/2020 13:41	3,12	5	15,60	CHI
20201250016	IPAMERI	UT12027140	URUTAI	09/12/2020 10:33	09/12/2020 21:49	09/12/2020 10:33	09/12/2020 21:49	11,27	14	157,71	CHI
20201250016	URUTAI	UT12027140	URUTAI	09/12/2020 10:33	09/12/2020 21:49	09/12/2020 10:33	09/12/2020 21:49	11,27	1	11,27	CHI
20201248060	PARANAIGUARA	PC21420048	QUIRINOPOLIS	09/12/2020 10:35	10/12/2020 07:58	09/12/2020 10:35	10/12/2020 07:58	21,38	1	21,38	CHI
20201248062	VICENTINOPOLIS	10030886960	VICENTINOPOLIS	09/12/2020 10:35	10/12/2020 07:22	09/12/2020 10:35	10/12/2020 07:22	20,77	1	20,77	CHI
20201248063	NIQUELANDIA	10011847024	URUACU	09/12/2020 10:35	09/12/2020 16:59	09/12/2020 10:35	09/12/2020 16:59	6,39	1	6,39	CHI
20201248067	ITABERAI	IB21311056	ITABERAI S2	09/12/2020 10:36	09/12/2020 11:23	09/12/2020 10:36	09/12/2020 11:23	0,78	2	1,56	CHI
20201248069	GOIANIA	10350068	CAMPINAS S1	09/12/2020 10:36	09/12/2020 13:27	09/12/2020 10:36	09/12/2020 13:27	2,84	1	2,84	CHI
20201248070	ANAPOLIS	10004848045	ANAPOLIS UNIVERSITARIO S2	09/12/2020 10:36	09/12/2020 15:35	09/12/2020 10:36	09/12/2020 15:35	4,97	1	4,97	CHI
20201248075	PORANGATU	840150660	PORANGATU	09/12/2020 10:38	09/12/2020 15:10	09/12/2020 10:38	09/12/2020 15:10	4,53	1	4,53	CHI
20201248077	SENADOR CANEDO	190050573	SENADOR CANEDO	09/12/2020 10:38	09/12/2020 13:47	09/12/2020 10:38	09/12/2020 13:47	3,14	1	3,14	CHI
20201248078	MONTES CLAROS DE GOIAS	ME21040233	IPORA	09/12/2020 10:38	09/12/2020 19:23	09/12/2020 10:38	09/12/2020 19:23	8,74	1	8,74	CHI
20201248082	NIQUELANDIA	NQ21317747	NIQUELANDIA SUBTRANSMISSAO	09/12/2020 10:38	09/12/2020 17:17	09/12/2020 10:38	09/12/2020 17:17	6,63	1	6,63	CHI
20201248087	JAUPACI	JP21021467	IPORA	09/12/2020 10:39	09/12/2020 11:51	09/12/2020 10:39	09/12/2020 11:51	1,19	1	1,19	CHI
20201248089	URUACU	UR12339041	URUACU	09/12/2020 10:39	09/12/2020 16:50	09/12/2020 10:39	09/12/2020 16:50	6,17	36	222,11	CHI
20201249445	MUNDO NOVO DE GOIAS	MH12274850	NOVA CRIXAS	09/12/2020 10:39	09/12/2020 23:05	09/12/2020 10:39	09/12/2020 23:05	12,42	7	86,93	CHI
20201248100	AURILANDIA	AI21000009	FIRMINOPOLIS S2	09/12/2020 10:41	10/12/2020 05:40	09/12/2020 10:41	10/12/2020 05:40	18,97	2	37,94	CHI
20201249398	CATALAO	CT12195398RE	CATALAO S1	09/12/2020 10:41	09/12/2020 21:26	09/12/2020 10:41	09/12/2020 21:26	10,75	107	1150,13	CHI
20201248103	PANAMA	PX12057616	GOIATUBA S1	09/12/2020 10:42	10/12/2020 09:57	09/12/2020 10:42	10/12/2020 09:57	23,25	45	1046,04	CHI
20201248116	SAO MIGUEL DO ARAGUAIA	SM12193513	SAO MIGUEL DO ARAGUAIA	09/12/2020 10:43	09/12/2020 15:07	09/12/2020 10:43	09/12/2020 15:07	4,39	1	4,39	CHI
20201248179	PALMEIRAS DE GOIAS	PL12095608	PALMEIRAS	09/12/2020 10:44	09/12/2020 12:39	09/12/2020 10:44	09/12/2020 12:39	1,91	10	19,08	CHI
20201248137	MORRINHOS	MR21125561	GOIATUBA S2	09/12/2020 10:45	09/12/2020 18:07	09/12/2020 10:45	09/12/2020 18:07	7,35	2	14,71	CHI
20201248140	APARECIDA DE GOIANIA	10018080543	INDEPENDENCIA S2	09/12/2020 10:46	09/12/2020 12:03	09/12/2020 10:46	09/12/2020 12:03	1,28	1	1,28	CHI
20201248143	ARUANA	AK12187681	ARUANA	09/12/2020 10:46	10/12/2020 07:28	09/12/2020 10:46	10/12/2020 07:28	20,69	7	144,81	CHI
20201251077	ITAGUARU	IC12376461	ITABERAI S1	09/12/2020 10:46	11/12/2020 11:45	10/12/2020 13:33	11/12/2020 09:44	20,19	29	585,48	CHI
20201251077	HEITORAI	IC12376461	ITABERAI S1	09/12/2020 10:46	11/12/2020 11:45	10/12/2020 13:33	11/12/2020 09:44	20,19	1	20,19	CHI
20201251077	HEITORAI	IC12376461	ITABERAI S1	09/12/2020 10:46	11/12/2020 11:45	10/12/2020 13:33	11/12/2020 10:25	20,87	7	146,06	CHI
20201251077	ITAGUARU	IC12376461	ITABERAI S1	09/12/2020 10:46	11/12/2020 11:45	10/12/2020 13:33	11/12/2020 10:25	20,87	3	62,60	CHI
20201251077	ITAGUARU	IC12376461	ITABERAI S1	09/12/2020 10:46	11/12/2020 11:45	10/12/2020 13:33	11/12/2020 11:45	22,21	11	244,29	CHI
202012179368	ITAGUARU	IC21220432	ITABERAI S1	09/12/2020 10:46	11/12/2020 09:44	09/12/2020 10:46	11/12/2020 09:44	46,96	2	93,93	CHI
202012179368	ITAGUARU	IC21327371	ITABERAI S1	09/12/2020 10:46	11/12/2020 09:44	09/12/2020 17:57	11/12/2020 09:44	39,78	1	39,78	CHI
20201248153	ITAGUARU	IB11244011	ITABERAI S1	09/12/2020 10:47	10/12/2020 13:53	09/12/2020 10:47	10/12/2020 13:53	27,08	1	27,08	CHI
20201248622	CACHOEIRA DOURADA	CD12000044	CACHOEIRA DOURADA	09/12/2020 10:47	09/12/2020 14:41	09/12/2020 10:47	09/12/2020 14:41	3,90	10	38,97	CHI
20201248161	CRIXAS	CX21342319	SANTA TEREZINHA	09/12/2020 10:49	09/12/2020 15:09	09/12/2020 10:49	09/12/2020 15:09	4,33	1	4,33	CHI
20201248738	PIRACANJUBA	PJ12212153	PIRACANJUBA	09/12/2020 10:49	10/12/2020 10:20	09/12/2020 10:49	10/12/2020 10:20	23,50	6	141,01	CHI
20201248175	ITAPIRAPUA	IU12089737	MATRINCHA	09/12/2020 10:50	09/12/2020 15:23	09/12/2020 10:50	09/12/2020 15:23	4,54	6	27,21	CHI
20201248252	FORMOSA	FA12397036	ITUIQUIRA	09/12/2020 10:50	09/12/2020 21:08	09/12/2020 10:50	09/12/2020 21:08	10,28	3	30,85	CHI

20201248494	CATALAO	CT12266869	CATALAO S1	09/12/2020 10:50	09/12/2020 17:26	09/12/2020 10:50	09/12/2020 17:26	6,59	4	26,37	CHI
20201249578	JARAGUA	JA12374473	JARAGUA	09/12/2020 10:50	09/12/2020 16:36	09/12/2020 10:50	09/12/2020 16:36	5,76	37	213,23	CHI
20201248178	APARECIDA DE GOIANIA	10029440341	INDEPENDENCIA S1	09/12/2020 10:51	09/12/2020 12:45	09/12/2020 10:51	09/12/2020 12:45	1,90	1	1,90	CHI
20201248180	PORANGATU	PO21052525	PORANGATU	09/12/2020 10:51	09/12/2020 15:58	09/12/2020 10:51	09/12/2020 15:58	5,11	1	5,11	CHI
20201248182	PIRENOPOLIS	PV21287803	GOIANESIA S1	09/12/2020 10:51	09/12/2020 22:12	09/12/2020 10:51	09/12/2020 22:12	11,34	1	11,34	CHI
20201248183	PARAUNA	980037244	PARAUNA	09/12/2020 10:51	09/12/2020 16:48	09/12/2020 10:51	09/12/2020 16:48	5,94	1	5,94	CHI
20201248188	GOIANIA	13370893	CAMPINAS S3	09/12/2020 10:52	09/12/2020 16:35	09/12/2020 10:52	09/12/2020 16:35	5,70	1	5,70	CHI
20201248194	FORMOSA	FA12252013	SAO JOAO D ALIANCA	09/12/2020 10:53	09/12/2020 14:33	09/12/2020 10:53	09/12/2020 14:33	3,66	1	3,66	CHI
20201248198	ORIZONA	2060013131	PIRES DO RIO S2	09/12/2020 10:53	10/12/2020 08:10	09/12/2020 10:53	10/12/2020 08:10	21,27	1	21,27	CHI
20201249066	NOVA CRIXAS	CX12145544	RUBIATABA	09/12/2020 10:53	09/12/2020 23:12	09/12/2020 10:53	09/12/2020 23:12	12,32	1	12,32	CHI
20201249066	CRIXAS	CX12145544	RUBIATABA	09/12/2020 10:53	09/12/2020 23:12	09/12/2020 10:53	09/12/2020 23:12	12,32	102	1256,30	CHI
20201248202	BURITI ALEGRE	GT21161946	GOIATUBA S2	09/12/2020 10:54	10/12/2020 04:29	09/12/2020 10:54	10/12/2020 04:29	17,58	1	17,58	CHI
20201248211	CRISTALINA	KR21270424	CRISTALINA S2	09/12/2020 10:56	10/12/2020 02:23	09/12/2020 10:56	10/12/2020 02:23	15,45	1	15,45	CHI
20201248212	PALMELO	PZ11216193	PIRES DO RIO S2	09/12/2020 10:56	10/12/2020 00:15	09/12/2020 10:56	10/12/2020 00:15	13,31	50	665,74	CHI
20201248214	RIO VERDE	10011947002	RIO VERDE S2	09/12/2020 10:56	09/12/2020 18:40	09/12/2020 10:56	09/12/2020 18:40	7,73	0	0,00	CHI
20201248220	HIDROLANDIA	180057352	ANHANGUERA	09/12/2020 10:57	09/12/2020 13:42	09/12/2020 10:57	09/12/2020 13:42	2,75	1	2,75	CHI
20201248224	PIRENOPOLIS	PV21082497	RANGUMBA	09/12/2020 10:57	10/12/2020 00:50	09/12/2020 10:57	10/12/2020 00:50	13,87	2	27,74	CHI
20201248254	GOIANIA	GN11001666	REAL S1	09/12/2020 10:59	09/12/2020 13:39	09/12/2020 10:59	09/12/2020 13:39	2,65	111	294,46	CHI
20201248239	GOIANIA	16286182	SENADOR CANEDO	09/12/2020 11:00	09/12/2020 15:05	09/12/2020 11:00	09/12/2020 15:05	4,08	1	4,08	CHI
20201248241	ITAPACI	IW12275237	ITAPACI	09/12/2020 11:00	09/12/2020 15:58	09/12/2020 11:00	09/12/2020 15:58	4,96	3	14,89	CHI
20201248242	CALDAS NOVAS	10001809588	CALDAS NOVAS S1	09/12/2020 11:00	09/12/2020 21:14	09/12/2020 11:00	09/12/2020 21:14	10,22	1	10,22	CHI
20201248519	JARAGUA	JA12064317	JARAGUA	09/12/2020 11:00	10/12/2020 09:13	09/12/2020 11:00	10/12/2020 09:13	22,21	49	1088,07	CHI
20201248262	URUTAI	UT21337246	URUTAI	09/12/2020 11:03	09/12/2020 23:14	09/12/2020 11:03	09/12/2020 23:14	12,17	1	12,17	CHI
20201248777	SANTA TEREZINHA DE GOIAS	SG12181455	SANTA TEREZINHA	09/12/2020 11:03	09/12/2020 16:49	09/12/2020 11:03	09/12/2020 16:49	5,75	19	109,30	CHI
20201248268	SENADOR CANEDO	15795263	SENADOR CANEDO	09/12/2020 11:04	09/12/2020 16:40	09/12/2020 11:04	09/12/2020 16:40	5,59	1	5,59	CHI
20201248269	IPAMERI	IP12015150	IPAMERI	09/12/2020 11:04	09/12/2020 13:34	09/12/2020 11:04	09/12/2020 13:34	2,48	6	14,90	CHI
20201248272	PARAUNA	PU21259245	PARAUNA	09/12/2020 11:05	09/12/2020 15:44	09/12/2020 11:05	09/12/2020 15:44	4,64	1	4,64	CHI
20201249364	ANAPOLIS	AN11198726	ANAPOLIS UNIVERSITARIO S2	09/12/2020 11:05	09/12/2020 18:02	09/12/2020 11:05	09/12/2020 18:02	6,94	139	964,04	CHI
20201248275	ISRAELANDIA	10001919588	IPORA	09/12/2020 11:06	09/12/2020 12:26	09/12/2020 11:06	09/12/2020 12:26	1,33	1	1,33	CHI
20201248318	GOIANIA	GN11203354	GOYA S2	09/12/2020 11:06	09/12/2020 15:45	09/12/2020 11:06	09/12/2020 15:45	4,65	246	1143,90	CHI
20201248284	SAO MIGUEL DO PASSA QUATRO	10009871762	CRISTIANOPOLIS	09/12/2020 11:07	09/12/2020 15:32	09/12/2020 11:07	09/12/2020 15:32	4,41	1	4,41	CHI
20201248289	GOIAS	90016609	GOIAS	09/12/2020 11:07	09/12/2020 15:11	09/12/2020 11:07	09/12/2020 15:11	4,05	1	4,05	CHI
20201248341	APARECIDA DE GOIANIA	AP11093008	REAL S2	09/12/2020 11:08	09/12/2020 15:50	09/12/2020 11:08	09/12/2020 15:50	4,70	78	366,49	CHI
20201248302	QUIRINOPOLIS	10009984230	QUIRINOPOLIS	09/12/2020 11:09	09/12/2020 14:58	09/12/2020 11:09	09/12/2020 14:58	3,80	1	3,80	CHI
20201248821	APARECIDA DE GOIANIA	AP11166600	REAL S2	09/12/2020 11:09	09/12/2020 14:47	09/12/2020 11:09	09/12/2020 14:47	3,63	58	210,35	CHI
20201248184	RIO QUENTE	RQ21063415	RIO QUENTE	09/12/2020 11:10	10/12/2020 22:36	09/12/2020 11:10	10/12/2020 22:02	34,85	1	34,85	CHI
20201248184	RIO QUENTE	RQ12182980LD	RIO QUENTE	09/12/2020 11:10	10/12/2020 22:36	09/12/2020 11:10	10/12/2020 22:36	35,43	6	212,59	CHI
20201248184	MORRINHOS	RQ12182980LD	RIO QUENTE	09/12/2020 11:10	10/12/2020 22:36	09/12/2020 11:10	10/12/2020 22:36	35,43	10	354,32	CHI
20201248184	RIO QUENTE	RQ12182980LD	RIO QUENTE	09/12/2020 11:10	10/12/2020 22:36	10/12/2020 20:38	10/12/2020 22:36	1,96	30	58,91	CHI
20201248184	MORRINHOS	RQ12182980LD	RIO QUENTE	09/12/2020 11:10	10/12/2020 22:36	10/12/2020 20:38	10/12/2020 22:36	1,96	41	80,51	CHI
20201248184	CALDAS NOVAS	RQ12182980LD	RIO QUENTE	09/12/2020 11:10	10/12/2020 22:36	10/12/2020 20:38	10/12/2020 22:36	1,96	1	1,96	CHI
20201248534	NOVA IGUACU DE GOIAS	NH12317131	CAMPINORTE	09/12/2020 11:10	09/12/2020 15:49	09/12/2020 11:10	09/12/2020 15:49	4,64	46	213,24	CHI
20201248316	GOIANIA	12354120	AEROPORTO S1	09/12/2020 11:11	09/12/2020 13:20	09/12/2020 11:11	09/12/2020 13:20	2,15	1	2,15	CHI
20201248321	CAMPOS VERDES	VD11055151	SANTA TEREZINHA	09/12/2020 11:11	09/12/2020 15:46	09/12/2020 11:11	09/12/2020 15:46	4,58	5	22,88	CHI
20201248376	CALDAS NOVAS	CN11000034	CALDAS NOVAS S2	09/12/2020 11:11	09/12/2020 12:23	09/12/2020 11:11	09/12/2020 12:23	1,19	34	40,37	CHI
20201248324	PALMINOPOLIS	PL2126729	PALMEIRAS	09/12/2020 11:12	09/12/2020 21:12	09/12/2020 11:12	09/12/2020 21:12	10,00	1	10,00	CHI
20201248327	PADRE BERNARDO	2760019026	PADRE BERNARDO	09/12/2020 11:12	09/12/2020 12:31	09/12/2020 11:12	09/12/2020 12:31	1,32	1	1,32	CHI
20201248329	ITAPACI	IW21238560	RUBIATABA	09/12/2020 11:12	09/12/2020 16:05	09/12/2020 11:12	09/12/2020 16:05	4,87	1	4,87	CHI
20201248333	LUZIANIA	LZ11136643	RIO VERMELHO	09/12/2020 11:12	09/12/2020 14:35	09/12/2020 11:12	09/12/2020 14:35	3,37	134	451,58	CHI
20201248350	CRIXAS	CX12283275	SERRA DO OURO	09/12/2020 11:14	09/12/2020 14:37	09/12/2020 11:14	09/12/2020 14:37	3,37	2	6,73	CHI
20201251203	FORMOSA	FA12204759	ITUIQUIRA	09/12/2020 11:14	09/12/2020 21:25	09/12/2020 11:14	09/12/2020 21:25	10,17	262	2665,41	CHI

20201251203	VILA BOA	FA12204759	ITUIQUIRA	09/12/2020 11:14	09/12/2020 21:25	09/12/2020 11:14	09/12/2020 21:25	10,17	2	20,35	CHI
20201248351	MONTES CLAROS DE GOIAS	ME21066066	ARENOPOLIS	09/12/2020 11:15	09/12/2020 14:19	09/12/2020 11:15	09/12/2020 14:19	3,07	1	3,07	CHI
20201248353	GOIANIA	12107864	GOYA S1	09/12/2020 11:15	09/12/2020 12:45	09/12/2020 11:15	09/12/2020 12:45	1,49	1	1,49	CHI
20201248462	NIQUELANDIA	NQ12262808	BARRO ALTO	09/12/2020 11:15	12/12/2020 23:36	09/12/2020 11:15	10/12/2020 10:04	22,82	18	410,70	CHI
20201248462	NIQUELANDIA	NQ12262808	BARRO ALTO	09/12/2020 11:15	12/12/2020 23:36	10/12/2020 10:29	10/12/2020 13:45	3,25	6	19,53	CHI
20201248462	NIQUELANDIA	NQ12257447	BARRO ALTO	09/12/2020 11:15	12/12/2020 23:36	09/12/2020 11:15	10/12/2020 19:58	32,71	5	163,57	CHI
20201248462	NIQUELANDIA	NQ12294573	BARRO ALTO	09/12/2020 11:15	12/12/2020 23:36	10/12/2020 10:29	10/12/2020 20:46	10,27	3	30,81	CHI
20201248462	NIQUELANDIA	NQ12264564	BARRO ALTO	09/12/2020 11:15	12/12/2020 23:36	10/12/2020 10:29	12/12/2020 23:36	61,11	10	611,06	CHI
20201248357	JARAGUA	JA21227851	JARAGUA	09/12/2020 11:16	09/12/2020 16:56	09/12/2020 11:16	09/12/2020 16:56	5,67	2	11,33	CHI
20201248359	CIDADE OCIDENTAL	DH21152861	MARAJOARA	09/12/2020 11:16	09/12/2020 15:21	09/12/2020 11:16	09/12/2020 15:21	4,07	1	4,07	CHI
20201248536	PIRENOPOLIS	PV12171328	CORUMBA	09/12/2020 11:16	10/12/2020 11:15	09/12/2020 11:16	10/12/2020 11:15	23,97	3	71,90	CHI
20201248367	AGUA FRIA DE GOIAS	TL11279972	SAO JOAO D ALIANCA	09/12/2020 11:17	09/12/2020 13:12	09/12/2020 11:17	09/12/2020 13:12	1,91	3	5,73	CHI
20201248368	APARECIDA DE GOIANIA	15187019	REAL S2	09/12/2020 11:17	09/12/2020 13:38	09/12/2020 11:17	09/12/2020 13:38	2,34	1	2,34	CHI
20201248396	RIO QUENTE	RQ21000045	RIO QUENTE	09/12/2020 11:19	09/12/2020 14:40	09/12/2020 11:19	09/12/2020 14:40	3,35	2	6,70	CHI
20201248398	GOIANIA	11029018	FERROVIARIO S3	09/12/2020 11:19	09/12/2020 16:35	09/12/2020 11:19	09/12/2020 16:35	5,25	1	5,25	CHI
20201248404	UIRAPURU	UP12392059	SANTA TEREZINHA	09/12/2020 11:20	09/12/2020 14:31	09/12/2020 11:20	09/12/2020 14:31	3,18	3	9,54	CHI
20201248408	COLINAS DO SUL	TI21355521	NIQUELANDIA SUBTRANSMISSAO	09/12/2020 11:20	09/12/2020 23:04	09/12/2020 11:20	09/12/2020 23:04	11,72	1	11,72	CHI
20201248410	JARAGUA	JA21114646	JARAGUA	09/12/2020 11:20	10/12/2020 01:34	09/12/2020 11:20	10/12/2020 01:34	14,22	2	28,44	CHI
20201248411	SANTO ANTONIO DO DESCOBERTO	SN21265749	AGUAS LINDAS DE GOIAS S2	09/12/2020 11:21	09/12/2020 18:42	09/12/2020 11:21	09/12/2020 18:42	7,34	1	7,34	CHI
20201248412	CRIXAS	CX12276750	SERRA DO OURO	09/12/2020 11:21	09/12/2020 16:59	09/12/2020 11:21	09/12/2020 16:59	5,62	9	50,59	CHI
20201250482	JARAGUA	JA12388822LD	JARAGUA	09/12/2020 11:21	10/12/2020 03:53	09/12/2020 11:21	10/12/2020 03:53	16,53	369	6099,06	CHI
20201250482	PIRENOPOLIS	JA12388822LD	JARAGUA	09/12/2020 11:21	10/12/2020 03:53	09/12/2020 11:21	10/12/2020 03:53	16,53	55	909,07	CHI
20201248415	GOIANIRA	GR11202927	GOIANIRA	09/12/2020 11:22	09/12/2020 19:20	09/12/2020 11:22	09/12/2020 19:20	7,96	14	111,39	CHI
20201248421	CAMPESTRE DE GOIAS	GC21005196	TRINDADE	09/12/2020 11:23	09/12/2020 14:08	09/12/2020 11:23	09/12/2020 14:08	2,74	2	5,48	CHI
20201248422	GOIANIA	GN21391324	GOYA S1	09/12/2020 11:23	09/12/2020 15:50	09/12/2020 11:23	09/12/2020 15:50	4,44	1	4,44	CHI
20201248424	JAUPACI	JP21062810	IPORA	09/12/2020 11:24	09/12/2020 12:44	09/12/2020 11:24	09/12/2020 12:44	1,33	2	2,66	CHI
20201248720	GUARAITA	GK12274378	ITAPURANGA	09/12/2020 11:26	09/12/2020 14:59	09/12/2020 11:26	09/12/2020 14:59	3,54	14	49,52	CHI
20201248444	HIDROLINA	1020000457	URUACU	09/12/2020 11:27	09/12/2020 17:21	09/12/2020 11:27	09/12/2020 17:21	5,89	1	5,89	CHI
20201248471	PALMEIRAS DE GOIAS	PL12276819	PALMEIRAS	09/12/2020 11:27	09/12/2020 16:50	09/12/2020 11:27	09/12/2020 16:50	5,38	14	75,28	CHI
20201248448	PALMINOPOLIS	PP12053926	PALMEIRAS	09/12/2020 11:28	09/12/2020 22:40	09/12/2020 11:28	09/12/2020 22:40	11,20	2	22,41	CHI
20201248455	BURITI ALEGRE	420007994	ALTO BURITI	09/12/2020 11:28	09/12/2020 13:53	09/12/2020 11:28	09/12/2020 13:53	2,41	1	2,41	CHI
20201248456	FLORES DE GOIAS	FB12277844	IACIARA S2	09/12/2020 11:28	09/12/2020 11:56	09/12/2020 11:28	09/12/2020 11:56	0,46	2	0,91	CHI
20201248456	SITIO D ABADIA	FB12277844	IACIARA S2	09/12/2020 11:28	09/12/2020 11:56	09/12/2020 11:28	09/12/2020 11:56	0,46	5	2,29	CHI
20201248457	CORUMBAIBA	CI21190394	VILA CORUMBA	09/12/2020 11:28	09/12/2020 21:53	09/12/2020 11:28	09/12/2020 21:53	10,40	1	10,40	CHI
20201248458	ANAPOLIS	20218357	JUNDIAI S2	09/12/2020 11:28	10/12/2020 03:08	09/12/2020 11:28	10/12/2020 03:08	15,65	1	15,65	CHI
20201248461	CRISTALINA	1060000031	CRISTALINA S1	09/12/2020 11:29	09/12/2020 17:45	09/12/2020 11:29	09/12/2020 17:45	6,26	1	6,26	CHI
20201248805	GOIANIA	GN12405628	AEROPORTO S1	09/12/2020 11:29	09/12/2020 13:41	09/12/2020 11:29	09/12/2020 13:41	2,20	120	263,73	CHI
20201248469	APARECIDA DE GOIANIA	10002112939	ANHANGUERA	09/12/2020 11:30	09/12/2020 12:33	09/12/2020 11:30	09/12/2020 12:33	1,04	1	1,04	CHI
20201248470	DOVERLANDIA	DV21328616	CAIAPONIA	09/12/2020 11:30	09/12/2020 15:43	09/12/2020 11:30	09/12/2020 15:43	4,21	1	4,21	CHI
20201248472	JATAI	JT12213614	CACHOEIRA ALTA	09/12/2020 11:31	10/12/2020 09:11	09/12/2020 11:31	10/12/2020 09:11	21,66	1	21,66	CHI
20201248492	PARAUNA	PU21305888	ACREUNA	09/12/2020 11:32	09/12/2020 18:17	09/12/2020 11:32	09/12/2020 18:17	6,75	1	6,75	CHI
20201248500	APARECIDA DE GOIANIA	200224359	INDEPENDENCIA S2	09/12/2020 11:34	09/12/2020 14:46	09/12/2020 11:34	09/12/2020 14:46	3,19	1	3,19	CHI
20201248507	QUIRINOPOLIS	80123272	QUIRINOPOLIS	09/12/2020 11:35	09/12/2020 15:58	09/12/2020 11:35	09/12/2020 15:58	4,37	1	4,37	CHI
20201248508	LUZIANIA	LZ12031093	RIO VERMELHO	09/12/2020 11:35	09/12/2020 15:35	09/12/2020 11:35	09/12/2020 15:35	4,00	40	159,99	CHI
20201248512	SANTO ANTONIO DO DESCOBERTO	10017758724	ALEXANIA	09/12/2020 11:36	09/12/2020 13:05	09/12/2020 11:36	09/12/2020 13:05	1,47	1	1,47	CHI
20201248600	JATAI	JT12008872	JATAI S1	09/12/2020 11:37	09/12/2020 19:25	09/12/2020 11:37	09/12/2020 19:25	7,79	12	93,52	CHI
20201251667	FAINA	FC12272620	GOIAS	09/12/2020 11:37	09/12/2020 22:47	09/12/2020 11:37	09/12/2020 22:47	11,16	4	44,65	CHI
20201248526	SAO MIGUEL DO ARAGUAIA	SM11358655	SAO MIGUEL DO ARAGUAIA	09/12/2020 11:38	09/12/2020 22:30	09/12/2020 11:38	09/12/2020 22:30	10,85	1	10,85	CHI
20201251966	CRISTALINA	KR12219766	PAMPLONA	09/12/2020 11:38	10/12/2020 01:13	09/12/2020 11:38	10/12/2020 01:13	13,58	10	135,81	CHI
20201248529	SANTA HELENA DE GOIAS	SH31191813	IPEGUARI	09/12/2020 11:39	09/12/2020 16:11	09/12/2020 11:39	09/12/2020 16:11	4,53	1	4,53	CHI
20201248532	MINACU	IH12236254	MINACU	09/12/2020 11:39	11/12/2020 17:02	09/12/2020 11:39	11/12/2020 17:02	53,39	1	53,39	CHI

20201248979	JUSSARA	JR12011813	BRITANIA	09/12/2020 11:39	09/12/2020 22:30	09/12/2020 11:39	09/12/2020 22:30	10,84	28	303,66	CHI
20201248538	COCALZINHO DE GOIAS	1200024191	COCALZINHO	09/12/2020 11:40	09/12/2020 15:58	09/12/2020 11:40	09/12/2020 15:58	4,31	1	4,31	CHI
20201248540	CACHOEIRA ALTA	CA21084341	CACHOEIRA ALTA	09/12/2020 11:40	10/12/2020 10:23	09/12/2020 11:40	10/12/2020 10:23	22,71	1	22,71	CHI
20201248541	LUZIANIA	LZ21379006	MARAJOARA	09/12/2020 11:40	09/12/2020 12:02	09/12/2020 11:40	09/12/2020 12:02	0,36	1	0,36	CHI
20201248544	SANTA FE DE GOIAS	RN12206969	JUSSARA	09/12/2020 11:41	10/12/2020 00:19	09/12/2020 11:41	10/12/2020 00:19	12,63	3	37,89	CHI
20201249175	DIORAMA	DI12123918	ARENOPOLIS	09/12/2020 11:41	09/12/2020 16:25	09/12/2020 11:41	09/12/2020 16:25	4,72	5	23,58	CHI
20201249175	MONTES CLAROS DE GOIAS	DI12123918	ARENOPOLIS	09/12/2020 11:41	09/12/2020 16:25	09/12/2020 11:41	09/12/2020 16:25	4,72	1	4,72	CHI
20201248551	ITUMBIARA	690354794	ITUMBIARA VELHA S1	09/12/2020 11:42	10/12/2020 14:53	09/12/2020 11:42	10/12/2020 14:53	27,17	1	27,17	CHI
20201248554	JANDAIA	JD21100453	PALMEIRAS	09/12/2020 11:42	09/12/2020 18:15	09/12/2020 11:42	09/12/2020 18:15	6,54	2	13,08	CHI
20201249635	ITABERAI	IX12000065	INHUMAS S1	09/12/2020 11:42	10/12/2020 20:36	10/12/2020 14:44	10/12/2020 19:55	5,18	41	212,43	CHI
20201249635	ITAUCU	IX12000065	INHUMAS S1	09/12/2020 11:42	10/12/2020 20:36	10/12/2020 14:44	10/12/2020 19:55	5,18	39	202,06	CHI
20201249635	ITABERAI	IB12078567	ITABERAI S1	09/12/2020 11:42	10/12/2020 20:36	09/12/2020 11:42	10/12/2020 20:36	32,89	5	164,44	CHI
20201249635	ITAUCU	IB12078567	ITABERAI S1	09/12/2020 11:42	10/12/2020 20:36	09/12/2020 11:42	10/12/2020 20:36	32,89	1	32,89	CHI
20201249635	ITAUCU	IB12078567	ITABERAI S1	09/12/2020 11:42	10/12/2020 20:36	09/12/2020 15:55	10/12/2020 20:36	28,67	1	28,67	CHI
20201249635	ITABERAI	IB12078567	ITABERAI S1	09/12/2020 11:42	10/12/2020 20:36	09/12/2020 15:55	10/12/2020 20:36	28,67	12	344,07	CHI
20201248556	GOIANIA	GN11340280	CARAJAS S1	09/12/2020 11:43	09/12/2020 17:03	09/12/2020 11:43	09/12/2020 17:03	5,34	93	496,65	CHI
20201248557	AURILANDIA	AI31167241	SAO LUIZ DOS MONTES BELOS	09/12/2020 11:43	09/12/2020 19:15	09/12/2020 11:43	09/12/2020 19:15	7,54	1	7,54	CHI
20201250329	MOSSAMEDES	MD12161970	FIRMINOPOLIS S2	09/12/2020 11:43	09/12/2020 20:49	09/12/2020 11:43	09/12/2020 20:49	9,08	12	109,01	CHI
20201248563	CALDAS NOVAS	760005126	SERRA DE CALDAS	09/12/2020 11:44	09/12/2020 23:18	09/12/2020 11:44	09/12/2020 23:18	11,56	1	11,56	CHI
20201248566	CASTELANDIA	CL21384573	RIO DOS BOIS	09/12/2020 11:44	10/12/2020 10:35	09/12/2020 11:44	10/12/2020 10:35	22,84	1	22,84	CHI
20201248976	ITAPIRAPUA	IU12020125	MATRINCHA	09/12/2020 11:45	09/12/2020 17:28	09/12/2020 11:45	09/12/2020 17:28	5,70	14	79,82	CHI
20201248794	JUSSARA	JR12198907	BRITANIA	09/12/2020 11:46	09/12/2020 18:29	09/12/2020 11:46	09/12/2020 18:29	6,71	38	255,14	CHI
20201248585	FAINA	FC21310656	GOIAS	09/12/2020 11:47	09/12/2020 16:59	09/12/2020 11:47	09/12/2020 16:59	5,19	1	5,19	CHI
20201248824	TACUARAL DE GOIAS	TQ12250793	ITABERAI S1	09/12/2020 11:48	09/12/2020 15:53	09/12/2020 11:48	09/12/2020 15:53	4,08	11	44,91	CHI
20201248593	MORRINHOS	MR21279101	GOIATUBA S1	09/12/2020 11:49	09/12/2020 17:56	09/12/2020 11:49	09/12/2020 17:56	6,12	1	6,12	CHI
20201248595	GOIANIA	12296508	CARAJAS S2	09/12/2020 11:49	09/12/2020 15:39	09/12/2020 11:49	09/12/2020 15:39	3,83	1	3,83	CHI
20201248631	PIRES DO RIO	PR11202883	PIRES DO RIO S1	09/12/2020 11:50	09/12/2020 20:17	09/12/2020 11:50	09/12/2020 20:17	8,45	28	236,50	CHI
20201248612	SENADOR CANEDO	SW21106015	CEPAIGO S2	09/12/2020 11:51	09/12/2020 14:32	09/12/2020 11:51	09/12/2020 14:32	2,67	1	2,67	CHI
20201248613	MORRINHOS	MR21092109	MORRINHOS	09/12/2020 11:51	09/12/2020 14:04	09/12/2020 11:51	09/12/2020 14:04	2,21	2	4,41	CHI
20201248974	ANAPOLIS	AN12262491	ANAPOLIS UNIVERSITARIO S1	09/12/2020 11:51	09/12/2020 19:03	09/12/2020 11:51	09/12/2020 19:03	7,20	40	287,87	CHI
20201248626	ITABERAI	TQ12021964	ITABERAI S2	09/12/2020 11:53	09/12/2020 18:48	09/12/2020 11:53	09/12/2020 18:48	6,91	4	27,66	CHI
20201248630	CABECEIRAS	CW12243066	ITUIQUIRA	09/12/2020 11:53	09/12/2020 18:35	09/12/2020 11:53	09/12/2020 18:35	6,69	1	6,69	CHI
20201248668	PILAR DE GOIAS	GG12243730	SANTA TEREZINHA	09/12/2020 11:53	09/12/2020 17:45	09/12/2020 11:53	09/12/2020 17:45	5,87	28	164,27	CHI
20201248645	CALDAS NOVAS	CN11100160	SERRA DE CALDAS	09/12/2020 11:54	10/12/2020 10:17	09/12/2020 21:35	10/12/2020 10:17	12,70	60	761,78	CHI
20201248646	NOVO GAMA	2460168269	PACAEMBU S1	09/12/2020 11:54	09/12/2020 13:29	09/12/2020 11:54	09/12/2020 13:29	1,57	1	1,57	CHI
20201243876	PALMEIRAS DE GOIAS	PL12391508	PALMEIRAS	09/12/2020 11:55	09/12/2020 15:08	09/12/2020 11:55	09/12/2020 15:08	3,21	3	9,64	CHI
20201248652	CRISTALINA	KR21249951	CRISTALINA S2	09/12/2020 11:55	09/12/2020 15:52	09/12/2020 11:55	09/12/2020 15:52	3,94	1	3,94	CHI
20201249095	ANAPOLIS	AN12048812	ANAPOLIS UNIVERSITARIO S1	09/12/2020 11:55	09/12/2020 18:24	09/12/2020 11:55	09/12/2020 18:24	6,47	29	187,77	CHI
20201252207	CORREGO DO OURO	CO12320811	SAO LUIZ DOS MONTES BELOS	09/12/2020 11:55	10/12/2020 05:32	09/12/2020 11:55	10/12/2020 05:32	17,61	2	35,22	CHI
20201248658	SENADOR CANEDO	10007404920	SENADOR CANEDO	09/12/2020 11:56	09/12/2020 17:38	09/12/2020 11:56	09/12/2020 17:38	5,70	1	5,70	CHI
20201248661	ITAPURANGA	IK21299937	ITAPURANGA	09/12/2020 11:56	09/12/2020 14:45	09/12/2020 11:56	09/12/2020 14:45	2,81	1	2,81	CHI
20201248663	FORMOSA	FA12255318	ITUIQUIRA	09/12/2020 11:56	09/12/2020 15:38	09/12/2020 11:56	09/12/2020 15:38	3,69	2	7,37	CHI
20201249027	VILA PROPICIO	NP12327893LD	GOIANESIA S1	09/12/2020 11:56	09/12/2020 18:00	09/12/2020 11:56	09/12/2020 18:00	6,06	97	587,39	CHI
20201248666	SAO JOAO D ALIANCA	3840020680	ITUIQUIRA	09/12/2020 11:57	12/12/2020 09:50	09/12/2020 11:57	12/12/2020 09:50	69,89	1	69,89	CHI
20201249843	SANTA HELENA DE GOIAS	SH12023767	RIO DOS BOIS	09/12/2020 11:57	10/12/2020 10:06	09/12/2020 11:57	10/12/2020 10:06	22,14	2	44,27	CHI
20201248681	QUIRINOPOLIS	80080510	QUIRINOPOLIS	09/12/2020 11:58	09/12/2020 15:32	09/12/2020 11:58	09/12/2020 15:32	3,55	1	3,55	CHI
20201248978	ORIZONA	OZ12032532	PIRES DO RIO S2	09/12/2020 11:58	09/12/2020 22:06	09/12/2020 11:58	09/12/2020 22:06	10,13	7	70,93	CHI
20201248684	JATAI	290085410	JATAI S3	09/12/2020 11:59	10/12/2020 11:10	09/12/2020 11:59	10/12/2020 11:10	23,17	1	23,17	CHI
20201248685	ITAPURANGA	IK11379656	ITAPURANGA	09/12/2020 11:59	09/12/2020 15:44	09/12/2020 11:59	09/12/2020 15:44	3,74	2	7,47	CHI
20201248764	ANAPOLIS	AN11003269	JUNDIAI S1	09/12/2020 11:59	09/12/2020 15:34	09/12/2020 11:59	09/12/2020 15:34	3,58	145	518,86	CHI
20201248689	FAZENDA NOVA	FN21169385	JUSSARA	09/12/2020 12:00	09/12/2020 15:34	09/12/2020 12:00	09/12/2020 15:34	3,56	1	3,56	CHI

20201248694	PLANALTINA	PI12324322	SAO JOAO D ALIANCA	09/12/2020 12:00	09/12/2020 15:39	09/12/2020 12:00	09/12/2020 15:39	3,64	7	25,49	CHI
20201248700	CACU	CC21337042	CACHOEIRA ALTA	09/12/2020 12:02	10/12/2020 11:54	09/12/2020 12:02	10/12/2020 11:54	23,86	1	23,86	CHI
20201248705	URUACU	UR11236160	URUACU	09/12/2020 12:02	09/12/2020 16:58	09/12/2020 12:02	09/12/2020 16:58	4,92	25	122,99	CHI
20201248706	AMARALINA	LC12252699	MARA ROSA	09/12/2020 12:02	09/12/2020 15:44	09/12/2020 12:02	09/12/2020 15:44	3,69	8	29,48	CHI
202012179360	FAZENDA NOVA	FN21183355	BRITANIA	09/12/2020 12:03	10/12/2020 01:41	09/12/2020 12:03	10/12/2020 01:41	13,63	1	13,63	CHI
20201248719	SANTO ANTONIO DO DESCOBERTO	SN21082874	MARAJOARA	09/12/2020 12:04	09/12/2020 15:04	09/12/2020 12:04	09/12/2020 15:04	3,00	1	3,00	CHI
20201248722	NIQUELANDIA	2750070874	NIQUELANDIA SUBTRANSMISSAO	09/12/2020 12:04	09/12/2020 15:13	09/12/2020 12:04	09/12/2020 15:13	3,13	1	3,13	CHI
20201250848	CASTELANDIA	RV12026916	RIO DOS BOIS	09/12/2020 12:04	10/12/2020 08:34	09/12/2020 12:04	10/12/2020 08:34	20,49	12	245,86	CHI
20201250848	RIO VERDE	RV12026916	RIO DOS BOIS	09/12/2020 12:04	10/12/2020 08:34	09/12/2020 12:04	10/12/2020 08:34	20,49	2	40,98	CHI
20201248724	HIDROLINA	10007000063	URUACU	09/12/2020 12:05	09/12/2020 16:05	09/12/2020 12:05	09/12/2020 16:05	4,00	1	4,00	CHI
20201248953	SERRANOPOLIS	SX11049360	JATAI S1	09/12/2020 12:05	09/12/2020 18:07	09/12/2020 12:05	09/12/2020 18:07	6,02	108	650,43	CHI
20201248733	SILVANIA	DE21386415	CEPAIGO S2	09/12/2020 12:06	09/12/2020 20:23	09/12/2020 12:06	09/12/2020 20:23	8,27	2	16,55	CHI
20201248736	MINACU	10007496778	MINACU	09/12/2020 12:06	10/12/2020 09:37	09/12/2020 12:06	10/12/2020 09:37	21,51	1	21,51	CHI
20201249004	CALDAS NOVAS	CN12246620	SERRA DE CALDAS	09/12/2020 12:07	09/12/2020 15:38	09/12/2020 12:07	09/12/2020 15:25	3,29	984	3233,26	CHI
20201249004	CALDAS NOVAS	CN11067939	SERRA DE CALDAS	09/12/2020 12:07	09/12/2020 15:38	09/12/2020 12:07	09/12/2020 15:38	3,51	73	256,43	CHI
20201248759	QUIRINOPOLIS	QI32052457	QUIRINOPOLIS	09/12/2020 12:09	10/12/2020 02:20	09/12/2020 12:09	10/12/2020 02:20	14,17	9	127,56	CHI
20201248760	ARUANA	AK21310730	MOZARLANDIA	09/12/2020 12:09	09/12/2020 20:25	09/12/2020 12:09	09/12/2020 20:25	8,25	1	8,25	CHI
20201251005	CUMARI	CY11306656	CATALAO S1	09/12/2020 12:10	09/12/2020 23:13	09/12/2020 12:10	09/12/2020 23:13	11,05	17	187,79	CHI
20201252101	PIRENOPOLIS	PV12377430	GOIANESIA S1	09/12/2020 12:10	10/12/2020 09:58	09/12/2020 12:10	10/12/2020 09:58	21,79	10	217,91	CHI
20201251949	PIRENOPOLIS	20630049	SAO FRANCISCO DE GOIAS	09/12/2020 12:11	10/12/2020 00:12	09/12/2020 12:11	10/12/2020 00:12	12,01	1	12,01	CHI
20201248775	JANDIAIA	JD12308472	PALMEIRAS	09/12/2020 12:12	09/12/2020 19:11	09/12/2020 12:12	09/12/2020 19:11	6,98	2	13,96	CHI
20201249315	PLANALTINA	TL12381390	SAO JOAO D ALIANCA	09/12/2020 12:12	10/12/2020 16:01	09/12/2020 12:12	10/12/2020 16:01	27,82	21	584,12	CHI
20201249315	AGUA FRIA DE GOIAS	TL12381390	SAO JOAO D ALIANCA	09/12/2020 12:12	10/12/2020 16:01	09/12/2020 12:12	10/12/2020 16:01	27,82	3	83,45	CHI
20201248779	BALIZA	BH21360360	BOM JARDIM	09/12/2020 12:13	09/12/2020 21:46	09/12/2020 12:13	09/12/2020 21:46	9,55	2	19,09	CHI
20201248800	PORANGATU	TA12114216	NOVO PLANALTO	09/12/2020 12:16	09/12/2020 13:46	09/12/2020 12:16	09/12/2020 13:46	1,48	6	8,91	CHI
20201248801	APARECIDA DE GOIANIA	10022162907	ANHANGUERA	09/12/2020 12:17	09/12/2020 15:39	09/12/2020 12:17	09/12/2020 15:39	3,36	1	3,36	CHI
20201248804	PIRACANJUBA	60028324	PIRACANJUBA	09/12/2020 12:17	09/12/2020 16:46	09/12/2020 12:17	09/12/2020 16:46	4,47	1	4,47	CHI
20201248809	SENADOR CANEDO	10008280175	SENADOR CANEDO	09/12/2020 12:17	09/12/2020 16:01	09/12/2020 12:17	09/12/2020 16:01	3,73	1	3,73	CHI
20201249204	FAZENDA NOVA	FN12229874	JUSSARA	09/12/2020 12:17	09/12/2020 17:25	09/12/2020 12:17	09/12/2020 17:25	5,12	4	20,48	CHI
20201248814	INHUMAS	IN11012241	INHUMAS S2	09/12/2020 12:18	09/12/2020 14:00	09/12/2020 12:18	09/12/2020 14:00	1,69	67	113,34	CHI
20201249264	JESUPOLIS	SF12007222	SAO FRANCISCO DE GOIAS	09/12/2020 12:19	10/12/2020 10:15	09/12/2020 12:19	10/12/2020 10:15	21,92	20	438,49	CHI
20201249264	JARAGUA	SF12007222	SAO FRANCISCO DE GOIAS	09/12/2020 12:19	10/12/2020 10:15	09/12/2020 12:19	10/12/2020 10:15	21,92	2	43,85	CHI
20201248822	BALIZA	BH12356619	BOM JARDIM	09/12/2020 12:20	09/12/2020 15:21	09/12/2020 12:20	09/12/2020 15:21	3,01	14	42,16	CHI
20201248825	ALEXANIA	AX21000198	ALEXANIA	09/12/2020 12:20	09/12/2020 18:23	09/12/2020 12:20	09/12/2020 18:23	6,04	1	6,04	CHI
20201254476	GOIAS	GS21155845	ITABERAI S1	09/12/2020 12:20	10/12/2020 10:42	09/12/2020 12:20	10/12/2020 10:42	22,35	1	22,35	CHI
20201248830	LUZIANIA	LZ21209588	MARAJOARA	09/12/2020 12:21	09/12/2020 14:13	09/12/2020 12:21	09/12/2020 14:13	1,87	1	1,87	CHI
20201248872	GOIANIA	GN11001072	GOIANIA LESTE S3	09/12/2020 12:21	09/12/2020 14:07	09/12/2020 12:21	09/12/2020 14:07	1,75	131	229,69	CHI
20201248839	LUZIANIA	10020766490	RIO VERMELHO	09/12/2020 12:23	09/12/2020 17:09	09/12/2020 12:23	09/12/2020 17:09	4,76	1	4,76	CHI
20201248840	MARA ROSA	MQ21170949	MARA ROSA	09/12/2020 12:23	09/12/2020 20:49	09/12/2020 12:23	09/12/2020 20:49	8,43	1	8,43	CHI
20201249297	LUZIANIA	LZ12153292	VIANOPOLIS	09/12/2020 12:23	09/12/2020 18:04	09/12/2020 12:23	09/12/2020 18:04	5,68	14	79,46	CHI
20201248861	SAO SIMAO	10005711477	CACHOEIRA ALTA	09/12/2020 12:26	09/12/2020 19:29	09/12/2020 12:26	09/12/2020 19:29	7,04	1	7,04	CHI
20201248863	ITAPURANGA	IK21220306	ITAPURANGA	09/12/2020 12:27	09/12/2020 16:38	09/12/2020 12:27	09/12/2020 16:38	4,18	3	12,54	CHI
20201248871	NIQUELANDIA	NQ12147615RE	URUACU	09/12/2020 12:27	10/12/2020 15:29	09/12/2020 12:27	10/12/2020 15:29	27,04	329	8895,70	CHI
20201248871	NIQUELANDIA	NQ12147615RE	URUACU	09/12/2020 12:27	10/12/2020 15:29	09/12/2020 18:50	10/12/2020 15:29	20,66	1	20,66	CHI
20201249201	PLANALTINA	PI12375541	PLANALTINA	09/12/2020 12:27	09/12/2020 16:18	09/12/2020 12:27	09/12/2020 16:18	3,84	190	729,76	CHI
20201248874	ITUMBARA	10018798088	PARANAIBA	09/12/2020 12:28	10/12/2020 16:14	09/12/2020 12:28	10/12/2020 16:14	27,76	1	27,76	CHI
20201248875	GOIANIA	16733150	GOIANIA LESTE S3	09/12/2020 12:28	09/12/2020 16:06	09/12/2020 12:28	09/12/2020 16:06	3,62	1	3,62	CHI
20201248877	RIO VERDE	630186364	CABRIUVA S1	09/12/2020 12:29	09/12/2020 23:50	09/12/2020 12:29	09/12/2020 23:50	11,35	1	11,35	CHI
20201248981	MARA ROSA	MQ12208421	MARA ROSA	09/12/2020 12:29	09/12/2020 15:32	09/12/2020 12:29	09/12/2020 15:32	3,03	14	42,48	CHI
20201249022	SAO LUIZ DO NORTE	SZ12115033	BARRO ALTO	09/12/2020 12:29	09/12/2020 18:57	09/12/2020 12:29	09/12/2020 18:57	6,46	9	58,18	CHI
20201249022	HIDROLINA	SZ12115033	BARRO ALTO	09/12/2020 12:29	09/12/2020 18:57	09/12/2020 12:29	09/12/2020 18:57	6,46	1	6,46	CHI

20201254880	RIO VERDE	RV21154018	SANTA HELENA S1	09/12/2020 12:29	10/12/2020 12:49	09/12/2020 12:29	10/12/2020 12:49	24,32	1	24,32	CHI
20201248892	ITABERAI	10005541431	ITABERAI S2	09/12/2020 12:31	09/12/2020 16:04	09/12/2020 12:31	09/12/2020 16:04	3,55	1	3,55	CHI
20201248893	IVOLANDIA	IV21231093	IPORA	09/12/2020 12:31	09/12/2020 15:57	09/12/2020 12:31	09/12/2020 15:57	3,42	1	3,42	CHI
20201248894	CAMPESTRE DE GOIAS	CG12252073	TRINDADE	09/12/2020 12:31	09/12/2020 16:50	09/12/2020 12:31	09/12/2020 16:50	4,31	118	508,12	CHI
20201248897	ANAPOLIS	AN21001005	ANAPOLIS UNIVERSITARIO S2	09/12/2020 12:31	10/12/2020 10:04	09/12/2020 12:31	10/12/2020 10:04	21,54	1	21,54	CHI
20201248902	ITUMBIARA	IT21033796	CACHOEIRA DOURADA	09/12/2020 12:32	09/12/2020 20:45	09/12/2020 12:32	09/12/2020 20:45	8,21	1	8,21	CHI
20201248904	JATAI	290005528	JATAI S2	09/12/2020 12:32	10/12/2020 12:00	09/12/2020 12:32	10/12/2020 12:00	23,47	1	23,47	CHI
20201249521	SIMOLANDIA	SA12168083	IACIARA S2	09/12/2020 12:32	10/12/2020 00:47	09/12/2020 12:32	10/12/2020 00:47	12,24	40	489,44	CHI
20201248909	ITUMBIARA	690305072	BOM JESUS DE GOIAS	09/12/2020 12:33	09/12/2020 23:27	09/12/2020 12:33	09/12/2020 23:27	10,91	1	10,91	CHI
20201248910	INHUMAS	30168650	INHUMAS S2	09/12/2020 12:33	09/12/2020 20:27	09/12/2020 12:33	09/12/2020 20:27	7,90	1	7,90	CHI
20201248912	CABECEIRAS	CW21184509	ITUIQUIRA	09/12/2020 12:33	09/12/2020 20:02	09/12/2020 12:33	09/12/2020 20:02	7,48	1	7,48	CHI
20201248915	ORIZONA	2060008147	PIRES DO RIO S2	09/12/2020 12:34	10/12/2020 12:01	09/12/2020 12:34	10/12/2020 12:01	23,46	1	23,46	CHI
20201248916	FORMOSA	10017842210	ITUIQUIRA	09/12/2020 12:34	09/12/2020 16:04	09/12/2020 12:34	09/12/2020 16:04	3,51	1	3,51	CHI
20201249114	CAIAPONIA	CP12245300	CAIAPONIA	09/12/2020 12:34	09/12/2020 15:02	09/12/2020 12:34	09/12/2020 15:02	2,46	38	93,33	CHI
20201248920	SANTO ANTONIO DO DESCOBERTO	2210017835	AGUAS LINDAS DE GOIAS S2	09/12/2020 12:35	09/12/2020 15:16	09/12/2020 12:35	09/12/2020 15:16	2,68	1	2,68	CHI
20201248923	ITAJA	IJ12200626	ITAJA S2	09/12/2020 12:35	09/12/2020 15:23	09/12/2020 12:35	09/12/2020 15:23	2,80	7	19,57	CHI
20201249103	FLORES DE GOIAS	FB12204157	FLORES DE GOIAS	09/12/2020 12:35	09/12/2020 19:25	09/12/2020 12:35	09/12/2020 19:25	6,83	13	88,73	CHI
20201249745	FAINA	FC12158800	GOIAS	09/12/2020 12:35	09/12/2020 17:39	09/12/2020 12:35	09/12/2020 17:39	5,06	17	86,10	CHI
20201248929	ARUANA	2380007828	ARUANA	09/12/2020 12:36	10/12/2020 11:56	09/12/2020 12:36	10/12/2020 11:56	23,33	1	23,33	CHI
20201248933	ANAPOLIS	AN21262484	ANAPOLIS UNIVERSITARIO S1	09/12/2020 12:36	09/12/2020 18:42	09/12/2020 12:36	09/12/2020 18:42	6,08	1	6,08	CHI
20201248938	APARECIDA DE GOIANIA	10026156251	ANHANGUERA	09/12/2020 12:37	09/12/2020 14:26	09/12/2020 12:37	09/12/2020 14:26	1,81	1	1,81	CHI
20201248941	GOIANESIA	GE12115059	GOIANESIA S2	09/12/2020 12:38	09/12/2020 18:27	09/12/2020 12:38	09/12/2020 18:27	5,82	1	5,82	CHI
20201248943	JATAI	JT21348805	JATAI S1	09/12/2020 12:38	10/12/2020 08:20	09/12/2020 12:38	10/12/2020 08:20	19,69	1	19,69	CHI
20201248944	GOIANIA	11530406	CARAJAS S2	09/12/2020 12:38	09/12/2020 16:09	09/12/2020 12:38	09/12/2020 16:09	3,51	1	3,51	CHI
20201248945	MINEIROS	MY21324353	PARQUE DAS EMAS	09/12/2020 12:38	10/12/2020 05:03	09/12/2020 12:38	10/12/2020 05:03	16,40	1	16,40	CHI
20201248947	QUIRINOPOLIS	QI12360912LD	QUIRINOPOLIS	09/12/2020 12:38	09/12/2020 18:58	09/12/2020 12:38	09/12/2020 18:58	6,32	34	214,86	CHI
20201248947	RIO VERDE	QI12360912LD	QUIRINOPOLIS	09/12/2020 12:38	09/12/2020 18:58	09/12/2020 12:38	09/12/2020 18:58	6,32	19	120,07	CHI
20201248949	RIO VERDE	RV21279417	ACREUNA	09/12/2020 12:38	09/12/2020 19:45	09/12/2020 12:38	09/12/2020 19:45	7,10	1	7,10	CHI
20201248955	GOIANIA	SW21071757	GOIANIA LESTE S3	09/12/2020 12:39	10/12/2020 07:16	09/12/2020 12:39	10/12/2020 07:16	18,62	1	18,62	CHI
20201245433	MARA ROSA	SG12321954	SANTA TEREZINHA	09/12/2020 12:40	10/12/2020 09:12	09/12/2020 12:40	10/12/2020 09:12	20,53	15	307,93	CHI
20201245433	CAMPOS VERDES	SG12321954	SANTA TEREZINHA	09/12/2020 12:40	10/12/2020 09:12	09/12/2020 12:40	10/12/2020 09:12	20,53	1	20,53	CHI
20201245433	SANTA TEREZINHA DE GOIAS	SG12321954	SANTA TEREZINHA	09/12/2020 12:40	10/12/2020 09:12	09/12/2020 12:40	10/12/2020 09:12	20,53	14	287,40	CHI
20201248958	ESTRELA DO NORTE	ET21419816	MARA ROSA	09/12/2020 12:40	09/12/2020 17:44	09/12/2020 12:40	09/12/2020 17:44	5,06	1	5,06	CHI
20201249446	MUNDO NOVO DE GOIAS	MH12274980	NOVA CRIXAS	09/12/2020 12:40	10/12/2020 00:15	09/12/2020 12:40	10/12/2020 00:15	11,57	3	34,71	CHI
20201248970	PALMINOPOLIS	PP12197365	PALMEIRAS	09/12/2020 12:42	09/12/2020 15:56	09/12/2020 12:42	09/12/2020 15:56	3,23	6	19,36	CHI
20201248972	ITAPACI	IW12044978	ITAPACI	09/12/2020 12:42	10/12/2020 09:25	09/12/2020 12:42	10/12/2020 09:25	20,70	6	124,22	CHI
20201251461	JARAGUA	JA12017440	SAO FRANCISCO DE GOIAS	09/12/2020 12:44	10/12/2020 08:22	09/12/2020 12:44	10/12/2020 08:22	19,62	92	1805,24	CHI
20201248985	SILVANIA	SV21254604	VIANOPOLIS	09/12/2020 12:45	09/12/2020 16:42	09/12/2020 12:45	09/12/2020 16:42	3,93	1	3,93	CHI
20201248988	GOIANIA	10005745630	GOYA S1	09/12/2020 12:46	09/12/2020 15:28	09/12/2020 12:46	09/12/2020 15:28	2,68	1	2,68	CHI
20201248989	ITAPIRAPUA	IU12018844	MATRINCHA	09/12/2020 12:47	09/12/2020 16:59	09/12/2020 12:47	09/12/2020 16:59	4,20	1	4,20	CHI
20201248992	SILVANIA	SV21156958	VIANOPOLIS	09/12/2020 12:47	09/12/2020 16:00	09/12/2020 12:47	09/12/2020 16:00	3,20	1	3,20	CHI
20201249010	GOIANIA	11051360	ATLANTICO S1	09/12/2020 12:49	09/12/2020 16:50	09/12/2020 12:49	09/12/2020 16:50	4,01	1	4,01	CHI
20201250533	ABADIA DE GOIAS	AO12007317	INDEPENDENCIA S2	09/12/2020 12:49	09/12/2020 18:08	09/12/2020 12:49	09/12/2020 18:08	5,31	2	10,62	CHI
20201250804	PROFESSOR JAMIL SAFADY	PJ12074215	ROCHEDO	09/12/2020 12:49	11/12/2020 12:51	10/12/2020 20:05	11/12/2020 12:25	16,33	1	16,33	CHI
20201250804	PROFESSOR JAMIL SAFADY	JS12074215	ROCHEDO	09/12/2020 12:49	11/12/2020 12:51	09/12/2020 12:49	11/12/2020 12:51	48,04	2	96,07	CHI
20201249029	PIRACANJUBA	PJ12263455	PIRACANJUBA	09/12/2020 12:51	10/12/2020 12:01	09/12/2020 12:51	10/12/2020 12:01	23,16	8	185,32	CHI
20201249602	SANTA ROSA DE GOIAS	SR12019009	INHUMAS S1	09/12/2020 12:53	09/12/2020 16:17	09/12/2020 12:53	09/12/2020 16:17	3,40	66	224,24	CHI
20201249602	TAQUARAL DE GOIAS	SR12019009	INHUMAS S1	09/12/2020 12:53	09/12/2020 16:17	09/12/2020 12:53	09/12/2020 16:17	3,40	45	152,89	CHI
20201249602	JARAGUA	SR12019009	INHUMAS S1	09/12/2020 12:53	09/12/2020 16:17	09/12/2020 12:53	09/12/2020 16:17	3,40	2	6,80	CHI
20201249047	GOIAS	GS21348103	ITABERAI S1	09/12/2020 12:54	09/12/2020 15:00	09/12/2020 12:54	09/12/2020 15:00	2,09	1	2,09	CHI
20201249048	IACIARA	IA21253220	FLORES DE GOIAS	09/12/2020 12:54	10/12/2020 18:13	09/12/2020 12:54	10/12/2020 18:13	29,31	1	29,31	CHI

20201249052	HEITORAI	HE12195531	ITAPURANGA	09/12/2020 12:55	10/12/2020 12:20	09/12/2020 12:55	10/12/2020 12:20	23,41	1	23,41	CHI
20201249057	PALESTINA DE GOIAS	PY21086859	PALESTINA	09/12/2020 12:56	09/12/2020 23:27	09/12/2020 12:56	09/12/2020 23:27	10,51	1	10,51	CHI
20201249061	AGUA LIMPA	AL12245823	VILA CORUMBA	09/12/2020 12:57	09/12/2020 20:11	09/12/2020 12:57	09/12/2020 20:11	7,24	1	7,24	CHI
20201249063	CALDAS NOVAS	10009185605	SERRA DE CALDAS	09/12/2020 12:58	10/12/2020 02:33	09/12/2020 12:58	10/12/2020 02:33	13,58	1	13,58	CHI
20201249064	CAIAPONIA	CP21357497	PALESTINA	09/12/2020 12:58	09/12/2020 15:04	09/12/2020 12:58	09/12/2020 15:04	2,09	1	2,09	CHI
20201249067	CRISTALINA	KR21133631	CRISTALINA S2	09/12/2020 12:59	10/12/2020 09:24	09/12/2020 12:59	10/12/2020 09:24	20,41	1	20,41	CHI
20201249121	ALTO HORIZONTE	AJ12320992RE	SANTA TEREZINHA	09/12/2020 12:59	09/12/2020 16:52	09/12/2020 12:59	09/12/2020 16:52	3,88	47	182,15	CHI
20201250936	ESTRELA DO NORTE	ET12391908	MARA ROSA	09/12/2020 12:59	09/12/2020 19:22	09/12/2020 12:59	09/12/2020 19:22	6,37	2	12,74	CHI
20201250936	MARA ROSA	ET12391908	MARA ROSA	09/12/2020 12:59	09/12/2020 19:22	09/12/2020 12:59	09/12/2020 19:22	6,37	1	6,37	CHI
20201252636	GOIATUBA	GT11320301	GOIATUBA S2	09/12/2020 12:59	10/12/2020 17:45	09/12/2020 12:59	10/12/2020 17:45	28,76	21	603,95	CHI
20201249091	MONTES CLAROS DE GOIAS	ME21138678	IPORA	09/12/2020 13:00	09/12/2020 15:30	09/12/2020 13:00	09/12/2020 15:30	2,50	1	2,50	CHI
20201249093	CIDADE OCIDENTAL	LZ12060260	MARAJOARA	09/12/2020 13:00	09/12/2020 16:21	09/12/2020 13:00	09/12/2020 16:21	3,34	6	20,06	CHI
20201249102	LUZIANIA	120289507	RIO VERMELHO	09/12/2020 13:01	09/12/2020 14:25	09/12/2020 13:01	09/12/2020 14:25	1,40	1	1,40	CHI
20201249105	APARECIDA DE GOIANIA	10005413069	ANHANGUERA	09/12/2020 13:01	09/12/2020 14:39	09/12/2020 13:01	09/12/2020 14:39	1,63	1	1,63	CHI
20201249519	ANAPOLIS	AN11403262	ANAPOLIS UNIVERSITARIO S2	09/12/2020 13:02	09/12/2020 17:36	09/12/2020 13:02	09/12/2020 17:36	4,55	47	214,08	CHI
20201249116	SANTA HELENA DE GOIAS	10027328307	IPEGUARI	09/12/2020 13:03	10/12/2020 07:36	09/12/2020 13:03	10/12/2020 07:36	18,54	1	18,54	CHI
20201249119	PONTALINA	PK12099030	PONTALINA	09/12/2020 13:03	09/12/2020 19:02	09/12/2020 13:03	09/12/2020 19:02	5,97	4	23,89	CHI
20201249447	MUNDO NOVO DE GOIAS	MH11274936	NOVA CRIXAS	09/12/2020 13:03	09/12/2020 15:06	09/12/2020 13:03	09/12/2020 15:06	2,04	1	2,04	CHI
20201249123	GOIANIA	11970066	CAMPINAS S2	09/12/2020 13:04	09/12/2020 16:22	09/12/2020 13:04	09/12/2020 16:22	3,29	1	3,29	CHI
20201249139	CAIAPONIA	MV13123330	MONTIVIDIU T	09/12/2020 13:04	10/12/2020 14:01	09/12/2020 21:25	10/12/2020 10:32	13,12	18	236,21	CHI
20201249139	MONTIVIDIU	MV13123330	MONTIVIDIU T	09/12/2020 13:04	10/12/2020 14:01	09/12/2020 21:25	10/12/2020 10:32	13,12	43	564,28	CHI
20201249139	MONTIVIDIU	MV13346070	MONTIVIDIU T	09/12/2020 13:04	10/12/2020 14:01	10/12/2020 12:02	10/12/2020 14:01	1,98	16	31,61	CHI
20201249139	CAIAPONIA	MV13346070	MONTIVIDIU T	09/12/2020 13:04	10/12/2020 14:01	10/12/2020 12:02	10/12/2020 14:01	1,98	5	9,88	CHI
20201249139	RIO VERDE	MV13346070	MONTIVIDIU T	09/12/2020 13:04	10/12/2020 14:01	10/12/2020 12:02	10/12/2020 14:01	1,98	2	3,95	CHI
20201249129	QUIRINOPOLIS	80021001	QUIRINOPOLIS	09/12/2020 13:05	09/12/2020 16:25	09/12/2020 13:05	09/12/2020 16:25	3,32	1	3,32	CHI
20201249542	DIORAMA	DI12065689	IPORA	09/12/2020 13:06	09/12/2020 17:37	09/12/2020 13:06	09/12/2020 17:37	4,51	15	67,60	CHI
20201249143	URUACU	UR21003382	URUACU	09/12/2020 13:08	09/12/2020 13:52	09/12/2020 13:08	09/12/2020 13:52	0,73	1	0,73	CHI
20201249148	ITAPURANGA	IK21299481	ITAPURANGA	09/12/2020 13:08	10/12/2020 00:15	09/12/2020 13:08	10/12/2020 00:15	11,10	2	22,20	CHI
20201252535	MINACU	IH12242191	MINACU	09/12/2020 13:08	10/12/2020 13:36	09/12/2020 13:08	10/12/2020 13:36	24,46	8	195,69	CHI
20201249149	RIO VERDE	RV12260156	RIO VERDE S1	09/12/2020 13:09	09/12/2020 21:56	09/12/2020 13:09	09/12/2020 21:56	8,78	1	8,78	CHI
20201249208	SANTA HELENA DE GOIAS	SH12271338	ACREUNA	09/12/2020 13:09	10/12/2020 16:40	09/12/2020 13:09	10/12/2020 16:40	27,51	7	192,59	CHI
20201249911	OURO VERDE DE GOIAS	OV12215905	NEROPOLIS S2	09/12/2020 13:09	10/12/2020 13:46	09/12/2020 13:09	10/12/2020 13:46	24,61	10	246,06	CHI
20201250326	TRINDADE	TR32037034	TRINDADE	09/12/2020 13:10	09/12/2020 21:05	09/12/2020 13:10	09/12/2020 21:05	7,91	7	55,35	CHI
20201249159	INACIOLANDIA	ID21366457	CACHOEIRA DOURADA	09/12/2020 13:11	09/12/2020 16:55	09/12/2020 13:11	09/12/2020 16:55	3,73	1	3,73	CHI
20201244658	JATAI	JT12092395	JATAI S1	09/12/2020 13:14	09/12/2020 17:54	09/12/2020 13:14	09/12/2020 17:54	4,66	95	443,12	CHI
20201249180	ANAPOLIS	21314044	ANAPOLIS UNIVERSITARIO S2	09/12/2020 13:15	09/12/2020 18:28	09/12/2020 13:15	09/12/2020 18:28	5,20	1	5,20	CHI
20201249182	CIDADE OCIDENTAL	LZ21037903	MARAJOARA	09/12/2020 13:16	09/12/2020 15:09	09/12/2020 13:16	09/12/2020 15:09	1,88	2	3,76	CHI
20201249183	ALEXANIA	AX31155288	CORUMBA	09/12/2020 13:16	09/12/2020 15:00	09/12/2020 13:16	09/12/2020 15:00	1,73	2	3,45	CHI
20201249186	GOIAS	GS12183485	GOIAS	09/12/2020 13:16	09/12/2020 18:14	09/12/2020 13:16	09/12/2020 18:14	4,95	4	19,81	CHI
20201249187	GOIANIA	10020955039	GOYA S1	09/12/2020 13:16	09/12/2020 14:56	09/12/2020 13:16	09/12/2020 14:56	1,66	1	1,66	CHI
20201249189	PORTEIRAO	BJ12305324	RIO DOS BOIS	09/12/2020 13:17	09/12/2020 22:39	09/12/2020 13:17	09/12/2020 22:39	9,36	1	9,36	CHI
20201249192	AGUA FRIA DE GOIAS	TL21371155	SAO JOAO D ALIANCA	09/12/2020 13:17	09/12/2020 22:26	09/12/2020 13:17	09/12/2020 22:26	9,14	1	9,14	CHI
20201249195	ITABERAI	50035629	ITABERAI S2	09/12/2020 13:18	09/12/2020 16:59	09/12/2020 13:18	09/12/2020 16:59	3,67	1	3,67	CHI
20201249197	CATALAO	CT12267107	CATALAO S1	09/12/2020 13:19	09/12/2020 19:00	09/12/2020 13:19	09/12/2020 19:00	5,68	3	17,05	CHI
20201249199	SAO LUIS DE MONTES BELOS	SL12154565	SAO LUIZ DOS MONTES BELOS	09/12/2020 13:19	09/12/2020 17:43	09/12/2020 13:19	09/12/2020 17:43	4,39	21	92,28	CHI
20201249202	BONOPOLIS	BX12272118	SAO MIGUEL DO ARAGUAIA	09/12/2020 13:19	09/12/2020 17:23	09/12/2020 13:19	09/12/2020 17:23	4,06	1	4,06	CHI
20201249212	SANTO ANTONIO DO DESCOBERTO	7638899	AGUAS LINDAS DE GOIAS S2	09/12/2020 13:20	09/12/2020 20:08	09/12/2020 13:20	09/12/2020 20:08	6,79	1	6,79	CHI
20201249504	ITAGUARI	IC12300154	ITABERAI S1	09/12/2020 13:20	10/12/2020 17:51	09/12/2020 13:20	10/12/2020 17:51	28,51	11	313,56	CHI
20201248497	MORRINHOS	MR11000045	MORRINHOS	09/12/2020 13:21	10/12/2020 17:11	09/12/2020 13:21	10/12/2020 17:11	27,82	51	1418,68	CHI
20201249216	SENADOR CANEDO	SW11076743	CEPAIGO S1	09/12/2020 13:21	10/12/2020 00:00	09/12/2020 21:26	10/12/2020 00:00	2,57	12	30,80	CHI
20201249220	ITUMBIAIRA	690380288	PARANAIBA	09/12/2020 13:22	09/12/2020 17:22	09/12/2020 13:22	09/12/2020 17:22	3,99	1	3,99	CHI

20201249222	PARAUNA	EU21000086	ACREUNA	09/12/2020 13:22	09/12/2020 23:50	09/12/2020 13:22	09/12/2020 23:50	10,45	1	10,45	CHI
20201249232	APARECIDA DE GOIANIA	AP11395336	INDEPENDENCIA S1	09/12/2020 13:25	09/12/2020 16:15	09/12/2020 13:25	09/12/2020 16:15	2,83	89	251,92	CHI
20201249244	CALDAS NOVAS	760241569	SERRA DE CALDAS	09/12/2020 13:26	10/12/2020 03:07	09/12/2020 13:26	10/12/2020 03:07	13,68	1	13,68	CHI
20201249245	ITARUMA	IM21271703	CACHOEIRA ALTA	09/12/2020 13:26	10/12/2020 14:09	09/12/2020 13:26	10/12/2020 14:09	24,70	2	49,41	CHI
20201250744	FORMOSO	ET12143681	MARA ROSA	09/12/2020 13:26	10/12/2020 04:15	09/12/2020 13:26	10/12/2020 04:15	14,81	13	192,59	CHI
20201249251	ANAPOLIS	AN21018350	NEROPOLIS S2	09/12/2020 13:28	09/12/2020 22:04	09/12/2020 13:28	09/12/2020 22:04	8,60	1	8,60	CHI
20201249252	NIQUELANDIA	NQ21237369	URUACU	09/12/2020 13:28	09/12/2020 18:00	09/12/2020 13:28	09/12/2020 18:00	4,53	1	4,53	CHI
20201249259	AMARALINA	LC12215796	MARA ROSA	09/12/2020 13:28	09/12/2020 16:15	09/12/2020 13:28	09/12/2020 16:15	2,78	13	36,09	CHI
20201249261	INDIARA	10013205267	EDEIA	09/12/2020 13:29	10/12/2020 13:07	09/12/2020 13:29	10/12/2020 13:07	23,62	1	23,62	CHI
20201249262	MOSSAMEDES	ND12299618	ITABERAÍ S2	09/12/2020 13:29	09/12/2020 21:22	09/12/2020 13:29	09/12/2020 21:22	7,87	18	141,65	CHI
20201249271	PALMEIRAS DE GOIAS	PL12231839	PALMEIRAS	09/12/2020 13:31	09/12/2020 16:18	09/12/2020 13:31	09/12/2020 16:18	2,78	2	5,56	CHI
20201249275	JATAI	JT12139261	JATAI S1	09/12/2020 13:31	10/12/2020 09:30	09/12/2020 13:31	10/12/2020 09:30	19,97	1	19,97	CHI
20201249277	RIO VERDE	630424548	RIO VERDE S2	09/12/2020 13:31	10/12/2020 10:51	09/12/2020 13:31	10/12/2020 10:51	21,32	1	21,32	CHI
20201249859	URUACU	UR12049780	URUACU	09/12/2020 13:32	10/12/2020 04:12	09/12/2020 13:32	10/12/2020 00:35	11,04	187	2065,00	CHI
20201249859	URUACU	UR11135596	URUACU	09/12/2020 13:32	10/12/2020 04:12	10/12/2020 03:06	10/12/2020 04:12	1,10	187	205,08	CHI
20201249286	MORRINHOS	MR12325420	MORRINHOS	09/12/2020 13:33	09/12/2020 19:27	09/12/2020 13:33	09/12/2020 19:27	5,89	1	5,89	CHI
20201249288	NOVA CRIXAS	NA21181583	NOVA CRIXAS	09/12/2020 13:33	09/12/2020 21:00	09/12/2020 13:33	09/12/2020 21:00	7,44	2	14,87	CHI
20201249544	ANAPOLIS	AN12258789	ANAPOLIS UNIVERSITARIO S1	09/12/2020 13:33	10/12/2020 08:15	09/12/2020 13:33	10/12/2020 08:15	18,69	13	242,95	CHI
20201249291	FLORES DE GOIAS	FB12286863	FLORES DE GOIAS	09/12/2020 13:34	09/12/2020 15:40	09/12/2020 13:34	09/12/2020 15:40	2,09	78	163,32	CHI
20201249293	TURVANIA	1220025474	FIRMINOPOLIS S2	09/12/2020 13:34	10/12/2020 11:30	09/12/2020 13:34	10/12/2020 11:30	21,93	1	21,93	CHI
20201249305	LUZIANIA	10018328626	RIO VERMELHO	09/12/2020 13:37	09/12/2020 15:32	09/12/2020 13:37	09/12/2020 15:32	1,91	1	1,91	CHI
20201249309	GOIANIA	GN12169561	GOIANIA LESTE S2	09/12/2020 13:38	09/12/2020 16:17	09/12/2020 13:38	09/12/2020 16:17	2,64	41	108,07	CHI
20201249312	ITUMBIARA	IT10404068	ITUMBIARA VELHA S1	09/12/2020 13:38	10/12/2020 12:46	09/12/2020 13:38	09/12/2020 17:39	4,02	7	28,13	CHI
20201249312	ITUMBIARA	IT10404068	ITUMBIARA VELHA S1	09/12/2020 13:38	10/12/2020 12:46	09/12/2020 19:10	09/12/2020 19:16	0,09	7	0,63	CHI
20201249312	ITUMBIARA	IT13296775	ITUMBIARA VELHA S1	09/12/2020 13:38	10/12/2020 12:46	09/12/2020 13:38	10/12/2020 01:13	11,59	102	1182,69	CHI
20201249312	ITUMBIARA	IT13103452	ITUMBIARA VELHA S1	09/12/2020 13:38	10/12/2020 12:46	09/12/2020 13:38	10/12/2020 02:05	12,46	114	1420,50	CHI
20201249312	ITUMBIARA	IT12296774	ITUMBIARA VELHA S1	09/12/2020 13:38	10/12/2020 12:46	09/12/2020 13:38	10/12/2020 12:46	23,13	2	46,27	CHI
20201249311	CACHOEIRA ALTA	CA21000009	CACHOEIRA ALTA	09/12/2020 13:40	09/12/2020 17:19	09/12/2020 13:40	09/12/2020 17:19	3,64	1	3,64	CHI
20201249316	GOIANIA	14987582	GOYA S2	09/12/2020 13:41	09/12/2020 18:16	09/12/2020 13:41	09/12/2020 18:16	4,57	1	4,57	CHI
20201249321	NIQUELANDIA	NQ12268706	NIQUELANDIA SUBTRANSMISSAO	09/12/2020 13:43	09/12/2020 21:39	09/12/2020 13:43	09/12/2020 21:39	7,92	1	7,92	CHI
20201250073	LUZIANIA	LZ12149864	RIO VERMELHO	09/12/2020 13:43	09/12/2020 17:57	09/12/2020 13:43	09/12/2020 17:56	4,21	198	833,64	CHI
20201250073	LUZIANIA	LZ11149862	RIO VERMELHO	09/12/2020 13:43	09/12/2020 17:57	09/12/2020 13:43	09/12/2020 17:57	4,23	188	795,14	CHI
20201249325	APARECIDA DE GOIANIA	200613522	ANHANGUERA	09/12/2020 13:44	09/12/2020 16:43	09/12/2020 13:44	09/12/2020 16:43	2,98	1	2,98	CHI
20201249326	URUACU	UR12088731	URUACU	09/12/2020 13:44	09/12/2020 15:53	09/12/2020 13:44	09/12/2020 15:53	2,14	1	2,14	CHI
20201249329	APARECIDA DE GOIANIA	16827508	REAL S2	09/12/2020 13:45	09/12/2020 17:15	09/12/2020 13:45	09/12/2020 17:15	3,50	1	3,50	CHI
20201249332	NIQUELANDIA	NQ21146081	URUACU	09/12/2020 13:45	09/12/2020 20:44	09/12/2020 13:45	09/12/2020 20:44	6,97	1	6,97	CHI
20201249335	SANTO ANTONIO DA BARRA	BZ12295806	ACREUNA	09/12/2020 13:45	10/12/2020 00:24	09/12/2020 13:45	10/12/2020 00:24	10,64	1	10,64	CHI
20201249340	APORE	AE11063739	ITAJA S1	09/12/2020 13:46	09/12/2020 19:28	09/12/2020 13:46	09/12/2020 19:28	5,69	100	569,11	CHI
20201248335	CATURAI	IN12000128LD	INHUMAS S1	09/12/2020 13:47	09/12/2020 23:33	09/12/2020 13:47	09/12/2020 23:33	9,76	18	175,60	CHI
20201248335	INHUMAS	IN12000128LD	INHUMAS S1	09/12/2020 13:47	09/12/2020 23:33	09/12/2020 13:47	09/12/2020 23:33	9,76	1	9,76	CHI
20201249346	APARECIDA DE GOIANIA	10007198181	INDEPENDENCIA S1	09/12/2020 13:47	09/12/2020 15:02	09/12/2020 13:47	09/12/2020 15:02	1,23	1	1,23	CHI
20201249347	PALMEIRAS DE GOIAS	PL11277547	PALMEIRAS	09/12/2020 13:47	09/12/2020 15:06	09/12/2020 13:47	09/12/2020 15:06	1,30	1	1,30	CHI
20201249348	ITUMBIARA	IT12404753	PARANAIBA	09/12/2020 13:48	09/12/2020 21:14	09/12/2020 13:48	09/12/2020 21:14	7,43	1	7,43	CHI
20201249757	BELA VISTA DE GOIAS	BV11187573	BELA VISTA S2	09/12/2020 13:48	09/12/2020 15:43	09/12/2020 13:48	09/12/2020 15:43	1,91	40	76,47	CHI
20201250051	MINACU	IH12208344	MINACU	09/12/2020 13:48	11/12/2020 03:57	09/12/2020 13:48	11/12/2020 03:57	38,14	27	1029,73	CHI
20201250051	TROMBAS	IH12208344	MINACU	09/12/2020 13:48	11/12/2020 03:57	09/12/2020 13:48	11/12/2020 03:57	38,14	2	76,28	CHI
20201249355	SAO LUIZ DO NORTE	SZ12236801	BARRO ALTO	09/12/2020 13:49	09/12/2020 23:51	09/12/2020 13:49	09/12/2020 23:51	10,03	22	220,73	CHI
20201249358	BONOPOLIS	BX12334612	SAO MIGUEL DO ARAGUAIA	09/12/2020 13:49	09/12/2020 16:43	09/12/2020 13:49	09/12/2020 16:43	2,89	2	5,78	CHI
20201249383	NOVA CRIXAS	NA12381800	NOVA CRIXAS	09/12/2020 13:50	09/12/2020 15:06	09/12/2020 13:50	09/12/2020 15:06	1,26	2	2,52	CHI
20201249366	PARAUNA	980000609	PARAUNA	09/12/2020 13:51	09/12/2020 21:56	09/12/2020 13:51	09/12/2020 21:56	8,08	1	8,08	CHI
20201249369	TRINDADE	40142139	TRINDADE	09/12/2020 13:51	09/12/2020 15:11	09/12/2020 13:51	09/12/2020 15:11	1,32	1	1,32	CHI

20201249370	PADRE BERNARDO	PB11336079	PADRE BERNARDO	09/12/2020 13:51	09/12/2020 14:59	09/12/2020 13:51	09/12/2020 14:59	1,12	8	8,98	CHI
20201249378	CACHOEIRA ALTA	CA21075277	CACHOEIRA ALTA	09/12/2020 13:53	10/12/2020 10:46	09/12/2020 13:53	10/12/2020 10:46	20,88	2	41,76	CHI
20201249380	MINEIROS	MY21296287	PARQUE DAS EMAS	09/12/2020 13:53	09/12/2020 19:20	09/12/2020 13:53	09/12/2020 19:20	5,46	1	5,46	CHI
20201249871	MUNDO NOVO DE GOIAS	MH12274828	NOVA CRIXAS	09/12/2020 13:53	09/12/2020 16:06	09/12/2020 13:53	09/12/2020 16:06	2,21	15	33,12	CHI
20201249382	ARAGUAPAZ	1780012060	MOZARLANDIA	09/12/2020 13:55	09/12/2020 16:42	09/12/2020 13:55	09/12/2020 16:42	2,78	1	2,78	CHI
20201249385	TRINDADE	12353462	GOYA S2	09/12/2020 13:56	10/12/2020 03:50	09/12/2020 13:56	10/12/2020 03:50	13,90	1	13,90	CHI
20201252250	JATAI	JT21264298	JATAI S1	09/12/2020 13:56	10/12/2020 00:06	09/12/2020 13:56	10/12/2020 00:06	10,17	1	10,17	CHI
20201249678	RIO VERDE	RV12350932	CABRIUVA S2	09/12/2020 13:57	09/12/2020 20:17	09/12/2020 13:57	09/12/2020 20:17	6,32	22	139,08	CHI
20201249397	PALMEIRAS DE GOIAS	PL21000059	PALMEIRAS	09/12/2020 13:58	09/12/2020 19:54	09/12/2020 13:58	09/12/2020 19:54	5,93	1	5,93	CHI
20201249402	CALDAS NOVAS	760209820	CALDAS NOVAS S1	09/12/2020 13:59	10/12/2020 12:18	09/12/2020 13:59	10/12/2020 12:18	22,32	1	22,32	CHI
20201249406	FLORES DE GOIAS	9620004418	IACIARA S2	09/12/2020 13:59	10/12/2020 10:42	09/12/2020 13:59	10/12/2020 10:42	20,71	1	20,71	CHI
20201249408	CATALAO	1990107622	CATALAO S2	09/12/2020 14:00	09/12/2020 16:37	09/12/2020 14:00	09/12/2020 16:37	2,61	1	2,61	CHI
20201249410	JATAI	JT21233046	JATAI S1	09/12/2020 14:00	10/12/2020 10:45	09/12/2020 14:00	10/12/2020 10:45	20,74	1	20,74	CHI
20201249412	OUIDOR	10003712417	CATALAO S1	09/12/2020 14:00	09/12/2020 14:26	09/12/2020 14:00	09/12/2020 14:26	0,42	1	0,42	CHI
20201250558	CRIXAS	CX12243321	RUBIATABA	09/12/2020 14:00	10/12/2020 11:45	09/12/2020 14:00	10/12/2020 11:45	21,75	6	130,48	CHI
20201249416	GOIANIA	12708793	GOYA S1	09/12/2020 14:01	09/12/2020 16:05	09/12/2020 14:01	09/12/2020 16:05	2,06	1	2,06	CHI
20201249419	ANAPOLIS	20145287	JUNDIAI S2	09/12/2020 14:01	09/12/2020 20:58	09/12/2020 14:01	09/12/2020 20:58	6,94	1	6,94	CHI
20201249433	TRINDADE	40262595	TRINDADE	09/12/2020 14:03	10/12/2020 11:44	09/12/2020 14:03	10/12/2020 11:44	21,68	1	21,68	CHI
20201249434	GOIANIA	GN11031130	ATLANTICO S1	09/12/2020 14:03	09/12/2020 15:52	09/12/2020 14:03	09/12/2020 15:52	1,81	19	34,37	CHI
20201249436	PALMINOPOLIS	PL21167835	FIRMINOPOLIS S2	09/12/2020 14:03	10/12/2020 12:46	09/12/2020 14:03	10/12/2020 12:46	22,70	1	22,70	CHI
20201249440	QUIRINOPOLIS	80062532	QUIRINOPOLIS	09/12/2020 14:04	09/12/2020 16:16	09/12/2020 14:04	09/12/2020 16:16	2,19	1	2,19	CHI
20201249451	GOIANIA	11213292	GOIANIA LESTE S1	09/12/2020 14:05	09/12/2020 18:10	09/12/2020 14:05	09/12/2020 18:10	4,07	1	4,07	CHI
20201249454	GOIANIA	14501867	CARAJAS S1	09/12/2020 14:05	09/12/2020 16:42	09/12/2020 14:05	09/12/2020 16:42	2,60	1	2,60	CHI
20201249458	ANAPOLIS	20122871	ANAPOLIS UNIVERSITARIO S2	09/12/2020 14:06	10/12/2020 08:15	09/12/2020 14:06	10/12/2020 08:15	18,14	1	18,14	CHI
20201249491	SANTA TEREZINHA DE GOIAS	SG12202092	SANTA TEREZINHA	09/12/2020 14:06	09/12/2020 19:54	09/12/2020 14:06	09/12/2020 19:54	5,79	6	34,74	CHI
20201249556	AGUAS LINDAS DE GOIAS	LA12108709	AGUAS LINDAS DE GOIAS S1	09/12/2020 14:07	09/12/2020 16:49	09/12/2020 14:07	09/12/2020 16:49	2,69	172	462,97	CHI
20201249475	ANAPOLIS	OV21223924	NEROPOLIS S1	09/12/2020 14:09	09/12/2020 21:40	09/12/2020 14:09	09/12/2020 21:40	7,52	1	7,52	CHI
20201249479	EDEALINA	1130008232	PONTALINA	09/12/2020 14:09	10/12/2020 04:00	09/12/2020 14:09	10/12/2020 04:00	13,84	1	13,84	CHI
20201249484	CRISTALINA	KR12245975	CRISTALINA S1	09/12/2020 14:10	09/12/2020 20:53	09/12/2020 14:10	09/12/2020 20:53	6,70	4	26,81	CHI
20201249512	NIQUELANDIA	NQ12239432	URUACU	09/12/2020 14:11	09/12/2020 15:47	09/12/2020 14:11	09/12/2020 15:47	1,59	21	33,40	CHI
20201250258	CALDAS NOVAS	CN11000034	CALDAS NOVAS S2	09/12/2020 14:11	09/12/2020 18:05	09/12/2020 14:11	09/12/2020 18:05	3,89	34	132,27	CHI
20201249500	APARECIDA DE GOIANIA	10014871988	CARAJAS S1	09/12/2020 14:13	09/12/2020 16:36	09/12/2020 14:13	09/12/2020 16:36	2,37	1	2,37	CHI
20201249501	APARECIDA DE GOIANIA	10006777927	INDEPENDENCIA S2	09/12/2020 14:13	10/12/2020 01:23	09/12/2020 14:13	10/12/2020 01:23	11,15	1	11,15	CHI
20201249508	MINACU	IH11207736	MINACU	09/12/2020 14:14	10/12/2020 16:26	09/12/2020 14:14	10/12/2020 16:26	26,19	2	52,37	CHI
20201249513	MINEIROS	PW12374393	PARQUE DAS EMAS	09/12/2020 14:16	09/12/2020 16:23	09/12/2020 14:16	09/12/2020 16:23	2,11	5	10,55	CHI
20201249593	JATAI	JT12354961	JATAI S1	09/12/2020 14:16	09/12/2020 20:27	09/12/2020 14:16	09/12/2020 20:27	6,17	16	98,69	CHI
20201249517	ANAPOLIS	AN21297750	ANAPOLIS UNIVERSITARIO S1	09/12/2020 14:17	09/12/2020 19:25	09/12/2020 14:17	09/12/2020 19:25	5,13	1	5,13	CHI
20201249523	MINACU	IH21220754	MINACU	09/12/2020 14:17	11/12/2020 13:16	09/12/2020 14:17	11/12/2020 13:16	46,97	1	46,97	CHI
20201251882	CALDAS NOVAS	CN12213938	SERRA DE CALDAS	09/12/2020 14:17	09/12/2020 23:11	09/12/2020 14:17	09/12/2020 23:11	8,89	33	293,29	CHI
20201251970	FIRMINOPOLIS	TV12105311	FIRMINOPOLIS S1	09/12/2020 14:17	10/12/2020 07:23	09/12/2020 14:17	10/12/2020 07:23	17,09	6	102,56	CHI
20201249846	LUZIANIA	LZ11169006	RIO VERMELHO	09/12/2020 14:18	09/12/2020 20:25	09/12/2020 14:18	09/12/2020 20:25	6,11	81	495,13	CHI
20201249530	NOVA IGUACU DE GOIAS	UR12407359	URUACU	09/12/2020 14:19	10/12/2020 08:05	09/12/2020 14:19	10/12/2020 08:05	17,76	21	373,06	CHI
20201249530	PILAR DE GOIAS	UR12407359	URUACU	09/12/2020 14:19	10/12/2020 08:05	09/12/2020 14:19	10/12/2020 08:05	17,76	1	17,76	CHI
20201249530	URUACU	UR12407359	URUACU	09/12/2020 14:19	10/12/2020 08:05	09/12/2020 14:19	10/12/2020 08:05	17,76	29	515,18	CHI
20201250572	LUZIANIA	LZ12349110	MARAJOARA	09/12/2020 14:20	10/12/2020 08:41	09/12/2020 14:20	10/12/2020 08:41	18,34	16	293,40	CHI
20201249552	MINEIROS	MY21260411	PARQUE DAS EMAS	09/12/2020 14:22	10/12/2020 10:41	09/12/2020 14:22	10/12/2020 10:41	20,32	1	20,32	CHI
20201249554	ALEXANIA	AX21362270	ALEXANIA	09/12/2020 14:22	09/12/2020 18:07	09/12/2020 14:22	09/12/2020 18:07	3,75	1	3,75	CHI
20201249559	CAIAPONIA	CP21365191	CAIAPONIA	09/12/2020 14:22	10/12/2020 02:36	09/12/2020 14:22	10/12/2020 02:36	12,22	1	12,22	CHI
20201249564	BONOPOLIS	BX12292422	SAO MIGUEL DO ARAGUAIA	09/12/2020 14:23	09/12/2020 19:19	09/12/2020 14:23	09/12/2020 19:19	4,93	32	157,79	CHI
20201249564	PORANGATU	BX12292422	SAO MIGUEL DO ARAGUAIA	09/12/2020 14:23	09/12/2020 19:19	09/12/2020 14:23	09/12/2020 19:19	4,93	1	4,93	CHI
20201249566	IPAMERI	IP12152494RE	IPAMERI	09/12/2020 14:23	10/12/2020 10:57	09/12/2020 14:23	10/12/2020 10:57	20,56	27	555,08	CHI

20201249676	URUACU	UR12243628	MARA ROSA	09/12/2020 14:23	10/12/2020 09:24	09/12/2020 14:23	10/12/2020 09:24	19,01	3	57,03	CHI
20201250513	CRIXAS	CX12399926	RUBIATABA	09/12/2020 14:23	10/12/2020 03:35	09/12/2020 14:23	10/12/2020 03:35	13,19	18	237,37	CHI
20201249571	RIO VERDE	RV21025942	MONTIVIDIU T	09/12/2020 14:24	09/12/2020 21:18	09/12/2020 14:24	09/12/2020 21:18	6,90	1	6,90	CHI
20201251904	AMARALINA	LC12270741	SAO MIGUEL DO ARAGUAIA	09/12/2020 14:27	10/12/2020 00:41	09/12/2020 14:27	10/12/2020 00:41	10,22	10	102,24	CHI
20201249583	GOIANIA	16738860	GOYA S2	09/12/2020 14:28	09/12/2020 16:20	09/12/2020 14:28	09/12/2020 16:20	1,86	1	1,86	CHI
20201249588	GOIANIA	12906694	AEROPORTO S1	09/12/2020 14:28	09/12/2020 15:42	09/12/2020 14:28	09/12/2020 15:42	1,22	0	0,00	CHI
20201249592	NOVO GAMA	NJ21206635	PACAEMBU S2	09/12/2020 14:29	09/12/2020 15:51	09/12/2020 14:29	09/12/2020 15:51	1,36	1	1,36	CHI
20201249596	GOIANIA	10196717	AEROPORTO S1	09/12/2020 14:29	09/12/2020 17:25	09/12/2020 14:29	09/12/2020 17:25	2,93	1	2,93	CHI
20201249597	PIRACANJUBA	PJ21053524	PIRACANJUBA	09/12/2020 14:29	10/12/2020 11:14	09/12/2020 14:29	10/12/2020 11:14	20,74	1	20,74	CHI
20201249679	PALMEIRAS DE GOIAS	PL11000030	PALMEIRAS	09/12/2020 14:29	09/12/2020 16:37	09/12/2020 14:29	09/12/2020 16:37	2,13	152	323,17	CHI
20201249834	FORMOSA	FA12261997	ITUIQUIRA	09/12/2020 14:29	09/12/2020 19:25	09/12/2020 14:29	09/12/2020 19:25	4,93	61	300,53	CHI
20201249834	VILA BOA	FA12261997	ITUIQUIRA	09/12/2020 14:29	09/12/2020 19:25	09/12/2020 14:29	09/12/2020 19:25	4,93	4	19,71	CHI
20201249603	GOIANIA	11300140	CARAJAS S2	09/12/2020 14:30	09/12/2020 22:26	09/12/2020 14:30	09/12/2020 22:26	7,92	1	7,92	CHI
20201249606	RIO VERDE	630381616	RIO VERDE S1	09/12/2020 14:30	09/12/2020 17:56	09/12/2020 14:30	09/12/2020 17:56	3,42	1	3,42	CHI
20201249632	QUIRINOPOLIS	GB16419945	QUIRINOPOLIS	09/12/2020 14:30	09/12/2020 17:44	09/12/2020 14:34	09/12/2020 14:46	0,20	89	17,50	CHI
20201249632	GOUVELANDIA	GB16419945	QUIRINOPOLIS	09/12/2020 14:30	09/12/2020 17:44	09/12/2020 14:34	09/12/2020 14:46	0,20	1551	305,03	CHI
20201249632	INACIOLANDIA	01560414	QUIRINOPOLIS	09/12/2020 14:30	09/12/2020 17:44	09/12/2020 14:30	09/12/2020 17:41	3,17	14	44,41	CHI
20201249632	QUIRINOPOLIS	01560414	QUIRINOPOLIS	09/12/2020 14:30	09/12/2020 17:44	09/12/2020 14:30	09/12/2020 17:41	3,17	23	72,96	CHI
20201249632	GOUVELANDIA	01560414	QUIRINOPOLIS	09/12/2020 14:30	09/12/2020 17:44	09/12/2020 14:30	09/12/2020 17:41	3,17	11	34,89	CHI
20201249632	GOUVELANDIA	GB10414863	QUIRINOPOLIS	09/12/2020 14:30	09/12/2020 17:44	09/12/2020 14:31	09/12/2020 17:41	3,15	5	15,77	CHI
20201249632	QUIRINOPOLIS	GB16419945	QUIRINOPOLIS	09/12/2020 14:30	09/12/2020 17:44	09/12/2020 14:50	09/12/2020 17:44	2,90	89	257,78	CHI
20201249632	GOUVELANDIA	GB16419945	QUIRINOPOLIS	09/12/2020 14:30	09/12/2020 17:44	09/12/2020 14:50	09/12/2020 17:44	2,90	1551	4492,30	CHI
20201250548	SANTA CRUZ DE GOIAS	CF12020367	CRISTIANOPOLIS	09/12/2020 14:30	10/12/2020 00:30	09/12/2020 14:30	10/12/2020 00:30	9,99	85	848,98	CHI
20201250548	CRISTIANOPOLIS	CF12020367	CRISTIANOPOLIS	09/12/2020 14:30	10/12/2020 00:30	09/12/2020 14:30	10/12/2020 00:30	9,99	7	69,92	CHI
20201249607	GOIANIA	GN11066009	XAVANTES	09/12/2020 14:31	09/12/2020 21:04	09/12/2020 14:31	09/12/2020 21:04	6,55	7	45,85	CHI
20201249611	PORANGATU	PO12390476	MARA ROSA	09/12/2020 14:32	10/12/2020 11:48	09/12/2020 14:32	10/12/2020 11:48	21,26	48	1020,40	CHI
20201249887	QUIRINOPOLIS	QI12226290LD	QUIRINOPOLIS	09/12/2020 14:33	11/12/2020 17:08	09/12/2020 14:33	09/12/2020 20:27	5,90	23	135,75	CHI
20201249887	QUIRINOPOLIS	QI12226290LD	QUIRINOPOLIS	09/12/2020 14:33	11/12/2020 17:08	09/12/2020 14:33	10/12/2020 23:55	33,37	9	300,29	CHI
20201249887	QUIRINOPOLIS	QI12226290LD	QUIRINOPOLIS	09/12/2020 14:33	11/12/2020 17:08	09/12/2020 14:33	11/12/2020 01:14	34,68	43	1491,13	CHI
20201249887	QUIRINOPOLIS	QI12226290LD	QUIRINOPOLIS	09/12/2020 14:33	11/12/2020 17:08	11/12/2020 08:30	11/12/2020 16:57	8,44	23	194,16	CHI
20201249887	QUIRINOPOLIS	QI12226290LD	QUIRINOPOLIS	09/12/2020 14:33	11/12/2020 17:08	09/12/2020 14:33	11/12/2020 17:08	50,59	6	303,52	CHI
20201249887	QUIRINOPOLIS	QI12349552LD	QUIRINOPOLIS	09/12/2020 14:33	11/12/2020 17:08	11/12/2020 08:30	11/12/2020 17:08	8,63	52	448,83	CHI
20201249631	SIMOLANDIA	SA11096290	IACIARA S2	09/12/2020 14:35	09/12/2020 18:56	09/12/2020 14:35	09/12/2020 18:56	4,34	102	442,43	CHI
20201249640	QUIRINOPOLIS	QI11015561	QUIRINOPOLIS	09/12/2020 14:37	09/12/2020 17:40	09/12/2020 14:37	09/12/2020 17:40	3,05	125	381,18	CHI
20201249897	ITUMBIARA	IT12273866	ITUMBIARA VELHA S1	09/12/2020 14:37	11/12/2020 21:40	09/12/2020 14:37	10/12/2020 13:40	23,06	8	184,44	CHI
20201249897	ITUMBIARA	IT12273820LD	ITUMBIARA VELHA S1	09/12/2020 14:37	11/12/2020 21:40	09/12/2020 14:37	11/12/2020 21:40	55,04	1	55,04	CHI
20201249646	AMARALINA	LC12168855	MARA ROSA	09/12/2020 14:38	10/12/2020 09:52	09/12/2020 14:38	10/12/2020 09:52	19,23	35	673,03	CHI
20201249646	MARA ROSA	LC12168855	MARA ROSA	09/12/2020 14:38	10/12/2020 09:52	09/12/2020 14:38	10/12/2020 09:52	19,23	8	153,84	CHI
20201249653	LUZIANIA	10023888766	RIO VERMELHO	09/12/2020 14:38	09/12/2020 18:46	09/12/2020 14:38	09/12/2020 18:46	4,13	1	4,13	CHI
20201249655	JATAI	10010144836	JATAI S2	09/12/2020 14:38	09/12/2020 21:52	09/12/2020 14:38	09/12/2020 21:52	7,22	1	7,22	CHI
20201249657	GOIANIRA	390052966	GOIANIRA	09/12/2020 14:39	10/12/2020 02:51	09/12/2020 14:39	10/12/2020 02:51	12,20	1	12,20	CHI
20201249666	CATALAO	CT12306674RE	CATALAO S1	09/12/2020 14:40	09/12/2020 18:02	09/12/2020 14:40	09/12/2020 18:02	3,36	264	887,33	CHI
20201249668	TRINDADE	10025062580	TRINDADE	09/12/2020 14:40	09/12/2020 15:51	09/12/2020 14:40	09/12/2020 15:51	1,18	1	1,18	CHI
20201249669	ITUMBIARA	690384348	ITUMBIARA VELHA S1	09/12/2020 14:40	09/12/2020 21:27	09/12/2020 14:40	09/12/2020 21:27	6,77	1	6,77	CHI
20201249673	FIRMINOPOLIS	FR21034318	FIRMINOPOLIS S1	09/12/2020 14:40	09/12/2020 16:42	09/12/2020 14:40	09/12/2020 16:42	2,02	1	2,02	CHI
20201250209	GUARANI DE GOIAS	GY11262283	IACIARA S1	09/12/2020 14:40	09/12/2020 20:39	09/12/2020 14:40	09/12/2020 20:39	5,97	124	740,35	CHI
20201251028	QUIRINOPOLIS	QI12296545	QUIRINOPOLIS	09/12/2020 14:40	10/12/2020 05:14	09/12/2020 14:40	10/12/2020 05:14	14,57	2	29,13	CHI
20201251887	SAO JOAO DA PARAUNA	RP12024465	FIRMINOPOLIS S2	09/12/2020 14:40	10/12/2020 12:22	09/12/2020 14:40	10/12/2020 12:22	21,69	5	108,44	CHI
20201249674	CALDAS NOVAS	CN12223516	CALDAS NOVAS S2	09/12/2020 14:41	09/12/2020 17:15	09/12/2020 14:41	09/12/2020 17:15	2,56	594	1520,97	CHI
20201249683	INHUMAS	30127490	INHUMAS S2	09/12/2020 14:43	09/12/2020 17:26	09/12/2020 14:43	09/12/2020 17:26	2,72	1	2,72	CHI
20201249687	VALPARAISO DE GOIAS	VA11110928	MARAJOARA	09/12/2020 14:43	09/12/2020 19:24	09/12/2020 14:43	09/12/2020 19:24	4,67	96	448,32	CHI

20201249690	APORE	AE12202623	ITAJA S2	09/12/2020 14:44	09/12/2020 21:01	09/12/2020 14:44	09/12/2020 21:01	6,28	1	6,28	CHI
20201249693	HIDROLANDIA	1900000237	INDEPENDENCIA S1	09/12/2020 14:44	09/12/2020 16:26	09/12/2020 14:44	09/12/2020 16:26	1,69	1	1,69	CHI
20201249700	SAO SIMAO	SO12322242	CACHOEIRA ALTA	09/12/2020 14:45	09/12/2020 15:13	09/12/2020 14:45	09/12/2020 15:13	0,46	3	1,39	CHI
20201249703	ITABERAI	IB21169327	ITABERAI S1	09/12/2020 14:45	10/12/2020 04:21	09/12/2020 14:45	10/12/2020 04:21	13,59	1	13,59	CHI
20201249704	JARAGUA	JA21029850	JARAGUA	09/12/2020 14:45	10/12/2020 12:11	09/12/2020 14:45	10/12/2020 12:11	21,42	2	42,84	CHI
20201249705	SANTA CRUZ DE GOIAS	10021670070	PIRES DO RIO S2	09/12/2020 14:45	10/12/2020 11:42	09/12/2020 14:45	10/12/2020 11:42	20,94	1	20,94	CHI
20201249710	APARECIDA DE GOIANIA	10019073583	INDEPENDENCIA S1	09/12/2020 14:46	09/12/2020 15:36	09/12/2020 14:46	09/12/2020 15:36	0,83	1	0,83	CHI
20201249735	NOVA ROMA	ND10416743	IACIARA S2	09/12/2020 14:48	12/12/2020 16:34	09/12/2020 14:48	10/12/2020 04:30	13,70	1	13,70	CHI
20201249735	NOVA ROMA	ND10416743	IACIARA S2	09/12/2020 14:48	12/12/2020 16:34	09/12/2020 14:48	10/12/2020 16:21	25,54	1	25,54	CHI
20201249735	SAO DOMINGOS	ND10416743	IACIARA S2	09/12/2020 14:48	12/12/2020 16:34	09/12/2020 14:48	10/12/2020 16:21	25,54	3	76,63	CHI
20201249735	NOVA ROMA	ND10416743	IACIARA S2	09/12/2020 14:48	12/12/2020 16:34	10/12/2020 11:41	10/12/2020 16:21	4,66	1	4,66	CHI
20201249735	NOVA ROMA	ND10416743	IACIARA S2	09/12/2020 14:48	12/12/2020 16:34	09/12/2020 14:48	12/12/2020 16:34	73,76	6	442,58	CHI
20201249735	NOVA ROMA	ND10416743	IACIARA S2	09/12/2020 14:48	12/12/2020 16:34	10/12/2020 16:22	12/12/2020 16:34	48,20	2	96,41	CHI
20201249735	SAO DOMINGOS	ND10416743	IACIARA S2	09/12/2020 14:48	12/12/2020 16:34	10/12/2020 16:22	12/12/2020 16:34	48,20	3	144,61	CHI
20201249738	CIDADE OCIDENTAL	LZ12070110	MARAJOARA	09/12/2020 14:50	09/12/2020 17:42	09/12/2020 14:50	09/12/2020 17:42	2,87	3	8,61	CHI
20201249751	SAO SIMAO	2240058165	CACHOEIRA ALTA	09/12/2020 14:51	09/12/2020 19:51	09/12/2020 14:51	09/12/2020 19:51	4,99	1	4,99	CHI
20201249983	BURITI DE GOIAS	CO12054663	FIRMINOPOLIS S2	09/12/2020 14:51	09/12/2020 18:49	09/12/2020 14:51	09/12/2020 18:49	3,95	10	39,53	CHI
20201249755	ANAPOLIS	20886536	JUNDIAI S2	09/12/2020 14:52	09/12/2020 20:51	09/12/2020 14:52	09/12/2020 20:51	5,99	1	5,99	CHI
20201250351	HIDROLINA	HL12292474	URUACU	09/12/2020 14:52	09/12/2020 19:39	09/12/2020 14:52	09/12/2020 19:39	4,77	7	33,40	CHI
20201250168	MINEIROS	MY12149350RE	PARQUE DAS EMAS	09/12/2020 14:53	10/12/2020 00:48	09/12/2020 14:53	10/12/2020 00:48	9,90	8	79,23	CHI
20201249773	MINACU	10010566269	MINACU	09/12/2020 14:54	09/12/2020 18:14	09/12/2020 14:54	09/12/2020 18:14	3,33	1	3,33	CHI
20201249774	COLINAS DO SUL	9700008611	NIQUELANDIA SUBTRANSMISSAO	09/12/2020 14:54	09/12/2020 20:30	09/12/2020 14:54	09/12/2020 20:30	5,59	1	5,59	CHI
20201249779	PIRES DO RIO	PR21272839	PIRES DO RIO S1	09/12/2020 14:54	10/12/2020 08:35	09/12/2020 14:54	10/12/2020 08:35	17,67	1	17,67	CHI
20201249794	ANAPOLIS	20483922	JUNDIAI S2	09/12/2020 14:57	10/12/2020 15:44	09/12/2020 14:57	10/12/2020 15:44	24,77	1	24,77	CHI
20201249800	APARECIDA DE GOIANIA	11367672	REAL S2	09/12/2020 14:58	09/12/2020 19:28	09/12/2020 14:58	09/12/2020 19:28	4,48	1	4,48	CHI
20201249804	IPORA	730139505	IPORA	09/12/2020 14:59	10/12/2020 02:37	09/12/2020 14:59	10/12/2020 02:37	11,63	1	11,63	CHI
20201249812	QUIRINOPOLIS	QI21418396	QUIRINOPOLIS	09/12/2020 15:00	10/12/2020 11:45	09/12/2020 15:00	10/12/2020 11:45	20,75	1	20,75	CHI
20201249823	AGUA FRIA DE GOIAS	TL12204662	SAO JOAO D ALIANCA	09/12/2020 15:01	09/12/2020 21:15	09/12/2020 15:01	09/12/2020 21:15	6,22	15	93,30	CHI
20201249824	PIRES DO RIO	PR12344710	PIRES DO RIO S1	09/12/2020 15:01	10/12/2020 06:41	09/12/2020 15:01	10/12/2020 06:41	15,65	2	31,30	CHI
20201250751	ALVORADA DO NORTE	AQ12204159	IACIARA S2	09/12/2020 15:01	09/12/2020 22:29	09/12/2020 15:01	09/12/2020 22:29	7,46	24	178,99	CHI
20201249831	LUZIANIA	LZ21000475	RIO VERMELHO	09/12/2020 15:03	09/12/2020 16:40	09/12/2020 15:03	09/12/2020 16:40	1,62	1	1,62	CHI
20201250023	POSSE	PS12132045	IACIARA S2	09/12/2020 15:03	10/12/2020 21:59	09/12/2020 15:03	10/12/2020 11:23	20,34	84	1708,49	CHI
20201250023	POSSE	PS12132045	IACIARA S2	09/12/2020 15:03	10/12/2020 21:59	09/12/2020 15:03	10/12/2020 14:27	23,41	63	1474,62	CHI
20201250023	POSSE	PS12132045	IACIARA S2	09/12/2020 15:03	10/12/2020 21:59	10/12/2020 12:41	10/12/2020 14:27	1,76	84	148,10	CHI
20201250023	POSSE	PS12132045	IACIARA S2	09/12/2020 15:03	10/12/2020 21:59	09/12/2020 15:03	10/12/2020 19:27	28,40	45	1277,96	CHI
20201250023	POSSE	PS12132045	IACIARA S2	09/12/2020 15:03	10/12/2020 21:59	09/12/2020 15:03	10/12/2020 21:59	30,93	10	309,31	CHI
20201249844	GOIANIA	12599876	CAMPINAS S2	09/12/2020 15:04	09/12/2020 18:43	09/12/2020 15:04	09/12/2020 18:43	3,64	1	3,64	CHI
20201249849	JUSSARA	1290084996	JUSSARA	09/12/2020 15:05	09/12/2020 20:51	09/12/2020 15:05	09/12/2020 20:51	5,76	1	5,76	CHI
20201250001	GOIANIA	GN12057362	CARAJAS S1	09/12/2020 15:05	09/12/2020 16:45	09/12/2020 15:05	09/12/2020 16:45	1,66	194	322,85	CHI
20201250150	QUIRINOPOLIS	QI11114716	QUIRINOPOLIS	09/12/2020 15:05	09/12/2020 18:13	09/12/2020 16:44	09/12/2020 18:13	1,48	122	180,97	CHI
20201249851	NOVO BRASIL	NB21064410	MATRINCHA	09/12/2020 15:06	10/12/2020 10:10	09/12/2020 15:06	10/12/2020 10:10	19,07	1	19,07	CHI
20201250235	GUARANI DE GOIAS	GY12393812	IACIARA S1	09/12/2020 15:06	09/12/2020 21:10	09/12/2020 15:06	09/12/2020 21:10	6,06	22	133,41	CHI
20201249865	RIO VERDE	RV21105867	RIO VERDE S1	09/12/2020 15:07	09/12/2020 20:33	09/12/2020 15:07	09/12/2020 20:33	5,42	2	10,84	CHI
20201249866	CRISTALINA	KR21096912	PAMPLONA	09/12/2020 15:08	09/12/2020 22:55	09/12/2020 15:08	09/12/2020 22:55	7,78	1	7,78	CHI
20201249867	ANAPOLIS	20592176	ANAPOLIS UNIVERSITARIO S1	09/12/2020 15:08	09/12/2020 17:10	09/12/2020 15:08	09/12/2020 17:10	2,03	1	2,03	CHI
20201249872	FAINA	FC12396536	GOIAS	09/12/2020 15:09	09/12/2020 19:21	09/12/2020 15:09	09/12/2020 19:21	4,19	3	12,57	CHI
20201249875	CALDAS NOVAS	CN21318995	CALDAS NOVAS S1	09/12/2020 15:10	09/12/2020 18:30	09/12/2020 15:10	09/12/2020 18:30	3,35	1	3,35	CHI
20201249884	NOVA VENEZA	NV21009851	INHUMAS S1	09/12/2020 15:10	09/12/2020 16:08	09/12/2020 15:10	09/12/2020 16:08	0,95	2	1,91	CHI
20201250808	POSSE	PS12255357	IACIARA S2	09/12/2020 15:12	10/12/2020 10:02	09/12/2020 15:12	10/12/2020 10:02	18,82	5	94,11	CHI
20201250382	SAO DOMINGOS	SD12206118	SAO DOMINGOS	09/12/2020 15:13	10/12/2020 09:37	09/12/2020 15:13	10/12/2020 09:37	18,39	9	165,49	CHI
20201249908	SANTA HELENA DE GOIAS	400078200	IPEGUARI	09/12/2020 15:14	10/12/2020 00:08	09/12/2020 15:14	10/12/2020 00:08	8,89	1	8,89	CHI

20201249913	MINEIROS	MY11037697	PARQUE DAS EMAS	09/12/2020 15:15	09/12/2020 21:20	09/12/2020 15:15	09/12/2020 21:20	6,08	153	929,73	CHI
20201249925	GOIANIA	15640632	CAMPINAS S1	09/12/2020 15:18	09/12/2020 16:58	09/12/2020 15:18	09/12/2020 16:58	1,66	1	1,66	CHI
20201249931	AGUAS LINDAS DE GOIAS	10029725826	AGUAS LINDAS DE GOIAS S1	09/12/2020 15:19	09/12/2020 19:01	09/12/2020 15:19	09/12/2020 19:01	3,70	1	3,70	CHI
20201249939	URUTAI	600003322	URUTAI	09/12/2020 15:20	09/12/2020 21:01	09/12/2020 15:20	09/12/2020 21:01	5,68	1	5,68	CHI
20201249941	JATAI	JT21214324	JATAI S2	09/12/2020 15:20	09/12/2020 18:10	09/12/2020 15:20	09/12/2020 18:10	2,82	1	2,82	CHI
20201249942	FLORES DE GOIAS	FB12106993	FLORES DE GOIAS	09/12/2020 15:20	11/12/2020 12:21	09/12/2020 15:20	10/12/2020 16:40	25,32	11	278,51	CHI
20201249942	FORMOSA	FB12106993	FLORES DE GOIAS	09/12/2020 15:20	11/12/2020 12:21	09/12/2020 15:20	10/12/2020 16:40	25,32	4	101,28	CHI
20201249942	FLORES DE GOIAS	FB12106993	FLORES DE GOIAS	09/12/2020 15:20	11/12/2020 12:21	09/12/2020 15:20	11/12/2020 12:21	45,01	3	135,04	CHI
20201249942	FORMOSA	FB12106993	FLORES DE GOIAS	09/12/2020 15:20	11/12/2020 12:21	09/12/2020 15:20	11/12/2020 12:21	45,01	16	720,22	CHI
20201249942	SAO JOAO D ALIANCA	FB12106993	FLORES DE GOIAS	09/12/2020 15:20	11/12/2020 12:21	09/12/2020 15:20	11/12/2020 12:21	45,01	5	225,07	CHI
20201249942	FORMOSA	FB12242937LD	FLORES DE GOIAS	09/12/2020 15:20	11/12/2020 12:21	10/12/2020 12:40	11/12/2020 12:21	23,69	118	2795,91	CHI
20201249942	FORMOSO	FB12242937LD	FLORES DE GOIAS	09/12/2020 15:20	11/12/2020 12:21	10/12/2020 12:40	11/12/2020 12:21	23,69	1	23,69	CHI
20201249945	RIO VERDE	RV12402230	CABRIUVA S2	09/12/2020 15:20	09/12/2020 18:51	09/12/2020 15:20	09/12/2020 18:51	3,50	3	10,50	CHI
20201249945	APARECIDA DO RIO DOCE	RV12402230	CABRIUVA S2	09/12/2020 15:20	09/12/2020 18:51	09/12/2020 15:20	09/12/2020 18:51	3,50	6	21,00	CHI
20201249948	GOIANIA	10002415753	GOYA S1	09/12/2020 15:21	09/12/2020 19:18	09/12/2020 15:21	09/12/2020 19:18	3,95	1	3,95	CHI
20201251180	MINACU	IH16407760	MINACU	09/12/2020 15:21	10/12/2020 02:52	09/12/2020 15:21	09/12/2020 21:04	5,71	3150	17985,63	CHI
20201251180	MINACU	IH16407760	MINACU	09/12/2020 15:21	10/12/2020 02:52	09/12/2020 20:49	09/12/2020 21:04	0,23	437	102,57	CHI
20201251180	MINACU	IH16431825	MINACU	09/12/2020 15:21	10/12/2020 02:52	09/12/2020 22:04	10/12/2020 02:44	4,67	1157	5398,37	CHI
20201251180	MINACU	IH13088793	MINACU	09/12/2020 15:21	10/12/2020 02:52	09/12/2020 15:21	10/12/2020 02:52	11,52	231	2661,12	CHI
20201250134	TAQUARAL DE GOIAS	TQ12299642	INHUMAS S1	09/12/2020 15:22	10/12/2020 09:25	09/12/2020 15:22	10/12/2020 09:25	18,05	12	216,54	CHI
20201249962	PLANALTINA	PI12302894	PLANALTINA	09/12/2020 15:23	09/12/2020 19:46	09/12/2020 15:23	09/12/2020 19:46	4,38	1	4,38	CHI
20201249972	LUZIANIA	LZ21183878	MARAJOARA	09/12/2020 15:24	09/12/2020 16:30	09/12/2020 15:24	09/12/2020 16:30	1,08	1	1,08	CHI
20201250089	FLORES DE GOIAS	FB12255011	FLORES DE GOIAS	09/12/2020 15:24	09/12/2020 17:10	09/12/2020 15:24	09/12/2020 17:10	1,76	402	708,41	CHI
20201250089	NOVA ROMA	FB12255011	FLORES DE GOIAS	09/12/2020 15:24	09/12/2020 17:10	09/12/2020 15:24	09/12/2020 17:10	1,76	2	3,52	CHI
20201250089	SAO JOAO D ALIANCA	FB12255011	FLORES DE GOIAS	09/12/2020 15:24	09/12/2020 17:10	09/12/2020 15:24	09/12/2020 17:10	1,76	46	81,06	CHI
20201249979	GOIATUBA	GT21000212	BOM JESUS DE GOIAS	09/12/2020 15:25	09/12/2020 17:55	09/12/2020 15:25	09/12/2020 17:55	2,49	1	2,49	CHI
20201249991	CRISTALINA	KR21236300	CRISTALINA S1	09/12/2020 15:26	10/12/2020 13:23	09/12/2020 15:26	10/12/2020 13:23	21,95	1	21,95	CHI
20201249998	GOIANIRA	10007323873	GOIANIRA	09/12/2020 15:27	09/12/2020 21:08	09/12/2020 15:27	09/12/2020 21:08	5,68	1	5,68	CHI
20201250009	CAMPOS BELOS	10000364000	SAO DOMINGOS	09/12/2020 15:28	09/12/2020 18:07	09/12/2020 15:28	09/12/2020 18:07	2,65	1	2,65	CHI
20201250276	JUSSARA	RN12259833	BRITANIA	09/12/2020 15:28	09/12/2020 22:43	09/12/2020 15:28	09/12/2020 22:43	7,24	6	43,47	CHI
20201250276	SANTA FE DE GOIAS	RN12259833	BRITANIA	09/12/2020 15:28	09/12/2020 22:43	09/12/2020 15:28	09/12/2020 22:43	7,24	4	28,98	CHI
20201250015	GOIANIA	12176485	GOYA S2	09/12/2020 15:29	09/12/2020 20:19	09/12/2020 15:29	09/12/2020 20:19	4,83	1	4,83	CHI
20201250017	GOIANIA	10970630	FERROVIARIO S3	09/12/2020 15:29	09/12/2020 20:15	09/12/2020 15:29	09/12/2020 20:15	4,76	1	4,76	CHI
20201250019	URUACU	640103960	URUACU	09/12/2020 15:29	09/12/2020 19:58	09/12/2020 15:29	09/12/2020 19:58	4,48	1	4,48	CHI
20201250020	CRISTALINA	KR12230276	CRISTALINA S2	09/12/2020 15:29	10/12/2020 08:03	09/12/2020 15:29	10/12/2020 08:03	16,56	14	231,80	CHI
20201250918	GOIATUBA	GT21257124	VICENTINOPOLIS	09/12/2020 15:29	09/12/2020 20:25	09/12/2020 15:29	09/12/2020 20:25	4,93	2	9,86	CHI
20201250027	BELA VISTA DE GOIAS	BV21323698	BELA VISTA S1	09/12/2020 15:30	09/12/2020 16:27	09/12/2020 15:30	09/12/2020 16:27	0,95	2	1,89	CHI
20201250031	SAO LUIS DE MONTES BELOS	SL21283997	SAO LUIZ DOS MONTES BELOS	09/12/2020 15:30	10/12/2020 01:32	09/12/2020 15:30	10/12/2020 01:32	10,02	2	20,04	CHI
20201250040	GOIANIA	13065166	REAL S2	09/12/2020 15:31	09/12/2020 17:52	09/12/2020 15:31	09/12/2020 17:52	2,33	1	2,33	CHI
202012133915	CAMPOS VERDES	VD11037451	SANTA TEREZINHA	09/12/2020 15:32	10/12/2020 16:07	09/12/2020 22:36	10/12/2020 04:10	5,56	65	361,60	CHI
202012133915	CAMPOS VERDES	VD11049792	SANTA TEREZINHA	09/12/2020 15:32	10/12/2020 16:07	10/12/2020 00:53	10/12/2020 04:10	3,29	136	447,67	CHI
202012133915	CAMPOS VERDES	VD12201664	SANTA TEREZINHA	09/12/2020 15:32	10/12/2020 16:07	09/12/2020 22:36	10/12/2020 15:25	16,82	1	16,82	CHI
202012133915	CAMPOS VERDES	VD12201664	SANTA TEREZINHA	09/12/2020 15:32	10/12/2020 16:07	09/12/2020 22:36	10/12/2020 16:07	17,51	44	770,48	CHI
20201250052	APARECIDA DE GOIANIA	200280855	INDEPENDENCIA S1	09/12/2020 15:33	09/12/2020 17:06	09/12/2020 15:33	09/12/2020 17:06	1,54	1	1,54	CHI
20201250070	GOIANIA	13967733	CAMPINAS S2	09/12/2020 15:36	09/12/2020 20:36	09/12/2020 15:36	09/12/2020 20:36	5,00	1	5,00	CHI
20201250074	ITUMBIARA	690290822	ITUMBIARA VELHA S1	09/12/2020 15:36	10/12/2020 12:16	09/12/2020 15:36	10/12/2020 12:16	20,65	1	20,65	CHI
20201250224	GOIANIA	GN11247982	CARAJAS S2	09/12/2020 15:36	09/12/2020 16:45	09/12/2020 15:36	09/12/2020 16:45	1,13	87	98,74	CHI
20201250085	GOIANIA	10005231963	GOYA S1	09/12/2020 15:37	09/12/2020 19:57	09/12/2020 15:37	09/12/2020 19:57	4,33	1	4,33	CHI
20201250092	JATAI	290317861	JATAI S3	09/12/2020 15:38	10/12/2020 07:56	09/12/2020 15:38	10/12/2020 07:56	16,31	1	16,31	CHI
20201250095	GUAPO	710014788	GUAPO S1	09/12/2020 15:38	10/12/2020 01:37	09/12/2020 15:38	10/12/2020 01:37	9,98	1	9,98	CHI
20201251785	FLORES DE GOIAS	FB12390645	IACIARA S2	09/12/2020 15:39	09/12/2020 21:23	09/12/2020 15:39	09/12/2020 21:23	5,73	171	979,78	CHI

20201251785	VILA BOA	FB12390645	IACIARA S2	09/12/2020 15:39	09/12/2020 21:23	09/12/2020 15:39	09/12/2020 21:23	5,73	3	17,19	CHI
20201251785	FORMOSA	FB12390645	IACIARA S2	09/12/2020 15:39	09/12/2020 21:23	09/12/2020 15:39	09/12/2020 21:23	5,73	1	5,73	CHI
20201250108	JARAGUA	10000299861	JARAGUA	09/12/2020 15:40	10/12/2020 11:07	09/12/2020 15:40	10/12/2020 11:07	19,45	1	19,45	CHI
20201250110	AMORINOPOLIS	AM21000022	IPORA	09/12/2020 15:40	09/12/2020 16:23	09/12/2020 15:40	09/12/2020 16:23	0,71	1	0,71	CHI
20201250119	VIANOPOLIS	VN21079975	VIANOPOLIS	09/12/2020 15:41	10/12/2020 11:07	09/12/2020 15:41	10/12/2020 11:07	19,43	1	19,43	CHI
20201250121	JAUPACI	JP21121385	IPORA	09/12/2020 15:41	10/12/2020 08:51	09/12/2020 15:41	10/12/2020 08:51	17,15	1	17,15	CHI
20201250125	NOVA CRIXAS	NA21349195	NOVA CRIXAS	09/12/2020 15:42	09/12/2020 16:04	09/12/2020 15:42	09/12/2020 16:04	0,36	1	0,36	CHI
20201250126	GOIANIA	14498819	GOYA S2	09/12/2020 15:42	10/12/2020 04:30	09/12/2020 15:42	10/12/2020 04:30	12,79	1	12,79	CHI
20201250132	CIDADE OCIDENTAL	19782163	MARAJOARA	09/12/2020 15:43	09/12/2020 19:04	09/12/2020 15:43	09/12/2020 19:04	3,35	6	20,09	CHI
20201250148	SENADOR CANEDO	SW12393265	SENADOR CANEDO	09/12/2020 15:43	09/12/2020 19:58	09/12/2020 15:43	09/12/2020 19:58	4,24	440	1867,07	CHI
20201250855	IPAMERI	CM13376045	CAMPO ALEGRE DE GOIAS	09/12/2020 15:43	11/12/2020 13:14	09/12/2020 15:43	11/12/2020 13:14	45,52	1	45,52	CHI
20201250855	CAMPO ALEGRE DE GOIAS	CM13376045	CAMPO ALEGRE DE GOIAS	09/12/2020 15:43	11/12/2020 13:14	09/12/2020 15:43	11/12/2020 13:14	45,52	14	637,23	CHI
20201250855	IPAMERI	CM13376045	CAMPO ALEGRE DE GOIAS	09/12/2020 15:43	11/12/2020 13:14	11/12/2020 10:03	11/12/2020 13:14	3,17	10	31,69	CHI
20201250855	CAMPO ALEGRE DE GOIAS	CM13376045	CAMPO ALEGRE DE GOIAS	09/12/2020 15:43	11/12/2020 13:14	11/12/2020 10:03	11/12/2020 13:14	3,17	37	117,27	CHI
20201250855	CATALAO	CM13376045	CAMPO ALEGRE DE GOIAS	09/12/2020 15:43	11/12/2020 13:14	11/12/2020 10:03	11/12/2020 13:14	3,17	3	9,51	CHI
20201252209	CORREGO DO OURO	CO21054658	SAO LUIZ DOS MONTES BELOS	09/12/2020 15:43	10/12/2020 09:45	09/12/2020 15:43	10/12/2020 09:45	18,03	2	36,05	CHI
20201250141	MINEIROS	MY21194496	PARQUE DAS EMAS	09/12/2020 15:45	10/12/2020 11:50	09/12/2020 15:45	10/12/2020 11:50	20,10	1	20,10	CHI
20201250475	MINACU	IH12129795	MINACU	09/12/2020 15:45	10/12/2020 04:19	09/12/2020 15:45	10/12/2020 04:19	12,56	36	452,25	CHI
20201250160	ITUMBIARA	BJ21316788	CACHOEIRA DOURADA	09/12/2020 15:47	10/12/2020 01:21	09/12/2020 15:47	10/12/2020 01:21	9,55	1	9,55	CHI
20201250161	FORMOSA	10030128577	ITUIQUIRA	09/12/2020 15:47	09/12/2020 17:59	09/12/2020 15:47	09/12/2020 17:59	2,19	1	2,19	CHI
20201250260	CRISTALINA	KR10406854	CRISTALINA S2	09/12/2020 15:47	09/12/2020 23:55	09/12/2020 16:04	09/12/2020 18:01	1,94	45	87,35	CHI
20201250260	CRISTALINA	KR10406854	CRISTALINA S2	09/12/2020 15:47	09/12/2020 23:55	09/12/2020 16:04	09/12/2020 19:06	3,03	185	561,01	CHI
20201250260	CRISTALINA	KR10406671	CRISTALINA S2	09/12/2020 15:47	09/12/2020 23:55	09/12/2020 15:47	09/12/2020 19:45	3,96	263	1040,90	CHI
20201250260	CRISTALINA	KR10406854	CRISTALINA S2	09/12/2020 15:47	09/12/2020 23:55	09/12/2020 16:04	09/12/2020 21:22	5,30	92	487,27	CHI
20201250260	CRISTALINA	KR12276436LD	CRISTALINA S2	09/12/2020 15:47	09/12/2020 23:55	09/12/2020 16:04	09/12/2020 23:55	7,85	3	23,54	CHI
20201252111	AGUA FRIA DE GOIAS	TL12394158	SAO JOAO D ALIANCA	09/12/2020 15:47	09/12/2020 23:34	09/12/2020 15:47	09/12/2020 23:34	7,78	16	124,42	CHI
20201250163	SANTO ANTONIO DO DESCOBERTO	SN21078101	MARAJOARA	09/12/2020 15:48	09/12/2020 20:23	09/12/2020 15:48	09/12/2020 20:23	4,58	2	9,16	CHI
20201250164	ALEXANIA	AX12196986	ALEXANIA	09/12/2020 15:48	09/12/2020 20:43	09/12/2020 15:48	09/12/2020 20:43	4,91	1	4,91	CHI
20201250172	FAZENDA NOVA	1080006117	JUSSARA	09/12/2020 15:50	10/12/2020 10:54	09/12/2020 15:50	10/12/2020 10:54	19,07	1	19,07	CHI
20201250451	SILVANIA	SV12205354	DAIA S2	09/12/2020 15:50	09/12/2020 19:15	09/12/2020 15:50	09/12/2020 19:15	3,41	40	136,26	CHI
20201250878	LUZIANIA	LZ12351425	RIO VERMELHO	09/12/2020 15:51	09/12/2020 20:25	09/12/2020 15:51	09/12/2020 20:25	4,56	74	337,17	CHI
20201250193	NOVA ROMA	8720005467	IACIARA S2	09/12/2020 15:52	10/12/2020 10:28	09/12/2020 15:52	10/12/2020 10:28	18,60	1	18,60	CHI
20201250333	BALIZA	BH10406688	BOM JARDIM	09/12/2020 15:52	09/12/2020 19:32	09/12/2020 15:52	09/12/2020 19:32	3,66	53	193,80	CHI
20201248924	LUZIANIA	LZ10404047	MARAJOARA	09/12/2020 15:54	11/12/2020 20:45	09/12/2020 15:54	10/12/2020 08:41	16,78	447	7501,65	CHI
20201248924	LUZIANIA	LZ13348555	MARAJOARA	09/12/2020 15:54	11/12/2020 20:45	10/12/2020 08:14	10/12/2020 08:41	0,45	1	0,45	CHI
20201248924	LUZIANIA	LZ13376283	MARAJOARA	09/12/2020 15:54	11/12/2020 20:45	10/12/2020 09:30	10/12/2020 11:44	2,23	78	174,03	CHI
20201248924	LUZIANIA	LZ12330783RE	MARAJOARA	09/12/2020 15:54	11/12/2020 20:45	10/12/2020 09:30	10/12/2020 13:26	3,94	50	196,93	CHI
20201248924	LUZIANIA	LZ12349111	MARAJOARA	09/12/2020 15:54	11/12/2020 20:45	10/12/2020 09:30	10/12/2020 15:22	5,88	47	276,33	CHI
20201248924	LUZIANIA	LZ13330479	MARAJOARA	09/12/2020 15:54	11/12/2020 20:45	10/12/2020 09:30	10/12/2020 16:45	7,26	117	849,00	CHI
20201248924	LUZIANIA	LZ10404047	MARAJOARA	09/12/2020 15:54	11/12/2020 20:45	10/12/2020 09:30	10/12/2020 16:59	7,49	1	7,49	CHI
20201248924	LUZIANIA	LZ10404047	MARAJOARA	09/12/2020 15:54	11/12/2020 20:45	10/12/2020 16:46	10/12/2020 16:59	0,21	346	72,76	CHI
20201248924	LUZIANIA	LZ10404047	MARAJOARA	09/12/2020 15:54	11/12/2020 20:45	10/12/2020 19:10	10/12/2020 21:00	1,83	274	501,95	CHI
20201248924	LUZIANIA	LZ12283904RE	MARAJOARA	09/12/2020 15:54	11/12/2020 20:45	10/12/2020 19:10	10/12/2020 22:22	3,19	17	54,23	CHI
20201248924	LUZIANIA	LZ13090043	MARAJOARA	09/12/2020 15:54	11/12/2020 20:45	10/12/2020 19:18	11/12/2020 03:30	8,20	4	32,79	CHI
20201248924	NOVO GAMA	LZ13090043	MARAJOARA	09/12/2020 15:54	11/12/2020 20:45	10/12/2020 19:18	11/12/2020 03:30	8,20	2	16,40	CHI
20201248924	NOVO GAMA	00060434	MARAJOARA	09/12/2020 15:54	11/12/2020 20:45	10/12/2020 20:44	11/12/2020 03:30	6,76	1	6,76	CHI
20201248924	LUZIANIA	00060434	MARAJOARA	09/12/2020 15:54	11/12/2020 20:45	11/12/2020 05:01	11/12/2020 05:31	0,50	4	2,02	CHI
20201248924	NOVO GAMA	00060434	MARAJOARA	09/12/2020 15:54	11/12/2020 20:45	11/12/2020 05:01	11/12/2020 05:31	0,50	3	1,51	CHI
20201248924	LUZIANIA	00060434	MARAJOARA	09/12/2020 15:54	11/12/2020 20:45	11/12/2020 09:55	11/12/2020 10:11	0,27	4	1,07	CHI
20201248924	NOVO GAMA	00060434	MARAJOARA	09/12/2020 15:54	11/12/2020 20:45	11/12/2020 09:55	11/12/2020 10:11	0,27	3	0,80	CHI
20201248924	LUZIANIA	LZ13330479	MARAJOARA	09/12/2020 15:54	11/12/2020 20:45	10/12/2020 16:46	11/12/2020 11:39	18,88	50	944,01	CHI

20201248924	LUZIANIA	LZ12304863	MARAJOARA	09/12/2020 15:54	11/12/2020 20:45	10/12/2020 16:46	11/12/2020 14:07	21,33	35	746,70	CHI
20201248924	LUZIANIA	LZ13090043	MARAJOARA	09/12/2020 15:54	11/12/2020 20:45	10/12/2020 19:18	11/12/2020 14:34	19,27	2	38,54	CHI
20201248924	LUZIANIA	LZ13090043	MARAJOARA	09/12/2020 15:54	11/12/2020 20:45	10/12/2020 19:18	11/12/2020 15:19	20,02	3	60,06	CHI
20201248924	LUZIANIA	LZ13090045	MARAJOARA	09/12/2020 15:54	11/12/2020 20:45	10/12/2020 22:53	11/12/2020 15:19	16,43	14	230,04	CHI
20201248924	LUZIANIA	LZ12396834LD	MARAJOARA	09/12/2020 15:54	11/12/2020 20:45	10/12/2020 16:46	11/12/2020 15:41	22,90	20	458,08	CHI
20201248924	LUZIANIA	LZ12290519LD	MARAJOARA	09/12/2020 15:54	11/12/2020 20:45	10/12/2020 16:46	11/12/2020 16:26	23,65	12	283,85	CHI
20201248924	LUZIANIA	LZ12396830	MARAJOARA	09/12/2020 15:54	11/12/2020 20:45	10/12/2020 19:10	11/12/2020 20:45	25,57	56	1432,04	CHI
20201251991	FLORES DE GOIAS	FB12218636	IACIARA S2	09/12/2020 15:55	09/12/2020 22:52	09/12/2020 15:55	09/12/2020 22:52	6,94	3	20,82	CHI
20201251258	QUIRINOPOLIS	QI32255692	QUIRINOPOLIS	09/12/2020 15:56	10/12/2020 02:20	09/12/2020 15:56	10/12/2020 02:20	10,40	9	93,58	CHI
20201250234	SAO JOAO D ALIANCA	JL12146226	SAO JOAO D ALIANCA	09/12/2020 15:57	10/12/2020 14:40	09/12/2020 15:57	10/12/2020 14:40	22,71	71	1612,55	CHI
20201250237	ITAJA	IJ12200626	ITAJA S2	09/12/2020 15:57	09/12/2020 20:27	09/12/2020 15:57	09/12/2020 20:27	4,49	7	31,45	CHI
20201250377	SENADOR CANEDO	SW12392762	SENADOR CANEDO	09/12/2020 15:57	09/12/2020 17:07	09/12/2020 15:57	09/12/2020 17:07	1,16	664	769,87	CHI
20201250244	OURO VERDE DE GOIAS	370602961	NEROPOLIS S1	09/12/2020 15:58	10/12/2020 10:00	09/12/2020 15:58	10/12/2020 10:00	18,04	1	18,04	CHI
20201250245	GOIANIA	10010370097	GOYA S1	09/12/2020 15:58	09/12/2020 17:57	09/12/2020 15:58	09/12/2020 17:57	1,98	1	1,98	CHI
20201250246	LUZIANIA	LZ21000220	RIO VERMELHO	09/12/2020 15:58	09/12/2020 22:54	09/12/2020 15:58	09/12/2020 22:54	6,93	1	6,93	CHI
20201250436	SANTA ROSA DE GOIAS	SR12079786	INHUMAS S1	09/12/2020 15:58	09/12/2020 23:12	09/12/2020 15:58	09/12/2020 23:12	7,22	7	50,53	CHI
20201250696	NOVA ROMA	ND12392238	IACIARA S2	09/12/2020 15:58	10/12/2020 00:37	09/12/2020 15:58	10/12/2020 00:37	8,65	235	2032,75	CHI
20201250251	ANAPOLIS	10018676934	ANAPOLIS UNIVERSITARIO S2	09/12/2020 15:59	10/12/2020 00:02	09/12/2020 15:59	10/12/2020 00:02	8,06	1	8,06	CHI
20201250257	APARECIDA DE GOIANIA	11962069	REAL S2	09/12/2020 15:59	09/12/2020 18:21	09/12/2020 15:59	09/12/2020 18:21	2,35	1	2,35	CHI
20201250268	DAMOLANDIA	270009929	INHUMAS S1	09/12/2020 16:00	10/12/2020 02:15	09/12/2020 16:00	10/12/2020 02:15	10,24	1	10,24	CHI
20201250274	QUIRINOPOLIS	DM12153969	RIO DOS BOIS	09/12/2020 16:00	10/12/2020 02:04	09/12/2020 16:00	10/12/2020 02:04	10,06	9	90,56	CHI
20201250274	CASTELANDIA	DM12153969	RIO DOS BOIS	09/12/2020 16:00	10/12/2020 02:04	09/12/2020 16:00	10/12/2020 02:04	10,06	6	60,37	CHI
20201250274	BOM JESUS DE GOIAS	DM12153969	RIO DOS BOIS	09/12/2020 16:00	10/12/2020 02:04	09/12/2020 16:00	10/12/2020 02:04	10,06	1	10,06	CHI
20201250796	PLANALTINA	PI12302898	PLANALTINA	09/12/2020 16:03	09/12/2020 21:12	09/12/2020 16:03	09/12/2020 21:12	5,15	70	360,27	CHI
20201251161	GOIANIA	GN11000854	FERROVIARIO S1	09/12/2020 16:03	09/12/2020 20:10	09/12/2020 16:03	09/12/2020 20:10	4,11	128	526,72	CHI
20201251766	MUTUNOPOLIS	MU11287993	MARA ROSA	09/12/2020 16:04	09/12/2020 22:06	09/12/2020 16:04	09/12/2020 22:06	6,03	89	536,42	CHI
20201250300	APARECIDA DO RIO DOCE	AW21122544	JATAI S1	09/12/2020 16:05	11/12/2020 08:29	09/12/2020 16:05	11/12/2020 08:29	40,39	1	40,39	CHI
20201250330	ANAPOLIS	AN12217419	ANAPOLIS UNIVERSITARIO S2	09/12/2020 16:09	09/12/2020 20:58	09/12/2020 16:09	09/12/2020 20:58	4,81	12	57,73	CHI
20201250335	ITUMBIARA	BG12263567	ITUMBIARA VELHA S2	09/12/2020 16:10	09/12/2020 23:12	09/12/2020 16:10	09/12/2020 23:12	7,03	16	112,47	CHI
20201250335	BURITI ALEGRE	BG12263567	ITUMBIARA VELHA S2	09/12/2020 16:10	09/12/2020 23:12	09/12/2020 16:10	09/12/2020 23:12	7,03	4	28,12	CHI
20201250339	RIO VERDE	630092424	RIO VERDE S2	09/12/2020 16:10	09/12/2020 22:10	09/12/2020 16:10	09/12/2020 22:10	5,99	1	5,99	CHI
20201251050	PALMEIRAS DE GOIAS	PL12308514	PALMEIRAS	09/12/2020 16:11	09/12/2020 19:16	09/12/2020 16:11	09/12/2020 19:16	3,08	3	9,23	CHI
202012179369	PONTALINA	PK21346389	PONTALINA	09/12/2020 16:11	10/12/2020 08:46	09/12/2020 16:11	10/12/2020 08:46	16,58	1	16,58	CHI
20201250352	FAINA	FC12299836	GOIAS	09/12/2020 16:12	10/12/2020 11:16	09/12/2020 16:12	10/12/2020 11:16	19,05	2	38,11	CHI
20201250360	ORIZONA	OZ11202892	PIRES DO RIO S2	09/12/2020 16:13	09/12/2020 23:27	09/12/2020 16:13	09/12/2020 23:27	7,22	135	974,70	CHI
20201250369	GOIANIA	12088572	GOYA S1	09/12/2020 16:14	09/12/2020 19:16	09/12/2020 16:14	09/12/2020 19:16	3,02	1	3,02	CHI
20201250507	MINEIROS	MY12114029	PARQUE DAS EMAS	09/12/2020 16:14	09/12/2020 17:37	09/12/2020 16:14	09/12/2020 17:37	1,37	7	9,58	CHI
20201251246	NIQUELANDIA	NQ12248223	URUACU	09/12/2020 16:15	12/12/2020 12:48	09/12/2020 16:15	12/12/2020 12:33	68,30	7	478,10	CHI
20201251246	NIQUELANDIA	NQ12248223	URUACU	09/12/2020 16:15	12/12/2020 12:48	09/12/2020 16:15	12/12/2020 12:48	68,56	2	137,11	CHI
20201250378	CACHOEIRA DOURADA	CD12222373	CACHOEIRA DOURADA	09/12/2020 16:16	10/12/2020 17:36	09/12/2020 16:16	10/12/2020 17:36	25,32	2	50,65	CHI
20201250379	GOIANIA	16982289	XAVANTES	09/12/2020 16:17	09/12/2020 22:33	09/12/2020 16:17	09/12/2020 22:33	6,26	1	6,26	CHI
20201251031	ANAPOLIS	AN12211783	ANAPOLIS UNIVERSITARIO S2	09/12/2020 16:17	09/12/2020 20:29	09/12/2020 16:17	09/12/2020 20:29	4,19	234	980,14	CHI
20201250394	SAO JOAO D ALIANCA	JL12144641	SAO JOAO D ALIANCA	09/12/2020 16:19	10/12/2020 09:18	09/12/2020 16:19	10/12/2020 09:18	16,98	5	84,89	CHI
20201250397	CATALAO	CT21192632	CATALAO S2	09/12/2020 16:19	10/12/2020 08:50	09/12/2020 16:19	10/12/2020 08:50	16,50	1	16,50	CHI
20201250398	NOVA IGUACU DE GOIAS	NH21181594	CAMPINORTE	09/12/2020 16:19	10/12/2020 03:29	09/12/2020 16:19	10/12/2020 03:29	11,15	1	11,15	CHI
20201252009	CAMPOS VERDES	VD12201660RE	SANTA TEREZINHA	09/12/2020 16:19	10/12/2020 07:53	09/12/2020 16:19	10/12/2020 07:53	15,56	21	326,75	CHI
20201252009	SANTA TEREZINHA DE GOIAS	VD12201660RE	SANTA TEREZINHA	09/12/2020 16:19	10/12/2020 07:53	09/12/2020 16:19	10/12/2020 07:53	15,56	47	731,29	CHI
20201250400	GOIANIA	10014469225	AEROPORTO S2	09/12/2020 16:20	09/12/2020 19:50	09/12/2020 16:20	09/12/2020 19:50	3,50	1	3,50	CHI
20201250403	PILAR DE GOIAS	HL21293497	SANTA TEREZINHA	09/12/2020 16:20	09/12/2020 18:52	09/12/2020 16:20	09/12/2020 18:52	2,53	1	2,53	CHI
20201251045	CAMPESTRE DE GOIAS	GC12000124	TRINDADE	09/12/2020 16:20	09/12/2020 22:11	09/12/2020 16:20	09/12/2020 22:11	5,85	16	93,57	CHI
20201251083	SANTA RITA DO NOVO DESTINO	DF12382137	BARRO ALTO	09/12/2020 16:20	10/12/2020 00:58	09/12/2020 16:20	10/12/2020 00:58	8,63	12	103,57	CHI

20201250888	MINEIROS	MY12303867	PARQUE DAS EMAS	09/12/2020 16:21	09/12/2020 17:48	09/12/2020 16:21	09/12/2020 17:48	1,44	8	11,50	CHI
20201250415	SANTA TEREZINHA DE GOIAS	SG12237497	SANTA TEREZINHA	09/12/2020 16:22	09/12/2020 21:00	09/12/2020 16:22	09/12/2020 21:00	4,63	4	18,51	CHI
20201250418	ITAPACI	IW12338559	RUBIATABA	09/12/2020 16:22	09/12/2020 21:12	09/12/2020 16:22	09/12/2020 21:12	4,82	1	4,82	CHI
20201250560	NOVA ROMA	ND12394116	IACIARA S2	09/12/2020 16:22	10/12/2020 16:47	09/12/2020 16:22	10/12/2020 16:47	24,41	5	122,04	CHI
20201250560	SAO JOAO D ALIANCA	ND12394116	IACIARA S2	09/12/2020 16:22	10/12/2020 16:47	09/12/2020 16:22	10/12/2020 16:47	24,41	15	366,11	CHI
20201250421	ARAGOIANA	AO21360342	GUAPO S2	09/12/2020 16:23	09/12/2020 17:40	09/12/2020 16:23	09/12/2020 17:40	1,28	1	1,28	CHI
20201250424	SAO FRANCISCO DE GOIAS	SF21000143	SAO FRANCISCO DE GOIAS	09/12/2020 16:23	10/12/2020 10:45	09/12/2020 16:23	10/12/2020 10:45	18,36	1	18,36	CHI
20201250433	SAO MIGUEL DO ARAGUAIA	SM21263050	SAO MIGUEL DO ARAGUAIA	09/12/2020 16:24	09/12/2020 22:08	09/12/2020 16:24	09/12/2020 22:08	5,72	1	5,72	CHI
20201250457	SAO MIGUEL DO ARAGUAIA	SM21000024	SAO MIGUEL DO ARAGUAIA	09/12/2020 16:27	10/12/2020 01:52	09/12/2020 16:27	10/12/2020 01:52	9,40	1	9,40	CHI
20201250466	CAIAPONIA	CP11355609	PALESTINA	09/12/2020 16:28	10/12/2020 11:57	09/12/2020 16:28	10/12/2020 11:57	19,48	1	19,48	CHI
20201250478	IACIARA	GY12257673	IACIARA S1	09/12/2020 16:28	10/12/2020 21:59	09/12/2020 16:28	10/12/2020 13:01	20,54	1	20,54	CHI
20201250478	GUARANI DE GOIAS	GY12257673	IACIARA S1	09/12/2020 16:28	10/12/2020 21:59	09/12/2020 16:28	10/12/2020 13:01	20,54	20	410,74	CHI
20201250478	GUARANI DE GOIAS	GY12257673	IACIARA S1	09/12/2020 16:28	10/12/2020 21:59	09/12/2020 16:28	10/12/2020 15:30	23,02	55	1265,96	CHI
20201250478	IACIARA	GY12257673	IACIARA S1	09/12/2020 16:28	10/12/2020 21:59	09/12/2020 16:28	10/12/2020 15:30	23,02	5	115,09	CHI
20201250478	GUARANI DE GOIAS	GY12255285LD	IACIARA S1	09/12/2020 16:28	10/12/2020 21:59	09/12/2020 21:55	10/12/2020 15:30	17,58	11	193,42	CHI
20201250478	IACIARA	GY12255285LD	IACIARA S1	09/12/2020 16:28	10/12/2020 21:59	10/12/2020 15:49	10/12/2020 16:04	0,24	5	1,21	CHI
20201250478	GUARANI DE GOIAS	GY12255285LD	IACIARA S1	09/12/2020 16:28	10/12/2020 21:59	10/12/2020 15:49	10/12/2020 16:04	0,24	66	15,95	CHI
20201250478	GUARANI DE GOIAS	GY12257673	IACIARA S1	09/12/2020 16:28	10/12/2020 21:59	09/12/2020 16:28	10/12/2020 21:26	28,97	3	86,90	CHI
20201250478	GUARANI DE GOIAS	GY12257673	IACIARA S1	09/12/2020 16:28	10/12/2020 21:59	09/12/2020 16:28	10/12/2020 21:59	29,51	7	206,55	CHI
20201250471	GOIAS	GS21054634	GOIAS	09/12/2020 16:29	10/12/2020 10:18	09/12/2020 16:29	10/12/2020 10:18	17,81	1	17,81	CHI
20201250473	TURVANIA	10006199354	FIRMINOPOLIS S2	09/12/2020 16:29	10/12/2020 09:55	09/12/2020 16:29	10/12/2020 09:55	17,43	1	17,43	CHI
20201250477	RIO VERDE	630263735	CABRIUVA S1	09/12/2020 16:29	09/12/2020 21:00	09/12/2020 16:29	09/12/2020 21:00	4,50	1	4,50	CHI
20201250479	PORTEIRAO	CL12295947	RIO DOS BOIS	09/12/2020 16:30	09/12/2020 17:05	09/12/2020 16:30	09/12/2020 17:05	0,58	5	2,92	CHI
20201250490	FAINA	FC21029560	GOIAS	09/12/2020 16:31	09/12/2020 18:33	09/12/2020 16:31	09/12/2020 18:33	2,02	1	2,02	CHI
20201250508	SAO MIGUEL DO ARAGUAIA	SM21322596	SAO MIGUEL DO ARAGUAIA	09/12/2020 16:33	10/12/2020 17:02	09/12/2020 16:33	10/12/2020 17:02	24,48	1	24,48	CHI
20201250510	BURITINOPOLIS	MB12314303	IACIARA S2	09/12/2020 16:33	09/12/2020 18:07	09/12/2020 16:33	09/12/2020 18:07	1,56	2	3,12	CHI
20201250510	MAMBAI	MB12314303	IACIARA S2	09/12/2020 16:33	09/12/2020 18:07	09/12/2020 16:33	09/12/2020 18:07	1,56	4	6,23	CHI
20201250520	TERESINA DE GOIAS	TE21218389	FLORES DE GOIAS	09/12/2020 16:34	09/12/2020 20:36	09/12/2020 16:34	09/12/2020 20:36	4,02	1	4,02	CHI
20201250522	PILAR DE GOIAS	10022714411	SANTA TEREZINHA	09/12/2020 16:34	10/12/2020 11:21	09/12/2020 16:34	10/12/2020 11:21	18,77	1	18,77	CHI
20201250527	HIDROLANDIA	10017544082	PONTALINA	09/12/2020 16:35	10/12/2020 05:59	09/12/2020 16:35	10/12/2020 05:59	13,40	1	13,40	CHI
20201250529	SILVANIA	660028270	VIANOPOLIS	09/12/2020 16:35	10/12/2020 02:58	09/12/2020 16:35	10/12/2020 02:58	10,37	1	10,37	CHI
20201250711	INHUMAS	IN32066319	INHUMAS S2	09/12/2020 16:35	09/12/2020 20:51	09/12/2020 16:35	09/12/2020 20:51	4,25	15	63,76	CHI
20201250538	FORMOSA	610216223	ITUIQUIRA	09/12/2020 16:36	09/12/2020 17:40	09/12/2020 16:36	09/12/2020 17:40	1,06	1	1,06	CHI
20201250540	SAO SIMAO	PC12000071LD	CACHOEIRA ALTA	09/12/2020 16:36	10/12/2020 17:18	09/12/2020 16:36	10/12/2020 17:18	24,69	1	24,69	CHI
20201250555	JUSSARA	JR12341214	BRITANIA	09/12/2020 16:36	10/12/2020 10:15	09/12/2020 16:36	10/12/2020 10:15	17,65	3	52,94	CHI
20201250749	FAZENDA NOVA	FN18073972TS	JUSSARA	09/12/2020 16:36	10/12/2020 16:39	09/12/2020 16:36	10/12/2020 16:39	24,05	10	240,46	CHI
20201250749	FAZENDA NOVA	FN18073972TS	JUSSARA	09/12/2020 16:36	10/12/2020 16:39	10/12/2020 12:54	10/12/2020 16:39	3,76	20	75,12	CHI
20201250550	PIRACANJUBA	PJ21142494	PIRACANJUBA	09/12/2020 16:37	10/12/2020 10:47	09/12/2020 16:37	10/12/2020 10:47	18,15	1	18,15	CHI
20201250559	FORMOSA	FA21255316	ITUIQUIRA	09/12/2020 16:39	09/12/2020 19:37	09/12/2020 16:39	09/12/2020 19:37	2,96	1	2,96	CHI
20201250568	ITUMBIARA	IT12264052	ITUMBIARA NOVA	09/12/2020 16:41	10/12/2020 11:00	09/12/2020 16:41	10/12/2020 11:00	18,32	2	36,63	CHI
20201250573	PROFESSOR JAMIL SAFADY	MI10408274	PONTALINA	09/12/2020 16:42	10/12/2020 13:47	09/12/2020 16:42	09/12/2020 19:29	2,79	8	22,32	CHI
20201250573	MAIRIPOTABA	MI10408274	PONTALINA	09/12/2020 16:42	10/12/2020 13:47	09/12/2020 16:42	09/12/2020 19:29	2,79	4	11,16	CHI
20201250573	PIRACANJUBA	MI10408274	PONTALINA	09/12/2020 16:42	10/12/2020 13:47	09/12/2020 16:42	09/12/2020 19:29	2,79	1	2,79	CHI
20201250573	PROFESSOR JAMIL SAFADY	MI10408274	PONTALINA	09/12/2020 16:42	10/12/2020 13:47	09/12/2020 16:42	09/12/2020 20:50	4,15	37	153,47	CHI
20201250573	PONTALINA	MI10408274	PONTALINA	09/12/2020 16:42	10/12/2020 13:47	09/12/2020 16:42	10/12/2020 13:47	21,09	3	63,27	CHI
20201250573	MAIRIPOTABA	MI10408274	PONTALINA	09/12/2020 16:42	10/12/2020 13:47	09/12/2020 16:42	10/12/2020 13:47	21,09	2	42,18	CHI
20201250573	CEZARINA	MI10408274	PONTALINA	09/12/2020 16:42	10/12/2020 13:47	09/12/2020 16:42	10/12/2020 13:47	21,09	39	822,49	CHI
20201250573	VARJAO	MI10408274	PONTALINA	09/12/2020 16:42	10/12/2020 13:47	09/12/2020 16:42	10/12/2020 13:47	21,09	1	21,09	CHI
20201250573	PROFESSOR JAMIL SAFADY	MI10408274	PONTALINA	09/12/2020 16:42	10/12/2020 13:47	09/12/2020 16:42	10/12/2020 13:47	21,09	14	295,25	CHI
20201250573	CROMINIA	MI10408274	PONTALINA	09/12/2020 16:42	10/12/2020 13:47	09/12/2020 16:42	10/12/2020 13:47	21,09	10	210,89	CHI
20201250573	MAIRIPOTABA	JS13249822	PONTALINA	09/12/2020 16:42	10/12/2020 13:47	09/12/2020 16:42	10/12/2020 13:47	21,09	8	168,72	CHI

20201250573	PONTALINA	MI10408274	PONTALINA	09/12/2020 16:42	10/12/2020 13:47	09/12/2020 16:42	10/12/2020 13:47	21,09	61	1286,46	CHI
20201250573	MAIRIPOTABA	MI10408274	PONTALINA	09/12/2020 16:42	10/12/2020 13:47	09/12/2020 16:42	10/12/2020 13:47	21,09	67	1412,99	CHI
20201250573	HIDROLANDIA	MI10408274	PONTALINA	09/12/2020 16:42	10/12/2020 13:47	09/12/2020 16:42	10/12/2020 13:47	21,09	190	4006,99	CHI
20201250573	HIDROLANDIA	MI10408274	PONTALINA	09/12/2020 16:42	10/12/2020 13:47	09/12/2020 16:42	10/12/2020 13:47	21,09	4	84,36	CHI
20201250573	MAIRIPOTABA	MI10408274	PONTALINA	09/12/2020 16:42	10/12/2020 13:47	09/12/2020 16:42	10/12/2020 13:47	21,09	3	63,27	CHI
20201250573	CROMINIA	MI10408274	PONTALINA	09/12/2020 16:42	10/12/2020 13:47	09/12/2020 16:42	10/12/2020 13:47	21,09	1798	37918,82	CHI
20201250573	MAIRIPOTABA	MI10408274	PONTALINA	09/12/2020 16:42	10/12/2020 13:47	09/12/2020 16:42	10/12/2020 13:47	21,09	786	16576,30	CHI
20201250573	CROMINIA	MI10408274	PONTALINA	09/12/2020 16:42	10/12/2020 13:47	09/12/2020 16:42	10/12/2020 13:47	21,09	11	231,98	CHI
20201250573	MAIRIPOTABA	MI10408274	PONTALINA	09/12/2020 16:42	10/12/2020 13:47	09/12/2020 16:42	10/12/2020 13:47	21,09	10	210,89	CHI
20201250573	CROMINIA	MI10408274	PONTALINA	09/12/2020 16:42	10/12/2020 13:47	09/12/2020 16:42	10/12/2020 13:47	21,09	2	42,18	CHI
20201250573	CROMINIA	MI10408274	PONTALINA	09/12/2020 16:42	10/12/2020 13:47	09/12/2020 16:42	10/12/2020 13:47	21,09	18	379,61	CHI
20201250573	CROMINIA	JS13249822	PONTALINA	09/12/2020 16:42	10/12/2020 13:47	09/12/2020 16:42	10/12/2020 13:47	21,09	46	970,11	CHI
20201250573	MAIRIPOTABA	MI10408274	PONTALINA	09/12/2020 16:42	10/12/2020 13:47	09/12/2020 16:42	10/12/2020 13:47	21,09	359	7571,11	CHI
20201250573	PROFESSOR JAMIL SAFADY	JS13249822	PONTALINA	09/12/2020 16:42	10/12/2020 13:47	09/12/2020 16:42	10/12/2020 13:47	21,09	6	126,54	CHI
20201250573	PONTALINA	MI10408274	PONTALINA	09/12/2020 16:42	10/12/2020 13:47	09/12/2020 16:42	10/12/2020 13:47	21,09	34	717,04	CHI
20201250573	HIDROLANDIA	MI10408274	PONTALINA	09/12/2020 16:42	10/12/2020 13:47	09/12/2020 16:42	10/12/2020 13:47	21,09	75	1581,71	CHI
20201251067	NAZARIO	NZ12003900	ANICUNS	09/12/2020 16:42	10/12/2020 20:57	09/12/2020 16:42	09/12/2020 20:57	4,25	12	50,99	CHI
20201250593	FORMOSA	FA11269916	ITUIQUIRA	09/12/2020 16:43	09/12/2020 20:11	09/12/2020 16:43	09/12/2020 20:11	3,45	1	3,45	CHI
20201252166	MONTES CLAROS DE GOIAS	ME12380868	IPORA	09/12/2020 16:43	10/12/2020 09:01	09/12/2020 16:43	10/12/2020 00:25	7,70	2	15,40	CHI
20201252166	MONTES CLAROS DE GOIAS	ME12380868	IPORA	09/12/2020 16:43	10/12/2020 09:01	09/12/2020 16:43	10/12/2020 05:00	12,28	1	12,28	CHI
20201252166	MONTES CLAROS DE GOIAS	ME12380868	IPORA	09/12/2020 16:43	10/12/2020 09:01	09/12/2020 16:43	10/12/2020 08:23	15,66	1	15,66	CHI
20201252166	MONTES CLAROS DE GOIAS	ME12380868	IPORA	09/12/2020 16:43	10/12/2020 09:01	09/12/2020 16:43	10/12/2020 09:01	16,29	1	16,29	CHI
20201250602	FAINA	MP12355886	MATRINCHA	09/12/2020 16:45	10/12/2020 16:45	09/12/2020 16:45	10/12/2020 16:00	23,25	1	23,25	CHI
20201250602	ARAGUAPAZ	MP13355887	MATRINCHA	09/12/2020 16:45	10/12/2020 16:45	09/12/2020 16:45	10/12/2020 16:45	24,00	1	24,00	CHI
20201250602	FAINA	MP13355887	MATRINCHA	09/12/2020 16:45	10/12/2020 16:45	09/12/2020 16:45	10/12/2020 16:45	24,00	1	24,00	CHI
20201250604	APARECIDA DE GOIANIA	10005289007	ANHANGUERA	09/12/2020 16:45	09/12/2020 18:37	09/12/2020 16:45	09/12/2020 18:37	1,86	1	1,86	CHI
20201250607	ARAGARCAS	AG11207761	ARAGARCAS	09/12/2020 16:45	09/12/2020 18:04	09/12/2020 16:45	09/12/2020 18:04	1,31	109	142,28	CHI
20201250608	ARAGOIANIA	AO11117267	GUAPO S2	09/12/2020 16:45	09/12/2020 21:02	09/12/2020 16:45	09/12/2020 21:02	4,27	51	217,80	CHI
20201250612	GAMELEIRA DE GOIAS	LB12000008	DAIA S2	09/12/2020 16:45	09/12/2020 17:10	09/12/2020 16:45	09/12/2020 17:10	0,41	16	6,57	CHI
20201250612	SILVANIA	LB12000008	DAIA S2	09/12/2020 16:45	09/12/2020 17:10	09/12/2020 16:45	09/12/2020 17:10	0,41	98	40,23	CHI
20201250612	LEOPOLDO DE BULHOES	LB12000008	DAIA S2	09/12/2020 16:45	09/12/2020 17:10	09/12/2020 16:45	09/12/2020 17:10	0,41	159	65,28	CHI
20201250615	IVOLANDIA	IV21193252	IPORA	09/12/2020 16:45	10/12/2020 16:14	09/12/2020 16:45	10/12/2020 16:14	23,47	1	23,47	CHI
20201252753	AGUA FRIA DE GOIAS	PI12325588	SAO JOAO D ALIANCA	09/12/2020 16:45	10/12/2020 08:37	09/12/2020 16:45	10/12/2020 08:37	15,85	1	15,85	CHI
20201252753	PLANALTINA	PI12325588	SAO JOAO D ALIANCA	09/12/2020 16:45	10/12/2020 08:37	09/12/2020 16:45	10/12/2020 08:37	15,85	102	1616,93	CHI
20201250617	GOIANIA	17233938	CAMPINAS S1	09/12/2020 16:46	09/12/2020 18:01	09/12/2020 16:46	09/12/2020 18:01	1,25	1	1,25	CHI
20201250620	FLORES DE GOIAS	FB11286800	FLORES DE GOIAS	09/12/2020 16:46	11/12/2020 10:38	09/12/2020 16:46	11/12/2020 10:38	41,86	1	41,86	CHI
20201251003	CABECEIRAS	CW12398925	ITUIQUIRA	09/12/2020 16:46	09/12/2020 20:44	09/12/2020 16:46	09/12/2020 20:44	3,96	28	110,76	CHI
20201250629	ARAGOIANIA	AO21062639	GUAPO S2	09/12/2020 16:47	09/12/2020 22:30	09/12/2020 16:47	09/12/2020 22:30	5,71	2	11,42	CHI
20201250633	PORANGATU	PO12315466	PORANGATU	09/12/2020 16:47	09/12/2020 18:51	09/12/2020 16:47	09/12/2020 18:51	2,05	2	4,11	CHI
20201251166	RIO VERDE	RV12371494	SANTA HELENA S1	09/12/2020 16:47	10/12/2020 09:10	09/12/2020 16:47	10/12/2020 09:10	16,37	5	81,86	CHI
20201251166	QUIRINOPOLIS	RV12371494	SANTA HELENA S1	09/12/2020 16:47	10/12/2020 09:10	09/12/2020 16:47	10/12/2020 09:10	16,37	39	638,53	CHI
20201250636	LEOPOLDO DE BULHOES	LB21000002	DAIA S2	09/12/2020 16:48	10/12/2020 01:21	09/12/2020 16:48	10/12/2020 01:21	8,55	1	8,55	CHI
20201250637	RIO VERDE	630022045	RIO VERDE S2	09/12/2020 16:48	09/12/2020 22:48	09/12/2020 16:48	09/12/2020 22:48	6,01	1	6,01	CHI
20201250643	RIO QUENTE	2530029125	RIO QUENTE	09/12/2020 16:48	10/12/2020 10:05	09/12/2020 16:48	10/12/2020 10:05	17,28	1	17,28	CHI
20201250645	MINEIROS	MY21248433	PARQUE DAS EMAS	09/12/2020 16:48	10/12/2020 08:42	09/12/2020 16:48	10/12/2020 08:42	15,89	1	15,89	CHI
20201250646	GOIANIA	13959700	MEIA PONTE	09/12/2020 16:48	09/12/2020 23:53	09/12/2020 16:48	09/12/2020 23:53	7,07	1	7,07	CHI
20201251009	GOIANIA	GN11012784	FERROVIARIO S1	09/12/2020 16:48	09/12/2020 19:48	09/12/2020 16:48	09/12/2020 19:48	3,00	79	236,76	CHI
20201250652	RIO VERDE	10018840505	RIO VERDE S2	09/12/2020 16:50	10/12/2020 04:47	09/12/2020 16:50	10/12/2020 04:47	11,95	1	11,95	CHI
20201250653	CORUMBAIBA	IP12107653	IPAMERI	09/12/2020 16:50	10/12/2020 00:40	09/12/2020 16:50	10/12/2020 00:40	7,83	3	23,49	CHI
20201250653	CALDAS NOVAS	IP12107653	IPAMERI	09/12/2020 16:50	10/12/2020 00:40	09/12/2020 16:50	10/12/2020 00:40	7,83	11	86,15	CHI
20201250653	IPAMERI	IP12107653	IPAMERI	09/12/2020 16:50	10/12/2020 00:40	09/12/2020 16:50	10/12/2020 00:40	7,83	91	712,68	CHI

20201250657	GOIANIA	11253228	GOIANIA LESTE S1	09/12/2020 16:50	09/12/2020 18:57	09/12/2020 16:50	09/12/2020 18:57	2,11	1	2,11	CHI
20201251333	RIO VERDE	MV12214147	MONTIVIDIU T	09/12/2020 16:51	10/12/2020 04:17	09/12/2020 16:51	10/12/2020 04:17	11,43	2	22,86	CHI
20201251333	MONTIVIDIU	MV12214147	MONTIVIDIU T	09/12/2020 16:51	10/12/2020 04:17	09/12/2020 16:51	10/12/2020 04:17	11,43	3	34,29	CHI
20201250669	JATAI	10010786595	JATAI S2	09/12/2020 16:52	10/12/2020 10:00	09/12/2020 16:52	10/12/2020 10:00	17,13	1	17,13	CHI
20201250679	LEOPOLDO DE BULHOES	SV21011178	DAIA S2	09/12/2020 16:53	09/12/2020 22:21	09/12/2020 16:53	09/12/2020 22:21	5,45	1	5,45	CHI
20201250682	CAMPOS BELOS	CH12218811	SAO DOMINGOS	09/12/2020 16:54	09/12/2020 20:47	09/12/2020 16:54	09/12/2020 20:47	3,88	12	46,60	CHI
20201250686	PIRENOPOLIS	220035970	CORUMBA	09/12/2020 16:54	10/12/2020 12:10	09/12/2020 16:54	10/12/2020 12:10	19,27	1	19,27	CHI
20201250699	ITAPACI	100005391	ITAPACI	09/12/2020 16:55	09/12/2020 19:28	09/12/2020 16:55	09/12/2020 19:28	2,53	1	2,53	CHI
20201251153	PALMEIRAS DE GOIAS	PL12016686	PALMEIRAS	09/12/2020 16:56	09/12/2020 21:01	09/12/2020 16:56	09/12/2020 21:01	4,08	11	44,91	CHI
20201251933	CRISTALINA	KR12160112	CRISTALINA S2	09/12/2020 16:57	10/12/2020 10:02	09/12/2020 16:57	10/12/2020 10:02	17,07	18	307,34	CHI
20201250712	GOIANIA	10016335978	GOYA S2	09/12/2020 16:58	09/12/2020 19:53	09/12/2020 16:58	09/12/2020 19:53	2,91	1	2,91	CHI
20201250718	AGUA FRIA DE GOIAS	TL21152800	SAO JOAO D ALIANCA	09/12/2020 16:58	10/12/2020 07:26	09/12/2020 16:58	10/12/2020 07:26	14,45	1	14,45	CHI
20201250726	ITUMBUIARA	CD21122327	CACHOEIRA DOURADA	09/12/2020 17:00	09/12/2020 19:48	09/12/2020 17:00	09/12/2020 19:48	2,79	1	2,79	CHI
20201251574	CRIXAS	CX12145539	RUBIATABA	09/12/2020 17:01	09/12/2020 23:51	09/12/2020 17:01	09/12/2020 23:51	6,82	19	129,64	CHI
20201250875	BOM JESUS DE GOIAS	BJ12000347	BOM JESUS DE GOIAS	09/12/2020 17:02	10/12/2020 21:04	09/12/2020 17:02	10/12/2020 21:04	28,02	2	56,05	CHI
20201250781	GOIANIA	GN16421043	AEROPORTO S1	09/12/2020 17:04	09/12/2020 21:09	09/12/2020 17:04	09/12/2020 21:09	4,09	205	837,88	CHI
20201250781	GOIANIA	GN16421043	AEROPORTO S1	09/12/2020 17:04	09/12/2020 21:09	09/12/2020 20:59	09/12/2020 21:09	0,17	353	58,34	CHI
20201251429	SANTA RITA DO ARAGUAIA	SU12306464	SANTA RITA DO ARAGUAIA	09/12/2020 17:06	10/12/2020 07:05	09/12/2020 17:06	10/12/2020 07:05	13,98	79	1104,05	CHI
20201252474	PIRACANJUBA	PJ11182918	ROCHEDO	09/12/2020 17:06	10/12/2020 13:05	09/12/2020 17:06	10/12/2020 13:05	19,97	64	1278,04	CHI
20201250764	ANAPOLIS	20646227	ANAPOLIS UNIVERSITARIO S1	09/12/2020 17:07	10/12/2020 16:44	09/12/2020 17:07	10/12/2020 16:44	23,63	1	23,63	CHI
20201250778	GOIANIA	11806667	CAMPINAS S2	09/12/2020 17:09	09/12/2020 19:57	09/12/2020 17:09	09/12/2020 19:57	2,80	1	2,80	CHI
20201250783	GOIANIA	16585227	XAVANTES	09/12/2020 17:09	09/12/2020 21:34	09/12/2020 17:09	09/12/2020 21:34	4,40	1	4,40	CHI
20201250794	JUSSARA	JR12160186	BRITANIA	09/12/2020 17:09	10/12/2020 11:47	09/12/2020 17:09	10/12/2020 11:47	18,63	3	55,90	CHI
20201250788	SANTA TEREZA DE GOIAS	TB12170075	PORANGATU	09/12/2020 17:10	09/12/2020 20:20	09/12/2020 17:10	09/12/2020 20:20	3,16	3	9,47	CHI
20201250803	VALPARAISO DE GOIAS	3350102114	PACAEMBU S2	09/12/2020 17:13	10/12/2020 00:24	09/12/2020 17:13	10/12/2020 00:24	7,17	1	7,17	CHI
20201250810	APARECIDA DE GOIANIA	13575053	INDEPENDENCIA S2	09/12/2020 17:15	09/12/2020 20:32	09/12/2020 17:15	09/12/2020 20:32	3,28	1	3,28	CHI
20201250811	SITIO D ABADIA	SI12281611	IACIARA S2	09/12/2020 17:15	09/12/2020 22:11	09/12/2020 17:15	09/12/2020 22:11	4,93	1	4,93	CHI
20201250812	ALEXANIA	AX31185010	ALEXANIA	09/12/2020 17:15	09/12/2020 23:01	09/12/2020 17:15	09/12/2020 23:01	5,76	1	5,76	CHI
20201250858	SANTA HELENA DE GOIAS	SH11106517	IPEGUARI	09/12/2020 17:16	10/12/2020 01:33	09/12/2020 17:16	10/12/2020 01:33	8,27	48	397,13	CHI
20201250861	TEREZOPOLIS DE GOIAS	TJ12389754	DAIA S2	09/12/2020 17:16	09/12/2020 19:59	09/12/2020 17:16	09/12/2020 19:59	2,70	20	54,03	CHI
20201250861	GOIANAPOLIS	TJ12389754	DAIA S2	09/12/2020 17:16	09/12/2020 19:59	09/12/2020 17:16	09/12/2020 19:59	2,70	2	5,40	CHI
20201251069	JARAGUA	TQ12120364	INHUMAS S1	09/12/2020 17:16	09/12/2020 21:33	09/12/2020 17:16	09/12/2020 21:33	4,28	2	8,56	CHI
20201251069	TAQUARAL DE GOIAS	TQ12120364	INHUMAS S1	09/12/2020 17:16	09/12/2020 21:33	09/12/2020 17:16	09/12/2020 21:33	4,28	19	81,30	CHI
20201251069	SANTA ROSA DE GOIAS	TQ12120364	INHUMAS S1	09/12/2020 17:16	09/12/2020 21:33	09/12/2020 17:16	09/12/2020 21:33	4,28	19	81,30	CHI
20201250827	GOIANIA	10006572411	CARAJAS S1	09/12/2020 17:17	09/12/2020 19:55	09/12/2020 17:17	09/12/2020 19:55	2,63	1	2,63	CHI
20201250835	SANTO ANTONIO DO DESCOBERTO	SN12393600	MARAJOARA	09/12/2020 17:18	09/12/2020 19:10	09/12/2020 17:18	09/12/2020 19:10	1,86	4	7,45	CHI
20201250839	GOIANIA	17032544	XAVANTES	09/12/2020 17:19	09/12/2020 21:04	09/12/2020 17:19	09/12/2020 21:04	3,75	1	3,75	CHI
20201250844	GOIANIA	12109459	GOYA S1	09/12/2020 17:19	09/12/2020 20:41	09/12/2020 17:19	09/12/2020 20:41	3,36	1	3,36	CHI
20201250962	BELA VISTA DE GOIAS	BV12000046	CEPAIGO S2	09/12/2020 17:19	09/12/2020 23:38	09/12/2020 17:19	09/12/2020 23:38	6,31	31	195,53	CHI
20201251850	JANDAIA	JD12008610	PALMEIRAS	09/12/2020 17:19	10/12/2020 00:36	09/12/2020 17:19	10/12/2020 00:36	7,28	8	58,25	CHI
20201250853	GOIANIA	15392351	CARAJAS S1	09/12/2020 17:20	09/12/2020 20:13	09/12/2020 17:20	09/12/2020 20:13	2,87	1	2,87	CHI
20201251405	ORIZONA	OZ12084921RE	PIRES DO RIO S2	09/12/2020 17:21	09/12/2020 23:34	09/12/2020 17:21	09/12/2020 23:34	6,21	110	682,73	CHI
20201251405	VIANOPOLIS	OZ12084921RE	PIRES DO RIO S2	09/12/2020 17:21	09/12/2020 23:34	09/12/2020 17:21	09/12/2020 23:34	6,21	17	105,51	CHI
20201250865	PILAR DE GOIAS	HL21238590	SANTA TEREZINHA	09/12/2020 17:22	09/12/2020 20:10	09/12/2020 17:22	09/12/2020 20:10	2,80	2	5,60	CHI
20201250866	URUACU	UR21390909	CAMPINORTE	09/12/2020 17:22	10/12/2020 12:35	09/12/2020 17:22	10/12/2020 12:35	19,22	1	19,22	CHI
20201250870	AMARALINA	LC1208583	MARA ROSA	09/12/2020 17:22	10/12/2020 10:12	09/12/2020 17:22	10/12/2020 10:12	16,82	1	16,82	CHI
20201250874	APARECIDA DE GOIANIA	13772430	INDEPENDENCIA S2	09/12/2020 17:23	10/12/2020 03:49	09/12/2020 17:23	10/12/2020 03:49	10,43	1	10,43	CHI
20201250880	FORMOSA	FA32051122	ITUIQUIRA	09/12/2020 17:24	10/12/2020 11:40	09/12/2020 17:24	10/12/2020 11:40	18,28	8	146,21	CHI
20201250881	PLANALTINA	PI21365334	SAO JOAO D ALIANCA	09/12/2020 17:24	09/12/2020 22:19	09/12/2020 17:24	09/12/2020 22:19	4,92	1	4,92	CHI
20201250883	TROMBAS	TB12202556	PORANGATU	09/12/2020 17:24	09/12/2020 23:22	09/12/2020 17:24	09/12/2020 23:22	5,96	2	11,91	CHI
20201250885	JATAI	290241250	JATAI S2	09/12/2020 17:24	10/12/2020 11:04	09/12/2020 17:24	10/12/2020 11:04	17,65	1	17,65	CHI

20201251676	MINEIROS	PW12374393	PARQUE DAS EMAS	09/12/2020 17:24	09/12/2020 21:15	09/12/2020 17:24	09/12/2020 21:15	3,84	5	19,18	CHI
20201250890	IVOLANDIA	IV21316416	IPORA	09/12/2020 17:25	09/12/2020 21:10	09/12/2020 17:25	09/12/2020 21:10	3,74	1	3,74	CHI
20201250894	GOIANIA	14345997	CARAJAS S1	09/12/2020 17:26	09/12/2020 21:44	09/12/2020 17:26	09/12/2020 21:44	4,29	1	4,29	CHI
20201250899	CRISTALINA	KR21341542	CRISTALINA S1	09/12/2020 17:26	10/12/2020 09:29	09/12/2020 17:26	10/12/2020 09:29	16,04	1	16,04	CHI
20201250900	FAZENDA NOVA	FN21141469	JUSSARA	09/12/2020 17:26	10/12/2020 12:45	09/12/2020 17:26	10/12/2020 12:45	19,30	1	19,30	CHI
20201250901	CALDAS NOVAS	760054952	SERRA DE CALDAS	09/12/2020 17:27	09/12/2020 20:10	09/12/2020 17:27	09/12/2020 20:10	2,72	1	2,72	CHI
20201250907	GOIANIA	10178831	FERROVIARIO S3	09/12/2020 17:28	09/12/2020 20:43	09/12/2020 17:28	09/12/2020 20:43	3,25	1	3,25	CHI
20201251117	MONTE ALEGRE DE GOIAS	MA12212699	SAO DOMINGOS	09/12/2020 17:28	09/12/2020 20:41	09/12/2020 17:28	09/12/2020 20:41	3,21	66	211,88	CHI
20201252559	SANTA RITA DO ARAGUAIA	SU11000004	SANTA RITA DO ARAGUAIA	09/12/2020 17:28	10/12/2020 00:06	09/12/2020 17:28	10/12/2020 00:06	6,63	59	391,12	CHI
20201250921	MINACU	IH10400757	MINACU	09/12/2020 17:29	09/12/2020 21:46	09/12/2020 17:29	09/12/2020 21:46	4,29	347	1487,18	CHI
20201250924	NAZARIO	NZ21285452	ANICUNS	09/12/2020 17:30	09/12/2020 18:55	09/12/2020 17:30	09/12/2020 18:55	1,41	1	1,41	CHI
20201250933	QUIRINOPOLIS	QI12384049	BOM JESUS DE GOIAS	09/12/2020 17:31	10/12/2020 21:25	09/12/2020 17:31	10/12/2020 21:25	27,89	3	83,67	CHI
20201250938	ALEXANIA	AX21374688	ALEXANIA	09/12/2020 17:32	09/12/2020 21:32	09/12/2020 17:32	09/12/2020 21:32	3,99	1	3,99	CHI
20201250942	CRISTALINA	KR12287383	CRISTALINA S1	09/12/2020 17:32	10/12/2020 12:25	09/12/2020 17:32	10/12/2020 12:25	18,87	86	1622,96	CHI
20201250949	MUNDO NOVO DE GOIAS	MH21035214	NOVA CRIXAS	09/12/2020 17:33	09/12/2020 19:06	09/12/2020 17:33	09/12/2020 19:06	1,54	1	1,54	CHI
20201250954	CALDAS NOVAS	10017648031	SERRA DE CALDAS	09/12/2020 17:34	10/12/2020 10:48	09/12/2020 17:34	10/12/2020 10:48	17,23	1	17,23	CHI
20201250961	PORANGATU	PO12252098	PORANGATU	09/12/2020 17:35	09/12/2020 21:39	09/12/2020 17:35	09/12/2020 21:39	4,06	5	20,29	CHI
20201250963	CACHOEIRA ALTA	CA21075136	CACHOEIRA ALTA	09/12/2020 17:35	10/12/2020 09:48	09/12/2020 17:35	10/12/2020 09:48	16,21	1	16,21	CHI
20201250966	FLORES DE GOIAS	FB11255014	FLORES DE GOIAS	09/12/2020 17:35	10/12/2020 12:11	09/12/2020 17:35	10/12/2020 12:11	18,59	13	241,62	CHI
20201250967	ITABERAI	IB11336375	ITABERAI S2	09/12/2020 17:35	10/12/2020 08:10	09/12/2020 17:35	10/12/2020 08:10	14,57	63	917,86	CHI
20201251287	CRISTALINA	KR12118416	PAMPLONA	09/12/2020 17:35	10/12/2020 09:07	09/12/2020 17:35	10/12/2020 09:07	15,53	2	31,06	CHI
20201250968	ANAPOLIS	20835395	JUNDIAI S2	09/12/2020 17:36	09/12/2020 21:43	09/12/2020 17:36	09/12/2020 21:43	4,12	1	4,12	CHI
20201250969	ITAUUCU	IX21114682	INHUMAS S1	09/12/2020 17:36	09/12/2020 22:34	09/12/2020 17:36	09/12/2020 22:34	4,96	1	4,96	CHI
20201250977	LUZIANIA	LZ1245522	PIRES DO RIO S2	09/12/2020 17:39	10/12/2020 21:59	09/12/2020 17:39	10/12/2020 21:59	28,32	1	28,32	CHI
20201251632	LUZIANIA	LZ12261764	MARAJOARA	09/12/2020 17:39	10/12/2020 09:46	09/12/2020 17:39	10/12/2020 09:46	16,10	2	32,20	CHI
20201250982	UIRAPURU	UP11055328	SANTA TEREZINHA	09/12/2020 17:40	10/12/2020 17:05	10/12/2020 08:03	10/12/2020 17:05	9,02	134	1208,83	CHI
20201251014	CRIXAS	CX12318761	RUBIATABA	09/12/2020 17:40	10/12/2020 13:22	09/12/2020 17:40	10/12/2020 13:22	19,68	10	196,84	CHI
202012179359	UIRAPURU	4200006407	SANTA TEREZINHA	09/12/2020 17:40	10/12/2020 08:03	09/12/2020 17:40	10/12/2020 08:03	14,39	1	14,39	CHI
20201250988	GOIANIA	10010319075	GOYA S1	09/12/2020 17:41	09/12/2020 18:43	09/12/2020 17:41	09/12/2020 18:43	1,03	1	1,03	CHI
20201251652	SAO DOMINGOS	SD11046233	SAO DOMINGOS	09/12/2020 17:41	09/12/2020 21:47	09/12/2020 17:41	09/12/2020 21:47	4,10	143	585,62	CHI
20201250995	APARECIDA DE GOIANIA	10005389249	ATLANTICO S1	09/12/2020 17:43	09/12/2020 19:15	09/12/2020 17:43	09/12/2020 19:15	1,52	1	1,52	CHI
20201251256	CIDADE OCIDENTAL	LZ12255588	RIO VERMELHO	09/12/2020 17:43	10/12/2020 10:46	09/12/2020 17:43	10/12/2020 10:46	17,04	9	153,40	CHI
20201251256	LUZIANIA	LZ12255588	RIO VERMELHO	09/12/2020 17:43	10/12/2020 10:46	09/12/2020 17:43	10/12/2020 10:46	17,04	1	17,04	CHI
20201251809	MUNDO NOVO DE GOIAS	MH12357676	NOVA CRIXAS	09/12/2020 17:43	10/12/2020 01:11	09/12/2020 17:43	10/12/2020 01:11	7,46	24	179,13	CHI
20201250997	MINEIROS	MY11348217	PARQUE DAS EMAS	09/12/2020 17:44	09/12/2020 22:26	09/12/2020 17:44	09/12/2020 22:26	4,69	1	4,69	CHI
20201250999	ORIZONA	2060017460	PIRES DO RIO S2	09/12/2020 17:44	10/12/2020 09:50	09/12/2020 17:44	10/12/2020 09:50	16,09	1	16,09	CHI
20201251004	PALMEIRAS DE GOIAS	PL21000060	PALMEIRAS	09/12/2020 17:45	09/12/2020 20:34	09/12/2020 17:45	09/12/2020 20:34	2,81	1	2,81	CHI
20201251012	ANAPOLIS	AN21017820	ANAPOLIS UNIVERSITARIO S2	09/12/2020 17:46	09/12/2020 22:22	09/12/2020 17:46	09/12/2020 22:22	4,59	1	4,59	CHI
20201251122	QUIRINOPOLIS	QI12303070	QUIRINOPOLIS	09/12/2020 17:46	10/12/2020 18:56	09/12/2020 17:46	10/12/2020 14:07	20,34	4	81,37	CHI
20201251122	QUIRINOPOLIS	QI12303070	QUIRINOPOLIS	09/12/2020 17:46	10/12/2020 18:56	09/12/2020 17:46	10/12/2020 18:39	24,89	11	273,74	CHI
20201251122	QUIRINOPOLIS	QI12303070	QUIRINOPOLIS	09/12/2020 17:46	10/12/2020 18:56	09/12/2020 17:46	10/12/2020 18:56	25,17	11	276,91	CHI
20201251177	LEOPOLDO DE BULHOES	LB11200587	DAIA S2	09/12/2020 17:48	09/12/2020 20:43	09/12/2020 17:48	09/12/2020 20:43	2,90	75	217,87	CHI
20201251021	SANTA RITA DO ARAGUAIA	2130004411	SANTA RITA DO ARAGUAIA	09/12/2020 17:49	10/12/2020 08:14	09/12/2020 17:49	10/12/2020 08:14	14,41	1	14,41	CHI
20201251029	PIRACANJUBA	PJ21182745	PIRACANJUBA	09/12/2020 17:49	10/12/2020 09:53	09/12/2020 17:49	10/12/2020 09:53	16,05	1	16,05	CHI
20201250338	NIQUELANDIA	TI12237626RE	MINACU	09/12/2020 17:50	10/12/2020 04:14	09/12/2020 17:50	10/12/2020 04:14	10,40	1	10,40	CHI
20201250338	COLINAS DO SUL	TI12237626RE	MINACU	09/12/2020 17:50	10/12/2020 04:14	09/12/2020 17:50	10/12/2020 04:14	10,40	54	561,56	CHI
20201250338	URUACU	TI12237626RE	MINACU	09/12/2020 17:50	10/12/2020 04:14	09/12/2020 17:50	10/12/2020 04:14	10,40	1	10,40	CHI
20201251032	RIO VERDE	MV21260811	MONTIVIDIU T	09/12/2020 17:50	09/12/2020 21:58	09/12/2020 17:50	09/12/2020 21:58	4,13	1	4,13	CHI
20201251033	PORANGATU	PO12064910	NOVO PLANALTO	09/12/2020 17:50	09/12/2020 21:49	09/12/2020 17:50	09/12/2020 21:49	3,98	3	11,93	CHI
2020120900045	CORUMBA DE GOIAS	02002	ANAPOLIS UNIVERSITARIO S1	09/12/2020 17:50	09/12/2020 17:53	09/12/2020 17:50	09/12/2020 17:53	0,05	4	0,20	CHI
2020120900045	ABADIA DE GOIAS	02002	ANAPOLIS UNIVERSITARIO S1	09/12/2020 17:50	09/12/2020 17:53	09/12/2020 17:50	09/12/2020 17:53	0,05	1	0,05	CHI

2020120900045	ABADIANIA	02001	ANAPOLIS UNIVERSITARIO S1	09/12/2020 17:50	09/12/2020 17:53	09/12/2020 17:50	09/12/2020 17:53	0,05	1489	74,45	CHI
2020120900045	GAMELEIRA DE GOIAS	02002	ANAPOLIS UNIVERSITARIO S1	09/12/2020 17:50	09/12/2020 17:53	09/12/2020 17:50	09/12/2020 17:53	0,05	11	0,55	CHI
2020120900045	ANAPOLIS	00050424	ANAPOLIS UNIVERSITARIO S1	09/12/2020 17:50	09/12/2020 17:53	09/12/2020 17:50	09/12/2020 17:53	0,05	111	5,55	CHI
2020120900045	CORUMBA DE GOIAS	02001	ANAPOLIS UNIVERSITARIO S1	09/12/2020 17:50	09/12/2020 17:53	09/12/2020 17:50	09/12/2020 17:53	0,05	64	3,20	CHI
2020120900045	ABADIANIA	00050424	ANAPOLIS UNIVERSITARIO S1	09/12/2020 17:50	09/12/2020 17:53	09/12/2020 17:50	09/12/2020 17:53	0,05	18	0,90	CHI
2020120900045	ABADIANIA	02002	ANAPOLIS UNIVERSITARIO S1	09/12/2020 17:50	09/12/2020 17:53	09/12/2020 17:50	09/12/2020 17:53	0,05	3619	180,95	CHI
20201251418	ITAPIRAPUA	IU12018852	MATRINCHA	09/12/2020 17:51	10/12/2020 22:02	09/12/2020 17:51	10/12/2020 22:02	28,17	36	1014,15	CHI
20201251042	MORRINHOS	MR21102222	MORRINHOS	09/12/2020 17:52	09/12/2020 23:28	09/12/2020 17:52	09/12/2020 23:28	5,59	1	5,59	CHI
20201251046	AGUA FRIA DE GOIAS	TL21151815	SAO JOAO D ALIANCA	09/12/2020 17:53	10/12/2020 02:19	09/12/2020 17:53	10/12/2020 02:19	8,43	1	8,43	CHI
20201251047	PIRANHAS	PH12207935	PIRANHAS	09/12/2020 17:53	09/12/2020 19:28	09/12/2020 17:53	09/12/2020 19:28	1,58	4	6,31	CHI
20201251052	ABADIANIA	AA21101468	ANAPOLIS UNIVERSITARIO S1	09/12/2020 17:54	09/12/2020 20:23	09/12/2020 17:54	09/12/2020 20:23	2,48	1	2,48	CHI
20201251053	GOIATUBA	JV21159152	GOIATUBA S1	09/12/2020 17:54	09/12/2020 20:49	09/12/2020 17:54	09/12/2020 20:49	2,90	1	2,90	CHI
20201251056	SANTA HELENA DE GOIAS	400040980	ACREUNA	09/12/2020 17:55	10/12/2020 04:50	09/12/2020 17:55	10/12/2020 04:50	10,92	1	10,92	CHI
20201251061	BOM JESUS DE GOIAS	BJ21205362	RIO DOS BOIS	09/12/2020 17:55	10/12/2020 14:09	09/12/2020 17:55	10/12/2020 14:09	20,24	2	40,47	CHI
20201251062	CORUMBAIBA	10009860329	VILA CORUMBA	09/12/2020 17:55	09/12/2020 22:09	09/12/2020 17:55	09/12/2020 22:09	4,22	1	4,22	CHI
20201251085	NEROPOLIS	NR12321531	NEROPOLIS S2	09/12/2020 17:55	09/12/2020 21:11	09/12/2020 17:55	09/12/2020 21:11	3,25	5	16,27	CHI
20201251085	SANTO ANTONIO DE GOIAS	NR12321531	NEROPOLIS S2	09/12/2020 17:55	09/12/2020 21:11	09/12/2020 17:55	09/12/2020 21:11	3,25	4	13,02	CHI
20201251349	CAMPO ALEGRE DE GOIAS	CM12156359	CAMPO ALEGRE DE GOIAS	09/12/2020 17:55	09/12/2020 21:43	09/12/2020 17:55	09/12/2020 21:43	3,78	31	117,29	CHI
20201251066	CALDAS NOVAS	CN12182800LD	SERRA DE CALDAS	09/12/2020 17:56	10/12/2020 13:18	09/12/2020 17:56	10/12/2020 11:27	17,53	9	157,77	CHI
20201251066	CALDAS NOVAS	CN12182800LD	SERRA DE CALDAS	09/12/2020 17:56	10/12/2020 13:18	09/12/2020 17:56	10/12/2020 13:18	19,38	1	19,38	CHI
20201251376	ANAPOLIS	AN11398566	ANAPOLIS UNIVERSITARIO S2	09/12/2020 17:56	09/12/2020 19:25	09/12/2020 17:56	09/12/2020 19:25	1,47	87	128,13	CHI
20201252495	JANDAIA	JD12008602	PALMEIRAS	09/12/2020 17:56	10/12/2020 09:42	09/12/2020 17:56	10/12/2020 09:42	15,75	9	141,76	CHI
20201251075	MORRINHOS	150126396	MORRINHOS	09/12/2020 17:57	09/12/2020 21:29	09/12/2020 17:57	09/12/2020 21:29	3,53	1	3,53	CHI
20201251084	LUZIANIA	LZ21335899	MARAJOARA	09/12/2020 17:58	10/12/2020 00:38	09/12/2020 17:58	10/12/2020 00:38	6,66	1	6,66	CHI
20201251086	GOUVELANDIA	GB21296586	QUIRINOPOLIS	09/12/2020 17:58	10/12/2020 15:11	09/12/2020 17:58	10/12/2020 15:11	21,20	1	21,20	CHI
20201251895	ANAPOLIS	AN12285251	ANAPOLIS UNIVERSITARIO S2	09/12/2020 17:58	10/12/2020 01:24	09/12/2020 17:58	10/12/2020 01:24	7,42	4	29,67	CHI
20201251895	PIRENOPOLIS	AN12285251	ANAPOLIS UNIVERSITARIO S2	09/12/2020 17:58	10/12/2020 01:24	09/12/2020 17:58	10/12/2020 01:24	7,42	5	37,09	CHI
20201251895	ABADIANIA	AN12285251	ANAPOLIS UNIVERSITARIO S2	09/12/2020 17:58	10/12/2020 01:24	09/12/2020 17:58	10/12/2020 01:24	7,42	4	29,67	CHI
20201252029	LUZIANIA	LZ12383059	CRISTALINA S2	09/12/2020 17:58	09/12/2020 23:33	09/12/2020 17:58	09/12/2020 23:33	5,58	143	797,38	CHI
20201251094	FORMOSA	610192723	ITUIQUIRA	09/12/2020 17:59	09/12/2020 20:11	09/12/2020 17:59	09/12/2020 20:11	2,21	1	2,21	CHI
20201251098	GOIANIA	15483204	GOYA S1	09/12/2020 17:59	09/12/2020 21:20	09/12/2020 17:59	09/12/2020 21:20	3,34	1	3,34	CHI
20201251100	ITABERAI	GS12206906	ITABERAI S1	09/12/2020 17:59	09/12/2020 23:13	09/12/2020 17:59	09/12/2020 23:13	5,22	9	47,00	CHI
20201251100	GOIAS	GS12206906	ITABERAI S1	09/12/2020 17:59	09/12/2020 23:13	09/12/2020 17:59	09/12/2020 23:13	5,22	2	10,44	CHI
20201251341	SIMOLANDIA	SA11262277	IACIARA S2	09/12/2020 17:59	10/12/2020 01:39	09/12/2020 17:59	10/12/2020 01:39	7,66	105	804,50	CHI
20201251571	COCALZINHO DE GOIAS	ZN21242377	COCALZINHO	09/12/2020 17:59	10/12/2020 18:57	09/12/2020 17:59	10/12/2020 18:57	24,96	1	24,96	CHI
20201251109	BONOPOLIS	BX21168224	SAO MIGUEL DO ARAGUAIA	09/12/2020 18:00	10/12/2020 01:44	09/12/2020 18:00	10/12/2020 01:44	7,72	1	7,72	CHI
20201251113	APARECIDA DE GOIANIA	14550532	INDEPENDENCIA S1	09/12/2020 18:00	09/12/2020 20:03	09/12/2020 18:00	09/12/2020 20:03	2,04	1	2,04	CHI
20201251114	MINEIROS	MY12296320RE	PARQUE DAS EMAS	09/12/2020 18:00	10/12/2020 00:20	09/12/2020 18:00	10/12/2020 00:20	6,34	11	69,79	CHI
20201251363	COCALZINHO DE GOIAS	ZN12084617	AGUAS LINDAS DE GOIAS S2	09/12/2020 18:00	09/12/2020 21:43	09/12/2020 18:00	09/12/2020 21:43	3,71	26	96,57	CHI
20201251116	ORIZONA	OZ12023017	PIRES DO RIO S2	09/12/2020 18:01	10/12/2020 11:16	09/12/2020 18:01	10/12/2020 11:16	17,25	7	120,74	CHI
20201251208	VILA PROPICIO	NP11327920	GOIANESIA S1	09/12/2020 18:02	10/12/2020 08:57	09/12/2020 18:02	10/12/2020 08:57	14,90	1	14,90	CHI
20201251301	ITUMBIARA	ID10404156	QUIRINOPOLIS	09/12/2020 18:03	09/12/2020 19:51	09/12/2020 18:03	09/12/2020 19:51	1,79	3	5,36	CHI
20201251301	INACIOLANDIA	ID10404156	QUIRINOPOLIS	09/12/2020 18:03	09/12/2020 19:51	09/12/2020 18:03	09/12/2020 19:51	1,79	897	1602,14	CHI
20201251541	APARECIDA DE GOIANIA	AP11063769	REAL S1	09/12/2020 18:03	09/12/2020 20:31	09/12/2020 18:03	09/12/2020 20:31	2,45	150	367,67	CHI
20201252049	URUACU	UR12082989	URUACU	09/12/2020 18:03	10/12/2020 02:35	09/12/2020 18:03	10/12/2020 02:35	8,52	6	51,14	CHI
20201251134	TURVANIA	FR12105326	FIRMINOPOLIS S1	09/12/2020 18:04	10/12/2020 10:17	09/12/2020 18:04	10/12/2020 10:17	16,22	3	48,65	CHI
20201251631	CACU	CC11242153	CACHOEIRA ALTA	09/12/2020 18:04	10/12/2020 01:18	09/12/2020 18:04	10/12/2020 01:18	7,23	132	954,62	CHI
20201250045	MINACU	IH11135600	MINACU	09/12/2020 18:05	10/12/2020 16:07	09/12/2020 18:05	10/12/2020 15:49	21,74	55	1195,58	CHI
20201250045	MINACU	IH11026974	MINACU	09/12/2020 18:05	10/12/2020 16:07	10/12/2020 11:25	10/12/2020 16:07	4,70	120	564,27	CHI
20201251142	MAMBAI	MB12170571	IACIARA S2	09/12/2020 18:05	09/12/2020 20:09	09/12/2020 18:05	09/12/2020 20:09	2,05	100	205,14	CHI
20201251147	CATURAI	CK21028658	ARACU	09/12/2020 18:06	10/12/2020 08:33	09/12/2020 18:06	10/12/2020 08:33	14,44	1	14,44	CHI

20201251149	INACIOLANDIA	CD21000095	CACHOEIRA DOURADA	09/12/2020 18:06	10/12/2020 08:31	09/12/2020 18:06	10/12/2020 08:31	14,41	1	14,41	CHI
20201251150	RIO VERDE	10002229879	RIO VERDE S1	09/12/2020 18:06	09/12/2020 21:16	09/12/2020 18:06	09/12/2020 21:16	3,15	1	3,15	CHI
20201251151	CATALAO	1990151192	CATALAO S2	09/12/2020 18:07	09/12/2020 21:55	09/12/2020 18:07	09/12/2020 21:55	3,80	1	3,80	CHI
20201251164	EDEALINA	ED31022485	PONTALINA	09/12/2020 18:09	09/12/2020 20:32	09/12/2020 18:09	09/12/2020 20:32	2,38	1	2,38	CHI
20201251167	MINEIROS	MY21336471	PARQUE DAS EMAS	09/12/2020 18:09	09/12/2020 22:51	09/12/2020 18:09	09/12/2020 22:51	4,69	1	4,69	CHI
20201251272	BOM JESUS DE GOIAS	BJ12000202	CACHOEIRA DOURADA	09/12/2020 18:09	09/12/2020 23:33	09/12/2020 18:09	09/12/2020 23:33	5,39	23	124,02	CHI
20201251272	GOIATUBA	BJ12000202	CACHOEIRA DOURADA	09/12/2020 18:09	09/12/2020 23:33	09/12/2020 18:09	09/12/2020 23:33	5,39	6	32,35	CHI
20201251272	PANAMA	BJ12000202	CACHOEIRA DOURADA	09/12/2020 18:09	09/12/2020 23:33	09/12/2020 18:09	09/12/2020 23:33	5,39	2	10,78	CHI
20201252496	JANDAIA	JD12377185	PALMEIRAS	09/12/2020 18:10	10/12/2020 12:34	09/12/2020 18:10	10/12/2020 12:34	18,40	28	515,15	CHI
20201251181	GOIANIA	10005111305	CARAJAS S1	09/12/2020 18:11	09/12/2020 20:49	09/12/2020 18:11	09/12/2020 20:49	2,63	1	2,63	CHI
20201251182	JATAI	10021085399	JATAI S2	09/12/2020 18:11	10/12/2020 09:41	09/12/2020 18:11	10/12/2020 09:41	15,50	1	15,50	CHI
20201251806	CORREGO DO OURO	CO12200893	SAO LUIZ DOS MONTES BELOS	09/12/2020 18:11	10/12/2020 10:01	09/12/2020 18:11	10/12/2020 10:01	15,83	4	63,30	CHI
20201251188	GOIANIA	11809528	REAL S1	09/12/2020 18:12	09/12/2020 23:52	09/12/2020 18:12	09/12/2020 23:52	5,67	1	5,67	CHI
20201251193	PILAR DE GOIAS	UR21339927	SANTA TEREZINHA	09/12/2020 18:12	11/12/2020 23:58	09/12/2020 18:12	11/12/2020 23:58	53,76	1	53,76	CHI
20201251200	GOIAS	GS21124354	ITABERAI S1	09/12/2020 18:14	10/12/2020 19:20	09/12/2020 18:14	10/12/2020 19:08	24,90	2	49,79	CHI
20201251200	GOIAS	GS12310470	ITABERAI S1	09/12/2020 18:14	10/12/2020 19:20	10/12/2020 16:10	10/12/2020 19:20	3,18	1	3,18	CHI
20201251209	SANTO ANTONIO DO DESCOBERTO	SN11164926	ALEXANIA	09/12/2020 18:15	09/12/2020 20:09	09/12/2020 18:15	09/12/2020 20:09	1,89	173	326,30	CHI
20201251218	CRISTALINA	KR21133601	CRISTALINA S1	09/12/2020 18:16	10/12/2020 11:41	09/12/2020 18:16	10/12/2020 11:41	17,40	1	17,40	CHI
20201251227	GOIANIA	GN21032237	GOYA S2	09/12/2020 18:18	09/12/2020 22:03	09/12/2020 18:18	09/12/2020 22:03	3,73	1	3,73	CHI
20201251228	CRISTALINA	KR21330679	CRISTALINA S1	09/12/2020 18:19	10/12/2020 11:01	09/12/2020 18:19	10/12/2020 11:01	16,70	1	16,70	CHI
20201251234	VILA PROPICIO	GE21216792	CORUMBA	09/12/2020 18:19	10/12/2020 13:22	09/12/2020 18:19	10/12/2020 13:22	19,04	1	19,04	CHI
20201251509	JARAGUA	JA12374473	JARAGUA	09/12/2020 18:19	09/12/2020 21:26	09/12/2020 18:19	09/12/2020 21:26	3,11	267	830,15	CHI
20201251238	COLINAS DO SUL	TI21236628	MINACU	09/12/2020 18:20	10/12/2020 05:19	09/12/2020 18:20	10/12/2020 05:19	10,98	2	21,95	CHI
20201251239	JATAI	JT11083443	JATAI S2	09/12/2020 18:20	10/12/2020 10:02	09/12/2020 18:20	10/12/2020 10:02	15,69	1	15,69	CHI
20201251240	ANAPOLIS	10015556210	ANAPOLIS UNIVERSITARIO S2	09/12/2020 18:20	10/12/2020 01:03	09/12/2020 18:20	10/12/2020 01:03	6,72	1	6,72	CHI
20201251241	CACHOEIRA DOURADA	CD21000132	CACHOEIRA DOURADA	09/12/2020 18:20	10/12/2020 18:18	09/12/2020 18:20	10/12/2020 18:18	23,95	1	23,95	CHI
20201251242	CABECEIRAS	CW21154476	ITUIQUIRA	09/12/2020 18:20	09/12/2020 21:24	09/12/2020 18:20	09/12/2020 21:24	3,05	1	3,05	CHI
20201251634	MOSSAMEDES	MD12299605	ITABERAI S2	09/12/2020 18:20	09/12/2020 21:44	09/12/2020 18:20	09/12/2020 21:44	3,39	5	16,97	CHI
20201251804	ITAPIRAPUA	IU12121382	MATRINCHA	09/12/2020 18:22	10/12/2020 14:53	09/12/2020 18:22	10/12/2020 14:53	20,51	14	287,20	CHI
20201251254	PIRES DO RIO	PR12404784	PIRES DO RIO S1	09/12/2020 18:23	09/12/2020 21:47	09/12/2020 18:23	09/12/2020 21:47	3,39	237	803,23	CHI
20201251259	CAIAPONIA	CP11292042	CAIAPONIA	09/12/2020 18:24	10/12/2020 09:45	09/12/2020 18:24	10/12/2020 09:45	15,34	1	15,34	CHI
20201251266	GOIANIA	16614938	FERROVIARIO S3	09/12/2020 18:25	09/12/2020 21:47	09/12/2020 18:25	09/12/2020 21:47	3,37	1	3,37	CHI
20201251288	PILAR DE GOIAS	1020004360	SANTA TEREZINHA	09/12/2020 18:27	09/12/2020 23:24	09/12/2020 18:27	09/12/2020 23:24	4,95	1	4,95	CHI
20201251289	LUZIANIA	LZ21120189	MARAJOARA	09/12/2020 18:27	10/12/2020 01:27	09/12/2020 18:27	10/12/2020 01:27	6,99	1	6,99	CHI
20201252170	GOIANIA	GN11001267	CARAJAS S2	09/12/2020 18:27	09/12/2020 21:29	09/12/2020 18:27	09/12/2020 21:29	3,03	169	512,54	CHI
20201248614	FAINA	FC12274421	GOIAS	09/12/2020 18:28	09/12/2020 20:00	09/12/2020 18:28	09/12/2020 20:00	1,53	18	27,49	CHI
20201251296	CAMPOS BELOS	CH21262297	SAO DOMINGOS	09/12/2020 18:28	09/12/2020 22:02	09/12/2020 18:28	09/12/2020 22:02	3,56	1	3,56	CHI
20201251298	ITUMBIARA	IT12000249	ITUMBIARA NOVA	09/12/2020 18:28	10/12/2020 14:00	09/12/2020 18:28	10/12/2020 14:00	19,53	4	78,10	CHI
20201251302	QUIRINOPOLIS	QI21207018	QUIRINOPOLIS	09/12/2020 18:28	11/12/2020 08:49	09/12/2020 18:28	11/12/2020 08:49	38,33	2	76,67	CHI
20201251842	CAIAPONIA	CP12253788	CAIAPONIA	09/12/2020 18:28	10/12/2020 00:21	09/12/2020 18:28	10/12/2020 00:21	5,88	23	135,26	CHI
20201251309	ARENOPOLIS	AY21147496	ARENOPOLIS	09/12/2020 18:29	10/12/2020 13:59	09/12/2020 18:29	10/12/2020 13:59	19,48	1	19,48	CHI
20201251315	VILA PROPICIO	NP12235935	GOIANESIA S1	09/12/2020 18:29	10/12/2020 09:29	09/12/2020 18:29	10/12/2020 09:29	14,99	18	269,74	CHI
20201251828	MINEIROS	MY12348221	PARQUE DAS EMAS	09/12/2020 18:29	09/12/2020 22:08	09/12/2020 18:29	09/12/2020 22:08	3,64	9	32,77	CHI
20201251314	GOIANIA	12371002	CARAJAS S2	09/12/2020 18:30	09/12/2020 21:11	09/12/2020 18:30	09/12/2020 21:11	2,68	1	2,68	CHI
20201251320	GOIANIA	11553078	CAMPINAS S2	09/12/2020 18:31	09/12/2020 21:39	09/12/2020 18:31	09/12/2020 21:39	3,13	1	3,13	CHI
20201251324	GOIANIA	16975704	CAMPINAS S3	09/12/2020 18:31	09/12/2020 21:41	09/12/2020 18:31	09/12/2020 21:41	3,16	1	3,16	CHI
20201251334	COCALZINHO DE GOIAS	ZN11327423	GOIANESIA S1	09/12/2020 18:32	10/12/2020 14:45	09/12/2020 18:32	10/12/2020 14:45	20,21	1	20,21	CHI
20201251338	FORMOSA	610159630	ITUIQUIRA	09/12/2020 18:32	09/12/2020 21:03	09/12/2020 18:32	09/12/2020 21:03	2,51	1	2,51	CHI
20201251348	MINEIROS	MY12303860RE	PARQUE DAS EMAS	09/12/2020 18:34	09/12/2020 21:34	09/12/2020 18:34	09/12/2020 21:34	2,99	7	20,91	CHI
20201252040	VIANOPOLIS	VN12011745	VIANOPOLIS	09/12/2020 18:36	09/12/2020 21:56	09/12/2020 18:36	09/12/2020 21:56	3,33	7	23,31	CHI
20201251362	SANTA HELENA DE GOIAS	SH12296005	ACREUNA	09/12/2020 18:37	10/12/2020 02:06	09/12/2020 18:37	10/12/2020 02:06	7,47	2	14,94	CHI

20201251362	SANTO ANTONIO DA BARRA	SH12296005	ACREUNA	09/12/2020 18:37	10/12/2020 02:06	09/12/2020 18:37	10/12/2020 02:06	7,47	1	7,47	CHI
20201251367	AGUA FRIA DE GOIAS	TL12233976	SAO JOAO D ALIANCA	09/12/2020 18:38	10/12/2020 01:02	09/12/2020 18:38	10/12/2020 01:02	6,40	23	147,16	CHI
20201251389	LUZIANIA	120082172	MARAJOARA	09/12/2020 18:41	09/12/2020 20:02	09/12/2020 18:41	09/12/2020 20:02	1,36	1	1,36	CHI
20201251390	TURVELANDIA	TD12040336	RIO DOS BOIS	09/12/2020 18:41	10/12/2020 10:12	09/12/2020 18:41	10/12/2020 10:12	15,51	1	15,51	CHI
20201251392	OURO VERDE DE GOIAS	OV21137900	PETROLINA	09/12/2020 18:41	10/12/2020 01:38	09/12/2020 18:41	10/12/2020 01:38	6,94	1	6,94	CHI
20201251406	GOIAS	GS21217746	MATRINCHA	09/12/2020 18:43	11/12/2020 08:55	09/12/2020 18:43	11/12/2020 08:55	38,20	1	38,20	CHI
20201251411	JATAI	290229698	JATAI S2	09/12/2020 18:44	09/12/2020 22:32	09/12/2020 18:44	09/12/2020 22:32	3,80	1	3,80	CHI
20201251412	ITAJA	IJ12200688	ITAJA S2	09/12/2020 18:45	09/12/2020 21:15	09/12/2020 18:45	09/12/2020 21:15	2,50	4	9,99	CHI
20201251413	INHUMAS	30003234	INHUMAS S2	09/12/2020 18:45	09/12/2020 21:24	09/12/2020 18:45	09/12/2020 21:24	2,64	1	2,64	CHI
202012179357	CAMPO ALEGRE DE GOIAS	CT13316072	CATALAO S1	09/12/2020 18:45	09/12/2020 21:26	09/12/2020 18:45	09/12/2020 21:26	2,68	3	8,03	CHI
202012179357	CATALAO	CT13316072	CATALAO S1	09/12/2020 18:45	09/12/2020 21:26	09/12/2020 18:45	09/12/2020 21:26	2,68	472	1263,12	CHI
20201251420	ORIZONA	OZ21087381	PIRES DO RIO S2	09/12/2020 18:46	10/12/2020 11:39	09/12/2020 18:46	10/12/2020 11:39	16,88	2	33,77	CHI
20201251423	LUZIANIA	LZ11149862	RIO VERMELHO	09/12/2020 18:46	09/12/2020 23:49	09/12/2020 19:04	09/12/2020 20:05	1,01	188	189,98	CHI
20201251423	LUZIANIA	LZ12149864	RIO VERMELHO	09/12/2020 18:46	09/12/2020 23:49	09/12/2020 23:15	09/12/2020 23:40	0,41	198	81,40	CHI
20201251423	LUZIANIA	LZ11149862	RIO VERMELHO	09/12/2020 18:46	09/12/2020 23:49	09/12/2020 20:46	09/12/2020 23:49	3,04	188	571,73	CHI
20201251428	ITAGUARU	230005536	ITABERAI S1	09/12/2020 18:46	10/12/2020 15:28	09/12/2020 18:46	10/12/2020 15:28	20,68	1	20,68	CHI
20201251430	CIDADE OCIDENTAL	10013681816	MARAJOARA	09/12/2020 18:47	09/12/2020 23:45	09/12/2020 18:47	09/12/2020 23:45	4,96	1	4,96	CHI
20201251432	VALPARAISO DE GOIAS	2860015912	PACAEMBU S1	09/12/2020 18:48	09/12/2020 22:31	09/12/2020 18:48	09/12/2020 22:31	3,72	1	3,72	CHI
20201251433	GOIANIA	12581124	CAMPINAS S2	09/12/2020 18:48	09/12/2020 21:20	09/12/2020 18:48	09/12/2020 21:20	2,53	1	2,53	CHI
20201251436	ANAPOLIS	20150878	JUNDIAI S2	09/12/2020 18:48	10/12/2020 10:59	09/12/2020 18:48	10/12/2020 10:59	16,17	1	16,17	CHI
20201251437	PORANGATU	PO11371078	PORANGATU	09/12/2020 18:48	09/12/2020 21:30	09/12/2020 18:48	09/12/2020 21:30	2,69	9	24,23	CHI
20201251457	FORMOSA	FA31218268	ITUIQUIRA	09/12/2020 18:50	09/12/2020 23:07	09/12/2020 18:50	09/12/2020 23:07	4,28	1	4,28	CHI
20201251476	CACHOEIRA ALTA	CC10251897	CACHOEIRA ALTA	09/12/2020 18:50	09/12/2020 23:01	09/12/2020 18:50	09/12/2020 21:39	2,82	8	22,60	CHI
20201251476	CACU	CC10251897	CACHOEIRA ALTA	09/12/2020 18:50	09/12/2020 23:01	09/12/2020 18:50	09/12/2020 21:39	2,82	1	2,82	CHI
20201251476	CACHOEIRA ALTA	CC10251897	CACHOEIRA ALTA	09/12/2020 18:50	09/12/2020 23:01	09/12/2020 18:50	09/12/2020 22:46	3,94	57	224,77	CHI
20201251476	CACHOEIRA ALTA	CC10251897	CACHOEIRA ALTA	09/12/2020 18:50	09/12/2020 23:01	09/12/2020 18:50	09/12/2020 22:46	3,94	1	3,94	CHI
20201251476	APARECIDA DO RIO DOCE	CC10251897	CACHOEIRA ALTA	09/12/2020 18:50	09/12/2020 23:01	09/12/2020 18:50	09/12/2020 23:01	4,19	636	2664,84	CHI
20201251476	RIO VERDE	CC10251897	CACHOEIRA ALTA	09/12/2020 18:50	09/12/2020 23:01	09/12/2020 18:50	09/12/2020 23:01	4,19	10	41,90	CHI
20201251476	CACHOEIRA ALTA	CC10251897	CACHOEIRA ALTA	09/12/2020 18:50	09/12/2020 23:01	09/12/2020 18:50	09/12/2020 23:01	4,19	3	12,57	CHI
20201251476	RIO VERDE	CC10251897	CACHOEIRA ALTA	09/12/2020 18:50	09/12/2020 23:01	09/12/2020 18:50	09/12/2020 23:01	4,19	7	29,33	CHI
20201251476	CACHOEIRA ALTA	CC10251897	CACHOEIRA ALTA	09/12/2020 18:50	09/12/2020 23:01	09/12/2020 18:50	09/12/2020 23:01	4,19	95	398,05	CHI
20201251476	APARECIDA DO RIO DOCE	CC10251897	CACHOEIRA ALTA	09/12/2020 18:50	09/12/2020 23:01	09/12/2020 18:50	09/12/2020 23:01	4,19	604	2530,76	CHI
20201251476	RIO VERDE	CC10251897	CACHOEIRA ALTA	09/12/2020 18:50	09/12/2020 23:01	09/12/2020 18:50	09/12/2020 23:01	4,19	148	620,12	CHI
20201251476	CACHOEIRA ALTA	CC10251897	CACHOEIRA ALTA	09/12/2020 18:50	09/12/2020 23:01	09/12/2020 18:50	09/12/2020 23:01	4,19	66	276,54	CHI
20201251476	APARECIDA DO RIO DOCE	CC10251897	CACHOEIRA ALTA	09/12/2020 18:50	09/12/2020 23:01	09/12/2020 18:50	09/12/2020 23:01	4,19	25	104,75	CHI
20201251476	JATAI	CC10251897	CACHOEIRA ALTA	09/12/2020 18:50	09/12/2020 23:01	09/12/2020 18:50	09/12/2020 23:01	4,19	34	142,46	CHI
20201251476	RIO VERDE	CC10251897	CACHOEIRA ALTA	09/12/2020 18:50	09/12/2020 23:01	09/12/2020 18:50	09/12/2020 23:01	4,18	1	4,18	CHI
20201251476	RIO VERDE	CC10251897	CACHOEIRA ALTA	09/12/2020 18:50	09/12/2020 23:01	09/12/2020 18:50	09/12/2020 23:01	4,18	2	8,37	CHI
20201251476	APARECIDA DO RIO DOCE	CC10251897	CACHOEIRA ALTA	09/12/2020 18:50	09/12/2020 23:01	09/12/2020 18:50	09/12/2020 23:01	4,18	1	4,18	CHI
20201251476	CACHOEIRA ALTA	CC10251897	CACHOEIRA ALTA	09/12/2020 18:50	09/12/2020 23:01	09/12/2020 18:50	09/12/2020 23:01	4,18	1	4,18	CHI
20201251467	SANTA RITA DO NOVO DESTINO	BA21152783	BARRO ALTO	09/12/2020 18:51	10/12/2020 07:15	09/12/2020 18:51	10/12/2020 07:15	12,39	1	12,39	CHI
20201251473	GOIANIA	10007194925	CARAJAS S2	09/12/2020 18:52	09/12/2020 22:57	09/12/2020 18:52	09/12/2020 22:57	4,08	1	4,08	CHI
20201251491	GOIANIA	14315774	MEIA PONTE	09/12/2020 18:54	09/12/2020 22:23	09/12/2020 18:54	09/12/2020 22:23	3,47	1	3,47	CHI
20201251499	CACHOEIRA ALTA	CA21296665	CACHOEIRA ALTA	09/12/2020 18:54	09/12/2020 19:59	09/12/2020 18:54	09/12/2020 19:59	1,08	3	3,23	CHI
20201251603	CACU	CC11058968	CACHOEIRA ALTA	09/12/2020 18:54	09/12/2020 23:50	09/12/2020 18:54	09/12/2020 23:50	4,93	210	1035,24	CHI
20201251839	FAINA	MS12036227	ITAPURANGA	09/12/2020 18:54	10/12/2020 08:53	09/12/2020 18:54	10/12/2020 08:53	13,98	11	153,75	CHI
20201251839	MORRO AGUDO DE GOIAS	MS12036227	ITAPURANGA	09/12/2020 18:54	10/12/2020 08:53	09/12/2020 18:54	10/12/2020 08:53	13,98	27	377,38	CHI
20201251938	INHUMAS	IN12098279	INHUMAS S1	09/12/2020 18:54	09/12/2020 23:28	09/12/2020 18:54	09/12/2020 23:28	4,55	11	50,07	CHI
20201251507	ITABERAI	IB12018338	ITABERAI S2	09/12/2020 18:56	10/12/2020 10:34	09/12/2020 18:56	10/12/2020 10:34	15,63	4	62,52	CHI
20201251605	CACU	CC11000019	CACHOEIRA ALTA	09/12/2020 18:56	10/12/2020 09:40	09/12/2020 18:56	10/12/2020 09:40	14,72	163	2398,91	CHI
20201251722	CACU	CC11092322	CACHOEIRA ALTA	09/12/2020 18:56	10/12/2020 00:53	09/12/2020 18:56	10/12/2020 00:53	5,94	138	819,72	CHI

20201251810	BONFINOPOLIS	BO11045915	CEPAIGO S2	09/12/2020 18:57	09/12/2020 21:41	09/12/2020 18:57	09/12/2020 21:41	2,72	128	347,91	CHI
20201251532	HIDROLANDIA	HD12400525	CEPAIGO S1	09/12/2020 18:58	10/12/2020 16:20	09/12/2020 18:58	10/12/2020 04:04	9,10	8	72,79	CHI
20201251532	HIDROLANDIA	HD12326261LD	CEPAIGO S1	09/12/2020 18:58	10/12/2020 16:20	09/12/2020 18:58	10/12/2020 16:20	21,36	12	256,29	CHI
20201251533	AGUAS LINDAS DE GOIAS	10025805191	AGUAS LINDAS DE GOIAS S2	09/12/2020 18:58	09/12/2020 21:27	09/12/2020 18:58	09/12/2020 21:27	2,47	1	2,47	CHI
20201251703	ITAPACI	IW11064709	ITAPACI	09/12/2020 18:58	09/12/2020 20:30	09/12/2020 18:58	09/12/2020 20:30	1,53	226	345,09	CHI
20201251717	SILVANIA	SV12087254	DAIA S2	09/12/2020 18:59	09/12/2020 22:40	09/12/2020 18:59	09/12/2020 22:40	3,67	12	44,05	CHI
20201251814	CACU	CC12095406	CACHOEIRA ALTA	09/12/2020 18:59	10/12/2020 00:44	09/12/2020 18:59	10/12/2020 00:44	5,74	200	1147,50	CHI
20201251551	CACU	CC11055296	CACHOEIRA ALTA	09/12/2020 19:00	10/12/2020 03:23	09/12/2020 23:30	10/12/2020 03:23	3,88	100	387,53	CHI
20201251555	BURITI DE GOIAS	BS21324262	FIRMINOPOLIS S2	09/12/2020 19:00	09/12/2020 22:20	09/12/2020 19:00	09/12/2020 22:20	3,32	1	3,32	CHI
20201251737	BONFINOPOLIS	BO11000007	CEPAIGO S2	09/12/2020 19:00	09/12/2020 22:16	09/12/2020 19:00	09/12/2020 22:16	3,26	171	558,03	CHI
20201251559	JATAI	JT21348498	JATAI S1	09/12/2020 19:01	10/12/2020 10:17	09/12/2020 19:01	10/12/2020 10:17	15,26	1	15,26	CHI
20201251567	GOIANIA	10003167320	REAL S2	09/12/2020 19:01	10/12/2020 00:25	09/12/2020 19:01	10/12/2020 00:25	5,39	1	5,39	CHI
20201251692	CACU	CC10394754	CACHOEIRA ALTA	09/12/2020 19:01	10/12/2020 12:33	09/12/2020 19:01	10/12/2020 12:33	17,53	292	5118,68	CHI
20201251692	JATAI	CC10394754	CACHOEIRA ALTA	09/12/2020 19:01	10/12/2020 12:33	09/12/2020 19:01	10/12/2020 12:33	17,53	4	70,12	CHI
20201251692	APARECIDA DO RIO DOCE	CC10394754	CACHOEIRA ALTA	09/12/2020 19:01	10/12/2020 12:33	09/12/2020 19:01	10/12/2020 12:33	17,53	10	175,30	CHI
20201251692	QUIRINOPOLIS	CC10394754	CACHOEIRA ALTA	09/12/2020 19:01	10/12/2020 12:33	09/12/2020 19:01	10/12/2020 12:33	17,53	1	17,53	CHI
20201251692	JATAI	CC10394754	CACHOEIRA ALTA	09/12/2020 19:01	10/12/2020 12:33	09/12/2020 22:45	10/12/2020 12:33	13,80	5	68,98	CHI
20201251581	LUZIANIA	LZ21090967	PAMPLONA	09/12/2020 19:03	10/12/2020 12:21	09/12/2020 19:03	10/12/2020 12:21	17,29	1	17,29	CHI
20201251584	IPORA	730057781	IPORA	09/12/2020 19:03	10/12/2020 08:05	09/12/2020 19:03	10/12/2020 08:05	13,04	1	13,04	CHI
20201251585	IPORA	730089319	IPORA	09/12/2020 19:03	10/12/2020 09:48	09/12/2020 19:03	10/12/2020 09:48	14,74	1	14,74	CHI
20201251593	MORRINHOS	150181644	MORRINHOS	09/12/2020 19:04	09/12/2020 21:08	09/12/2020 19:04	09/12/2020 21:08	2,07	1	2,07	CHI
20201251595	RIO VERDE	RV21136143	SANTA HELENA S1	09/12/2020 19:05	10/12/2020 11:32	09/12/2020 19:05	10/12/2020 11:32	16,44	1	16,44	CHI
20201251596	MONTES CLAROS DE GOIAS	ME12349713	IPORA	09/12/2020 19:06	10/12/2020 17:28	09/12/2020 19:06	10/12/2020 17:28	22,36	1	22,36	CHI
20201251606	PARAUNA	PU12314958	PARAUNA	09/12/2020 19:08	09/12/2020 20:24	09/12/2020 19:08	09/12/2020 20:24	1,26	5	6,31	CHI
20201251606	RIO VERDE	PU12314958	PARAUNA	09/12/2020 19:08	09/12/2020 20:24	09/12/2020 19:08	09/12/2020 20:24	1,26	2	2,52	CHI
20201252015	CACU	CC12131527	CACHOEIRA ALTA	09/12/2020 19:08	10/12/2020 01:05	09/12/2020 19:08	10/12/2020 01:05	5,94	411	2443,05	CHI
20201251636	SENADOR CANEDO	10012097312	SENADOR CANEDO	09/12/2020 19:09	10/12/2020 09:07	09/12/2020 19:09	10/12/2020 09:07	13,96	1	13,96	CHI
20201251641	ARAGUAPAZ	1780017604	MOZARLANDIA	09/12/2020 19:09	10/12/2020 17:53	09/12/2020 19:09	10/12/2020 17:53	22,72	1	22,72	CHI
20201251660	NOVA CRIXAS	NA12349203	NOVA CRIXAS	09/12/2020 19:09	10/12/2020 00:58	09/12/2020 19:09	10/12/2020 00:58	5,81	3	17,42	CHI
20201252018	APARECIDA DE GOIANIA	AP11383878	INDEPENDENCIA S1	09/12/2020 19:09	09/12/2020 22:41	09/12/2020 19:09	09/12/2020 22:41	3,53	42	148,36	CHI
20201251647	GOIANIA	14964405	GOYA S2	09/12/2020 19:10	09/12/2020 22:08	09/12/2020 19:10	09/12/2020 22:08	2,96	1	2,96	CHI
20201251649	BONFINOPOLIS	BO11000008	CEPAIGO S2	09/12/2020 19:10	09/12/2020 22:07	09/12/2020 19:10	09/12/2020 22:07	2,94	186	547,31	CHI
20201251686	CATALAO	CT12399851	CATALAO S1	09/12/2020 19:10	09/12/2020 20:48	09/12/2020 19:10	09/12/2020 20:48	1,63	73	119,13	CHI
20201252013	SAO DOMINGOS	SD12257734	SAO DOMINGOS	09/12/2020 19:11	10/12/2020 09:47	09/12/2020 19:11	10/12/2020 09:47	14,60	57	832,17	CHI
20201251658	ITUMBIARA	CD21097201	BOM JESUS DE GOIAS	09/12/2020 19:12	10/12/2020 13:08	09/12/2020 19:12	10/12/2020 13:08	17,93	1	17,93	CHI
20201251671	NIQUELANDIA	NQ12235663	URUACU	09/12/2020 19:13	09/12/2020 22:57	09/12/2020 19:13	09/12/2020 22:57	3,73	7	26,08	CHI
20201251675	SENADOR CANEDO	10029541946	SENADOR CANEDO	09/12/2020 19:14	10/12/2020 10:59	09/12/2020 19:14	10/12/2020 10:59	15,75	1	15,75	CHI
20201251678	GOIANIA	14835587	CAMPINAS S3	09/12/2020 19:14	09/12/2020 22:57	09/12/2020 19:14	09/12/2020 22:57	3,71	1	3,71	CHI
20201251679	RIO VERDE	RV21260879	CABRIUVA S2	09/12/2020 19:14	10/12/2020 21:07	09/12/2020 19:14	09/12/2020 21:07	1,87	2	3,74	CHI
202012179330	CRISTALINA	KR10400750	CRISTALINA S1	09/12/2020 19:14	10/12/2020 05:50	09/12/2020 21:31	09/12/2020 21:35	0,07	677	44,95	CHI
202012179330	CRISTALINA	KR16410068	CRISTALINA S1	09/12/2020 19:14	10/12/2020 05:50	09/12/2020 19:14	09/12/2020 22:56	3,69	999	3684,09	CHI
202012179330	CRISTALINA	KR16414243	CRISTALINA S1	09/12/2020 19:14	10/12/2020 05:50	09/12/2020 19:14	09/12/2020 22:57	3,71	1221	4527,20	CHI
202012179330	CRISTALINA	KR16409911	CRISTALINA S1	09/12/2020 19:14	10/12/2020 05:50	09/12/2020 19:14	09/12/2020 23:54	4,66	1251	5834,52	CHI
202012179330	CRISTALINA	KR13396443	CRISTALINA S2	09/12/2020 19:14	10/12/2020 05:50	09/12/2020 23:37	09/12/2020 23:55	0,30	13	3,85	CHI
202012179330	IPAMERI	KR13396443	CRISTALINA S2	09/12/2020 19:14	10/12/2020 05:50	09/12/2020 23:37	09/12/2020 23:55	0,30	12	3,55	CHI
202012179330	CRISTALINA	KR11383100	CRISTALINA S1	09/12/2020 19:14	10/12/2020 05:50	09/12/2020 19:14	10/12/2020 04:33	9,31	76	707,56	CHI
202012179330	CRISTALINA	KR16410080	CRISTALINA S1	09/12/2020 19:14	10/12/2020 05:50	09/12/2020 19:14	10/12/2020 05:01	9,77	150	1465,75	CHI
202012179330	CRISTALINA	KR12214949	CRISTALINA S1	09/12/2020 19:14	10/12/2020 05:50	09/12/2020 19:14	10/12/2020 05:01	9,77	312	3048,76	CHI
202012179330	CRISTALINA	00430214	CRISTALINA S1	09/12/2020 19:14	10/12/2020 05:50	09/12/2020 19:54	10/12/2020 05:01	9,10	453	4123,56	CHI
202012179330	CRISTALINA	KR13261593	CRISTALINA S1	09/12/2020 19:14	10/12/2020 05:50	10/12/2020 05:07	10/12/2020 05:15	0,12	3471	411,70	CHI
202012179330	CRISTALINA	KR16409910	CRISTALINA S1	09/12/2020 19:14	10/12/2020 05:50	09/12/2020 19:14	10/12/2020 05:23	10,14	767	7775,04	CHI

202012179330	CRISTALINA	KR13165089	CRISTALINA S2	09/12/2020 19:14	10/12/2020 05:50	10/12/2020 00:37	10/12/2020 05:40	5,05	38	191,74	CHI
202012179330	CRISTALINA	KR13370643B	CRISTALINA S1	09/12/2020 19:14	10/12/2020 05:50	09/12/2020 19:14	10/12/2020 05:50	10,60	242	2564,66	CHI
202012179330	LUZIANIA	KR13370643B	CRISTALINA S1	09/12/2020 19:14	10/12/2020 05:50	09/12/2020 19:14	10/12/2020 05:50	10,60	37	392,12	CHI
202012179330	IPAMERI	KR13370643B	CRISTALINA S1	09/12/2020 19:14	10/12/2020 05:50	09/12/2020 19:14	10/12/2020 05:50	10,60	1282	13586,35	CHI
20201252030	CRISTALINA	KR12206728	PAMPLONA	09/12/2020 19:16	09/12/2020 22:54	09/12/2020 19:16	09/12/2020 22:54	3,62	273	988,18	CHI
20201251700	MARA ROSA	MQ21249313	MARA ROSA	09/12/2020 19:17	09/12/2020 23:03	09/12/2020 19:17	09/12/2020 23:03	3,76	1	3,76	CHI
20201251710	APARECIDA DE GOIANIA	10014101368	INDEPENDENCIA S2	09/12/2020 19:18	10/12/2020 03:15	09/12/2020 19:18	10/12/2020 03:15	7,94	1	7,94	CHI
20201251716	ANAPOLIS	20208133	ANAPOLIS UNIVERSITARIO S2	09/12/2020 19:19	10/12/2020 10:29	09/12/2020 19:19	10/12/2020 10:29	15,16	1	15,16	CHI
20201251720	GOIAS	GS21183456	GOIAS	09/12/2020 19:19	10/12/2020 08:58	09/12/2020 19:19	10/12/2020 08:58	13,63	2	27,27	CHI
20201251726	DIORAMA	DI21065668	IPORA	09/12/2020 19:20	10/12/2020 07:27	09/12/2020 19:20	10/12/2020 07:27	12,11	1	12,11	CHI
20201251801	HIDROLANDIA	HD11006302	CEPAIGO S2	09/12/2020 19:20	09/12/2020 21:46	09/12/2020 19:20	09/12/2020 21:46	2,42	175	424,03	CHI
20201251829	CACU	CC11194916	CACHOEIRA ALTA	09/12/2020 19:20	10/12/2020 01:30	09/12/2020 19:20	10/12/2020 01:30	6,17	132	813,85	CHI
20201251830	GOIANIA	GN11150494	GOYA S2	09/12/2020 19:20	09/12/2020 22:00	09/12/2020 19:20	09/12/2020 22:00	2,66	148	393,39	CHI
20201246553	CORREGO DO OURO	CO21079911	SAO LUIZ DOS MONTES BELOS	09/12/2020 19:22	09/12/2020 21:36	09/12/2020 19:22	09/12/2020 21:36	2,22	1	2,22	CHI
20201251748	MARA ROSA	MQ21277211	MARA ROSA	09/12/2020 19:22	09/12/2020 22:00	09/12/2020 19:22	09/12/2020 22:00	2,63	1	2,63	CHI
20201251753	GOIANIA	13965920	MEIA PONTE	09/12/2020 19:22	10/12/2020 00:29	09/12/2020 19:22	10/12/2020 00:29	5,10	1	5,10	CHI
20201251765	IPORA	730015725	IPORA	09/12/2020 19:23	10/12/2020 04:17	09/12/2020 19:23	10/12/2020 04:17	8,90	1	8,90	CHI
20201251775	SIMOLANDIA	1940013036	IACIARA S2	09/12/2020 19:24	10/12/2020 15:42	09/12/2020 19:24	10/12/2020 15:42	20,29	1	20,29	CHI
20201251776	GOIANIA	13056918	GOYA S2	09/12/2020 19:24	10/12/2020 02:24	09/12/2020 19:24	10/12/2020 02:24	6,99	1	6,99	CHI
20201251777	GUARINOS	GF21314343	SANTA TEREZINHA	09/12/2020 19:24	10/12/2020 10:15	09/12/2020 19:24	10/12/2020 10:15	14,84	1	14,84	CHI
20201251779	CACU	CC12078598	CACHOEIRA ALTA	09/12/2020 19:24	10/12/2020 15:45	09/12/2020 19:24	10/12/2020 15:45	20,34	7	142,39	CHI
20201251780	MINACU	IH11339951	MINACU	09/12/2020 19:24	10/12/2020 19:55	09/12/2020 19:24	10/12/2020 19:55	24,50	2	49,00	CHI
20201252333	JATAI	JT12303025	JATAI S1	09/12/2020 19:24	10/12/2020 08:29	09/12/2020 19:24	10/12/2020 08:29	13,07	7	91,49	CHI
20201251782	LUZIANIA	120093923	RIO VERMELHO	09/12/2020 19:25	09/12/2020 21:39	09/12/2020 19:25	09/12/2020 21:39	2,23	1	2,23	CHI
20201251837	CACU	CC12000096	CACHOEIRA ALTA	09/12/2020 19:25	10/12/2020 01:58	09/12/2020 19:25	10/12/2020 01:58	6,55	5	32,74	CHI
20201251791	SERRANOPOLIS	3000004220	JATAI S1	09/12/2020 19:26	10/12/2020 13:00	09/12/2020 19:26	10/12/2020 13:00	17,55	1	17,55	CHI
20201251794	PARAUNA	PU21088662	PALMEIRAS	09/12/2020 19:26	10/12/2020 10:11	09/12/2020 19:26	10/12/2020 10:11	14,74	1	14,74	CHI
20201251871	SAO JOAO D ALIANCA	JL12314488	SAO JOAO D ALIANCA	09/12/2020 19:27	13/12/2020 01:18	09/12/2020 19:27	12/12/2020 19:02	71,57	3	214,72	CHI
20201251871	SAO JOAO D ALIANCA	JL12314488	SAO JOAO D ALIANCA	09/12/2020 19:27	13/12/2020 01:18	12/12/2020 19:09	12/12/2020 23:19	4,17	3	12,50	CHI
20201251871	SAO JOAO D ALIANCA	JL12314488	SAO JOAO D ALIANCA	09/12/2020 19:27	13/12/2020 01:18	09/12/2020 19:27	12/12/2020 23:47	76,32	2	152,64	CHI
20201251871	SAO JOAO D ALIANCA	JL12314488	SAO JOAO D ALIANCA	09/12/2020 19:27	13/12/2020 01:18	09/12/2020 19:27	13/12/2020 01:18	77,84	3	233,53	CHI
20201251805	ITABERAI	50072912	ITABERAI S2	09/12/2020 19:28	10/12/2020 00:53	09/12/2020 19:28	10/12/2020 00:53	5,41	1	5,41	CHI
20201251815	QUIRINOPOLIS	QI31014252	QUIRINOPOLIS	09/12/2020 19:29	11/12/2020 00:41	09/12/2020 19:29	11/12/2020 00:41	29,18	2	58,37	CHI
20201251822	RIO VERDE	RV21271651	CABRIUVA S2	09/12/2020 19:31	09/12/2020 20:54	09/12/2020 19:31	09/12/2020 20:54	1,38	1	1,38	CHI
20201251834	SILVANIA	660032156	VIANOPOLIS	09/12/2020 19:33	10/12/2020 01:07	09/12/2020 19:33	10/12/2020 01:07	5,56	1	5,56	CHI
20201251835	ITUMBUIARA	IT11263734	CACHOEIRA DOURADA	09/12/2020 19:33	10/12/2020 11:19	09/12/2020 19:33	10/12/2020 11:19	15,76	1	15,76	CHI
20201251853	CABECEIRAS	CW21403584	ITUIQUIRA	09/12/2020 19:35	09/12/2020 22:31	09/12/2020 19:35	09/12/2020 22:31	2,92	1	2,92	CHI
20201251856	AGUAS LINDAS DE GOIAS	10020724851	AGUAS LINDAS DE GOIAS S1	09/12/2020 19:36	10/12/2020 08:41	09/12/2020 19:36	10/12/2020 08:41	13,08	1	13,08	CHI
20201251860	ALEXANIA	AX12313240	ALEXANIA	09/12/2020 19:36	10/12/2020 07:42	09/12/2020 19:36	10/12/2020 07:42	12,09	18	217,56	CHI
20201251924	AGUAS LINDAS DE GOIAS	LA11146691	AGUAS LINDAS DE GOIAS S2	09/12/2020 19:36	09/12/2020 21:13	09/12/2020 19:36	09/12/2020 21:13	1,62	97	156,79	CHI
20201251864	PIRACANJUBA	60023946	PIRACANJUBA	09/12/2020 19:37	10/12/2020 13:03	09/12/2020 19:37	10/12/2020 13:03	17,43	1	17,43	CHI
20201252396	APARECIDA DE GOIANIA	AP11230631	INDEPENDENCIA S2	09/12/2020 19:38	10/12/2020 00:09	09/12/2020 19:38	10/12/2020 00:09	4,51	94	424,33	CHI
20201251894	FORMOSA	FA11197048	ITUIQUIRA	09/12/2020 19:42	09/12/2020 21:55	09/12/2020 19:42	09/12/2020 21:55	2,21	62	137,23	CHI
20201251897	ANAPOLIS	21347700	DAIA S1	09/12/2020 19:43	09/12/2020 22:06	09/12/2020 19:43	09/12/2020 22:06	2,38	1	2,38	CHI
20201251901	TRINDADE	GR31055077	TRINDADE	09/12/2020 19:43	10/12/2020 01:57	09/12/2020 19:43	10/12/2020 01:57	6,22	1	6,22	CHI
20201251908	UIRAPURU	UP12244464	NOVA CRIXAS	09/12/2020 19:44	10/12/2020 12:11	09/12/2020 19:44	10/12/2020 12:11	16,43	24	394,42	CHI
20201251910	MINACU	IH11202508	MINACU	09/12/2020 19:45	10/12/2020 14:49	09/12/2020 19:45	10/12/2020 14:49	19,07	15	285,98	CHI
20201251915	SAO MIGUEL DO ARAGUAIA	SM21141119	SAO MIGUEL DO ARAGUAIA	09/12/2020 19:45	10/12/2020 00:14	09/12/2020 19:45	10/12/2020 00:14	4,47	1	4,47	CHI
20201251923	MORRINHOS	MR21102515	MORRINHOS	09/12/2020 19:46	09/12/2020 21:52	09/12/2020 19:46	09/12/2020 21:52	2,09	1	2,09	CHI
20201251931	GOIANIA	GN11002097	FERROVIARIO S3	09/12/2020 19:48	10/12/2020 01:30	09/12/2020 19:48	10/12/2020 01:30	5,70	121	690,14	CHI
20201251939	GOIANIRA	10017263091	GOIANIRA	09/12/2020 19:49	10/12/2020 08:39	09/12/2020 19:49	10/12/2020 08:39	12,82	1	12,82	CHI

20201251976	GOIANIA	10010319075	GOYA S1	09/12/2020 19:53	10/12/2020 00:40	09/12/2020 19:53	10/12/2020 00:40	4,78	1	4,78	CHI
20201252078	TRINDADE	TR11111550	TRINDADE	09/12/2020 19:54	10/12/2020 06:20	09/12/2020 19:54	10/12/2020 06:20	10,42	183	1907,06	CHI
20201251984	MONTE ALEGRE DE GOIAS	MA12211597	SAO DOMINGOS	09/12/2020 19:55	09/12/2020 21:43	09/12/2020 19:55	09/12/2020 21:43	1,80	10	17,97	CHI
20201251995	GOIANIRA	390103275	MEIA PONTE	09/12/2020 19:56	10/12/2020 04:00	09/12/2020 19:56	10/12/2020 04:00	8,06	1	8,06	CHI
20201252000	GOIANIA	14617950	CARAJAS S1	09/12/2020 19:57	09/12/2020 23:33	09/12/2020 19:57	09/12/2020 23:33	3,59	1	3,59	CHI
20201252003	PORTEIRAO	CL21230802	RIO DOS BOIS	09/12/2020 19:57	10/12/2020 03:07	09/12/2020 19:57	10/12/2020 03:07	7,16	1	7,16	CHI
20201252016	CIDADE OCIDENTAL	10026368364	MARAJOARA	09/12/2020 19:59	10/12/2020 11:02	09/12/2020 19:59	10/12/2020 11:02	15,04	1	15,04	CHI
20201252017	GOIANIA	14459619	GOIANIA LESTE S3	09/12/2020 20:00	09/12/2020 20:58	09/12/2020 20:00	09/12/2020 20:58	0,97	1	0,97	CHI
20201252023	DAMOLANDIA	DL31012286	INHUMAS S1	09/12/2020 20:01	09/12/2020 21:55	09/12/2020 20:01	09/12/2020 21:55	1,89	2	3,77	CHI
20201252079	TEREZOPOLIS DE GOIAS	1370023318	DAIA S2	09/12/2020 20:02	10/12/2020 12:47	09/12/2020 20:02	10/12/2020 12:47	16,74	1	16,74	CHI
20201252034	CATURAI	250006388	INHUMAS S1	09/12/2020 20:04	09/12/2020 23:27	09/12/2020 20:04	09/12/2020 23:27	3,38	1	3,38	CHI
20201252036	LUZIANIA	LZ12433802	VIANOPOLIS	09/12/2020 20:04	10/12/2020 12:08	09/12/2020 20:04	10/12/2020 12:08	16,06	3	48,17	CHI
20201252037	ABADIANIA	AA21254180	ANAPOLIS UNIVERSITARIO S1	09/12/2020 20:04	09/12/2020 21:09	09/12/2020 20:04	09/12/2020 21:09	1,07	1	1,07	CHI
20201252041	CHAPADAO DO CEU	10030573511	CHAPADAO DO CEU	09/12/2020 20:05	10/12/2020 10:55	09/12/2020 20:05	10/12/2020 10:55	14,82	1	14,82	CHI
20201252195	PORANGATU	BX12292422	SAO MIGUEL DO ARAGUAIA	09/12/2020 20:05	10/12/2020 09:15	09/12/2020 20:05	10/12/2020 09:15	13,16	1	13,16	CHI
20201252195	BONOPOLIS	BX12292422	SAO MIGUEL DO ARAGUAIA	09/12/2020 20:05	10/12/2020 09:15	09/12/2020 20:05	10/12/2020 09:15	13,16	32	421,28	CHI
20201252047	CAVALCANTE	CJ12346073	MINACU	09/12/2020 20:07	10/12/2020 13:43	09/12/2020 20:07	10/12/2020 13:43	17,59	124	2180,64	CHI
20201252050	OURO VERDE DE GOIAS	OV12384176	NEROPOLIS S1	09/12/2020 20:08	10/12/2020 12:10	09/12/2020 20:08	10/12/2020 12:10	16,03	11	176,34	CHI
20201252355	CATURAI	CK12015437	INHUMAS S1	09/12/2020 20:08	10/12/2020 13:48	09/12/2020 20:08	10/12/2020 13:48	17,66	13	229,52	CHI
20201252355	GOIANIRA	CK12015437	INHUMAS S1	09/12/2020 20:08	10/12/2020 13:48	09/12/2020 20:08	10/12/2020 13:48	17,66	8	141,24	CHI
20201252054	BRAZABRANTES	10015139547	NEROPOLIS S1	09/12/2020 20:09	10/12/2020 01:54	09/12/2020 20:09	10/12/2020 01:54	5,74	1	5,74	CHI
20201252056	JANDAIA	JD12255748	ACREUNA	09/12/2020 20:09	10/12/2020 11:37	09/12/2020 20:09	10/12/2020 11:37	15,45	1	15,45	CHI
20201252056	ACREUNA	JD12255748	ACREUNA	09/12/2020 20:09	10/12/2020 11:37	09/12/2020 20:09	10/12/2020 11:37	15,45	5	77,26	CHI
20201252057	MORRINHOS	10019268953	MORRINHOS	09/12/2020 20:09	10/12/2020 01:04	09/12/2020 20:09	10/12/2020 01:04	4,91	1	4,91	CHI
20201252385	HIDROLANDIA	HD12366272	CEPAIGO S2	09/12/2020 20:09	09/12/2020 23:14	09/12/2020 20:09	09/12/2020 23:14	3,07	7	21,51	CHI
20201252060	PIRENOPOLIS	PV21070822	CORUMBA	09/12/2020 20:10	09/12/2020 22:54	09/12/2020 20:10	09/12/2020 22:54	2,73	1	2,73	CHI
20201252063	LEOPOLDO DE BULHOES	BO21270651	DAIA S2	09/12/2020 20:10	09/12/2020 23:27	09/12/2020 20:10	09/12/2020 23:27	3,27	2	6,54	CHI
20201252076	GOIAS	GS21171233	GOIAS	09/12/2020 20:12	10/12/2020 13:09	09/12/2020 20:12	10/12/2020 13:09	16,94	1	16,94	CHI
20201252110	GOIANIA	GN12000346	FERROVIARIO S2	09/12/2020 20:12	09/12/2020 21:20	09/12/2020 20:12	09/12/2020 21:20	1,13	116	130,73	CHI
20201252087	IPAMERI	IP21420389	IPAMERI	09/12/2020 20:15	10/12/2020 07:54	09/12/2020 20:15	10/12/2020 07:54	11,64	1	11,64	CHI
20201252949	ITAPIRAPUA	IU12008889	MATRINCHA	09/12/2020 20:16	10/12/2020 12:07	09/12/2020 20:16	10/12/2020 12:07	15,84	9	142,59	CHI
20201252416	ANAPOLIS	AN11000008	ANAPOLIS UNIVERSITARIO S2	09/12/2020 20:17	09/12/2020 23:41	09/12/2020 20:17	09/12/2020 23:41	3,39	76	257,56	CHI
20201252107	PORANGATU	MU12394938	MARA ROSA	09/12/2020 20:20	10/12/2020 11:48	09/12/2020 20:20	10/12/2020 11:48	15,45	26	401,76	CHI
20201252107	MUTUNOPOLIS	MU12394938	MARA ROSA	09/12/2020 20:20	10/12/2020 11:48	09/12/2020 20:20	10/12/2020 11:48	15,45	14	216,33	CHI
20201252107	BONOPOLIS	MU12394938	MARA ROSA	09/12/2020 20:20	10/12/2020 11:48	09/12/2020 20:20	10/12/2020 11:48	15,45	2	30,90	CHI
20201252107	AMARALINA	MU12394938	MARA ROSA	09/12/2020 20:20	10/12/2020 11:48	09/12/2020 20:20	10/12/2020 11:48	15,45	6	92,71	CHI
20201252115	PALMEIRAS DE GOIAS	PL12349319	PALMEIRAS	09/12/2020 20:23	09/12/2020 21:56	09/12/2020 20:23	09/12/2020 21:56	1,55	2	3,10	CHI
20201252121	SAO MIGUEL DO ARAGUAIA	SM21291088	SAO MIGUEL DO ARAGUAIA	09/12/2020 20:23	09/12/2020 23:33	09/12/2020 20:23	09/12/2020 23:33	3,15	1	3,15	CHI
20201252131	CAIAPONIA	CP12269004	CAIAPONIA	09/12/2020 20:25	10/12/2020 08:57	09/12/2020 20:25	10/12/2020 08:57	12,52	5	62,61	CHI
20201252139	EDEIA	EA12257964	EDEIA	09/12/2020 20:26	09/12/2020 22:45	09/12/2020 20:26	09/12/2020 22:45	2,30	1	2,30	CHI
20201252146	SANTA HELENA DE GOIAS	SH12024698	RIO VERDE S1	09/12/2020 20:27	10/12/2020 11:54	09/12/2020 20:27	10/12/2020 11:54	15,44	5	77,21	CHI
20201252313	EDEIA	EA12232936	PONTALINA	09/12/2020 20:27	09/12/2020 23:38	09/12/2020 20:27	09/12/2020 23:38	3,18	23	73,11	CHI
20201252313	EDEALINA	EA12232936	PONTALINA	09/12/2020 20:27	09/12/2020 23:38	09/12/2020 20:27	09/12/2020 23:38	3,18	40	127,16	CHI
20201252151	CIDADE OCIDENTAL	2680037760	MARAJOARA	09/12/2020 20:29	10/12/2020 10:35	09/12/2020 20:29	10/12/2020 10:35	14,10	1	14,10	CHI
20201252156	PALMEIRAS DE GOIAS	PL21195734	PALMEIRAS	09/12/2020 20:29	09/12/2020 22:47	09/12/2020 20:29	09/12/2020 22:47	2,29	1	2,29	CHI
20201252160	BOM JARDIM DE GOIAS	BM21201517	BOM JARDIM	09/12/2020 20:31	10/12/2020 00:33	09/12/2020 20:31	10/12/2020 00:33	4,03	2	8,06	CHI
20201252163	BONOPOLIS	BX12397165	SAO MIGUEL DO ARAGUAIA	09/12/2020 20:31	10/12/2020 08:27	09/12/2020 20:31	10/12/2020 08:27	11,93	4	47,71	CHI
20201252405	SANTA ROSA DE GOIAS	IX12049364	INHUMAS S2	09/12/2020 20:35	10/12/2020 01:27	09/12/2020 20:35	10/12/2020 01:27	4,87	11	53,57	CHI
20201252405	ITAUCU	IX12049364	INHUMAS S2	09/12/2020 20:35	10/12/2020 01:27	09/12/2020 20:35	10/12/2020 01:27	4,87	13	63,31	CHI
20201253257	COLINAS DO SUL	TI12196546RE	MINACU	09/12/2020 20:35	10/12/2020 15:46	09/12/2020 20:35	10/12/2020 15:46	19,18	28	536,92	CHI
20201252176	BELA VISTA DE GOIAS	BV21102407	BELA VISTA S1	09/12/2020 20:36	09/12/2020 22:41	09/12/2020 20:36	09/12/2020 22:41	2,08	1	2,08	CHI

20201252177	FORMOSO	FO12071118	PORANGATU	09/12/2020 20:36	09/12/2020 21:55	09/12/2020 20:36	09/12/2020 21:55	1,30	3	3,91	CHI
20201252182	MUNDO NOVO DE GOIAS	MH12291217LD	NOVA CRIXAS	09/12/2020 20:37	10/12/2020 02:32	09/12/2020 20:37	10/12/2020 02:32	5,90	25	147,51	CHI
20201252185	APARECIDA DE GOIANIA	200194215	CEPAIGO S1	09/12/2020 20:38	09/12/2020 22:48	09/12/2020 20:38	09/12/2020 22:48	2,16	1	2,16	CHI
20201252446	HIDROLANDIA	HD11383822	CEPAIGO S2	09/12/2020 20:39	09/12/2020 23:21	09/12/2020 20:39	09/12/2020 23:21	2,70	58	156,37	CHI
20201252193	PARANAIGUARA	PC12100500	QUIRINOPOLIS	09/12/2020 20:40	10/12/2020 03:27	09/12/2020 20:40	10/12/2020 03:27	6,78	1	6,78	CHI
20201252194	SANTA FE DE GOIAS	RN12138786	BRITANIA	09/12/2020 20:40	10/12/2020 10:51	09/12/2020 20:40	10/12/2020 10:51	14,18	8	113,45	CHI
20201252200	ITARUMA	2310013049	CACHOEIRA ALTA	09/12/2020 20:41	10/12/2020 09:39	09/12/2020 20:41	10/12/2020 09:39	12,95	1	12,95	CHI
20201252261	GOIANIA	GN12099705	CAMPINAS S3	09/12/2020 20:41	09/12/2020 21:57	09/12/2020 20:41	09/12/2020 21:57	1,25	535	670,09	CHI
20201252202	ABADIANIA	AA21184728	ANAPOLIS UNIVERSITARIO S1	09/12/2020 20:42	09/12/2020 23:01	09/12/2020 20:42	09/12/2020 23:01	2,31	1	2,31	CHI
20201252283	SENADOR CANEDO	SW12188859	SENADOR CANEDO	09/12/2020 20:45	09/12/2020 21:56	09/12/2020 20:45	09/12/2020 21:56	1,17	214	250,62	CHI
20201254654	ITAUCU	IX21013767	INHUMAS S2	09/12/2020 20:46	10/12/2020 13:08	09/12/2020 20:46	10/12/2020 13:08	16,35	1	16,35	CHI
20201252825	VILA PROPICIO	PV12102018	GOIANESIA S1	09/12/2020 20:47	10/12/2020 10:02	09/12/2020 20:47	10/12/2020 10:02	13,24	4	52,96	CHI
20201252243	CACU	1140041130	CACHOEIRA ALTA	09/12/2020 20:50	10/12/2020 15:51	09/12/2020 20:50	10/12/2020 15:51	19,00	1	19,00	CHI
20201252256	LUZIANIA	10029705450	VIANOPOLIS	09/12/2020 20:52	10/12/2020 09:51	09/12/2020 20:52	10/12/2020 09:51	12,97	1	12,97	CHI
20201252257	GOIANIA	16934994	CARAJAS S1	09/12/2020 20:52	10/12/2020 01:52	09/12/2020 20:52	10/12/2020 01:52	4,99	1	4,99	CHI
20201252262	FORMOSA	FA21128327	ITIQUEIRA	09/12/2020 20:53	10/12/2020 09:07	09/12/2020 20:53	10/12/2020 09:07	12,22	1	12,22	CHI
20201252264	CRISTALINA	KR12348546RE	PAMPLONA	09/12/2020 20:53	10/12/2020 09:02	09/12/2020 20:53	10/12/2020 09:02	12,15	25	303,69	CHI
20201252267	ITABERAÍ	50051428	ITABERAÍ S2	09/12/2020 20:54	10/12/2020 09:44	09/12/2020 20:54	10/12/2020 09:44	12,82	1	12,82	CHI
20201252296	PIRENOPOLIS	PV12384891	CORUMBA	09/12/2020 20:56	10/12/2020 11:41	09/12/2020 20:56	10/12/2020 11:41	14,75	15	221,23	CHI
20201252275	CACU	CC21018132	CACHOEIRA ALTA	09/12/2020 20:57	10/12/2020 16:39	09/12/2020 20:57	10/12/2020 16:39	19,69	1	19,69	CHI
20201252277	SAO MIGUEL DO ARAGUAIA	SM12059999	SAO MIGUEL DO ARAGUAIA	09/12/2020 20:58	10/12/2020 01:40	09/12/2020 20:58	10/12/2020 01:40	4,70	10	46,98	CHI
20201252364	FORMOSA	FA12404372	ITIQUEIRA	09/12/2020 20:59	09/12/2020 22:49	09/12/2020 20:59	09/12/2020 22:49	1,83	166	303,37	CHI
20201252285	GOIANIA	14417029	GOYA S1	09/12/2020 21:01	09/12/2020 21:47	09/12/2020 21:01	09/12/2020 21:47	0,76	1	0,76	CHI
20201252287	JARAGUA	JA21064335	JARAGUA	09/12/2020 21:01	10/12/2020 11:22	09/12/2020 21:01	10/12/2020 11:22	14,34	1	14,34	CHI
20201252290	GOIANIA	10007420658	GOYA S1	09/12/2020 21:01	10/12/2020 03:04	09/12/2020 21:01	10/12/2020 03:04	6,04	1	6,04	CHI
20201252291	JANDAIA	JD21240451	PALMEIRAS	09/12/2020 21:02	10/12/2020 11:07	09/12/2020 21:02	10/12/2020 11:07	14,08	2	28,16	CHI
20201256085	NOVA CRIXAS	8570018917	NOVA CRIXAS	09/12/2020 21:02	10/12/2020 17:47	09/12/2020 21:02	10/12/2020 17:47	20,74	1	20,74	CHI
20201252299	GOIANIA	15099787	GOYA S2	09/12/2020 21:04	10/12/2020 01:03	09/12/2020 21:04	10/12/2020 01:03	3,98	1	3,98	CHI
20201252300	TEREZOPOLIS DE GOIAS	TJ21353275	DAIA S2	09/12/2020 21:04	10/12/2020 00:23	09/12/2020 21:04	10/12/2020 00:23	3,31	1	3,31	CHI
20201252383	FAINA	FC12124752	GOIAS	09/12/2020 21:04	10/12/2020 09:34	09/12/2020 21:04	10/12/2020 09:34	12,49	27	337,24	CHI
20201252303	GOIANIA	10028791019	CARAJAS S1	09/12/2020 21:05	10/12/2020 02:17	09/12/2020 21:05	10/12/2020 02:17	5,20	1	5,20	CHI
20201252306	FORMOSA	FA11388114	ITIQUEIRA	09/12/2020 21:05	10/12/2020 08:34	09/12/2020 21:05	10/12/2020 08:34	11,47	1	11,47	CHI
20201252386	JANDAIA	JD12024301	PALMEIRAS	09/12/2020 21:05	10/12/2020 10:14	09/12/2020 21:05	10/12/2020 10:14	13,14	9	118,25	CHI
20201252308	PIRACANJUBA	60072118	PIRACANJUBA	09/12/2020 21:06	10/12/2020 13:39	09/12/2020 21:06	10/12/2020 13:39	16,55	1	16,55	CHI
20201252312	FAINA	FC21061050	GOIAS	09/12/2020 21:06	10/12/2020 07:49	09/12/2020 21:06	10/12/2020 07:49	10,70	1	10,70	CHI
20201252356	CRIXAS	CX10403945	SERRA DO OURO	09/12/2020 21:06	11/12/2020 01:35	09/12/2020 21:06	09/12/2020 21:24	0,30	1265	384,42	CHI
20201252356	NOVA CRIXAS	CX10403945	SERRA DO OURO	09/12/2020 21:06	11/12/2020 01:35	09/12/2020 21:06	09/12/2020 21:24	0,30	6	1,82	CHI
20201252356	CRIXAS	CX10403945	SERRA DO OURO	09/12/2020 21:06	11/12/2020 01:35	09/12/2020 21:06	09/12/2020 21:24	0,29	3	0,88	CHI
20201252356	CRIXAS	CX10403945	SERRA DO OURO	09/12/2020 21:06	11/12/2020 01:35	09/12/2020 21:06	09/12/2020 23:08	2,03	1122	2282,34	CHI
20201252356	CRIXAS	CX16410840	SERRA DO OURO	09/12/2020 21:06	11/12/2020 01:35	09/12/2020 23:45	09/12/2020 23:53	0,14	1122	158,01	CHI
20201252356	CRIXAS	CX16405210	SERRA DO OURO	09/12/2020 21:06	11/12/2020 01:35	09/12/2020 21:06	09/12/2020 23:54	2,80	689	1930,73	CHI
20201252356	CRIXAS	CX10403945	SERRA DO OURO	09/12/2020 21:06	11/12/2020 01:35	09/12/2020 21:06	10/12/2020 08:12	11,10	44	488,60	CHI
20201252356	CRIXAS	CX10403945	SERRA DO OURO	09/12/2020 21:06	11/12/2020 01:35	09/12/2020 21:06	10/12/2020 09:47	12,69	52	659,94	CHI
20201252356	NOVA CRIXAS	00450214	SERRA DO OURO	09/12/2020 21:06	11/12/2020 01:35	10/12/2020 09:48	10/12/2020 10:34	0,76	6	4,54	CHI
20201252356	CRIXAS	00450214	SERRA DO OURO	09/12/2020 21:06	11/12/2020 01:35	10/12/2020 09:48	10/12/2020 10:34	0,76	4537	3434,26	CHI
20201252356	CRIXAS	CX13243592	SERRA DO OURO	09/12/2020 21:06	11/12/2020 01:35	10/12/2020 09:48	10/12/2020 20:22	10,55	52	548,67	CHI
20201252356	PORANGATU	CX10403945	SERRA DO OURO	09/12/2020 21:06	11/12/2020 01:35	09/12/2020 21:06	11/12/2020 01:35	28,48	1	28,48	CHI
20201252356	NOVA ROMA	CX10403945	SERRA DO OURO	09/12/2020 21:06	11/12/2020 01:35	09/12/2020 21:06	11/12/2020 01:35	28,48	1	28,48	CHI
20201252356	CRIXAS	CX10403945	SERRA DO OURO	09/12/2020 21:06	11/12/2020 01:35	09/12/2020 21:06	11/12/2020 01:35	28,48	270	7690,05	CHI
20201252356	CRIXAS	CX13145558	SERRA DO OURO	09/12/2020 21:06	11/12/2020 01:35	09/12/2020 21:22	11/12/2020 01:35	28,21	2	56,42	CHI
20201252325	CALDAS NOVAS	CN11037876	SERRA DE CALDAS	09/12/2020 21:07	10/12/2020 02:49	09/12/2020 21:07	10/12/2020 02:49	5,69	218	1240,18	CHI

20201255299	MINACU	IH12242190	MINACU	09/12/2020 21:07	11/12/2020 00:32	09/12/2020 21:07	11/12/2020 00:32	27,41	1	27,41	CHI
20201252320	NOVO BRASIL	10013965903	JUSSARA	09/12/2020 21:08	10/12/2020 09:10	09/12/2020 21:08	10/12/2020 09:10	12,03	1	12,03	CHI
20201252328	JATAI	JT12303855	JATAI S1	09/12/2020 21:10	10/12/2020 15:04	09/12/2020 21:10	10/12/2020 15:04	17,89	7	125,21	CHI
20201252337	INHUMAS	IN21244938	INHUMAS S2	09/12/2020 21:13	10/12/2020 02:41	09/12/2020 21:13	10/12/2020 02:41	5,46	1	5,46	CHI
20201252340	JATAI	JT12241740	JATAI S1	09/12/2020 21:14	10/12/2020 12:44	09/12/2020 21:14	10/12/2020 12:44	15,50	1	15,50	CHI
20201252343	AMARALINA	LC11276187	SAO MIGUEL DO ARAGUAIA	09/12/2020 21:14	10/12/2020 13:37	09/12/2020 21:14	10/12/2020 13:37	16,37	1	16,37	CHI
20201252349	VICENTINOPOLIS	VI21028520	VICENTINOPOLIS	09/12/2020 21:16	10/12/2020 14:55	09/12/2020 21:16	10/12/2020 14:55	17,64	1	17,64	CHI
20201252350	GOIANIA	10349169	CAMPINAS S1	09/12/2020 21:16	10/12/2020 05:29	09/12/2020 21:16	10/12/2020 05:29	8,21	1	8,21	CHI
20201252352	BONFINOPOLIS	TA12247490	NOVO PLANALTO	09/12/2020 21:16	10/12/2020 01:07	09/12/2020 21:16	10/12/2020 01:07	3,83	1	3,83	CHI
20201252352	BONOPOLIS	TA12247490	NOVO PLANALTO	09/12/2020 21:16	10/12/2020 01:07	09/12/2020 21:16	10/12/2020 01:07	3,83	11	42,18	CHI
20201252352	PORANGATU	TA12247490	NOVO PLANALTO	09/12/2020 21:16	10/12/2020 01:07	09/12/2020 21:16	10/12/2020 01:07	3,83	2	7,67	CHI
20201252362	ABADIA DE GOIAS	AO12007317	INDEPENDENCIA S2	09/12/2020 21:20	10/12/2020 01:06	09/12/2020 21:20	10/12/2020 01:06	3,76	2	7,52	CHI
20201252363	CAIAPONIA	CP12248981	CAIAPONIA	09/12/2020 21:21	11/12/2020 10:46	09/12/2020 21:21	11/12/2020 10:46	37,42	8	299,36	CHI
20201252367	FORMOSA	610114979	ITUIQUIRA	09/12/2020 21:21	09/12/2020 22:44	09/12/2020 21:21	09/12/2020 22:44	1,38	1	1,38	CHI
20201252374	GOIANIA	10006550094	GOYA S1	09/12/2020 21:24	10/12/2020 05:05	09/12/2020 21:24	10/12/2020 05:05	7,67	1	7,67	CHI
20201252377	ALEXANIA	10001559050	ALEXANIA	09/12/2020 21:25	10/12/2020 18:27	09/12/2020 21:25	10/12/2020 18:27	21,02	1	21,02	CHI
20201252380	LEOPOLDO DE BULHOES	LB11200587	DAIA S2	09/12/2020 21:26	10/12/2020 00:25	09/12/2020 21:26	10/12/2020 00:25	2,98	75	223,15	CHI
20201252392	GAUPO	GA12022424	INDEPENDENCIA S2	09/12/2020 21:29	10/12/2020 03:06	09/12/2020 21:29	10/12/2020 03:06	5,60	9	50,41	CHI
20201252393	ALEXANIA	AX12196986	ALEXANIA	09/12/2020 21:29	10/12/2020 10:52	09/12/2020 21:29	10/12/2020 10:52	13,37	1	13,37	CHI
20201252464	GOIANESIA	GE12256009RE	GOIANESIA S1	09/12/2020 21:29	10/12/2020 01:50	09/12/2020 21:29	10/12/2020 01:50	4,34	18	78,20	CHI
20201252464	SANTA RITA DO NOVO DESTINO	GE12256009RE	GOIANESIA S1	09/12/2020 21:29	10/12/2020 01:50	09/12/2020 21:29	10/12/2020 01:50	4,34	28	121,64	CHI
20201252464	BARRO ALTO	GE12256009RE	GOIANESIA S1	09/12/2020 21:29	10/12/2020 01:50	09/12/2020 21:29	10/12/2020 01:50	4,34	1	4,34	CHI
20201252777	IPAMERI	IP12112268	PIRES DO RIO S2	09/12/2020 21:29	10/12/2020 13:16	09/12/2020 21:29	10/12/2020 13:16	15,77	20	315,50	CHI
20201252397	ALEXANIA	AX12353458	ALEXANIA	09/12/2020 21:30	10/12/2020 09:17	09/12/2020 21:30	10/12/2020 09:17	11,77	17	200,07	CHI
20201252451	JATAI	JT12324674	JATAI S2	09/12/2020 21:30	10/12/2020 04:43	09/12/2020 21:30	10/12/2020 04:43	7,21	14	100,89	CHI
20201252398	MORRINHOS	MR21119716	MORRINHOS	09/12/2020 21:31	09/12/2020 23:38	09/12/2020 21:31	09/12/2020 23:38	2,11	1	2,11	CHI
20201252399	APARECIDA DE GOIANIA	10004382011	INDEPENDENCIA S1	09/12/2020 21:31	09/12/2020 22:09	09/12/2020 21:31	09/12/2020 22:09	0,62	1	0,62	CHI
20201252400	LUZIANIA	LZ12261750	CRISTALINA S2	09/12/2020 21:32	10/12/2020 09:09	09/12/2020 21:32	10/12/2020 09:09	11,61	6	69,68	CHI
20201252401	PIRACANJUBA	PJ21182621	PIRACANJUBA	09/12/2020 21:32	09/12/2020 23:38	09/12/2020 21:32	09/12/2020 23:38	2,08	1	2,08	CHI
20201252404	FORMOSA	FA11397704	ITUIQUIRA	09/12/2020 21:34	09/12/2020 23:06	09/12/2020 21:34	09/12/2020 23:06	1,52	1	1,52	CHI
20201252407	APARECIDA DE GOIANIA	12762787	REAL S2	09/12/2020 21:35	09/12/2020 23:47	09/12/2020 21:35	09/12/2020 23:47	2,19	1	2,19	CHI
20201252408	MINEIROS	MY11347879	PARQUE DAS EMAS	09/12/2020 21:37	10/12/2020 14:20	09/12/2020 21:37	10/12/2020 14:20	16,72	1	16,72	CHI
20201252414	GOIANIA	10010369196	GOYA S1	09/12/2020 21:42	10/12/2020 04:30	09/12/2020 21:42	10/12/2020 04:30	6,79	1	6,79	CHI
20201253264	SERRANOPOLIS	SX12166103	JATAI S1	09/12/2020 21:44	10/12/2020 17:12	09/12/2020 21:44	10/12/2020 17:12	19,46	5	97,28	CHI
20201252586	BURITI DE GOIAS	CO12048391	FIRMINOPOLIS S2	09/12/2020 21:45	10/12/2020 03:04	09/12/2020 21:45	10/12/2020 03:04	5,30	28	148,45	CHI
20201252782	COCALZINHO DE GOIAS	ZN12273292	COCALZINHO	09/12/2020 21:47	10/12/2020 16:42	09/12/2020 21:47	10/12/2020 16:42	18,91	4	75,63	CHI
20201253092	MINEIROS	MY12197099	PARQUE DAS EMAS	09/12/2020 21:47	10/12/2020 09:07	09/12/2020 21:47	10/12/2020 09:07	11,32	9	101,87	CHI
20201252440	VALPARAISO DE GOIAS	10006893943	PACAEMBU S2	09/12/2020 21:51	10/12/2020 01:42	09/12/2020 21:51	10/12/2020 01:42	3,83	1	3,83	CHI
20201253128	JATAI	JT12226486	JATAI S1	09/12/2020 21:52	10/12/2020 08:21	09/12/2020 21:52	10/12/2020 08:21	10,47	28	293,28	CHI
20201252444	NIQUELANDIA	NQ21317641	BARRO ALTO	09/12/2020 21:53	10/12/2020 03:56	09/12/2020 21:53	10/12/2020 03:56	6,04	1	6,04	CHI
20201252450	JARAGUA	JA21039348	GOIANESIA S2	09/12/2020 21:55	10/12/2020 21:50	09/12/2020 21:55	10/12/2020 21:50	23,90	1	23,90	CHI
20201252458	PIRES DO RIO	PR11348270	PIRES DO RIO S1	09/12/2020 21:55	10/12/2020 04:22	09/12/2020 21:55	10/12/2020 04:22	6,43	122	784,97	CHI
20201252452	APARECIDA DE GOIANIA	200432898	INDEPENDENCIA S1	09/12/2020 21:56	09/12/2020 23:01	09/12/2020 21:56	09/12/2020 23:01	1,07	1	1,07	CHI
20201252709	CATALAO	GD12127538	CATALAO S1	09/12/2020 21:56	10/12/2020 07:44	09/12/2020 21:56	10/12/2020 07:44	9,79	6	58,72	CHI
20201252709	GOIANDIRA	GD12127538	CATALAO S1	09/12/2020 21:56	10/12/2020 07:44	09/12/2020 21:56	10/12/2020 07:44	9,79	13	127,23	CHI
20201252455	FLORES DE GOIAS	FB12384211	IACIARA S2	09/12/2020 21:57	09/12/2020 22:42	09/12/2020 21:57	09/12/2020 22:42	0,75	130	96,99	CHI
20201252455	FORMOSA	FB12384211	IACIARA S2	09/12/2020 21:57	09/12/2020 22:42	09/12/2020 21:57	09/12/2020 22:42	0,75	1	0,75	CHI
20201252455	VILA BOA	FB12384211	IACIARA S2	09/12/2020 21:57	09/12/2020 22:42	09/12/2020 21:57	09/12/2020 22:42	0,75	3	2,24	CHI
20201252462	CACU	1140013157	CACHOEIRA ALTA	09/12/2020 22:01	10/12/2020 17:08	09/12/2020 22:01	10/12/2020 17:08	19,11	1	19,11	CHI
20201252465	ESTRELA DO NORTE	ET12168852	MARA ROSA	09/12/2020 22:03	10/12/2020 09:41	09/12/2020 22:03	10/12/2020 09:41	11,62	4	46,47	CHI
20201252465	FORMOSO	ET12168852	MARA ROSA	09/12/2020 22:03	10/12/2020 09:41	09/12/2020 22:03	10/12/2020 09:41	11,62	2	23,23	CHI

20201253431	IACIARA	GY12180835	IACIARA S1	09/12/2020 22:05	10/12/2020 09:31	09/12/2020 22:05	10/12/2020 09:31	11,43	2	22,86	CHI
20201253431	GUARANI DE GOIAS	GY12180835	IACIARA S1	09/12/2020 22:05	10/12/2020 09:31	09/12/2020 22:05	10/12/2020 09:31	11,43	337	3852,38	CHI
20201252472	JARAGUA	JA21339843	JARAGUA	09/12/2020 22:07	10/12/2020 22:13	09/12/2020 22:07	10/12/2020 22:13	24,09	1	24,09	CHI
20201252501	ANAPOLIS	21240127	JUNDIAI S2	09/12/2020 22:11	10/12/2020 16:15	09/12/2020 22:11	10/12/2020 16:15	18,05	1	18,05	CHI
20201253675	JANDAIA	JD12308473	PALMEIRAS	09/12/2020 22:13	10/12/2020 12:43	09/12/2020 22:13	10/12/2020 12:43	14,49	7	101,46	CHI
20201252509	RIO VERDE	RV12271650	CABRIUVA S2	09/12/2020 22:14	09/12/2020 22:47	09/12/2020 22:14	09/12/2020 22:47	0,55	1	0,55	CHI
20201252510	ITUMBIARA	690217330	PARANAIBA	09/12/2020 22:15	10/12/2020 11:00	09/12/2020 22:15	10/12/2020 11:00	12,74	1	12,74	CHI
20201253714	SANTA BARBARA DE GOIAS	SB12000078	TRINDADE	09/12/2020 22:15	10/12/2020 10:31	09/12/2020 22:15	10/12/2020 10:31	12,26	4	49,04	CHI
20201252520	ITUMBIARA	690343164	ITUMBIARA VELHA S1	09/12/2020 22:30	10/12/2020 09:35	09/12/2020 22:30	10/12/2020 09:35	11,08	1	11,08	CHI
20201252521	CALDAS NOVAS	10001809588	CALDAS NOVAS S1	09/12/2020 22:32	10/12/2020 07:38	09/12/2020 22:32	10/12/2020 07:38	9,10	1	9,10	CHI
20201253035	IPAMERI	IP12404711	IPAMERI	09/12/2020 22:32	10/12/2020 09:36	09/12/2020 22:32	10/12/2020 09:36	11,06	89	984,66	CHI
20201253035	CATALAO	IP12404711	IPAMERI	09/12/2020 22:32	10/12/2020 09:36	09/12/2020 22:32	10/12/2020 09:36	11,06	7	77,45	CHI
20201253035	GOIANDIRA	IP12404711	IPAMERI	09/12/2020 22:32	10/12/2020 09:36	09/12/2020 22:32	10/12/2020 09:36	11,06	15	165,95	CHI
20201253019	PIRANHAS	PH12259516	CAIAPONIA	09/12/2020 22:33	10/12/2020 08:50	09/12/2020 22:33	10/12/2020 08:50	10,27	70	718,82	CHI
20201253019	CAIAPONIA	PH12259516	CAIAPONIA	09/12/2020 22:33	10/12/2020 08:50	09/12/2020 22:33	10/12/2020 08:50	10,27	3	30,81	CHI
20201252527	CRISTALINA	10022475247	CRISTALINA S1	09/12/2020 22:34	10/12/2020 10:12	09/12/2020 22:34	10/12/2020 10:12	11,62	1	11,62	CHI
20201252774	CAIAPONIA	CP12155495	CAIAPONIA	09/12/2020 22:34	10/12/2020 07:22	09/12/2020 22:34	10/12/2020 07:22	8,80	10	87,95	CHI
20201252528	MONTE ALEGRE DE GOIAS	MA12211597	SAO DOMINGOS	09/12/2020 22:35	10/12/2020 01:02	09/12/2020 22:35	10/12/2020 01:02	2,44	10	24,39	CHI
20201252889	ITABERAI	IB12274270	ITABERAI S1	09/12/2020 22:39	10/12/2020 08:43	09/12/2020 22:39	10/12/2020 08:43	10,06	48	482,97	CHI
20201252533	LUZIANIA	LZ21313650	MARAJOARA	09/12/2020 22:40	10/12/2020 00:44	09/12/2020 22:40	10/12/2020 00:44	2,06	1	2,06	CHI
20201253941	ALEXANIA	AX12351026	ALEXANIA	09/12/2020 22:43	10/12/2020 11:35	09/12/2020 22:43	10/12/2020 11:35	12,86	78	1002,91	CHI
20201252555	GOIAS	GS12250578	ITABERAI S1	09/12/2020 22:47	10/12/2020 11:58	09/12/2020 22:47	10/12/2020 11:58	13,17	3	39,50	CHI
20201253684	JARAGUA	SR12019009	INHUMAS S1	09/12/2020 22:47	10/12/2020 11:06	09/12/2020 22:47	10/12/2020 11:06	12,31	2	24,62	CHI
20201253684	TAQUARAL DE GOIAS	SR12019009	INHUMAS S1	09/12/2020 22:47	10/12/2020 11:06	09/12/2020 22:47	10/12/2020 11:06	12,31	45	553,90	CHI
20201253684	SANTA ROSA DE GOIAS	SR12019009	INHUMAS S1	09/12/2020 22:47	10/12/2020 11:06	09/12/2020 22:47	10/12/2020 11:06	12,31	66	812,39	CHI
20201252565	GOIAS	90093513	GOIAS	09/12/2020 22:57	10/12/2020 11:42	09/12/2020 22:57	10/12/2020 11:42	12,74	1	12,74	CHI
202012133122	RIO VERDE	RV21160767	RIO VERDE S1	09/12/2020 22:57	10/12/2020 16:30	09/12/2020 22:57	10/12/2020 16:30	17,55	1	17,55	CHI
20201252566	GUARINOS	GF12147945	ITAPACI	09/12/2020 22:59	10/12/2020 15:37	09/12/2020 22:59	10/12/2020 15:37	16,63	17	282,76	CHI
20201252566	ITAPACI	GF12147945	ITAPACI	09/12/2020 22:59	10/12/2020 15:37	09/12/2020 22:59	10/12/2020 15:37	16,63	2	33,27	CHI
20201252582	CACHOEIRA ALTA	00270434	CACHOEIRA ALTA	09/12/2020 23:01	10/12/2020 02:13	09/12/2020 23:01	10/12/2020 01:50	2,82	8	22,55	CHI
20201252582	CACU	00270434	CACHOEIRA ALTA	09/12/2020 23:01	10/12/2020 02:13	09/12/2020 23:01	10/12/2020 01:50	2,82	3	8,46	CHI
20201252582	ITAJA	00270434	CACHOEIRA ALTA	09/12/2020 23:01	10/12/2020 02:13	09/12/2020 23:01	10/12/2020 02:13	3,19	31	99,03	CHI
20201252582	ITARUMA	00270434	CACHOEIRA ALTA	09/12/2020 23:01	10/12/2020 02:13	09/12/2020 23:01	10/12/2020 02:13	3,19	130	415,28	CHI
20201252582	ITARUMA	00270434	CACHOEIRA ALTA	09/12/2020 23:01	10/12/2020 02:13	09/12/2020 23:01	10/12/2020 02:13	3,19	6	19,17	CHI
20201252582	CACU	00270434	CACHOEIRA ALTA	09/12/2020 23:01	10/12/2020 02:13	09/12/2020 23:01	10/12/2020 02:13	3,19	4	12,78	CHI
20201252582	LAGOA SANTA	00270434	CACHOEIRA ALTA	09/12/2020 23:01	10/12/2020 02:13	09/12/2020 23:01	10/12/2020 02:13	3,19	17	54,31	CHI
20201252582	CACU	00270434	CACHOEIRA ALTA	09/12/2020 23:01	10/12/2020 02:13	09/12/2020 23:01	10/12/2020 02:13	3,19	52	166,11	CHI
20201252582	LAGOA SANTA	00270434	CACHOEIRA ALTA	09/12/2020 23:01	10/12/2020 02:13	09/12/2020 23:01	10/12/2020 02:13	3,19	3	9,58	CHI
20201252582	ITARUMA	00270434	CACHOEIRA ALTA	09/12/2020 23:01	10/12/2020 02:13	09/12/2020 23:01	10/12/2020 02:13	3,19	44	140,56	CHI
20201252582	ITAJA	00270434	CACHOEIRA ALTA	09/12/2020 23:01	10/12/2020 02:13	09/12/2020 23:01	10/12/2020 02:13	3,19	7	22,36	CHI
20201252582	ITARUMA	00270434	CACHOEIRA ALTA	09/12/2020 23:01	10/12/2020 02:13	09/12/2020 23:01	10/12/2020 02:13	3,19	78	249,17	CHI
20201252582	ITAJA	00270434	CACHOEIRA ALTA	09/12/2020 23:01	10/12/2020 02:13	09/12/2020 23:01	10/12/2020 02:13	3,19	41	130,97	CHI
20201252582	ITAJA	00270434	CACHOEIRA ALTA	09/12/2020 23:01	10/12/2020 02:13	09/12/2020 23:01	10/12/2020 02:13	3,19	3	9,58	CHI
20201252582	ITAJA	00270434	CACHOEIRA ALTA	09/12/2020 23:01	10/12/2020 02:13	09/12/2020 23:01	10/12/2020 02:13	3,19	15	47,92	CHI
20201252582	ITARUMA	00270434	CACHOEIRA ALTA	09/12/2020 23:01	10/12/2020 02:13	09/12/2020 23:02	10/12/2020 02:13	3,19	1	3,19	CHI
20201252582	ITARUMA	00270434	CACHOEIRA ALTA	09/12/2020 23:01	10/12/2020 02:13	09/12/2020 23:02	10/12/2020 02:13	3,19	3	9,56	CHI
20201252582	CACU	00270434	CACHOEIRA ALTA	09/12/2020 23:01	10/12/2020 02:13	09/12/2020 23:02	10/12/2020 02:13	3,19	3	9,56	CHI
20201252582	CACU	00270434	CACHOEIRA ALTA	09/12/2020 23:01	10/12/2020 02:13	10/12/2020 01:58	10/12/2020 02:13	0,24	3	0,73	CHI
20201252582	CACHOEIRA ALTA	00270434	CACHOEIRA ALTA	09/12/2020 23:01	10/12/2020 02:13	10/12/2020 01:58	10/12/2020 02:13	0,24	8	1,95	CHI
20201252571	JATAI	JT12324906	JATAI S1	09/12/2020 23:06	10/12/2020 11:17	09/12/2020 23:06	10/12/2020 11:17	12,18	7	85,24	CHI
20201252572	BURITI DE GOIAS	BS12079946	FIRMINOPOLIS S2	09/12/2020 23:07	10/12/2020 07:44	09/12/2020 23:07	10/12/2020 07:44	8,60	3	25,81	CHI

20201252579	CACU	1140044970	CACHOEIRA ALTA	09/12/2020 23:14	10/12/2020 12:41	09/12/2020 23:14	10/12/2020 12:41	13,43	1	13,43	CHI
20201252585	NOVO GAMA	2900015255	MARAJOARA	09/12/2020 23:20	10/12/2020 09:24	09/12/2020 23:20	10/12/2020 09:24	10,07	1	10,07	CHI
20201252599	GOIATUBA	JV21157813	GOIATUBA S1	09/12/2020 23:31	10/12/2020 21:04	09/12/2020 23:31	10/12/2020 21:04	21,55	1	21,55	CHI
20201252606	RIO VERDE	630396309	RIO VERDE S2	09/12/2020 23:45	10/12/2020 10:16	09/12/2020 23:45	10/12/2020 10:16	10,51	1	10,51	CHI
20201252608	CATALAO	CT11000060	CATALAO S2	09/12/2020 23:50	10/12/2020 08:31	09/12/2020 23:50	10/12/2020 08:31	8,68	28	243,02	CHI
20201252619	CALDAS NOVAS	CN12213855	SERRA DE CALDAS	09/12/2020 23:50	10/12/2020 04:09	09/12/2020 23:50	10/12/2020 04:09	4,32	96	414,35	CHI
20201252610	ANAPOLIS	AN11398566	ANAPOLIS UNIVERSITARIO S2	09/12/2020 23:54	10/12/2020 04:24	09/12/2020 23:54	10/12/2020 04:24	4,49	87	391,04	CHI
20201252620	SAO SIMAO	SO11073811	CACHOEIRA ALTA	10/12/2020 00:05	10/12/2020 12:21	10/12/2020 00:05	10/12/2020 12:21	12,26	11	134,89	CHI
20201252849	ORIZONA	OZ12084921RE	PIRES DO RIO S2	10/12/2020 00:05	10/12/2020 19:42	10/12/2020 00:05	10/12/2020 12:43	12,63	31	391,40	CHI
20201252849	VIANOPOLIS	OZ12084921RE	PIRES DO RIO S2	10/12/2020 00:05	10/12/2020 19:42	10/12/2020 00:05	10/12/2020 12:43	12,63	8	101,01	CHI
20201252849	ORIZONA	OZ12084921RE	PIRES DO RIO S2	10/12/2020 00:05	10/12/2020 19:42	10/12/2020 00:05	10/12/2020 14:02	13,94	25	348,58	CHI
20201252849	VIANOPOLIS	OZ12084921RE	PIRES DO RIO S2	10/12/2020 00:05	10/12/2020 19:42	10/12/2020 00:05	10/12/2020 14:02	13,94	9	125,49	CHI
20201252849	ORIZONA	OZ12125035LD	PIRES DO RIO S2	10/12/2020 00:05	10/12/2020 19:42	10/12/2020 00:05	10/12/2020 14:02	13,94	1	13,94	CHI
20201252849	ORIZONA	OZ12084921RE	PIRES DO RIO S2	10/12/2020 00:05	10/12/2020 19:42	10/12/2020 00:05	10/12/2020 18:02	17,94	19	340,94	CHI
20201252849	ORIZONA	OZ12085001LD	PIRES DO RIO S2	10/12/2020 00:05	10/12/2020 19:42	10/12/2020 10:33	10/12/2020 18:02	7,48	1	7,48	CHI
20201252849	ORIZONA	OZ12084921RE	PIRES DO RIO S2	10/12/2020 00:05	10/12/2020 19:42	10/12/2020 00:05	10/12/2020 19:04	18,99	10	189,88	CHI
20201252849	ORIZONA	OZ12084921RE	PIRES DO RIO S2	10/12/2020 00:05	10/12/2020 19:42	10/12/2020 00:05	10/12/2020 19:42	19,62	23	451,30	CHI
20201252627	PORANGATU	PO12141125	NOVO PLANALTO	10/12/2020 00:21	10/12/2020 03:06	10/12/2020 00:21	10/12/2020 03:06	2,75	13	35,71	CHI
20201253602	APARECIDA DO RIO DOCE	AW12189038	CACHOEIRA ALTA	10/12/2020 00:31	10/12/2020 11:56	10/12/2020 00:31	10/12/2020 11:56	11,40	5	57,01	CHI
20201248142	JUSSARA	JR12019314	JUSSARA	10/12/2020 00:38	10/12/2020 08:43	10/12/2020 00:38	10/12/2020 08:43	8,07	83	669,69	CHI
20201252939	ARAGUAPAZ	RB12022187	ITAPURANGA	10/12/2020 00:41	10/12/2020 09:05	10/12/2020 00:41	10/12/2020 09:05	8,39	1	8,39	CHI
20201252939	MORRO AGUDO DE GOIAS	RB12022187	ITAPURANGA	10/12/2020 00:41	10/12/2020 09:05	10/12/2020 00:41	10/12/2020 09:05	8,39	1	8,39	CHI
20201252939	RUBIATABA	RB12022187	ITAPURANGA	10/12/2020 00:41	10/12/2020 09:05	10/12/2020 00:41	10/12/2020 09:05	8,39	9	75,47	CHI
20201252635	MINACU	4020077412	MINACU	10/12/2020 00:50	10/12/2020 04:32	10/12/2020 00:50	10/12/2020 04:32	3,69	1	3,69	CHI
20201252637	INHUMAS	IN12272280	INHUMAS S1	10/12/2020 00:53	10/12/2020 08:54	10/12/2020 00:53	10/12/2020 08:54	8,02	30	240,48	CHI
20201252639	BALIZA	BM12208954	BOM JARDIM	10/12/2020 00:59	10/12/2020 04:58	10/12/2020 00:59	10/12/2020 04:58	3,98	7	27,84	CHI
20201252649	NAZARIO	NZ21076353	ANICUNS	10/12/2020 01:03	10/12/2020 08:46	10/12/2020 01:03	10/12/2020 08:46	7,70	4	30,80	CHI
20201252652	PORANGATU	PO12350106	PORANGATU	10/12/2020 01:10	10/12/2020 12:28	10/12/2020 01:10	10/12/2020 12:28	11,30	7	79,13	CHI
20201252836	IPAMERI	IP12404729	IPAMERI	10/12/2020 01:11	10/12/2020 07:31	10/12/2020 01:11	10/12/2020 07:31	6,32	16	101,09	CHI
20201252654	ANAPOLIS	20083701	ANAPOLIS UNIVERSITARIO S2	10/12/2020 01:16	10/12/2020 09:10	10/12/2020 01:16	10/12/2020 09:10	7,90	1	7,90	CHI
20201253043	HIDROLANDIA	HD11291625	CEPAIGO S2	10/12/2020 01:18	10/12/2020 08:59	10/12/2020 01:18	10/12/2020 08:59	7,67	44	337,53	CHI
20201252657	MAIRIPOTABA	PK12263706	MORRINHOS	10/12/2020 01:33	11/12/2020 10:36	10/12/2020 01:33	11/12/2020 10:36	33,05	13	429,61	CHI
20201252658	JUSSARA	JR10426589	BRITANIA	10/12/2020 01:41	10/12/2020 13:59	10/12/2020 01:41	10/12/2020 03:12	1,51	251	379,85	CHI
20201252658	SANTA FE DE GOIAS	JR10426589	BRITANIA	10/12/2020 01:41	10/12/2020 13:59	10/12/2020 01:41	10/12/2020 03:12	1,51	9	13,62	CHI
20201252658	FAZENDA NOVA	JR10426589	BRITANIA	10/12/2020 01:41	10/12/2020 13:59	10/12/2020 01:41	10/12/2020 03:12	1,51	9	13,62	CHI
20201252658	JUSSARA	JR13403067	BRITANIA	10/12/2020 01:41	10/12/2020 13:59	10/12/2020 01:41	10/12/2020 09:12	7,52	11	82,68	CHI
20201252658	FAZENDA NOVA	JR13402995	BRITANIA	10/12/2020 01:41	10/12/2020 13:59	10/12/2020 01:41	10/12/2020 11:28	9,79	144	1409,44	CHI
20201252658	JUSSARA	JR13402995	BRITANIA	10/12/2020 01:41	10/12/2020 13:59	10/12/2020 01:41	10/12/2020 11:28	9,79	9	88,09	CHI
20201252658	JAUPACI	FN13362430	BRITANIA	10/12/2020 01:41	10/12/2020 13:59	10/12/2020 01:41	10/12/2020 13:03	11,36	2	22,73	CHI
20201252658	FAZENDA NOVA	FN13362430	BRITANIA	10/12/2020 01:41	10/12/2020 13:59	10/12/2020 01:41	10/12/2020 13:03	11,36	20	227,25	CHI
20201252658	FAZENDA NOVA	FN13362429	BRITANIA	10/12/2020 01:41	10/12/2020 13:59	10/12/2020 01:41	10/12/2020 13:59	12,30	42	516,58	CHI
20201252658	JUSSARA	FN13362429	BRITANIA	10/12/2020 01:41	10/12/2020 13:59	10/12/2020 01:41	10/12/2020 13:59	12,30	11	135,29	CHI
20201253231	SAO LUIS DE MONTES BELOS	SL12111560RE	FIRMINOPOLIS S1	10/12/2020 02:12	10/12/2020 12:48	10/12/2020 02:12	10/12/2020 08:30	6,30	12	75,59	CHI
20201253231	SAO LUIS DE MONTES BELOS	SL12111560RE	FIRMINOPOLIS S1	10/12/2020 02:12	10/12/2020 12:48	10/12/2020 02:12	10/12/2020 09:47	7,59	20	151,77	CHI
20201253231	FIRMINOPOLIS	SL12111560RE	FIRMINOPOLIS S1	10/12/2020 02:12	10/12/2020 12:48	10/12/2020 02:12	10/12/2020 09:47	7,59	6	45,53	CHI
20201253231	SAO LUIS DE MONTES BELOS	SL12111560RE	FIRMINOPOLIS S1	10/12/2020 02:12	10/12/2020 12:48	10/12/2020 02:12	10/12/2020 12:48	10,61	2	21,22	CHI
20201253231	SAO LUIS DE MONTES BELOS	SL12111560RE	FIRMINOPOLIS S1	10/12/2020 02:12	10/12/2020 12:48	10/12/2020 12:31	10/12/2020 12:48	0,28	29	8,25	CHI
20201253231	FIRMINOPOLIS	SL12111560RE	FIRMINOPOLIS S1	10/12/2020 02:12	10/12/2020 12:48	10/12/2020 12:31	10/12/2020 12:48	0,28	6	1,71	CHI
20201254451	GOIANESIA	GE12358979	GOIANESIA S2	10/12/2020 02:32	10/12/2020 11:46	10/12/2020 02:32	10/12/2020 11:46	9,22	4	36,88	CHI
20201254451	VILA PROPICIO	GE12358979	GOIANESIA S2	10/12/2020 02:32	10/12/2020 11:46	10/12/2020 02:32	10/12/2020 11:46	9,22	8	73,76	CHI
20201252675	JANDAIA	JD12391447	PALMEIRAS	10/12/2020 02:44	10/12/2020 13:31	10/12/2020 02:44	10/12/2020 13:31	10,77	8	86,19	CHI

20201253452	ITUMBIARA	IT12000215	ITUMBIARA NOVA	10/12/2020 02:47	10/12/2020 09:29	10/12/2020 02:47	10/12/2020 09:29	6,69	41	274,16	CHI
20201252854	IPAMERI	IP12266894	IPAMERI	10/12/2020 02:55	10/12/2020 09:00	10/12/2020 02:55	10/12/2020 09:00	6,08	16	97,33	CHI
20201252688	MUNDO NOVO DE GOIAS	NA10396027	NOVA CRIXAS	10/12/2020 03:16	10/12/2020 12:16	10/12/2020 03:16	10/12/2020 12:16	9,01	45	405,56	CHI
20201252688	NOVA CRIXAS	NA10396027	NOVA CRIXAS	10/12/2020 03:16	10/12/2020 12:16	10/12/2020 03:16	10/12/2020 12:16	9,01	184	1658,30	CHI
20201252689	MINACU	IH11058972	MINACU	10/12/2020 03:20	10/12/2020 03:50	10/12/2020 03:20	10/12/2020 03:50	0,49	105	50,93	CHI
20201253259	MINACU	IH12151066	MINACU	10/12/2020 03:31	10/12/2020 13:20	10/12/2020 03:31	10/12/2020 13:20	9,81	92	902,88	CHI
20201253270	CACHOEIRA ALTA	CA12196169	CACHOEIRA ALTA	10/12/2020 03:36	10/12/2020 09:28	10/12/2020 03:36	10/12/2020 09:28	5,86	5	29,28	CHI
20201252697	GUARINOS	GF12164881	SANTA TEREZINHA	10/12/2020 03:39	10/12/2020 09:30	10/12/2020 03:39	10/12/2020 09:30	5,84	36	210,29	CHI
20201253044	ITUMBIARA	IT12316685	ITUMBIARA NOVA	10/12/2020 03:40	10/12/2020 12:00	10/12/2020 03:40	10/12/2020 12:00	8,32	36	299,59	CHI
20201254838	ITUMBIARA	IT21122409	ITUMBIARA NOVA	10/12/2020 03:40	10/12/2020 17:13	10/12/2020 03:40	10/12/2020 17:13	13,54	1	13,54	CHI
20201252875	ITARUMA	IM12234538	CACHOEIRA ALTA	10/12/2020 03:43	10/12/2020 09:18	10/12/2020 03:43	10/12/2020 09:18	5,58	24	133,82	CHI
20201252875	CACU	IM12234538	CACHOEIRA ALTA	10/12/2020 03:43	10/12/2020 09:18	10/12/2020 03:43	10/12/2020 09:18	5,58	33	184,00	CHI
20201252875	JATAI	IM12234538	CACHOEIRA ALTA	10/12/2020 03:43	10/12/2020 09:18	10/12/2020 03:43	10/12/2020 09:18	5,58	20	111,52	CHI
20201252700	AMARALINA	LC21320729	MARA ROSA	10/12/2020 03:45	10/12/2020 09:43	10/12/2020 03:45	10/12/2020 09:43	5,97	1	5,97	CHI
20201252703	ALTO HORIZONTE	AJ12320992RE	SANTA TEREZINHA	10/12/2020 03:55	10/12/2020 08:17	10/12/2020 03:55	10/12/2020 08:17	4,35	47	204,55	CHI
20201252694	PORANGATU	PO12141125	NOVO PLANALTO	10/12/2020 03:57	10/12/2020 08:39	10/12/2020 03:57	10/12/2020 08:39	4,69	13	60,93	CHI
20201252707	GOIANESIA	GE12255886	GOIANESIA S1	10/12/2020 04:02	10/12/2020 08:57	10/12/2020 04:02	10/12/2020 08:57	4,92	5	24,62	CHI
20201252707	BARRO ALTO	GE12255886	GOIANESIA S1	10/12/2020 04:02	10/12/2020 08:57	10/12/2020 04:02	10/12/2020 08:57	4,92	1	4,92	CHI
20201253373	CAMPINORTE	CR12266635	MARA ROSA	10/12/2020 04:07	10/12/2020 10:40	10/12/2020 04:07	10/12/2020 10:40	6,54	3	19,62	CHI
20201253087	BONOPOLIS	BX12168258	SAO MIGUEL DO ARAGUAIA	10/12/2020 04:10	10/12/2020 16:38	10/12/2020 04:10	10/12/2020 11:46	7,60	10	75,96	CHI
20201253087	CACU	BX12168258	SAO MIGUEL DO ARAGUAIA	10/12/2020 04:10	10/12/2020 16:38	10/12/2020 04:10	10/12/2020 16:38	12,46	1	12,46	CHI
20201253087	BONOPOLIS	BX12168258	SAO MIGUEL DO ARAGUAIA	10/12/2020 04:10	10/12/2020 16:38	10/12/2020 04:10	10/12/2020 16:38	12,46	10	124,62	CHI
20201252931	JARAGUA	JA12414669	JARAGUA	10/12/2020 04:15	10/12/2020 08:21	10/12/2020 04:15	10/12/2020 08:21	4,09	226	924,97	CHI
20201252973	MINEIROS	MY12150221LD	PARQUE DAS EMAS	10/12/2020 04:22	10/12/2020 08:54	10/12/2020 04:22	10/12/2020 08:54	4,52	90	407,13	CHI
20201252973	CAIAPONIA	MY12150221LD	PARQUE DAS EMAS	10/12/2020 04:22	10/12/2020 08:54	10/12/2020 04:22	10/12/2020 08:54	4,52	5	22,62	CHI
20201252973	PEROLANDIA	MY12150221LD	PARQUE DAS EMAS	10/12/2020 04:22	10/12/2020 08:54	10/12/2020 04:22	10/12/2020 08:54	4,52	9	40,71	CHI
20201252722	ANAPOLIS	AN11351107	ANAPOLIS UNIVERSITARIO S2	10/12/2020 04:29	10/12/2020 13:22	10/12/2020 04:29	10/12/2020 13:22	8,88	38	337,41	CHI
20201252723	MONTES CLAROS DE GOIAS	ME21203471	IPORA	10/12/2020 04:30	10/12/2020 14:58	10/12/2020 04:30	10/12/2020 14:58	10,46	2	20,91	CHI
20201252725	HIDROLINA	UR12374716	URUACU	10/12/2020 04:31	10/12/2020 08:59	10/12/2020 04:31	10/12/2020 08:59	4,46	9	40,12	CHI
20201252728	CAMPINORTE	CR21168843	MARA ROSA	10/12/2020 04:33	11/12/2020 10:28	10/12/2020 04:33	11/12/2020 10:28	29,90	1	29,90	CHI
20201252760	PARANAIGUARA	PC12070705	QUIRINOPOLIS	10/12/2020 04:38	10/12/2020 09:15	10/12/2020 04:38	10/12/2020 09:15	4,60	35	161,02	CHI
20201252733	SILVANIA	SV12285478	VIANOPOLIS	10/12/2020 04:39	10/12/2020 09:02	10/12/2020 04:39	10/12/2020 09:02	4,37	77	336,87	CHI
20201253140	EDEIA	EA12026650	EDEIA	10/12/2020 04:41	10/12/2020 11:26	10/12/2020 04:41	10/12/2020 11:26	6,73	8	53,88	CHI
20201252746	ITAJA	IM12279901	CACHOEIRA ALTA	10/12/2020 04:43	10/12/2020 07:52	10/12/2020 04:43	10/12/2020 07:52	3,14	11	34,54	CHI
20201252746	ITARUMA	IM12279901	CACHOEIRA ALTA	10/12/2020 04:43	10/12/2020 07:52	10/12/2020 04:43	10/12/2020 07:52	3,14	19	59,67	CHI
20201253919	HIDROLANDIA	HD12200009	CEPAIGO S2	10/12/2020 04:48	10/12/2020 13:04	10/12/2020 04:48	10/12/2020 13:04	8,25	19	156,80	CHI
20201252748	MARA ROSA	AJ12384910RE	MARA ROSA	10/12/2020 05:05	10/12/2020 11:11	10/12/2020 05:05	10/12/2020 11:11	6,09	3	18,26	CHI
20201252748	ALTO HORIZONTE	AJ12384910RE	MARA ROSA	10/12/2020 05:05	10/12/2020 11:11	10/12/2020 05:05	10/12/2020 11:11	6,09	36	219,17	CHI
20201252749	ANICUNS	AC12000093	ANICUNS	10/12/2020 05:07	10/12/2020 07:51	10/12/2020 05:07	10/12/2020 07:51	2,73	12	32,73	CHI
20201252749	TURVANIA	AC12000093	ANICUNS	10/12/2020 05:07	10/12/2020 07:51	10/12/2020 05:07	10/12/2020 07:51	2,73	4	10,91	CHI
20201252811	FORMOSA	FA12404372	ITUIQUIRA	10/12/2020 05:08	10/12/2020 07:49	10/12/2020 05:08	10/12/2020 07:49	2,68	166	444,93	CHI
20201252786	MORRINHOS	MR12381119	MORRINHOS	10/12/2020 05:09	10/12/2020 07:54	10/12/2020 05:09	10/12/2020 07:54	2,74	23	63,08	CHI
20201252752	DAVINOPOLIS	7558123	CATALAO S1	10/12/2020 05:10	10/12/2020 08:19	10/12/2020 05:10	10/12/2020 08:19	3,14	169	530,43	CHI
20201252810	SIMOLANDIA	SA12376663	IACIARA S2	10/12/2020 05:11	10/12/2020 09:01	10/12/2020 05:11	10/12/2020 09:01	3,82	17	64,97	CHI
20201252810	POSSE	SA12376663	IACIARA S2	10/12/2020 05:11	10/12/2020 09:01	10/12/2020 05:11	10/12/2020 09:01	3,82	7	26,75	CHI
20201252933	FORMOSA	FA12366173	ITUIQUIRA	10/12/2020 05:12	10/12/2020 13:05	10/12/2020 05:12	10/12/2020 13:05	7,88	2	15,75	CHI
20201252757	MORRINHOS	MR12182966LD	MORRINHOS	10/12/2020 05:13	10/12/2020 09:59	10/12/2020 05:13	10/12/2020 09:59	4,76	14	66,66	CHI
20201253840	MINACU	IH12063608LD	MINACU	10/12/2020 05:16	11/12/2020 12:24	10/12/2020 05:16	11/12/2020 12:24	31,13	38	1182,89	CHI
20201253840	MINACU	IH12063608LD	MINACU	10/12/2020 05:16	11/12/2020 12:24	11/12/2020 09:53	11/12/2020 12:24	2,52	309	777,82	CHI
20201253064	FAINA	MS12113246	ITAPURANGA	10/12/2020 05:17	10/12/2020 09:58	10/12/2020 05:17	10/12/2020 09:58	4,67	8	37,38	CHI
20201253064	ARAGUAPAZ	MS12113246	ITAPURANGA	10/12/2020 05:17	10/12/2020 09:58	10/12/2020 05:17	10/12/2020 09:58	4,67	2	9,34	CHI

20201253064	MORRO AGUDO DE GOIAS	MS12113246	ITAPURANGA	10/12/2020 05:17	10/12/2020 09:58	10/12/2020 05:17	10/12/2020 09:58	4,67	7	32,71	CHI
20201253540	CATALAO	CT12399861	CATALAO S1	10/12/2020 05:17	10/12/2020 18:10	10/12/2020 05:17	10/12/2020 18:10	12,87	6	77,23	CHI
20201253540	GOIANDIRA	CT12399861	CATALAO S1	10/12/2020 05:17	10/12/2020 18:10	10/12/2020 05:17	10/12/2020 18:10	12,87	4	51,49	CHI
20201253210	PANAMA	PX12000436	ITUMBIAIRA NOVA	10/12/2020 05:20	10/12/2020 08:54	10/12/2020 05:20	10/12/2020 08:54	3,56	35	124,60	CHI
20201252770	BOM JARDIM DE GOIAS	BM12102073	BOM JARDIM	10/12/2020 05:23	10/12/2020 10:29	10/12/2020 05:23	10/12/2020 10:29	5,09	1	5,09	CHI
20201253698	PETROLINA DE GOIAS	PG12298071	PETROLINA	10/12/2020 05:25	10/12/2020 22:14	10/12/2020 12:30	10/12/2020 19:16	6,78	22	149,09	CHI
20201253698	PETROLINA DE GOIAS	PG12216919	PETROLINA	10/12/2020 05:25	10/12/2020 22:14	10/12/2020 05:25	10/12/2020 20:10	14,76	7	103,31	CHI
20201253698	PETROLINA DE GOIAS	PG12216919	PETROLINA	10/12/2020 05:25	10/12/2020 22:14	10/12/2020 05:25	10/12/2020 22:14	16,83	2	33,65	CHI
20201253698	SAO FRANCISCO DE GOIAS	PG12216919	PETROLINA	10/12/2020 05:25	10/12/2020 22:14	10/12/2020 05:25	10/12/2020 22:14	16,83	1	16,83	CHI
20201253698	PETROLINA DE GOIAS	PG12216919	PETROLINA	10/12/2020 05:25	10/12/2020 22:14	10/12/2020 21:42	10/12/2020 22:14	0,53	7	3,73	CHI
20201252775	ANAPOLIS	AN11072951	JUNDIAI S1	10/12/2020 05:26	10/12/2020 09:40	10/12/2020 05:26	10/12/2020 09:40	4,24	211	893,70	CHI
20201252225	ITAUCU	IX12049364	INHUMAS S2	10/12/2020 05:27	10/12/2020 11:33	10/12/2020 05:27	10/12/2020 11:33	6,10	13	79,29	CHI
20201252225	SANTA ROSA DE GOIAS	IX12049364	INHUMAS S2	10/12/2020 05:27	10/12/2020 11:33	10/12/2020 05:27	10/12/2020 11:33	6,10	11	67,09	CHI
20201252795	ITAPIRAPUA	IU12037339	JUSSARA	10/12/2020 05:29	10/12/2020 19:42	10/12/2020 05:29	10/12/2020 19:42	14,22	7	99,56	CHI
20201252795	NOVO BRASIL	IU12037339	JUSSARA	10/12/2020 05:29	10/12/2020 19:42	10/12/2020 05:29	10/12/2020 19:42	14,22	1	14,22	CHI
20201254154	MINEIROS	MY12360820	PARQUE DAS EMAS	10/12/2020 05:29	10/12/2020 11:03	10/12/2020 05:29	10/12/2020 11:03	5,56	9	50,04	CHI
20201254781	MINEIROS	MY12390605RE	PARQUE DAS EMAS	10/12/2020 05:32	13/12/2020 16:57	10/12/2020 05:32	12/12/2020 09:50	52,30	9	470,72	CHI
20201254781	MINEIROS	MY12241802RE	PARQUE DAS EMAS	10/12/2020 05:32	13/12/2020 16:57	12/12/2020 12:55	12/12/2020 15:30	2,58	9	23,23	CHI
20201254781	MINEIROS	MY12390605RE	PARQUE DAS EMAS	10/12/2020 05:32	13/12/2020 16:57	12/12/2020 13:16	12/12/2020 16:00	2,73	9	24,60	CHI
20201254781	MINEIROS	MY12241802RE	PARQUE DAS EMAS	10/12/2020 05:32	13/12/2020 16:57	12/12/2020 19:39	13/12/2020 00:25	4,76	9	42,88	CHI
20201254781	MINEIROS	MY12390605RE	PARQUE DAS EMAS	10/12/2020 05:32	13/12/2020 16:57	13/12/2020 13:03	13/12/2020 15:41	2,65	9	23,83	CHI
20201254781	MINEIROS	MY12390605RE	PARQUE DAS EMAS	10/12/2020 05:32	13/12/2020 16:57	10/12/2020 05:32	13/12/2020 16:40	83,14	6	498,81	CHI
20201254781	MINEIROS	MY12390605RE	PARQUE DAS EMAS	10/12/2020 05:32	13/12/2020 16:57	10/12/2020 05:32	13/12/2020 16:57	83,42	1	83,42	CHI
20201252831	FORMOSA	FA12207282	ITUIQUIRA	10/12/2020 05:33	10/12/2020 10:59	10/12/2020 05:33	10/12/2020 10:59	5,43	14	76,04	CHI
20201252791	GOIANESIA	S50058163	GOIANESIA S2	10/12/2020 05:34	10/12/2020 10:00	10/12/2020 05:34	10/12/2020 10:00	4,43	1	4,43	CHI
20201252793	HEITORAI	HE11227155	ITABERAI S1	10/12/2020 05:34	10/12/2020 16:25	10/12/2020 05:34	10/12/2020 16:25	10,84	1	10,84	CHI
20201252840	GOIATUBA	BJ12030804	RIO DOS BOIS	10/12/2020 05:35	12/12/2020 00:28	10/12/2020 05:35	12/12/2020 00:28	42,88	1	42,88	CHI
20201252840	BOM JESUS DE GOIAS	BJ12030804	RIO DOS BOIS	10/12/2020 05:35	12/12/2020 00:28	10/12/2020 05:35	12/12/2020 00:28	42,88	4	171,53	CHI
20201252980	MINEIROS	PW12374393	PARQUE DAS EMAS	10/12/2020 05:36	10/12/2020 10:51	10/12/2020 05:36	10/12/2020 10:51	5,24	5	26,20	CHI
20201252824	MOSSAMEDES	MD12299605	ITABERAI S2	10/12/2020 05:37	10/12/2020 08:00	10/12/2020 05:37	10/12/2020 08:00	2,37	5	11,87	CHI
20201252919	ITAPURANGA	IK12250609	ITAPURANGA	10/12/2020 05:37	10/12/2020 07:30	10/12/2020 05:37	10/12/2020 07:30	1,87	22	41,23	CHI
20201253136	RUBIATABA	RB12126565	RUBIATABA	10/12/2020 05:37	10/12/2020 11:38	10/12/2020 05:37	10/12/2020 11:38	6,01	54	324,30	CHI
20201252801	SANTA TEREZINHA DE GOIAS	SG12202092	SANTA TEREZINHA	10/12/2020 05:39	10/12/2020 11:08	10/12/2020 05:39	10/12/2020 11:08	5,48	6	32,87	CHI
20201252802	PORTEIRAO	CL21295999	RIO DOS BOIS	10/12/2020 05:39	10/12/2020 15:44	10/12/2020 05:39	10/12/2020 15:44	10,08	1	10,08	CHI
20201252804	ALTO HORIZONTE	AJ21100995	SANTA TEREZINHA	10/12/2020 05:40	10/12/2020 09:26	10/12/2020 05:40	10/12/2020 09:26	3,76	1	3,76	CHI
20201254871	MINEIROS	MY12324344	PARQUE DAS EMAS	10/12/2020 05:40	10/12/2020 11:39	10/12/2020 05:40	10/12/2020 11:39	5,97	7	41,80	CHI
20201253164	LUZIANIA	LZ12033418	RIO VERMELHO	10/12/2020 05:41	10/12/2020 08:19	10/12/2020 05:41	10/12/2020 08:19	2,63	20	52,54	CHI
20201252809	URUACU	UR12003395	URUACU	10/12/2020 05:42	10/12/2020 10:18	10/12/2020 05:42	10/12/2020 10:18	4,59	8	36,72	CHI
20201252986	TURVANIA	TV12111577	FIRMINOPOLIS S1	10/12/2020 05:43	10/12/2020 08:40	10/12/2020 05:43	10/12/2020 08:40	2,94	8	23,56	CHI
20201252986	FIRMINOPOLIS	TV12111577	FIRMINOPOLIS S1	10/12/2020 05:43	10/12/2020 08:40	10/12/2020 05:43	10/12/2020 08:40	2,94	2	5,89	CHI
20201253841	CAIAPONIA	CP12342210	CAIAPONIA	10/12/2020 05:44	10/12/2020 09:07	10/12/2020 05:44	10/12/2020 09:07	3,37	42	141,53	CHI
20201252814	BOM JARDIM DE GOIAS	BM12190379	BOM JARDIM	10/12/2020 05:45	10/12/2020 08:44	10/12/2020 05:45	10/12/2020 08:44	2,98	3	8,93	CHI
20201252817	CEZARINA	CZ12116977	CEZARINA	10/12/2020 05:46	10/12/2020 07:29	10/12/2020 05:46	10/12/2020 07:29	1,72	10	17,15	CHI
20201252819	GOIATUBA	GT12378951	GOIATUBA S1	10/12/2020 05:46	10/12/2020 18:03	10/12/2020 05:46	10/12/2020 18:03	12,27	6	73,64	CHI
20201252819	RUBIATABA	GT12378951	GOIATUBA S1	10/12/2020 05:46	10/12/2020 18:03	10/12/2020 05:46	10/12/2020 18:03	12,27	1	12,27	CHI
20201253179	CACU	CC12194911	CACHOEIRA ALTA	10/12/2020 05:46	10/12/2020 11:57	10/12/2020 05:46	10/12/2020 11:57	6,18	132	815,58	CHI
20201253916	ITAPIRAPUA	IU12259711	MATRINCHA	10/12/2020 05:46	10/12/2020 15:20	10/12/2020 05:46	10/12/2020 15:20	9,57	5	47,83	CHI
20201252822	CATURAI	CK12095043	ARACU	10/12/2020 05:47	10/12/2020 11:20	10/12/2020 05:47	10/12/2020 11:20	5,54	3	16,61	CHI
20201255407	JATAI	JT12062162	JATAI S1	10/12/2020 05:47	10/12/2020 20:40	10/12/2020 05:47	10/12/2020 20:40	14,87	36	535,49	CHI
20201253885	EDEIA	EA12160409	VICENTINOPOLIS	10/12/2020 05:49	10/12/2020 12:13	10/12/2020 05:49	10/12/2020 12:13	6,39	21	134,15	CHI
20201252905	PONTALINA	PK12074320	VICENTINOPOLIS	10/12/2020 05:51	11/12/2020 08:21	10/12/2020 05:51	11/12/2020 08:21	26,50	19	503,45	CHI

20201253312	DOVERLANDIA	DV12207962	CAIAPONIA	10/12/2020 05:51	10/12/2020 11:15	10/12/2020 05:51	10/12/2020 11:15	5,38	7	37,69	CHI
20201253938	JATAI	JT12303380RE	JATAI S1	10/12/2020 05:51	10/12/2020 11:27	10/12/2020 05:51	10/12/2020 11:27	5,59	26	145,24	CHI
20201252966	PIRACANJUBA	PJ12097886	BELA VISTA S1	10/12/2020 05:52	10/12/2020 10:32	10/12/2020 05:52	10/12/2020 10:32	4,66	6	27,97	CHI
20201247337	FLORES DE GOIAS	FB12085509	FLORES DE GOIAS	10/12/2020 05:54	10/12/2020 13:42	10/12/2020 05:54	10/12/2020 13:42	7,78	9	70,06	CHI
20201252844	GOIANDIRA	GD11000004	CATALAO S1	10/12/2020 05:55	10/12/2020 09:30	10/12/2020 05:55	10/12/2020 09:30	3,58	124	443,89	CHI
20201252944	PALMEIRAS DE GOIAS	PL12289855	ANICUNS	10/12/2020 05:55	10/12/2020 07:25	10/12/2020 05:55	10/12/2020 07:25	1,49	23	34,16	CHI
20201253439	LUZIANIA	LZ12383059	CRISTALINA S2	10/12/2020 05:55	10/12/2020 10:35	10/12/2020 05:55	10/12/2020 10:35	4,66	85	396,50	CHI
20201253074	AGUA FRIA DE GOIAS	MJ12320111	PADRE BERNARDO	10/12/2020 05:56	10/12/2020 08:07	10/12/2020 05:56	10/12/2020 08:07	2,17	9	19,57	CHI
20201252851	RIO VERDE	RV12273698	CABRIUVA S2	10/12/2020 05:57	10/12/2020 12:48	10/12/2020 05:57	10/12/2020 12:48	6,84	1	6,84	CHI
20201252852	JATAI	JT1105128	JATAI S2	10/12/2020 05:57	10/12/2020 13:05	10/12/2020 05:57	10/12/2020 13:05	7,12	1	7,12	CHI
20201253059	MARA ROSA	MQ12135696	MARA ROSA	10/12/2020 05:58	10/12/2020 09:18	10/12/2020 05:58	10/12/2020 09:18	3,33	9	29,99	CHI
20201254182	SANTA CRUZ DE GOIAS	BC12390409	PIRES DO RIO S2	10/12/2020 05:58	10/12/2020 20:21	10/12/2020 05:58	10/12/2020 20:21	14,37	8	114,98	CHI
20201252907	JESUPOLIS	SF12066036	SAO FRANCISCO DE GOIAS	10/12/2020 06:00	10/12/2020 10:23	10/12/2020 06:00	10/12/2020 10:23	4,38	16	70,07	CHI
20201252867	JATAI	JT121202647	JATAI S1	10/12/2020 06:01	10/12/2020 18:27	10/12/2020 06:01	10/12/2020 18:27	12,42	1	12,42	CHI
20201252957	JAUPACI	JP12074459	IPORA	10/12/2020 06:01	10/12/2020 08:36	10/12/2020 06:01	10/12/2020 08:36	2,58	5	12,90	CHI
20201252957	DIORAMA	JP12074459	IPORA	10/12/2020 06:01	10/12/2020 08:36	10/12/2020 06:01	10/12/2020 08:36	2,58	3	7,74	CHI
20201253696	PEROLANDIA	DP12260367	JATAI S1	10/12/2020 06:02	10/12/2020 09:14	10/12/2020 06:02	10/12/2020 09:14	3,19	6	19,14	CHI
20201252874	ITABERAI	IB11359514	ITABERAI S1	10/12/2020 06:03	10/12/2020 10:08	10/12/2020 06:03	10/12/2020 10:08	4,08	2	8,16	CHI
20201253034	AURILANDIA	AI12000010	FIRMINOPOLIS S2	10/12/2020 06:03	10/12/2020 07:40	10/12/2020 06:03	10/12/2020 07:40	1,61	2	3,22	CHI
20201253034	FIRMINOPOLIS	AI12000010	FIRMINOPOLIS S2	10/12/2020 06:03	10/12/2020 07:40	10/12/2020 06:03	10/12/2020 07:40	1,61	6	9,67	CHI
20201253110	JUSSARA	JR12124817	BRITANIA	10/12/2020 06:03	10/12/2020 12:21	10/12/2020 06:03	10/12/2020 12:21	6,30	11	69,30	CHI
20201252879	ALVORADA DO NORTE	AQ21125264	IACIARA S2	10/12/2020 06:04	10/12/2020 16:39	10/12/2020 06:04	10/12/2020 16:39	10,57	1	10,57	CHI
20201252880	ARAGARCAS	1820043992	ARAGARCAS	10/12/2020 06:04	10/12/2020 08:56	10/12/2020 06:04	10/12/2020 08:56	2,85	1	2,85	CHI
20201253245	JANDAIA	JD11198353	PALMEIRAS	10/12/2020 06:04	10/12/2020 09:13	10/12/2020 06:04	10/12/2020 09:13	3,15	227	714,86	CHI
20201254225	MINACU	IH12063612	MINACU	10/12/2020 06:04	10/12/2020 14:06	10/12/2020 06:04	10/12/2020 14:06	8,02	413	3311,46	CHI
20201252882	FLORES DE GOIAS	FA12038556	SAO JOAO D ALIANCA	10/12/2020 06:05	10/12/2020 10:48	10/12/2020 06:05	10/12/2020 10:48	4,71	7	32,98	CHI
20201252882	FORMOSA	FA12038556	SAO JOAO D ALIANCA	10/12/2020 06:05	10/12/2020 10:48	10/12/2020 06:05	10/12/2020 10:48	4,71	101	475,79	CHI
20201253166	SERRANOPOLIS	SX12241669	JATAI S1	10/12/2020 06:05	10/12/2020 14:58	10/12/2020 06:05	10/12/2020 14:58	8,87	13	115,32	CHI
20201252885	JARAGUA	70087623	JARAGUA	10/12/2020 06:06	10/12/2020 14:04	10/12/2020 06:06	10/12/2020 14:04	7,96	1	7,96	CHI
20201252887	PIRES DO RIO	OZ12000351RE	PIRES DO RIO S1	10/12/2020 06:06	10/12/2020 08:23	10/12/2020 06:06	10/12/2020 08:23	2,27	4	9,08	CHI
20201252887	ORIZONA	OZ12000351RE	PIRES DO RIO S1	10/12/2020 06:06	10/12/2020 08:23	10/12/2020 06:06	10/12/2020 08:23	2,27	57	129,44	CHI
20201252888	PIRES DO RIO	PR21154622	PIRES DO RIO S1	10/12/2020 06:06	10/12/2020 08:13	10/12/2020 06:06	10/12/2020 08:13	2,10	1	2,10	CHI
20201252891	NIQUELANDIA	NQ12416338	NIQUELANDIA SUBTRANSMISSAO	10/12/2020 06:07	10/12/2020 08:53	10/12/2020 06:07	10/12/2020 08:53	2,77	103	284,82	CHI
20201252950	JATAI	JT18000231TS	JATAI S1	10/12/2020 06:07	10/12/2020 07:56	10/12/2020 06:07	10/12/2020 07:56	1,80	66	118,84	CHI
20201252981	CRIXAS	CX12145539	RUBIATABA	10/12/2020 06:07	11/12/2020 13:14	10/12/2020 06:07	11/12/2020 13:14	31,12	19	591,21	CHI
20201252899	PONTALINA	PK12340362RE	PONTALINA	10/12/2020 06:08	10/12/2020 13:51	10/12/2020 06:08	10/12/2020 13:51	7,71	65	501,13	CHI
20201252900	CAIAPONIA	CP21134311	CAIAPONIA	10/12/2020 06:08	10/12/2020 12:08	10/12/2020 06:08	10/12/2020 12:08	5,99	1	5,99	CHI
20201252916	FAINA	FC12321457	GOIAS	10/12/2020 06:08	10/12/2020 11:56	10/12/2020 06:08	10/12/2020 11:56	5,79	22	127,42	CHI
20201252992	GOIANIA	GN12383183	XAVANTES	10/12/2020 06:08	10/12/2020 08:39	10/12/2020 06:08	10/12/2020 08:39	2,51	238	597,78	CHI
20201254899	JATAI	JT12264399	JATAI S1	10/12/2020 06:08	10/12/2020 13:20	10/12/2020 06:08	10/12/2020 13:20	7,19	5	35,93	CHI
20201252439	ITARUMA	SX12264389RE	JATAI S1	10/12/2020 06:09	10/12/2020 08:16	10/12/2020 06:09	10/12/2020 08:16	2,11	1	2,11	CHI
20201252439	APORE	SX12264389RE	JATAI S1	10/12/2020 06:09	10/12/2020 08:16	10/12/2020 06:09	10/12/2020 08:16	2,11	7	14,78	CHI
20201252439	SERRANOPOLIS	SX12264389RE	JATAI S1	10/12/2020 06:09	10/12/2020 08:16	10/12/2020 06:09	10/12/2020 08:16	2,11	53	111,89	CHI
20201253583	GOIAS	GS12058298	MATRINCHA	10/12/2020 06:10	10/12/2020 09:32	10/12/2020 06:10	10/12/2020 09:32	3,36	27	90,70	CHI
20201254977	ITUMBIARA	IT12075764	ITUMBIARA VELHA S2	10/12/2020 06:10	11/12/2020 09:55	10/12/2020 06:10	11/12/2020 09:55	27,74	7	194,16	CHI
20201252925	MARA ROSA	LC12308828	MARA ROSA	10/12/2020 06:12	10/12/2020 12:06	10/12/2020 06:12	10/12/2020 12:06	5,89	1	5,89	CHI
20201252925	AMARALINA	LC12308828	MARA ROSA	10/12/2020 06:12	10/12/2020 12:06	10/12/2020 06:12	10/12/2020 12:06	5,89	2	11,78	CHI
20201255862	JARAGUA	JA12047472	JARAGUA	10/12/2020 06:12	10/12/2020 16:19	10/12/2020 06:12	10/12/2020 16:19	10,11	10	101,15	CHI
20201252928	QUIRINOPOLIS	QI21249074	QUIRINOPOLIS	10/12/2020 06:13	10/12/2020 12:34	10/12/2020 06:13	10/12/2020 12:34	6,35	1	6,35	CHI
20201253375	MINACU	IH12129795	MINACU	10/12/2020 06:13	11/12/2020 01:54	10/12/2020 06:13	11/12/2020 01:54	19,67	36	708,07	CHI
20201254325	GOIAS	GS12085888	GOIAS	10/12/2020 06:13	10/12/2020 12:43	10/12/2020 06:13	10/12/2020 12:43	6,50	23	149,41	CHI

20201252938	RIO VERDE	RV21326870	CABRIUVA S2	10/12/2020 06:14	10/12/2020 11:42	10/12/2020 06:14	10/12/2020 11:42	5,46	1	5,46	CHI
20201253029	ARENOPOLIS	AY12235874	IPORA	10/12/2020 06:14	10/12/2020 09:54	10/12/2020 06:14	10/12/2020 09:54	3,65	7	25,55	CHI
20201253029	PIRANHAS	AY12235874	IPORA	10/12/2020 06:14	10/12/2020 09:54	10/12/2020 06:14	10/12/2020 09:54	3,65	1	3,65	CHI
20201253242	CAMPOS VERDES	SG12202098RE	SANTA TEREZINHA	10/12/2020 06:14	10/12/2020 11:38	10/12/2020 06:14	10/12/2020 11:38	5,40	40	215,93	CHI
20201253242	UIRAPURU	SG12202098RE	SANTA TEREZINHA	10/12/2020 06:14	10/12/2020 11:38	10/12/2020 06:14	10/12/2020 11:38	5,40	59	318,50	CHI
20201253242	SANTA TEREZINHA DE GOIAS	SG12202098RE	SANTA TEREZINHA	10/12/2020 06:14	10/12/2020 11:38	10/12/2020 06:14	10/12/2020 11:38	5,40	138	744,97	CHI
20201253266	SAO MIGUEL DO ARAGUAIA	SM12192361	SAO MIGUEL DO ARAGUAIA	10/12/2020 06:15	10/12/2020 08:53	10/12/2020 06:15	10/12/2020 08:53	2,62	168	440,81	CHI
20201255923	SERRANOPOLIS	SX12324832	JATAI S1	10/12/2020 06:15	10/12/2020 16:11	10/12/2020 06:15	10/12/2020 16:11	9,93	13	129,11	CHI
20201252951	CRISTALINA	KR21328927	CRISTALINA S1	10/12/2020 06:16	10/12/2020 08:02	10/12/2020 06:16	10/12/2020 08:02	1,76	1	1,76	CHI
20201253244	PIRENOPOLIS	JA12000001LD	JARAGUA	10/12/2020 06:16	10/12/2020 22:16	10/12/2020 06:16	10/12/2020 22:16	15,99	55	879,56	CHI
20201253244	JARAGUA	JA12000001LD	JARAGUA	10/12/2020 06:16	10/12/2020 22:16	10/12/2020 06:16	10/12/2020 22:16	15,99	382	6108,92	CHI
20201253314	MONTES CLAROS DE GOIAS	ME12334772	ARENOPOLIS	10/12/2020 06:16	11/12/2020 10:05	10/12/2020 06:16	11/12/2020 10:05	27,81	11	305,87	CHI
20201253397	CACU	CC12242152	CACHOEIRA ALTA	10/12/2020 06:16	10/12/2020 17:19	10/12/2020 14:18	10/12/2020 16:00	1,70	119	202,04	CHI
20201253397	CACU	CC11242153	CACHOEIRA ALTA	10/12/2020 06:16	10/12/2020 17:19	10/12/2020 06:16	10/12/2020 17:19	11,05	132	1458,60	CHI
20201252997	PADRE BERNARDO	PB12317821	PADRE BERNARDO	10/12/2020 06:17	10/12/2020 09:42	10/12/2020 06:17	10/12/2020 09:42	3,41	86	293,36	CHI
20201252968	SANTO ANTONIO DO DESCOBERTO	SN21086752	ALEXANIA	10/12/2020 06:19	10/12/2020 07:35	10/12/2020 06:19	10/12/2020 07:35	1,25	1	1,25	CHI
20201253586	MINACU	IH11056161	MINACU	10/12/2020 06:20	10/12/2020 10:56	10/12/2020 06:20	10/12/2020 10:56	4,59	120	551,00	CHI
20201253622	LGOA SANTA	IJ12017218	ITAJA S2	10/12/2020 06:20	10/12/2020 10:34	10/12/2020 06:20	10/12/2020 10:34	4,22	4	16,87	CHI
20201253622	ITAJA	IJ12017218	ITAJA S2	10/12/2020 06:20	10/12/2020 10:34	10/12/2020 06:20	10/12/2020 10:34	4,22	24	101,21	CHI
20201252978	CRIXAS	NA12126913	NOVA CRIXAS	10/12/2020 06:22	10/12/2020 07:54	10/12/2020 06:22	10/12/2020 07:54	1,53	2	3,06	CHI
20201252978	NOVA CRIXAS	NA12126913	NOVA CRIXAS	10/12/2020 06:22	10/12/2020 07:54	10/12/2020 06:22	10/12/2020 07:54	1,53	1	1,53	CHI
20201253814	CORUMBAIBA	CI12064619	VILA CORUMBA	10/12/2020 06:23	10/12/2020 12:46	10/12/2020 06:23	10/12/2020 12:46	6,38	38	242,36	CHI
20201253845	CORUMBAIBA	CI11054936	VILA CORUMBA	10/12/2020 06:23	10/12/2020 10:31	10/12/2020 06:23	10/12/2020 10:31	4,12	164	675,41	CHI
20201254341	PILAR DE GOIAS	AJ12375644	SANTA TEREZINHA	10/12/2020 06:23	10/12/2020 10:14	10/12/2020 06:23	10/12/2020 10:14	3,85	1	3,85	CHI
20201254341	ALTO HORIZONTE	AJ12375644	SANTA TEREZINHA	10/12/2020 06:23	10/12/2020 10:14	10/12/2020 06:23	10/12/2020 10:14	3,85	9	34,62	CHI
20201253372	BOM JESUS DE GOIAS	DM12153969	RIO DOS BOIS	10/12/2020 06:24	10/12/2020 21:09	10/12/2020 06:24	10/12/2020 21:09	14,74	1	14,74	CHI
20201253372	QUIRINOPOLIS	DM12153969	RIO DOS BOIS	10/12/2020 06:24	10/12/2020 21:09	10/12/2020 06:24	10/12/2020 21:09	14,74	9	132,68	CHI
20201253372	CASTELANDIA	DM12153969	RIO DOS BOIS	10/12/2020 06:24	10/12/2020 21:09	10/12/2020 06:24	10/12/2020 21:09	14,74	6	88,46	CHI
20201254748	ITAPIRAPUA	IU12030155	JUSSARA	10/12/2020 06:24	10/12/2020 14:18	10/12/2020 06:24	10/12/2020 14:18	7,89	35	276,18	CHI
20201252996	HIDROLANDIA	HD11313034	CEPAIGO S2	10/12/2020 06:25	10/12/2020 10:52	10/12/2020 06:25	10/12/2020 10:52	4,44	4	17,78	CHI
20201253002	PALMELO	PZ11216192	PIRES DO RIO S2	10/12/2020 06:25	10/12/2020 09:34	10/12/2020 06:25	10/12/2020 09:34	3,14	40	125,50	CHI
20201253624	MOZARLANDIA	MZ12055640	MOZARLANDIA	10/12/2020 06:25	10/12/2020 11:23	10/12/2020 06:25	10/12/2020 11:23	4,96	9	44,61	CHI
20201253942	FAINA	FC12147790	GOIAS	10/12/2020 06:25	10/12/2020 15:01	10/12/2020 06:25	10/12/2020 15:01	8,59	6	51,52	CHI
20201253006	AMARALINA	LC12252699	MARA ROSA	10/12/2020 06:26	10/12/2020 09:29	10/12/2020 06:26	10/12/2020 09:29	3,05	8	24,39	CHI
20201253007	GOIANIA	10001718841	MEIA PONTE	10/12/2020 06:26	10/12/2020 08:15	10/12/2020 06:26	10/12/2020 08:15	1,81	1	1,81	CHI
20201253733	MINEIROS	MY12348221	PARQUE DAS EMAS	10/12/2020 06:26	10/12/2020 12:42	10/12/2020 06:26	10/12/2020 12:42	6,25	9	56,27	CHI
20201253010	RIO VERDE	RV11029066	SANTA HELENA S1	10/12/2020 06:27	10/12/2020 10:44	10/12/2020 06:27	10/12/2020 10:44	4,28	75	321,29	CHI
20201253011	FAINA	FC21196420	GOIAS	10/12/2020 06:27	10/12/2020 12:58	10/12/2020 06:27	10/12/2020 12:58	6,51	1	6,51	CHI
20201253014	SAO MIGUEL DO ARAGUAIA	SM21280149	SAO MIGUEL DO ARAGUAIA	10/12/2020 06:27	10/12/2020 08:26	10/12/2020 06:27	10/12/2020 08:26	1,97	1	1,97	CHI
20201253567	GOIAS	GS12071260	GOIAS	10/12/2020 06:27	10/12/2020 09:06	10/12/2020 06:27	10/12/2020 09:06	2,64	9	23,78	CHI
20201253377	HIDROLANDIA	HD11000126	CEPAIGO S2	10/12/2020 06:28	10/12/2020 09:55	10/12/2020 06:28	10/12/2020 09:55	3,45	171	589,19	CHI
20201253023	MARA ROSA	MQ12208443	NOVA CRIXAS	10/12/2020 06:29	10/12/2020 21:05	10/12/2020 06:29	10/12/2020 21:05	14,60	1	14,60	CHI
20201253023	AMARALINA	MQ12208443	NOVA CRIXAS	10/12/2020 06:29	10/12/2020 21:05	10/12/2020 06:29	10/12/2020 21:05	14,60	1	14,60	CHI
20201253025	FORMOSA	FA12392207	ITUIQUIRA	10/12/2020 06:29	10/12/2020 12:47	10/12/2020 06:29	10/12/2020 12:47	6,29	2	12,58	CHI
20201253028	NIQUELANDIA	2750063870	NIQUELANDIA SUBTRANSMISSAO	10/12/2020 06:29	10/12/2020 11:00	10/12/2020 06:29	10/12/2020 11:00	4,50	1	4,50	CHI
20201253190	SENADOR CANEDO	SW12092633LD	SENADOR CANEDO	10/12/2020 06:29	10/12/2020 08:29	10/12/2020 06:29	10/12/2020 08:29	1,99	20	39,77	CHI
20201253669	AURILANDIA	AI12289759	FIRMINOPOLIS S2	10/12/2020 06:29	10/12/2020 10:34	10/12/2020 06:29	10/12/2020 10:34	4,07	4	16,29	CHI
20201253669	FIRMINOPOLIS	AI12289759	FIRMINOPOLIS S2	10/12/2020 06:29	10/12/2020 10:34	10/12/2020 06:29	10/12/2020 10:34	4,07	1	4,07	CHI
20201253694	CACU	CC11102485	CACHOEIRA ALTA	10/12/2020 06:30	10/12/2020 10:57	10/12/2020 06:30	10/12/2020 10:57	4,44	111	492,72	CHI
20201253036	PIRACANJUBA	60088710	PIRACANJUBA	10/12/2020 06:31	10/12/2020 17:06	10/12/2020 06:31	10/12/2020 17:06	10,58	1	10,58	CHI
20201253796	CRISTALINA	KR11032628	PAMPLONA	10/12/2020 06:31	10/12/2020 13:01	10/12/2020 06:31	10/12/2020 13:01	6,50	81	526,21	CHI

20201253127	MINACU	IH11052600	MINACU	10/12/2020 06:34	11/12/2020 00:10	10/12/2020 06:34	11/12/2020 00:10	17,59	77	1354,22	CHI
20201253055	MINEIROS	MY12324396RE	PARQUE DAS EMAS	10/12/2020 06:35	10/12/2020 10:50	10/12/2020 06:35	10/12/2020 10:50	4,24	18	76,34	CHI
20201253056	SANTA ROSA DE GOIAS	SR12000047	INHUMAS S1	10/12/2020 06:35	10/12/2020 16:03	10/12/2020 06:35	10/12/2020 16:03	9,45	54	510,52	CHI
20201253058	VILA BOA	VB12394155	ITUIQUIRA	10/12/2020 06:36	10/12/2020 14:12	10/12/2020 06:36	10/12/2020 14:12	7,60	22	167,09	CHI
20201254296	PIRENOPOLIS	PV12392221	CORUMBA	10/12/2020 06:36	10/12/2020 12:30	10/12/2020 06:36	10/12/2020 12:30	5,90	36	212,23	CHI
20201253070	CAMPOS BELOS	CH12320563	SAO DOMINGOS	10/12/2020 06:38	10/12/2020 09:40	10/12/2020 06:38	10/12/2020 09:40	3,03	8	24,25	CHI
20201254793	CATALAO	CT12093871	CATALAO S1	10/12/2020 06:38	10/12/2020 15:12	10/12/2020 06:38	10/12/2020 15:12	8,56	40	342,32	CHI
20201253080	VIANOPOLIS	VN21159853	VIANOPOLIS	10/12/2020 06:40	10/12/2020 11:32	10/12/2020 06:40	10/12/2020 11:32	4,85	1	4,85	CHI
20201253081	GOIANIA	GN11001626	CAMPINAS S1	10/12/2020 06:41	10/12/2020 08:15	10/12/2020 06:41	10/12/2020 08:15	1,56	87	136,01	CHI
20201253083	GOIANIA	GN11043360	XAVANTES	10/12/2020 06:41	10/12/2020 08:38	10/12/2020 07:41	10/12/2020 08:38	0,94	88	82,99	CHI
20201253234	GOIATUBA	BJ12392121	BOM JESUS DE GOIAS	10/12/2020 06:41	10/12/2020 13:39	10/12/2020 06:41	10/12/2020 13:39	6,96	16	111,35	CHI
20201253468	GOIATUBA	BG12000121	GOIATUBA S2	10/12/2020 06:41	10/12/2020 12:02	10/12/2020 06:41	10/12/2020 12:02	5,34	1	5,34	CHI
20201253468	BURITI ALEGRE	BG12000121	GOIATUBA S2	10/12/2020 06:41	10/12/2020 12:02	10/12/2020 06:41	10/12/2020 12:02	5,34	15	80,04	CHI
20201254285	PORANGATU	TA12114216	NOVO PLANALTO	10/12/2020 06:41	10/12/2020 14:33	10/12/2020 06:41	10/12/2020 14:33	7,86	6	47,15	CHI
20201253093	SANTA RITA DO NOVO DESTINO	BA12208877	BARRO ALTO	10/12/2020 06:42	10/12/2020 14:17	10/12/2020 06:42	10/12/2020 14:17	7,58	29	219,71	CHI
20201253424	LEOPOLDO DE BULHOES	LB12000008	DAIA S2	10/12/2020 06:42	10/12/2020 08:53	10/12/2020 06:42	10/12/2020 08:53	2,17	161	349,33	CHI
20201253424	SILVANIA	LB12000008	DAIA S2	10/12/2020 06:42	10/12/2020 08:53	10/12/2020 06:42	10/12/2020 08:53	2,17	98	212,63	CHI
20201253424	GAMELEIRA DE GOIAS	LB12000008	DAIA S2	10/12/2020 06:42	10/12/2020 08:53	10/12/2020 06:42	10/12/2020 08:53	2,17	16	34,72	CHI
20201254000	CATURAI	CK12018943	INHUMAS S1	10/12/2020 06:42	10/12/2020 12:27	10/12/2020 06:42	10/12/2020 12:27	5,74	2	11,49	CHI
20201254956	JESUPOLIS	JA12297982	SAO FRANCISCO DE GOIAS	10/12/2020 06:42	10/12/2020 13:04	10/12/2020 06:42	10/12/2020 13:04	6,37	5	31,83	CHI
20201254956	JARAGUA	JA12297982	SAO FRANCISCO DE GOIAS	10/12/2020 06:42	10/12/2020 13:04	10/12/2020 06:42	10/12/2020 13:04	6,37	25	159,16	CHI
20201253097	PARAUNA	PU21259245	PARAUNA	10/12/2020 06:43	10/12/2020 09:14	10/12/2020 06:43	10/12/2020 09:14	2,53	1	2,53	CHI
20201253101	FIRMINOPOLIS	FR21118706	FIRMINOPOLIS S1	10/12/2020 06:43	10/12/2020 09:46	10/12/2020 06:43	10/12/2020 09:46	3,04	1	3,04	CHI
20201253107	ITAJA	2300007533	ITAJA S2	10/12/2020 06:44	10/12/2020 09:13	10/12/2020 06:44	10/12/2020 09:13	2,47	1	2,47	CHI
20201253527	PORANGATU	PO12391647	NOVO PLANALTO	10/12/2020 06:44	10/12/2020 09:30	10/12/2020 06:44	10/12/2020 09:30	2,77	26	72,07	CHI
20201253109	ITUMBIARA	IT21408202	PARANAIBA	10/12/2020 06:45	10/12/2020 10:37	10/12/2020 06:45	10/12/2020 10:37	3,86	1	3,86	CHI
20201253200	GOIATUBA	BJ12256996	BOM JESUS DE GOIAS	10/12/2020 06:45	10/12/2020 19:43	10/12/2020 06:45	10/12/2020 19:43	12,95	48	621,80	CHI
20201253200	BOM JESUS DE GOIAS	BJ12256996	BOM JESUS DE GOIAS	10/12/2020 06:45	10/12/2020 19:43	10/12/2020 06:45	10/12/2020 19:43	12,95	15	194,31	CHI
20201253202	PALMEIRAS DE GOIAS	PL12028968	PALMEIRAS	10/12/2020 06:45	10/12/2020 08:31	10/12/2020 06:45	10/12/2020 08:31	1,75	4	7,00	CHI
20201253116	ITAPIRAPUA	IU12250533	MATRINCHA	10/12/2020 06:46	10/12/2020 16:54	10/12/2020 06:46	10/12/2020 16:54	10,13	1	10,13	CHI
20201253923	FAZENDA NOVA	NB12378824	JUSSARA	10/12/2020 06:46	10/12/2020 16:37	10/12/2020 06:46	10/12/2020 16:37	9,84	4	39,35	CHI
20201253123	MUTUNOPOLIS	MU12354547	MARA ROSA	10/12/2020 06:47	10/12/2020 10:09	10/12/2020 06:47	10/12/2020 10:09	3,36	13	43,71	CHI
20201253129	TRINDADE	40095952	TRINDADE	10/12/2020 06:48	10/12/2020 14:35	10/12/2020 06:48	10/12/2020 14:35	7,78	1	7,78	CHI
20201253130	CAIAPONIA	CP11259376	CAIAPONIA	10/12/2020 06:48	10/12/2020 09:05	10/12/2020 06:48	10/12/2020 09:05	2,27	91	206,77	CHI
20201253131	JUSSARA	JR21013108	BRITANIA	10/12/2020 06:48	10/12/2020 10:04	10/12/2020 06:48	10/12/2020 10:04	3,25	3	9,76	CHI
20201253133	LUZIANIA	LZ21008840	VIANOPOLIS	10/12/2020 06:48	10/12/2020 09:30	10/12/2020 06:48	10/12/2020 09:30	2,69	1	2,69	CHI
20201253135	ANAPOLIS	20520890	ANAPOLIS UNIVERSITARIO S2	10/12/2020 06:48	10/12/2020 15:20	10/12/2020 06:48	10/12/2020 15:20	8,52	1	8,52	CHI
20201253144	BURITI ALEGRE	BG12263531	ALTO BURITI	10/12/2020 06:50	10/12/2020 11:01	10/12/2020 06:50	10/12/2020 11:01	4,17	6	25,03	CHI
20201254274	JOVIANIA	JV12052761	GOIATUBA S1	10/12/2020 06:50	10/12/2020 19:47	10/12/2020 06:50	10/12/2020 19:46	12,94	5	64,69	CHI
20201254274	JOVIANIA	JV12052761	GOIATUBA S1	10/12/2020 06:50	10/12/2020 19:47	10/12/2020 06:50	10/12/2020 19:47	12,96	1	12,96	CHI
20201255875	ITAPIRAPUA	IU12091645	MATRINCHA	10/12/2020 06:50	10/12/2020 16:06	10/12/2020 06:50	10/12/2020 16:06	9,26	9	83,38	CHI
20201250004	SANTA RITA DO ARAGUAIA	MY12303820	PARQUE DAS EMAS	10/12/2020 06:51	10/12/2020 10:54	10/12/2020 06:51	10/12/2020 10:54	4,05	2	8,11	CHI
20201250004	MINEIROS	MY12303820	PARQUE DAS EMAS	10/12/2020 06:51	10/12/2020 10:54	10/12/2020 06:51	10/12/2020 10:54	4,05	29	117,55	CHI
20201253147	TRINDADE	12353462	GOYA S2	10/12/2020 06:51	10/12/2020 09:06	10/12/2020 06:51	10/12/2020 09:06	2,25	1	2,25	CHI
20201253148	ESTRELA DO NORTE	ET21143706	MARA ROSA	10/12/2020 06:51	10/12/2020 13:31	10/12/2020 06:51	10/12/2020 13:31	6,67	1	6,67	CHI
20201254566	MARA ROSA	MQ12318474	SANTA TEREZINHA	10/12/2020 06:51	10/12/2020 12:53	10/12/2020 06:51	10/12/2020 12:53	6,03	6	36,15	CHI
20201253155	GOIANIA	GN12001049	XAVANTES	10/12/2020 06:52	10/12/2020 10:33	10/12/2020 06:52	10/12/2020 10:33	3,67	5	18,35	CHI
20201253157	SILVANIA	SV12112101	VIANOPOLIS	10/12/2020 06:53	10/12/2020 08:48	10/12/2020 06:53	10/12/2020 08:48	1,90	8	15,20	CHI
20201253161	CORREGO DO OURO	CO31057445	SAO LUIZ DOS MONTES BELOS	10/12/2020 06:54	10/12/2020 10:23	10/12/2020 06:54	10/12/2020 10:23	3,47	2	6,94	CHI
20201253163	MINEIROS	MY21302988	PARQUE DAS EMAS	10/12/2020 06:55	11/12/2020 10:55	10/12/2020 06:55	11/12/2020 10:55	28,00	1	28,00	CHI
20201253167	CORREGO DO OURO	CO21194073	SAO LUIZ DOS MONTES BELOS	10/12/2020 06:55	10/12/2020 10:41	10/12/2020 06:55	10/12/2020 10:41	3,75	1	3,75	CHI

20201253168	MINEIROS	MY12324341RE	PARQUE DAS EMAS	10/12/2020 06:55	10/12/2020 14:00	10/12/2020 06:55	10/12/2020 14:00	7,07	23	162,61	CHI
20201253172	RIO VERDE	BZ21159358	ACREUNA	10/12/2020 06:55	10/12/2020 13:40	10/12/2020 06:55	10/12/2020 13:40	6,74	1	6,74	CHI
20201253217	MINACU	IH12220680	MINACU	10/12/2020 06:56	10/12/2020 21:50	10/12/2020 06:56	10/12/2020 21:50	14,89	13	193,57	CHI
20201253640	PONTALINA	PK12090553	VICENTINOPOLIS	10/12/2020 06:56	10/12/2020 22:58	10/12/2020 06:56	10/12/2020 22:58	16,02	16	256,28	CHI
20201253682	ISRAELANDIA	FN12113974	IPORA	10/12/2020 06:56	10/12/2020 15:55	10/12/2020 06:56	10/12/2020 15:55	8,97	11	98,65	CHI
20201253682	FAZENDA NOVA	FN12113974	IPORA	10/12/2020 06:56	10/12/2020 15:55	10/12/2020 06:56	10/12/2020 15:55	8,97	17	152,46	CHI
20201253184	PIRENOPOLIS	PV21155058	CORUMBA	10/12/2020 06:57	10/12/2020 16:52	10/12/2020 06:57	10/12/2020 16:52	9,91	1	9,91	CHI
20201253187	PORTEIRAO	CL21230802	RIO DOS BOIS	10/12/2020 06:57	10/12/2020 18:52	10/12/2020 06:57	10/12/2020 18:52	11,90	1	11,90	CHI
20201253192	TRINDADE	16659454	GOYA S2	10/12/2020 06:58	10/12/2020 10:10	10/12/2020 06:58	10/12/2020 10:10	3,19	1	3,19	CHI
20201253652	MINACU	IH11135602	MINACU	10/12/2020 06:58	11/12/2020 13:25	10/12/2020 06:58	11/12/2020 13:25	30,44	68	2069,90	CHI
20201253203	MOZARLANDIA	MZ21135178	MOZARLANDIA	10/12/2020 06:59	10/12/2020 15:04	10/12/2020 06:59	10/12/2020 15:04	8,08	1	8,08	CHI
20201255498	IPAMERI	IP12404718	IPAMERI	10/12/2020 06:59	10/12/2020 17:09	10/12/2020 06:59	10/12/2020 17:09	10,17	2	20,33	CHI
20201253824	MARA ROSA	MQ12208421	MARA ROSA	10/12/2020 07:00	10/12/2020 10:35	10/12/2020 07:00	10/12/2020 10:35	3,57	14	49,96	CHI
20201253213	AMARALINA	MU11335296	MARA ROSA	10/12/2020 07:01	10/12/2020 09:36	10/12/2020 07:01	10/12/2020 09:36	2,58	2	5,17	CHI
20201253220	ITUMBIARA	IT16416788	ITUMBIARA NOVA	10/12/2020 07:02	10/12/2020 11:30	10/12/2020 07:02	10/12/2020 11:30	4,47	680	3039,22	CHI
20201253222	ANAPOLIS	20097281	JUNDIAI S2	10/12/2020 07:02	10/12/2020 12:08	10/12/2020 07:02	10/12/2020 12:08	5,09	1	5,09	CHI
20201253225	INHUMAS	IN21390931	INHUMAS S1	10/12/2020 07:02	10/12/2020 12:54	10/12/2020 07:02	10/12/2020 12:54	5,85	1	5,85	CHI
20201253495	JATAI	JT12324674	JATAI S2	10/12/2020 07:02	10/12/2020 14:32	10/12/2020 07:02	10/12/2020 14:32	7,50	14	105,02	CHI
20201254682	GOIATUBA	MR12190892	GOIATUBA S2	10/12/2020 07:02	10/12/2020 17:20	10/12/2020 07:02	10/12/2020 17:20	10,29	10	102,93	CHI
20201253858	SAO LUIZ DO NORTE	SZ12236801	BARRO ALTO	10/12/2020 07:03	10/12/2020 14:39	10/12/2020 07:03	10/12/2020 14:39	7,59	22	167,06	CHI
20201253238	NIQUELANDIA	NQ12315971	BARRO ALTO	10/12/2020 07:04	10/12/2020 09:03	10/12/2020 07:04	10/12/2020 09:03	1,97	13	25,60	CHI
20201253238	VILA PROPICIO	NQ12315971	BARRO ALTO	10/12/2020 07:04	10/12/2020 09:03	10/12/2020 07:04	10/12/2020 09:03	1,97	1	1,97	CHI
20201254407	GOIAS	GS12145730	ITABERAI S1	10/12/2020 07:04	10/12/2020 11:16	10/12/2020 07:04	10/12/2020 11:16	4,19	9	37,71	CHI
20201253243	COCALZINHO DE GOIAS	ZN12104981	AGUAS LINDAS DE GOIAS S2	10/12/2020 07:05	10/12/2020 11:19	10/12/2020 07:05	10/12/2020 11:19	4,23	3	12,70	CHI
20201253246	CRIXAS	CX21372078	RUBIATABA	10/12/2020 07:05	11/12/2020 11:50	10/12/2020 07:05	11/12/2020 11:50	28,75	1	28,75	CHI
20201253251	PLANALTINA	PI12322789	PLANALTINA	10/12/2020 07:05	10/12/2020 10:13	10/12/2020 07:05	10/12/2020 10:13	3,12	38	118,52	CHI
20201253419	ANICUNS	AC12259103	FIRMINOPOLIS S2	10/12/2020 07:05	10/12/2020 08:43	10/12/2020 07:05	10/12/2020 08:43	1,62	19	30,73	CHI
20201253256	MUNDO NOVO DE GOIAS	MH21035214	NOVA CRIXAS	10/12/2020 07:06	11/12/2020 00:05	10/12/2020 07:06	11/12/2020 00:05	16,97	1	16,97	CHI
20201253355	VICENTINOPOLIS	VI12071025	VICENTINOPOLIS	10/12/2020 07:06	10/12/2020 08:59	10/12/2020 07:06	10/12/2020 08:05	0,97	413	401,87	CHI
20201253355	VICENTINOPOLIS	VI12071025	VICENTINOPOLIS	10/12/2020 07:06	10/12/2020 08:59	10/12/2020 07:06	10/12/2020 08:59	1,88	143	268,88	CHI
20201253258	MINACU	IH11262531	MINACU	10/12/2020 07:07	11/12/2020 07:49	10/12/2020 07:07	11/12/2020 07:49	24,70	70	1729,00	CHI
20201253261	PARAUNA	PU21109610	PARAUNA	10/12/2020 07:07	10/12/2020 11:45	10/12/2020 07:07	10/12/2020 11:45	4,64	1	4,64	CHI
20201253275	GUARINOS	SG12363548	SANTA TEREZINHA	10/12/2020 07:08	10/12/2020 16:35	10/12/2020 07:08	10/12/2020 16:35	9,44	3	28,32	CHI
20201253283	NIQUELANDIA	NQ21262911	NIQUELANDIA SUBTRANSMISSAO	10/12/2020 07:09	10/12/2020 09:57	10/12/2020 07:09	10/12/2020 09:57	2,79	3	8,38	CHI
20201253284	INACIOLANDIA	ID31128249	QUIRINOPOLIS	10/12/2020 07:09	10/12/2020 11:28	10/12/2020 07:09	10/12/2020 11:28	4,31	2	8,62	CHI
20201253287	PLANALTINA	PI12085617RE	PLANALTINA	10/12/2020 07:09	10/12/2020 08:48	10/12/2020 07:09	10/12/2020 08:48	1,63	416	679,70	CHI
20201253643	GUARAITA	IK12299436	ITAPURANGA	10/12/2020 07:09	10/12/2020 11:11	10/12/2020 07:09	10/12/2020 11:11	4,03	15	60,42	CHI
20201253290	PORANGATU	PO12088718	PORANGATU	10/12/2020 07:10	10/12/2020 10:27	10/12/2020 07:10	10/12/2020 10:27	3,28	4	13,10	CHI
20201253507	QUIRINOPOLIS	QI12301523	QUIRINOPOLIS	10/12/2020 07:10	10/12/2020 10:23	10/12/2020 07:10	10/12/2020 10:23	3,21	3	9,62	CHI
20201253295	MINEIROS	MY21337100	PARQUE DAS EMAS	10/12/2020 07:11	10/12/2020 18:40	10/12/2020 07:11	10/12/2020 18:40	11,48	1	11,48	CHI
20201253494	ANAPOLIS	AN12258782	ANAPOLIS UNIVERSITARIO S2	10/12/2020 07:11	10/12/2020 11:51	10/12/2020 07:11	10/12/2020 11:51	4,66	19	88,49	CHI
20201253746	MORRINHOS	MR12263821	GOIATUBA S1	10/12/2020 07:11	10/12/2020 10:18	10/12/2020 07:11	10/12/2020 10:18	3,11	12	37,34	CHI
20201253746	JOVIANIA	MR12263821	GOIATUBA S1	10/12/2020 07:11	10/12/2020 10:18	10/12/2020 07:11	10/12/2020 10:18	3,11	5	15,56	CHI
20201254042	BARRO ALTO	DF12205803	GOIANESIA S1	10/12/2020 07:11	10/12/2020 11:06	10/12/2020 07:11	10/12/2020 11:06	3,91	6	23,44	CHI
20201254042	SANTA RITA DO NOVO DESTINO	DF12205803	GOIANESIA S1	10/12/2020 07:11	10/12/2020 11:06	10/12/2020 07:11	10/12/2020 11:06	3,91	10	39,06	CHI
20201254063	RUBIATABA	RB12244416	RUBIATABA	10/12/2020 07:11	10/12/2020 14:02	10/12/2020 07:11	10/12/2020 14:02	6,84	4	27,35	CHI
20201253201	IPAMERI	IP12195206	IPAMERI	10/12/2020 07:12	10/12/2020 13:32	10/12/2020 07:12	10/12/2020 13:32	6,32	13	82,22	CHI
20201253201	CALDAS NOVAS	IP12195206	IPAMERI	10/12/2020 07:12	10/12/2020 13:32	10/12/2020 07:12	10/12/2020 13:32	6,32	3	18,97	CHI
20201253310	BONOPOLIS	BX12136924	SAO MIGUEL DO ARAGUAIA	10/12/2020 07:13	10/12/2020 14:35	10/12/2020 07:13	10/12/2020 14:35	7,36	5	36,81	CHI
20201253318	PARANAIGUARA	PC12295756	CACHOEIRA ALTA	10/12/2020 07:14	10/12/2020 13:48	10/12/2020 07:14	10/12/2020 13:48	6,55	1	6,55	CHI
20201254531	LUZIANIA	LZ12137225	VIANOPOLIS	10/12/2020 07:14	10/12/2020 13:07	10/12/2020 07:14	10/12/2020 13:07	5,87	13	76,36	CHI

20201254615	SILVANIA	SV12284036	VIANOPOLIS	10/12/2020 07:14	10/12/2020 14:09	10/12/2020 07:14	10/12/2020 14:09	6,90	19	131,14	CHI
20201253324	SIMOLANDIA	SA12384201	IACIARA S2	10/12/2020 07:15	10/12/2020 11:57	10/12/2020 07:15	10/12/2020 11:57	4,69	2	9,38	CHI
20201253324	POSSE	SA12384201	IACIARA S2	10/12/2020 07:15	10/12/2020 11:57	10/12/2020 07:15	10/12/2020 11:57	4,69	20	93,80	CHI
20201253324	BURITINOPOLIS	SA12384201	IACIARA S2	10/12/2020 07:15	10/12/2020 11:57	10/12/2020 07:15	10/12/2020 11:57	4,69	1	4,69	CHI
20201253326	IPAMERI	IP21231428	IPAMERI	10/12/2020 07:15	10/12/2020 14:25	10/12/2020 07:15	10/12/2020 14:25	7,16	1	7,16	CHI
20201253328	TRINDADE	TR11111550	TRINDADE	10/12/2020 07:16	10/12/2020 09:03	10/12/2020 07:16	10/12/2020 09:03	1,78	183	325,59	CHI
20201253335	PORTELANDIA	MY21360834	PARQUE DAS EMAS	10/12/2020 07:17	10/12/2020 23:49	10/12/2020 07:17	10/12/2020 23:49	16,53	1	16,53	CHI
20201253516	SITIO D ABADIA	SI12302925	IACIARA S2	10/12/2020 07:17	10/12/2020 13:36	10/12/2020 07:17	10/12/2020 13:36	6,31	5	31,56	CHI
20201253343	ARAGUAPAZ	1780013283	GOIAS	10/12/2020 07:18	10/12/2020 13:50	10/12/2020 07:18	10/12/2020 13:50	6,52	1	6,52	CHI
20201253344	FORMOSO	FO21145114	MARA ROSA	10/12/2020 07:18	10/12/2020 20:08	10/12/2020 07:18	10/12/2020 20:08	12,82	2	25,64	CHI
20201253346	VILA PROPICIO	NQ12363553	BARRO ALTO	10/12/2020 07:18	10/12/2020 10:27	10/12/2020 07:18	10/12/2020 10:27	3,13	5	15,67	CHI
20201253346	NIQUELANDIA	NQ12363553	BARRO ALTO	10/12/2020 07:18	10/12/2020 10:27	10/12/2020 07:18	10/12/2020 10:27	3,13	5	15,67	CHI
20201253351	JATAI	JT21184037	JATAI S1	10/12/2020 07:20	10/12/2020 21:18	10/12/2020 07:20	10/12/2020 21:18	13,96	1	13,96	CHI
20201253352	IPAMERI	IP21107604	PIRES DO RIO S2	10/12/2020 07:20	10/12/2020 11:15	10/12/2020 07:20	10/12/2020 11:15	3,91	1	3,91	CHI
20201253353	ALOANDIA	AD21108958	GOIATUBA S1	10/12/2020 07:20	11/12/2020 07:44	10/12/2020 07:20	11/12/2020 07:44	24,39	1	24,39	CHI
20201253635	ITAPURANGA	IK12298409	ITAPURANGA	10/12/2020 07:21	10/12/2020 09:26	10/12/2020 07:21	10/12/2020 09:26	2,08	14	29,07	CHI
20201253367	CAMPO ALEGRE DE GOIAS	CM21267133	CAMPO ALEGRE DE GOIAS	10/12/2020 07:23	10/12/2020 13:20	10/12/2020 07:23	10/12/2020 13:20	5,94	1	5,94	CHI
20201253376	BALIZA	BH11334527	BOM JARDIM	10/12/2020 07:25	10/12/2020 10:00	10/12/2020 07:25	10/12/2020 10:00	2,58	1	2,58	CHI
20201253436	CACHOEIRA ALTA	CA12200649	CACHOEIRA ALTA	10/12/2020 07:25	10/12/2020 11:13	10/12/2020 07:25	10/12/2020 11:13	3,79	2	7,58	CHI
20201253380	DISTRITO FEDERAL	IO12000012RE	CATALAO S1	10/12/2020 07:26	10/12/2020 09:32	10/12/2020 07:26	10/12/2020 09:32	2,10	9	18,87	CHI
20201253380	DAVINOPOLIS	IO12000012RE	CATALAO S1	10/12/2020 07:26	10/12/2020 09:32	10/12/2020 07:26	10/12/2020 09:32	2,10	92	192,92	CHI
20201253612	NIQUELANDIA	NQ12295506	NIQUELANDIA SUBTRANSMISSAO	10/12/2020 07:26	10/12/2020 10:38	10/12/2020 07:26	10/12/2020 10:38	3,19	19	60,68	CHI
20201253387	GUAPO	GA21028770	GUAPO S2	10/12/2020 07:27	10/12/2020 12:08	10/12/2020 07:27	10/12/2020 12:08	4,68	2	9,36	CHI
20201251588	ALVORADA DO NORTE	AQ12257608	FLORES DE GOIAS	10/12/2020 07:29	10/12/2020 19:46	10/12/2020 07:29	10/12/2020 19:46	12,28	10	122,78	CHI
20201251588	IACIARA	AQ12257608	FLORES DE GOIAS	10/12/2020 07:29	10/12/2020 19:46	10/12/2020 07:29	10/12/2020 19:46	12,28	4	49,11	CHI
20201251588	POSSE	AQ12257608	FLORES DE GOIAS	10/12/2020 07:29	10/12/2020 19:46	10/12/2020 07:29	10/12/2020 19:46	12,28	2	24,56	CHI
20201253394	CRISTALINA	KR12313551	CRISTALINA S2	10/12/2020 07:29	10/12/2020 11:42	10/12/2020 07:29	10/12/2020 11:42	4,22	96	404,67	CHI
202012179335	GOIANIA	GN12345849	GOYA S1	10/12/2020 07:29	10/12/2020 09:41	10/12/2020 07:29	10/12/2020 09:41	2,20	190	417,58	CHI
20201253403	ARAGARCAS	AG11000012	ARAGARCAS	10/12/2020 07:30	10/12/2020 13:36	10/12/2020 07:30	10/12/2020 13:36	6,09	123	748,49	CHI
20201253783	CRISTALINA	KR12276279	CRISTALINA S2	10/12/2020 07:30	10/12/2020 12:53	10/12/2020 07:30	10/12/2020 12:53	5,38	15	80,71	CHI
20201253868	NOVA CRIXAS	NA12096364	NOVA CRIXAS	10/12/2020 07:31	11/12/2020 13:24	10/12/2020 07:31	11/12/2020 13:24	29,87	5	149,34	CHI
20201252668	INACIOLANDIA	ID12271589	CACHOEIRA DOURADA	10/12/2020 07:32	10/12/2020 09:58	10/12/2020 07:32	10/12/2020 09:58	2,43	16	38,87	CHI
20201253412	SANTA HELENA DE GOIAS	10016909451	IPEGUARI	10/12/2020 07:32	10/12/2020 09:29	10/12/2020 07:32	10/12/2020 09:29	1,95	1	1,95	CHI
20201253413	BELA VISTA DE GOIAS	BV21102407	BELA VISTA S1	10/12/2020 07:32	10/12/2020 09:14	10/12/2020 07:32	10/12/2020 09:14	1,70	1	1,70	CHI
20201253423	NAZARIO	NZ12003900	ANICUNS	10/12/2020 07:32	10/12/2020 10:11	10/12/2020 07:32	10/12/2020 10:11	2,63	12	31,61	CHI
20201253606	MUTUNOPOLIS	MU12075219	MARA ROSA	10/12/2020 07:32	10/12/2020 11:22	10/12/2020 07:32	10/12/2020 11:22	3,82	8	30,58	CHI
20201253606	ESTRELA DO NORTE	MU12075219	MARA ROSA	10/12/2020 07:32	10/12/2020 11:22	10/12/2020 07:32	10/12/2020 11:22	3,82	1	3,82	CHI
20201253425	CALDAS NOVAS	CN21298655	CALDAS NOVAS S2	10/12/2020 07:33	10/12/2020 09:38	10/12/2020 07:33	10/12/2020 09:38	2,09	1	2,09	CHI
20201253430	PORTELANDIA	PW21205295	PARQUE DAS EMAS	10/12/2020 07:33	10/12/2020 19:35	10/12/2020 07:33	10/12/2020 19:35	12,02	1	12,02	CHI
20201253435	ABADIANIA	AA12388792	DAIA S2	10/12/2020 07:34	10/12/2020 15:12	10/12/2020 07:34	10/12/2020 15:12	7,62	2	15,25	CHI
20201253445	MONTIVIDIU	MV21373903	MONTIVIDIU T	10/12/2020 07:34	12/12/2020 07:54	10/12/2020 07:34	12/12/2020 07:54	48,34	1	48,34	CHI
20201253735	SERRANOPOLIS	SX12390576	JATAI S1	10/12/2020 07:34	10/12/2020 14:00	10/12/2020 07:34	10/12/2020 14:00	6,43	10	64,29	CHI
20201253994	LAGOA SANTA	O3700224	CACHOEIRA ALTA	10/12/2020 07:34	11/12/2020 17:01	10/12/2020 17:57	10/12/2020 23:55	5,98	17	101,58	CHI
20201253994	ITAJA	O3700224	CACHOEIRA ALTA	10/12/2020 07:34	11/12/2020 17:01	10/12/2020 17:57	10/12/2020 23:55	5,98	35	209,14	CHI
20201253994	ITARUMA	O3700224	CACHOEIRA ALTA	10/12/2020 07:34	11/12/2020 17:01	10/12/2020 17:57	10/12/2020 23:55	5,98	3	17,93	CHI
20201253994	ITAJA	IJ13018063	CACHOEIRA ALTA	10/12/2020 07:34	11/12/2020 17:01	10/12/2020 17:57	11/12/2020 17:01	23,08	4	92,31	CHI
20201256233	ABADIANIA	350018601	DAIA S2	10/12/2020 07:34	10/12/2020 21:53	10/12/2020 07:34	10/12/2020 21:53	14,31	1	14,31	CHI
20201253440	NOVA AURORA	NE12306653	CATALAO S1	10/12/2020 07:35	10/12/2020 11:56	10/12/2020 07:35	10/12/2020 11:56	4,35	1	4,35	CHI
20201253442	GOIATUBA	8003116	BOM JESUS DE GOIAS	10/12/2020 07:35	11/12/2020 11:55	10/12/2020 07:35	11/12/2020 11:55	28,33	1	28,33	CHI
20201253449	GOIANIA	10003974349	GOYA S1	10/12/2020 07:35	10/12/2020 11:47	10/12/2020 07:35	10/12/2020 11:47	4,18	1	4,18	CHI
20201253752	CAIAPONIA	CP12395440	PALESTINA	10/12/2020 07:35	10/12/2020 10:11	10/12/2020 07:35	10/12/2020 10:11	2,59	18	46,64	CHI

20201253744	SANTA HELENA DE GOIAS	SH12010246	IPEGUARI	10/12/2020 07:36	10/12/2020 10:07	10/12/2020 07:36	10/12/2020 10:07	2,51	21	52,66	CHI
20201253767	PONTALINA	JV12218123	GOIATUBA S1	10/12/2020 07:36	10/12/2020 17:36	10/12/2020 07:36	10/12/2020 17:36	9,99	4	39,95	CHI
20201253465	CAMPINACU	UC21252827	PORANGATU	10/12/2020 07:37	10/12/2020 11:28	10/12/2020 07:37	10/12/2020 11:28	3,84	1	3,84	CHI
20201253592	PLANALTINA	PI12248809	PLANALTINA	10/12/2020 07:37	10/12/2020 11:16	10/12/2020 07:37	10/12/2020 11:16	3,65	5	18,23	CHI
20201253888	ITAGUARI	IC12220187	ITABERAI S1	10/12/2020 07:37	10/12/2020 19:21	10/12/2020 07:37	10/12/2020 19:21	11,72	10	117,23	CHI
20201254409	SERRANOPOLIS	MY12278397	PARQUE DAS EMAS	10/12/2020 07:37	10/12/2020 23:38	10/12/2020 07:37	10/12/2020 23:38	16,01	7	112,04	CHI
20201254409	MINEIROS	MY12278397	PARQUE DAS EMAS	10/12/2020 07:37	10/12/2020 23:38	10/12/2020 07:37	10/12/2020 23:38	16,01	5	80,03	CHI
20201253487	MARA ROSA	MQ12104649	MARA ROSA	10/12/2020 07:39	10/12/2020 11:24	10/12/2020 07:39	10/12/2020 11:24	3,74	4	14,95	CHI
20201253501	JATAI	SX12264387RE	JATAI S1	10/12/2020 07:39	11/12/2020 09:55	10/12/2020 07:39	11/12/2020 09:55	26,26	7	183,81	CHI
20201253501	SERRANOPOLIS	SX12264387RE	JATAI S1	10/12/2020 07:39	11/12/2020 09:55	10/12/2020 07:39	11/12/2020 09:55	26,26	23	603,94	CHI
20201253538	INACIOLANDIA	CD12000349	QUIRINOPOLIS	10/12/2020 07:39	10/12/2020 11:55	10/12/2020 07:39	10/12/2020 11:55	4,26	7	29,81	CHI
20201254242	CRISTALINA	KR12336415	CRISTALINA S2	10/12/2020 07:40	10/12/2020 10:59	10/12/2020 07:40	10/12/2020 10:59	3,31	19	62,82	CHI
20201255499	IPAMERI	IP12404715	IPAMERI	10/12/2020 07:40	10/12/2020 20:30	10/12/2020 07:40	10/12/2020 20:30	12,83	2	25,66	CHI
20201252866	PORANGATU	PO12202569	PORANGATU	10/12/2020 07:42	10/12/2020 10:06	10/12/2020 07:42	10/12/2020 10:06	2,39	7	16,74	CHI
20201253511	PORANGATU	PO12371059	PORANGATU	10/12/2020 07:42	10/12/2020 08:26	10/12/2020 07:42	10/12/2020 08:26	0,73	53	38,75	CHI
20201253515	SAO FRANCISCO DE GOIAS	SF21381360	SAO FRANCISCO DE GOIAS	10/12/2020 07:42	10/12/2020 13:51	10/12/2020 07:42	10/12/2020 13:51	6,15	1	6,15	CHI
20201253533	MARA ROSA	FO21115554	MARA ROSA	10/12/2020 07:42	10/12/2020 15:51	10/12/2020 07:42	10/12/2020 15:51	8,13	1	8,13	CHI
20201253662	IPIRANGA DE GOIAS	RB12003338	RUBIATABA	10/12/2020 07:42	10/12/2020 17:17	10/12/2020 07:42	10/12/2020 17:17	9,58	1	9,58	CHI
20201253662	RUBIATABA	RB12003338	RUBIATABA	10/12/2020 07:42	10/12/2020 17:17	10/12/2020 07:42	10/12/2020 17:17	9,58	126	1207,18	CHI
20201253662	ITAPACI	RB12003338	RUBIATABA	10/12/2020 07:42	10/12/2020 17:17	10/12/2020 07:42	10/12/2020 17:17	9,58	10	95,81	CHI
20201254294	JATAI	JT12260285	JATAI S3	10/12/2020 07:42	10/12/2020 19:53	10/12/2020 07:42	10/12/2020 19:53	12,18	3	36,54	CHI
20201253535	CATALAO	IP12234083	IPAMERI	10/12/2020 07:43	10/12/2020 11:52	10/12/2020 07:43	10/12/2020 11:52	4,14	2	8,28	CHI
20201254845	INACIOLANDIA	IT12025051	CACHOEIRA DOURADA	10/12/2020 07:44	10/12/2020 14:28	10/12/2020 07:44	10/12/2020 14:28	6,72	5	33,60	CHI
20201255306	PORTELANDIA	PW12219564	PARQUE DAS EMAS	10/12/2020 07:44	10/12/2020 14:09	10/12/2020 07:44	10/12/2020 14:09	6,41	12	76,88	CHI
20201255306	MINEIROS	PW12219564	PARQUE DAS EMAS	10/12/2020 07:44	10/12/2020 14:09	10/12/2020 07:44	10/12/2020 14:09	6,41	7	44,84	CHI
20201253546	ARAGARCAS	AG21395936	ARAGARCAS	10/12/2020 07:45	10/12/2020 13:25	10/12/2020 07:45	10/12/2020 13:25	5,66	1	5,66	CHI
20201253552	ESTRELA DO NORTE	ET21181733	MARA ROSA	10/12/2020 07:45	10/12/2020 13:26	10/12/2020 07:45	10/12/2020 13:26	5,68	1	5,68	CHI
20201253556	DIORAMA	1530003638	IPORA	10/12/2020 07:45	10/12/2020 14:10	10/12/2020 07:45	10/12/2020 14:10	6,42	1	6,42	CHI
20201253828	MARA ROSA	MQ12236294	MARA ROSA	10/12/2020 07:45	10/12/2020 11:49	10/12/2020 07:45	10/12/2020 11:49	4,06	4	16,23	CHI
20201254687	LUZIANIA	LZ12313691	CRISTALINA S2	10/12/2020 07:45	10/12/2020 13:14	10/12/2020 07:45	10/12/2020 13:14	5,47	21	114,85	CHI
20201253561	VALPARAISO DE GOIAS	10025247911	MARAJOARA	10/12/2020 07:47	10/12/2020 10:03	10/12/2020 07:47	10/12/2020 10:03	2,26	1	2,26	CHI
20201253562	ITUMBIARA	IT121000144	PARANAIBA	10/12/2020 07:47	10/12/2020 09:36	10/12/2020 07:47	10/12/2020 09:36	1,81	1	1,81	CHI
20201254965	SITIO D ABADIA	SI10409697	IACIARA S2	10/12/2020 07:47	10/12/2020 13:15	10/12/2020 07:47	10/12/2020 13:15	5,47	240	1312,80	CHI
20201254965	DAMIANOPOLIS	SI10409697	IACIARA S2	10/12/2020 07:47	10/12/2020 13:15	10/12/2020 07:47	10/12/2020 13:15	5,47	36	196,92	CHI
20201256086	NOVA CRIXAS	8570019582	NOVA CRIXAS	10/12/2020 07:47	10/12/2020 17:22	10/12/2020 07:47	10/12/2020 17:22	9,57	1	9,57	CHI
20201253568	CRIXAS	CX11394916	RUBIATABA	10/12/2020 07:48	10/12/2020 10:57	10/12/2020 07:48	10/12/2020 10:57	3,15	1	3,15	CHI
20201253569	GOIANIA	11017545	FERROVIARIO S3	10/12/2020 07:48	10/12/2020 09:50	10/12/2020 07:48	10/12/2020 09:50	2,03	1	2,03	CHI
20201253576	NOVA CRIXAS	NA12375099	NOVA CRIXAS	10/12/2020 07:48	11/12/2020 10:49	10/12/2020 07:48	11/12/2020 10:49	27,00	5	135,00	CHI
20201256022	DAMOLANDIA	DL12319228	INHUMAS S1	10/12/2020 07:48	10/12/2020 16:47	10/12/2020 07:48	10/12/2020 16:47	8,98	2	17,96	CHI
20201256022	OURO VERDE DE GOIAS	DL12319228	INHUMAS S1	10/12/2020 07:48	10/12/2020 16:47	10/12/2020 07:48	10/12/2020 16:47	8,98	4	35,92	CHI
20201253580	PLANALTINA	PI12302894	PLANALTINA	10/12/2020 07:49	10/12/2020 12:05	10/12/2020 07:49	10/12/2020 12:05	4,26	1	4,26	CHI
20201253581	PIRES DO RIO	PR21017118	PIRES DO RIO S1	10/12/2020 07:49	10/12/2020 11:56	10/12/2020 07:49	10/12/2020 11:56	4,11	2	8,22	CHI
20201253585	JARAGUA	JA21297948	JARAGUA	10/12/2020 07:49	10/12/2020 23:44	10/12/2020 07:49	10/12/2020 23:44	15,90	1	15,90	CHI
20201253588	SILVANIA	SV12358037	BELA VISTA S2	10/12/2020 07:50	10/12/2020 09:57	10/12/2020 07:50	10/12/2020 09:57	2,10	3	6,30	CHI
20201253589	SENADOR CANEDO	190093730	SENADOR CANEDO	10/12/2020 07:51	10/12/2020 09:09	10/12/2020 07:51	10/12/2020 09:09	1,30	1	1,30	CHI
20201253605	CABECEIRAS	CW21264717	ITUIQUIRA	10/12/2020 07:53	10/12/2020 17:10	10/12/2020 07:53	10/12/2020 17:10	9,28	1	9,28	CHI
20201253613	CACHOEIRA ALTA	1090000604	CACHOEIRA ALTA	10/12/2020 07:54	10/12/2020 09:15	10/12/2020 07:54	10/12/2020 09:15	1,34	1	1,34	CHI
20201253615	GOIANAPOLIS	GP21353395	DAIA S2	10/12/2020 07:55	10/12/2020 11:28	10/12/2020 07:55	10/12/2020 11:28	3,55	1	3,55	CHI
20201253619	SAO JOAO D ALIANCA	JL21348101	SAO JOAO D ALIANCA	10/12/2020 07:55	10/12/2020 11:11	10/12/2020 07:55	10/12/2020 11:11	3,25	1	3,25	CHI
20201254677	SANTA TEREZINHA DE GOIAS	SG12380710	SANTA TEREZINHA	10/12/2020 07:55	11/12/2020 16:40	10/12/2020 07:55	11/12/2020 16:40	32,75	8	261,99	CHI
20201251979	ITAGUARU	UA10395399	ITAPURANGA	10/12/2020 07:56	12/12/2020 12:55	10/12/2020 07:56	12/12/2020 00:37	40,68	4	162,72	CHI

20201251979	HEITORAI	UA10395399	ITAPURANGA	10/12/2020 07:56	12/12/2020 12:55	10/12/2020 07:56	12/12/2020 00:37	40,68	4	162,72	CHI
20201251979	HEITORAI	UA13395399B	ITAPURANGA	10/12/2020 07:56	12/12/2020 12:55	12/12/2020 01:00	12/12/2020 01:03	0,06	4	0,24	CHI
20201251979	ITAGUARU	UA13395399B	ITAPURANGA	10/12/2020 07:56	12/12/2020 12:55	12/12/2020 01:00	12/12/2020 01:03	0,06	4	0,24	CHI
20201251979	HEITORAI	03530214	ITAPURANGA	10/12/2020 07:56	12/12/2020 12:55	12/12/2020 01:05	12/12/2020 01:13	0,13	1453	191,31	CHI
20201251979	ITAGUARU	03530214	ITAPURANGA	10/12/2020 07:56	12/12/2020 12:55	12/12/2020 01:05	12/12/2020 01:13	0,13	12	1,58	CHI
20201251979	ITAPURANGA	03530214	ITAPURANGA	10/12/2020 07:56	12/12/2020 12:55	12/12/2020 01:05	12/12/2020 01:13	0,13	1	0,13	CHI
20201251979	ITAGUARU	UA13395399B	ITAPURANGA	10/12/2020 07:56	12/12/2020 12:55	12/12/2020 01:05	12/12/2020 04:02	2,96	4	11,84	CHI
20201251979	HEITORAI	UA13395399B	ITAPURANGA	10/12/2020 07:56	12/12/2020 12:55	12/12/2020 01:05	12/12/2020 04:02	2,96	4	11,84	CHI
20201251979	ITAGUARU	UA10395399	ITAPURANGA	10/12/2020 07:56	12/12/2020 12:55	10/12/2020 07:56	12/12/2020 04:33	44,62	39	1740,16	CHI
20201251979	URUANA	UA10395399	ITAPURANGA	10/12/2020 07:56	12/12/2020 12:55	10/12/2020 07:56	12/12/2020 04:33	44,62	1	44,62	CHI
20201251979	ITAGUARU	IC12036344	ITAPURANGA	10/12/2020 07:56	12/12/2020 12:55	10/12/2020 07:56	12/12/2020 09:27	49,51	1	49,51	CHI
20201251979	ITAPURANGA	IC12036344	ITAPURANGA	10/12/2020 07:56	12/12/2020 12:55	10/12/2020 07:56	12/12/2020 09:27	49,51	75	3712,92	CHI
20201251979	HEITORAI	IC12036344	ITAPURANGA	10/12/2020 07:56	12/12/2020 12:55	10/12/2020 15:20	12/12/2020 09:27	42,12	3	126,35	CHI
20201251979	HEITORAI	IC12036344	ITAPURANGA	10/12/2020 07:56	12/12/2020 12:55	12/12/2020 08:50	12/12/2020 09:27	0,62	1	0,62	CHI
20201251979	ITAGUARU	IC12036344	ITAPURANGA	10/12/2020 07:56	12/12/2020 12:55	12/12/2020 08:50	12/12/2020 09:27	0,62	2	1,23	CHI
20201251979	HEITORAI	UA12156674	ITAPURANGA	10/12/2020 07:56	12/12/2020 12:55	10/12/2020 07:56	12/12/2020 12:55	52,97	1	52,97	CHI
20201253623	PORANGATU	PO12252098	PORANGATU	10/12/2020 07:56	10/12/2020 11:28	10/12/2020 07:56	10/12/2020 11:28	3,53	5	17,64	CHI
20201253631	FORMOSA	FA21194799	ITUIQUIRA	10/12/2020 07:57	10/12/2020 15:13	10/12/2020 07:57	10/12/2020 15:13	7,26	1	7,26	CHI
20201253632	CATALAO	1990128510	CATALAO S2	10/12/2020 07:57	10/12/2020 12:10	10/12/2020 07:57	10/12/2020 12:10	4,21	1	4,21	CHI
20201254392	INACIOLANDIA	ID11304158	CACHOEIRA DOURADA	10/12/2020 07:57	10/12/2020 15:00	10/12/2020 07:57	10/12/2020 15:00	7,04	1	7,04	CHI
20201253641	ITABERAI	IX21293436	INHUMAS S1	10/12/2020 07:58	10/12/2020 14:48	10/12/2020 07:58	10/12/2020 14:48	6,83	1	6,83	CHI
20201254659	CAMPO ALEGRE DE GOIAS	CM12077548	CAMPO ALEGRE DE GOIAS	10/12/2020 07:58	10/12/2020 16:38	10/12/2020 07:58	10/12/2020 16:38	8,65	6	51,91	CHI
20201253646	BALIZA	BM21369816	BOM JARDIM	10/12/2020 07:59	10/12/2020 08:52	10/12/2020 07:59	10/12/2020 08:52	0,88	1	0,88	CHI
20201253654	EDEIA	EA12086936	EDEIA	10/12/2020 07:59	10/12/2020 09:56	10/12/2020 07:59	10/12/2020 09:56	1,94	2	3,88	CHI
20201253658	DOVERLANDIA	DV21151190	CAIAPONIA	10/12/2020 07:59	10/12/2020 09:02	10/12/2020 07:59	10/12/2020 09:02	1,03	1	1,03	CHI
20201254427	PORANGATU	PO12100815	NOVO PLANALTO	10/12/2020 07:59	10/12/2020 17:46	10/12/2020 07:59	10/12/2020 17:46	9,78	3	29,34	CHI
20201253670	PALESTINA DE GOIAS	PY21021360	PALESTINA	10/12/2020 08:01	10/12/2020 11:36	10/12/2020 08:01	10/12/2020 11:36	3,58	2	7,16	CHI
20201253676	GOIANIA	GN11275002	CARAJAS S1	10/12/2020 08:01	10/12/2020 11:04	10/12/2020 08:01	10/12/2020 11:04	3,04	72	218,54	CHI
20201254377	PIRACANJUBA	PJ12000114	CALDAS NOVAS S1	10/12/2020 08:01	10/12/2020 13:54	10/12/2020 08:01	10/12/2020 13:54	5,87	13	76,27	CHI
20201253679	GOIANIA	12904855	GOYA S2	10/12/2020 08:02	10/12/2020 09:55	10/12/2020 08:02	10/12/2020 09:55	1,88	1	1,88	CHI
20201255111	CORUMBAIBA	CI12062859	VILA CORUMBA	10/12/2020 08:02	10/12/2020 20:37	10/12/2020 08:02	10/12/2020 20:37	12,57	20	251,39	CHI
20201253690	ALEXANIA	AX21070957	ALEXANIA	10/12/2020 08:03	10/12/2020 13:23	10/12/2020 08:03	10/12/2020 13:23	5,33	1	5,33	CHI
20201253691	JATAI	JT21214325	JATAI S2	10/12/2020 08:03	10/12/2020 22:04	10/12/2020 08:03	10/12/2020 22:04	14,01	1	14,01	CHI
20201253692	FORMOSA	FA11269907	ITUIQUIRA	10/12/2020 08:03	11/12/2020 10:13	10/12/2020 08:03	11/12/2020 10:13	26,16	1	26,16	CHI
20201253695	JUSSARA	JR21364773	BRITANIA	10/12/2020 08:03	10/12/2020 11:00	10/12/2020 08:03	10/12/2020 11:00	2,94	1	2,94	CHI
20201254670	CARMO DO RIO VERDE	IK12170874	ITAPURANGA	10/12/2020 08:03	10/12/2020 15:29	10/12/2020 08:03	10/12/2020 15:29	7,43	12	89,15	CHI
20201254785	BRITANIA	BT12009771	BRITANIA	10/12/2020 08:03	10/12/2020 12:34	10/12/2020 08:03	10/12/2020 12:34	4,50	18	81,03	CHI
20201254910	ORIZONA	OZ12052363	PIRES DO RIO S2	10/12/2020 08:03	12/12/2020 10:15	10/12/2020 08:03	12/12/2020 10:15	50,20	6	301,20	CHI
20201254387	ITUMBIARA	IT12222546	PARANAIBA	10/12/2020 08:04	10/12/2020 21:18	10/12/2020 08:04	10/12/2020 21:18	13,22	23	304,02	CHI
20201253711	SERRANOPOLIS	SX21254096	JATAI S1	10/12/2020 08:05	10/12/2020 22:12	10/12/2020 08:05	10/12/2020 22:12	14,11	1	14,11	CHI
20201253717	GUARAITA	GS12065407	GOIAS	10/12/2020 08:06	10/12/2020 10:50	10/12/2020 08:06	10/12/2020 10:50	2,73	1	2,73	CHI
20201253717	ITAPURANGA	GS12065407	GOIAS	10/12/2020 08:06	10/12/2020 10:50	10/12/2020 08:06	10/12/2020 10:50	2,73	2	5,47	CHI
20201253717	GOIAS	GS12065407	GOIAS	10/12/2020 08:06	10/12/2020 10:50	10/12/2020 08:06	10/12/2020 10:50	2,73	1	2,73	CHI
20201253968	VILA PROPICIO	NP12231823	GOIANESIA S1	10/12/2020 08:06	10/12/2020 10:57	10/12/2020 08:06	10/12/2020 10:57	2,85	18	51,26	CHI
20201254205	MONTES CLAROS DE GOIAS	ME12228195	IPORA	10/12/2020 08:06	10/12/2020 14:07	10/12/2020 08:06	10/12/2020 14:07	6,00	6	36,03	CHI
20201253728	CATURAI	CK21018555	INHUMAS S1	10/12/2020 08:07	10/12/2020 21:17	10/12/2020 08:07	10/12/2020 21:17	13,16	1	13,16	CHI
20201253729	NOVO PLANALTO	TA11172385	NOVO PLANALTO	10/12/2020 08:07	10/12/2020 11:50	10/12/2020 08:07	10/12/2020 11:50	3,72	24	89,31	CHI
20201253730	VIANOPOLIS	VN21151108	VIANOPOLIS	10/12/2020 08:07	10/12/2020 13:00	10/12/2020 08:07	10/12/2020 13:00	4,87	1	4,87	CHI
20201253734	JATAI	JT12248490	JATAI S1	10/12/2020 08:07	10/12/2020 14:45	10/12/2020 08:07	10/12/2020 14:45	6,62	6	39,71	CHI
20201255625	PORANGATU	PO12350109	PORANGATU	10/12/2020 08:07	10/12/2020 15:57	10/12/2020 08:07	10/12/2020 15:57	7,83	11	86,17	CHI
20201253738	MINACU	IH12320901	MINACU	10/12/2020 08:08	10/12/2020 15:16	10/12/2020 08:08	10/12/2020 15:16	7,13	4	28,51	CHI

20201253742	CACU	CC21191672	CACHOEIRA ALTA	10/12/2020 08:09	10/12/2020 10:48	10/12/2020 08:09	10/12/2020 10:48	2,65	1	2,65	CHI
20201253743	CABECEIRAS	CW21181823	ITUIQUIRA	10/12/2020 08:09	10/12/2020 14:23	10/12/2020 08:09	10/12/2020 14:23	6,23	1	6,23	CHI
20201253756	NOVO GAMA	2460212600	PACAEMBU S1	10/12/2020 08:10	10/12/2020 11:05	10/12/2020 08:10	10/12/2020 11:05	2,90	1	2,90	CHI
20201253764	GOIANIA	12434498	GOIANIA LESTE S1	10/12/2020 08:11	10/12/2020 09:41	10/12/2020 08:11	10/12/2020 09:41	1,49	1	1,49	CHI
20201253766	INDIARA	JD12391452	PALMEIRAS	10/12/2020 08:11	10/12/2020 11:00	10/12/2020 08:11	10/12/2020 11:00	2,80	5	14,01	CHI
20201253766	JANDAIA	JD12391452	PALMEIRAS	10/12/2020 08:11	10/12/2020 11:00	10/12/2020 08:11	10/12/2020 11:00	2,80	4	11,21	CHI
20201255364	MONTES CLAROS DE GOIAS	ME12204903	IPORA	10/12/2020 08:11	10/12/2020 12:54	10/12/2020 08:11	10/12/2020 12:54	4,71	3	14,12	CHI
20201253774	ORIZONA	7920002034	PIRES DO RIO S2	10/12/2020 08:12	10/12/2020 12:32	10/12/2020 08:12	10/12/2020 12:32	4,32	1	4,32	CHI
20201253791	APARECIDA DE GOIANIA	10010509923	ATLANTICO S2	10/12/2020 08:14	10/12/2020 10:34	10/12/2020 08:14	10/12/2020 10:34	2,32	1	2,32	CHI
20201253792	SANTA HELENA DE GOIAS	SH21000257	IPEGUARI	10/12/2020 08:14	10/12/2020 13:18	10/12/2020 08:14	10/12/2020 13:18	5,05	1	5,05	CHI
20201253795	GOIANIA	10004567755	SENADOR CANEDO	10/12/2020 08:15	10/12/2020 12:44	10/12/2020 08:15	10/12/2020 12:44	4,48	1	4,48	CHI
20201253800	CATALAO	CT12338782	CATALAO S1	10/12/2020 08:15	10/12/2020 10:26	10/12/2020 08:15	10/12/2020 10:26	2,17	28	60,77	CHI
20201253801	RIO VERDE	RV12260611	CABRIUVA S1	10/12/2020 08:15	10/12/2020 10:20	10/12/2020 08:15	10/12/2020 10:20	2,07	1	2,07	CHI
20201254660	MONTE ALEGRE DE GOIAS	MA12105998	SAO DOMINGOS	10/12/2020 08:15	10/12/2020 17:02	10/12/2020 08:15	10/12/2020 17:02	8,77	17	149,07	CHI
20201253806	APORE	AE12038636	ITAJA S1	10/12/2020 08:16	10/12/2020 19:20	10/12/2020 08:16	10/12/2020 19:20	11,07	2	22,13	CHI
20201253806	DISTRITO FEDERAL	AE12038636	ITAJA S1	10/12/2020 08:16	10/12/2020 19:20	10/12/2020 08:16	10/12/2020 19:20	11,07	2	22,13	CHI
20201254697	BOM JARDIM DE GOIAS	BM12374933	BOM JARDIM	10/12/2020 08:16	10/12/2020 11:38	10/12/2020 08:16	10/12/2020 11:38	3,36	6	20,15	CHI
20201256106	OURO VERDE DE GOIAS	OV12033148	NEROPOLIS S1	10/12/2020 08:16	10/12/2020 16:33	10/12/2020 08:16	10/12/2020 16:33	8,27	4	33,07	CHI
20201256106	CAMPO LIMPO	OV12033148	NEROPOLIS S1	10/12/2020 08:16	10/12/2020 16:33	10/12/2020 08:16	10/12/2020 16:33	8,27	3	24,80	CHI
20201253832	CRIXAS	CX11394918	RUBIATABA	10/12/2020 08:19	10/12/2020 11:33	10/12/2020 08:19	10/12/2020 11:33	3,23	1	3,23	CHI
20201253833	NOVA CRIXAS	8570021795	NOVA CRIXAS	10/12/2020 08:19	10/12/2020 09:42	10/12/2020 08:19	10/12/2020 09:42	1,38	1	1,38	CHI
20201253983	PIRACANJUBA	PJ12013344	MORRINHOS	10/12/2020 08:20	10/12/2020 11:49	10/12/2020 08:20	10/12/2020 11:49	3,48	12	41,77	CHI
20201253846	SITIO D ABADIA	AQ12344369	IACIARA S2	10/12/2020 08:21	10/12/2020 12:11	10/12/2020 08:21	10/12/2020 12:11	3,83	3	11,50	CHI
20201253851	IACIARA	IA12132252	IACIARA S2	10/12/2020 08:21	10/12/2020 19:18	10/12/2020 08:21	10/12/2020 19:18	10,94	2	21,88	CHI
20201253855	CATALAO	CT12266071	CATALAO S1	10/12/2020 08:22	10/12/2020 09:39	10/12/2020 08:22	10/12/2020 09:39	1,28	1	1,28	CHI
20201253856	SAO MIGUEL DO PASSA QUATRO	SQ21207491	BELA VISTA S2	10/12/2020 08:22	10/12/2020 10:42	10/12/2020 08:22	10/12/2020 10:42	2,33	1	2,33	CHI
20201253857	SANTA RITA DO ARAGUAIA	SU11148199	SANTA RITA DO ARAGUAIA	10/12/2020 08:22	10/12/2020 09:13	10/12/2020 08:22	10/12/2020 09:13	0,84	45	37,95	CHI
20201253863	CACU	CC21033599	CACHOEIRA ALTA	10/12/2020 08:23	11/12/2020 08:44	10/12/2020 08:23	11/12/2020 08:44	24,34	2	48,68	CHI
20201253869	JATAI	JT21182234	JATAI S1	10/12/2020 08:24	11/12/2020 09:32	10/12/2020 08:24	11/12/2020 09:32	25,12	1	25,12	CHI
20201253871	NIQUELANDIA	NQ12056787RE	URUACU	10/12/2020 08:24	10/12/2020 11:32	10/12/2020 08:24	10/12/2020 11:32	3,12	62	193,63	CHI
20201256766	JARAGUA	JA12278881	JARAGUA	10/12/2020 08:24	10/12/2020 17:32	10/12/2020 08:24	10/12/2020 17:32	9,12	12	109,49	CHI
20201253883	ALVORADA DO NORTE	AQ21068782	FLORES DE GOIAS	10/12/2020 08:25	10/12/2020 20:21	10/12/2020 08:25	10/12/2020 20:21	11,92	1	11,92	CHI
20201253946	CATALAO	CT11358410	CATALAO S2	10/12/2020 08:25	10/12/2020 09:33	10/12/2020 08:25	10/12/2020 09:33	1,13	58	65,44	CHI
20201255004	MINEIROS	MY12194493	PARQUE DAS EMAS	10/12/2020 08:26	11/12/2020 09:55	10/12/2020 08:26	11/12/2020 09:55	25,47	5	127,35	CHI
20201253894	FLORES DE GOIAS	FB21386728	IACIARA S2	10/12/2020 08:27	10/12/2020 14:35	10/12/2020 08:27	10/12/2020 14:35	6,13	1	6,13	CHI
20201253898	ORIZONA	2060018657	PIRES DO RIO S2	10/12/2020 08:28	11/12/2020 02:25	10/12/2020 08:28	11/12/2020 02:25	17,95	1	17,95	CHI
20201253899	INDIARA	10004997733	EDEIA	10/12/2020 08:28	10/12/2020 17:46	10/12/2020 08:28	10/12/2020 17:46	9,29	1	9,29	CHI
20201253908	SANTO ANTONIO DO DESCOBERTO	SN12313924	MARAJOARA	10/12/2020 08:29	10/12/2020 11:33	10/12/2020 08:29	10/12/2020 11:33	3,06	5	15,28	CHI
20201253915	BONOPOLIS	BX12328842	NOVO PLANALTO	10/12/2020 08:30	10/12/2020 10:33	10/12/2020 08:30	10/12/2020 10:33	2,04	1	2,04	CHI
20201253917	JARAGUA	JA12026047	JARAGUA	10/12/2020 08:30	10/12/2020 08:49	10/12/2020 08:30	10/12/2020 08:49	0,32	6	1,89	CHI
20201254055	QUIRINOPOLIS	QI12402325	QUIRINOPOLIS	10/12/2020 08:30	10/12/2020 13:06	10/12/2020 08:30	10/12/2020 13:06	4,59	15	68,89	CHI
20201253921	ARAGUAPAZ	AZ12336266	GOIAS	10/12/2020 08:31	10/12/2020 11:54	10/12/2020 08:31	10/12/2020 11:54	3,38	5	16,89	CHI
20201253924	FORMOSO	FO12185324	PORANGATU	10/12/2020 08:31	10/12/2020 14:17	10/12/2020 08:31	10/12/2020 14:17	5,76	2	11,51	CHI
20201253926	JATAI	JT11377808	JATAI S2	10/12/2020 08:31	10/12/2020 11:35	10/12/2020 08:31	10/12/2020 11:35	3,05	1	3,05	CHI
20201254874	JARAGUA	JA12414669	JARAGUA	10/12/2020 08:31	10/12/2020 14:16	10/12/2020 08:31	10/12/2020 14:16	5,75	214	1229,67	CHI
20201254025	CALDAS NOVAS	PJ12263230	CALDAS NOVAS S1	10/12/2020 08:32	10/12/2020 13:39	10/12/2020 08:32	10/12/2020 13:39	5,11	1	5,11	CHI
20201254025	PIRACANJUBA	PJ12263230	CALDAS NOVAS S1	10/12/2020 08:32	10/12/2020 13:39	10/12/2020 08:32	10/12/2020 13:39	5,11	17	86,86	CHI
20201254075	RIO VERDE	RV12154033	MONTIVIDIU T	10/12/2020 08:32	10/12/2020 13:53	10/12/2020 08:32	10/12/2020 13:53	5,34	15	80,10	CHI
20201254449	TROMBAS	MX12187848	PORANGATU	10/12/2020 08:33	10/12/2020 09:54	10/12/2020 08:33	10/12/2020 09:54	1,33	1	1,33	CHI
20201254449	MONTIVIDIU DO NORTE	MX12187848	PORANGATU	10/12/2020 08:33	10/12/2020 09:54	10/12/2020 08:33	10/12/2020 09:54	1,33	15	20,00	CHI
20201253951	NOVA CRIXAS	NA12307152	MOZARLANDIA	10/12/2020 08:34	10/12/2020 15:38	10/12/2020 08:34	10/12/2020 15:38	7,07	1	7,07	CHI

20201253953	PIRACANJUBA	PJ21091813	PIRACANJUBA	10/12/2020 08:34	10/12/2020 13:57	10/12/2020 08:34	10/12/2020 13:57	5,38	3	16,13	CHI
20201253954	JUSSARA	JR21138781	JUSSARA	10/12/2020 08:34	10/12/2020 15:12	10/12/2020 08:34	10/12/2020 15:12	6,62	1	6,62	CHI
20201253962	SILVANIA	SV21339167	DAIA S2	10/12/2020 08:34	10/12/2020 10:31	10/12/2020 08:34	10/12/2020 10:31	1,93	1	1,93	CHI
20201253964	BONOPOLIS	BX21265447	SAO MIGUEL DO ARAGUAIA	10/12/2020 08:35	10/12/2020 10:37	10/12/2020 08:35	10/12/2020 10:37	2,03	3	6,09	CHI
20201253978	MAIRIPOTABA	PK31045945	PONTALINA	10/12/2020 08:36	11/12/2020 09:09	10/12/2020 08:36	11/12/2020 09:09	24,54	1	24,54	CHI
20201253980	PALMEIRAS DE GOIAS	PL16432480	PALMEIRAS	10/12/2020 08:36	10/12/2020 15:51	10/12/2020 08:36	10/12/2020 11:39	3,04	50	152,03	CHI
20201253980	PALMEIRAS DE GOIAS	PL13006138	PALMEIRAS	10/12/2020 08:36	10/12/2020 15:51	10/12/2020 08:36	10/12/2020 15:51	7,24	46	333,16	CHI
20201253980	PALMEIRAS DE GOIAS	PL13006138	PALMEIRAS	10/12/2020 08:36	10/12/2020 15:51	10/12/2020 12:11	10/12/2020 15:51	3,67	72	263,98	CHI
20201253984	MUTUNOPOLIS	MU21000002	MARA ROSA	10/12/2020 08:36	10/12/2020 11:30	10/12/2020 08:36	10/12/2020 11:30	2,89	1	2,89	CHI
20201253997	URUACU	CR12405404	MARA ROSA	10/12/2020 08:38	10/12/2020 13:55	10/12/2020 08:38	10/12/2020 13:55	5,28	13	68,59	CHI
20201254001	QUIRINOPOLIS	QI31134048	QUIRINOPOLIS	10/12/2020 08:38	10/12/2020 12:35	10/12/2020 08:38	10/12/2020 12:35	3,94	1	3,94	CHI
20201254004	URUACU	UR12398011	URUACU	10/12/2020 08:38	10/12/2020 09:50	10/12/2020 08:38	10/12/2020 09:50	1,19	4	4,74	CHI
20201254133	LUZIANIA	LZ12016676	RIO VERMELHO	10/12/2020 08:38	10/12/2020 10:56	10/12/2020 08:38	10/12/2020 10:56	2,30	27	62,00	CHI
20201254257	DAMIANOPOLIS	MB12180675	IACIARA S2	10/12/2020 08:38	10/12/2020 16:32	10/12/2020 08:38	10/12/2020 16:32	7,89	8	63,12	CHI
20201254006	LEOPOLDO DE BULHOES	10012969662	DAIA S2	10/12/2020 08:39	10/12/2020 15:13	10/12/2020 08:39	10/12/2020 15:13	6,57	1	6,57	CHI
20201254060	BELA VISTA DE GOIAS	BV12000046	CEPAIGO S2	10/12/2020 08:39	10/12/2020 10:23	10/12/2020 08:39	10/12/2020 10:23	1,72	31	53,26	CHI
20201254027	HIDROLANDIA	HD21291461	CEPAIGO S2	10/12/2020 08:40	10/12/2020 14:55	10/12/2020 08:40	10/12/2020 14:55	6,24	1	6,24	CHI
20201254028	JATAI	JT12080471	JATAI S1	10/12/2020 08:40	11/12/2020 10:55	10/12/2020 08:40	11/12/2020 10:55	26,25	6	157,49	CHI
20201254034	SAO MIGUEL DO ARAGUAIA	SM12342059	SAO MIGUEL DO ARAGUAIA	10/12/2020 08:41	10/12/2020 11:12	10/12/2020 08:41	10/12/2020 11:12	2,51	9	22,61	CHI
20201254038	GOIANIA	GN21001782	REAL S1	10/12/2020 08:41	10/12/2020 11:30	10/12/2020 08:41	10/12/2020 11:30	2,80	1	2,80	CHI
20201254066	PARAUNA	6628789	FIRMINOPOLIS S2	10/12/2020 08:41	10/12/2020 17:53	10/12/2020 08:41	10/12/2020 17:53	9,19	5	45,94	CHI
20201254066	CACHOEIRA DE GOIAS	6628789	FIRMINOPOLIS S2	10/12/2020 08:41	10/12/2020 17:53	10/12/2020 08:41	10/12/2020 17:53	9,19	2	18,38	CHI
20201254043	TURVANIA	TV12289727	FIRMINOPOLIS S2	10/12/2020 08:42	10/12/2020 11:01	10/12/2020 08:42	10/12/2020 11:01	2,31	3	6,92	CHI
20201254089	RIO VERDE	RV21129019	SANTA HELENA S1	10/12/2020 08:42	10/12/2020 10:57	10/12/2020 08:42	10/12/2020 10:57	2,25	1	2,25	CHI
20201254047	LUZIANIA	10018328626	RIO VERMELHO	10/12/2020 08:43	10/12/2020 10:40	10/12/2020 08:43	10/12/2020 10:40	1,95	1	1,95	CHI
20201254052	PIRES DO RIO	PR12328759	PIRES DO RIO S1	10/12/2020 08:43	10/12/2020 09:43	10/12/2020 08:43	10/12/2020 09:43	0,99	1	0,99	CHI
20201254752	GOIATUBA	VI12166490	VICENTINOPOLIS	10/12/2020 08:43	11/12/2020 10:24	10/12/2020 08:43	11/12/2020 10:24	25,68	4	102,71	CHI
20201254752	VICENTINOPOLIS	VI12166490	VICENTINOPOLIS	10/12/2020 08:43	11/12/2020 10:24	10/12/2020 08:43	11/12/2020 10:24	25,68	2	51,36	CHI
20201257301	FORMOSA	FA12255318	ITQUIRA	10/12/2020 08:44	11/12/2020 13:55	10/12/2020 08:44	11/12/2020 13:55	29,18	2	58,35	CHI
20201254069	APORE	AE12219494	ITAJA S1	10/12/2020 08:45	11/12/2020 10:33	10/12/2020 08:45	11/12/2020 10:33	25,80	2	51,60	CHI
20201254115	MINACU	IH12208346	MINACU	10/12/2020 08:45	10/12/2020 21:27	10/12/2020 08:45	10/12/2020 21:27	12,69	12	152,27	CHI
20201254079	QUIRINOPOLIS	QI21306112	QUIRINOPOLIS	10/12/2020 08:46	10/12/2020 21:19	10/12/2020 08:46	10/12/2020 21:19	12,54	1	12,54	CHI
20201254717	PALESTINA DE GOIAS	PY12342606	PALESTINA	10/12/2020 08:46	10/12/2020 15:00	10/12/2020 08:46	10/12/2020 15:00	6,22	6	37,31	CHI
20201254084	CATALAO	CT21192557	CATALAO S1	10/12/2020 08:47	10/12/2020 13:14	10/12/2020 08:47	10/12/2020 13:14	4,45	1	4,45	CHI
20201254107	GOIANIA	13544494	INDEPENDENCIA S2	10/12/2020 08:50	10/12/2020 10:17	10/12/2020 08:50	10/12/2020 10:17	1,44	1	1,44	CHI
20201254109	ITAUCU	IX21277601	INHUMAS S1	10/12/2020 08:50	10/12/2020 11:40	10/12/2020 08:50	10/12/2020 11:40	2,82	2	5,63	CHI
20201254119	JATAI	290052555	JATAI S2	10/12/2020 08:52	10/12/2020 16:57	10/12/2020 08:52	10/12/2020 16:57	8,07	1	8,07	CHI
20201254122	GOIAS	GS12217213	ITABERAI S1	10/12/2020 08:52	10/12/2020 10:41	10/12/2020 08:52	10/12/2020 10:41	1,80	1	1,80	CHI
20201254123	SILVANIA	660033010	VIANOPOLIS	10/12/2020 08:53	10/12/2020 12:06	10/12/2020 08:53	10/12/2020 12:06	3,23	1	3,23	CHI
20201254124	IPAMERI	IP21359965	PIRES DO RIO S2	10/12/2020 08:53	11/12/2020 00:36	10/12/2020 08:53	11/12/2020 00:36	15,71	1	15,71	CHI
20201254125	LUZIANIA	120354056	RIO VERMELHO	10/12/2020 08:53	10/12/2020 10:31	10/12/2020 08:53	10/12/2020 10:31	1,62	1	1,62	CHI
20201254130	PLANALTINA	PB12305257	PADRE BERNARDO	10/12/2020 08:54	10/12/2020 19:33	10/12/2020 08:54	10/12/2020 19:33	10,64	69	734,49	CHI
20201254130	PADRE BERNARDO	PB12305257	PADRE BERNARDO	10/12/2020 08:54	10/12/2020 19:33	10/12/2020 08:54	10/12/2020 19:33	10,64	5	53,22	CHI
20201254134	ITAPURANGA	IK21064439	ITAPURANGA	10/12/2020 08:55	11/12/2020 07:18	10/12/2020 08:55	11/12/2020 07:18	22,38	1	22,38	CHI
20201254142	JARAGUA	JA21099139	JARAGUA	10/12/2020 08:56	10/12/2020 13:26	10/12/2020 08:56	10/12/2020 13:26	4,50	1	4,50	CHI
20201254152	CATALAO	CT12195295	CATALAO S1	10/12/2020 08:56	10/12/2020 16:39	10/12/2020 08:56	10/12/2020 16:39	7,71	3	23,12	CHI
20201255144	JESUPOLIS	SF12021521	SAO FRANCISCO DE GOIAS	10/12/2020 08:56	10/12/2020 18:03	10/12/2020 08:56	10/12/2020 18:03	9,11	5	45,55	CHI
20201255144	SAO FRANCISCO DE GOIAS	SF12021521	SAO FRANCISCO DE GOIAS	10/12/2020 08:56	10/12/2020 18:03	10/12/2020 08:56	10/12/2020 18:03	9,11	2	18,22	CHI
20201254156	INDIARA	IY21312415	CEZARINA	10/12/2020 08:57	10/12/2020 11:01	10/12/2020 08:57	10/12/2020 11:01	2,06	1	2,06	CHI
20201254587	BURITI DE GOIAS	BS12287581	FIRMINOPOLIS S2	10/12/2020 08:57	10/12/2020 12:35	10/12/2020 08:57	10/12/2020 12:35	3,62	11	39,84	CHI
20201254167	CATALAO	CT21000040	CATALAO S1	10/12/2020 08:59	10/12/2020 14:04	10/12/2020 08:59	10/12/2020 14:04	5,08	1	5,08	CHI

20201254171	CABECEIRAS	CW21154403	ITUIQUIRA	10/12/2020 09:00	10/12/2020 11:22	10/12/2020 09:00	10/12/2020 11:22	2,35	1	2,35	CHI
20201256115	POSSE	PS12302648	IACIARA S2	10/12/2020 09:00	10/12/2020 18:49	10/12/2020 09:00	10/12/2020 18:49	9,81	4	39,23	CHI
20201254183	MINEIROS	MY21234033	PARQUE DAS EMAS	10/12/2020 09:02	11/12/2020 09:11	10/12/2020 09:02	11/12/2020 09:11	24,16	1	24,16	CHI
20201254194	ITAPACI	IW21294815	RUBIATABA	10/12/2020 09:03	10/12/2020 18:13	10/12/2020 09:03	10/12/2020 18:13	9,15	1	9,15	CHI
20201254195	PILAR DE GOIAS	NH21247450	SANTA TEREZINHA	10/12/2020 09:03	10/12/2020 17:15	10/12/2020 09:03	10/12/2020 17:15	8,19	1	8,19	CHI
20201254282	JARAGUA	JA12017440	SAO FRANCISCO DE GOIAS	10/12/2020 09:03	10/12/2020 12:34	10/12/2020 09:03	10/12/2020 12:34	3,52	92	323,53	CHI
20201254208	LUZIANIA	3200052336	MARAJOARA	10/12/2020 09:05	10/12/2020 11:32	10/12/2020 09:05	10/12/2020 11:32	2,45	1	2,45	CHI
20201254209	CUMARI	CY21063971	CATALAO S2	10/12/2020 09:05	10/12/2020 10:25	10/12/2020 09:05	10/12/2020 10:25	1,33	1	1,33	CHI
20201254211	SAO JOAO D ALIANCA	JL12261887	SAO JOAO D ALIANCA	10/12/2020 09:05	10/12/2020 11:04	10/12/2020 09:05	10/12/2020 11:04	1,98	3	5,93	CHI
20201254212	ITUMBIARA	10029686375	ITUMBIARA VELHA S1	10/12/2020 09:05	10/12/2020 12:53	10/12/2020 09:05	10/12/2020 12:53	3,79	1	3,79	CHI
20201254213	SANTO ANTONIO DO DESCOBERTO	SN21135451	MARAJOARA	10/12/2020 09:05	10/12/2020 14:01	10/12/2020 09:05	10/12/2020 14:01	4,92	1	4,92	CHI
20201254214	FIRMINOPOLIS	FR21149424	FIRMINOPOLIS S1	10/12/2020 09:05	10/12/2020 11:11	10/12/2020 09:05	10/12/2020 11:11	2,09	1	2,09	CHI
20201254226	SENADOR CANEDO	10009841561	SENADOR CANEDO	10/12/2020 09:07	10/12/2020 12:29	10/12/2020 09:07	10/12/2020 12:29	3,37	1	3,37	CHI
20201254233	BELA VISTA DE GOIAS	BV11000113	CEPAIGO S2	10/12/2020 09:07	10/12/2020 14:08	10/12/2020 09:07	10/12/2020 14:08	5,00	3	15,01	CHI
20201254234	INDIARA	IY21304668	EDEIA	10/12/2020 09:08	10/12/2020 13:48	10/12/2020 09:08	10/12/2020 13:48	4,67	1	4,67	CHI
20201254238	PIRENOPOLIS	PV12227988	CORUMBA	10/12/2020 09:08	10/12/2020 11:35	10/12/2020 09:08	10/12/2020 11:35	2,44	1	2,44	CHI
20201254248	VIANOPOLIS	510041050	VIANOPOLIS	10/12/2020 09:09	10/12/2020 12:49	10/12/2020 09:09	10/12/2020 12:49	3,66	1	3,66	CHI
20201254332	ITARUMA	SX12153265	JATAI S1	10/12/2020 09:09	10/12/2020 19:21	10/12/2020 09:09	10/12/2020 19:21	10,20	1	10,20	CHI
20201254332	APORE	SX12153265	JATAI S1	10/12/2020 09:09	10/12/2020 19:21	10/12/2020 09:09	10/12/2020 19:21	10,20	7	71,37	CHI
20201254332	SERRANOPOLIS	SX12153265	JATAI S1	10/12/2020 09:09	10/12/2020 19:21	10/12/2020 09:09	10/12/2020 19:21	10,20	4	40,79	CHI
20201254250	SANTO ANTONIO DO DESCOBERTO	SN21138196	AGUAS LINDAS DE GOIAS S2	10/12/2020 09:10	10/12/2020 14:43	10/12/2020 09:10	10/12/2020 14:43	5,55	1	5,55	CHI
20201254252	BELA VISTA DE GOIAS	BV21000047	BELA VISTA S1	10/12/2020 09:10	10/12/2020 12:45	10/12/2020 09:10	10/12/2020 12:45	3,58	3	10,74	CHI
20201254255	ITABERAI	IB12250696	ITABERAI S1	10/12/2020 09:10	11/12/2020 14:35	10/12/2020 09:10	10/12/2020 12:10	3,00	5	14,99	CHI
20201254255	ITABERAI	IB12250696	ITABERAI S1	10/12/2020 09:10	11/12/2020 14:35	10/12/2020 09:10	10/12/2020 15:52	6,70	6	40,21	CHI
20201254255	ITABERAI	IB12250696	ITABERAI S1	10/12/2020 09:10	11/12/2020 14:35	10/12/2020 09:10	10/12/2020 17:56	8,77	13	113,96	CHI
20201254255	ITABERAI	IB12250696	ITABERAI S1	10/12/2020 09:10	11/12/2020 14:35	10/12/2020 09:10	11/12/2020 11:07	25,95	9	233,58	CHI
20201254255	ITABERAI	IB12250696	ITABERAI S1	10/12/2020 09:10	11/12/2020 14:35	10/12/2020 09:10	11/12/2020 13:08	27,97	11	307,70	CHI
20201254255	ITABERAI	6706653	ITABERAI S1	10/12/2020 09:10	11/12/2020 14:35	10/12/2020 16:50	11/12/2020 14:34	21,73	2	43,46	CHI
20201254255	ITABERAI	IB12325008	ITABERAI S1	10/12/2020 09:10	11/12/2020 14:35	10/12/2020 16:50	11/12/2020 14:35	21,73	3	65,20	CHI
20201254258	GUARINOS	3720000495	SANTA TEREZINHA	10/12/2020 09:10	10/12/2020 21:09	10/12/2020 09:10	10/12/2020 21:09	11,97	1	11,97	CHI
20201254421	HIDROLINA	UR12048650RE	URUACU	10/12/2020 09:10	10/12/2020 11:00	10/12/2020 09:10	10/12/2020 11:00	1,82	15	27,29	CHI
20201254421	URUACU	UR12048650RE	URUACU	10/12/2020 09:10	10/12/2020 11:00	10/12/2020 09:10	10/12/2020 11:00	1,82	34	61,85	CHI
20201254263	GOIANIA	10004300392	CARAJAS S2	10/12/2020 09:11	10/12/2020 10:43	10/12/2020 09:11	10/12/2020 10:43	1,52	1	1,52	CHI
20201254265	QUIRINOPOLIS	QI12279816	QUIRINOPOLIS	10/12/2020 09:12	11/12/2020 08:33	10/12/2020 09:12	11/12/2020 08:33	23,35	10	233,48	CHI
20201254268	NOVA IGUACU DE GOIAS	NH12243422LD	SANTA TEREZINHA	10/12/2020 09:12	10/12/2020 17:13	10/12/2020 09:12	10/12/2020 17:13	8,02	3	24,07	CHI
20201254268	NOVA IGUACU DE GOIAS	NH12243422LD	SANTA TEREZINHA	10/12/2020 09:12	10/12/2020 17:13	10/12/2020 15:33	10/12/2020 17:13	1,68	32	53,66	CHI
20201254272	GUAPO	GA21000050	GUAPO S2	10/12/2020 09:12	10/12/2020 20:09	10/12/2020 09:12	10/12/2020 20:09	10,93	1	10,93	CHI
20201254273	RIO VERDE	RV21147868	CABRIUVA S1	10/12/2020 09:13	10/12/2020 11:44	10/12/2020 09:13	10/12/2020 11:44	2,52	1	2,52	CHI
20201254287	SANTA RITA DO NOVO DESTINO	DF12382137	BARRO ALTO	10/12/2020 09:13	10/12/2020 16:12	10/12/2020 09:13	10/12/2020 16:12	6,97	12	83,69	CHI
20201256420	MONTE ALEGRE DE GOIAS	MA12218640	SAO DOMINGOS	10/12/2020 09:13	10/12/2020 18:04	10/12/2020 09:13	10/12/2020 18:04	8,84	5	44,21	CHI
20201256420	CAMPOS BELOS	MA12218640	SAO DOMINGOS	10/12/2020 09:13	10/12/2020 18:04	10/12/2020 09:13	10/12/2020 18:04	8,84	2	17,68	CHI
20201254284	MORRINHOS	MR21000230	MORRINHOS	10/12/2020 09:14	10/12/2020 19:08	10/12/2020 09:14	10/12/2020 19:08	9,89	1	9,89	CHI
20201254289	BONOPOLIS	BX12397165	SAO MIGUEL DO ARAGUAIA	10/12/2020 09:15	11/12/2020 09:47	10/12/2020 09:15	11/12/2020 09:47	24,53	4	98,10	CHI
20201254290	DAVINOPOLIS	IO21073885	CATALAO S1	10/12/2020 09:15	10/12/2020 10:31	10/12/2020 09:15	10/12/2020 10:31	1,26	1	1,26	CHI
20201254293	NIQUELANDIA	NQ12213022	NIQUELANDIA SUBTRANSMISSAO	10/12/2020 09:16	10/12/2020 11:19	10/12/2020 09:16	10/12/2020 11:19	2,05	9	18,44	CHI
20201254298	ALEXANIA	480057783	ALEXANIA	10/12/2020 09:16	10/12/2020 12:14	10/12/2020 09:16	10/12/2020 12:14	2,96	1	2,96	CHI
20201254300	ANAPOLIS	20232494	ANAPOLIS UNIVERSITARIO S2	10/12/2020 09:16	10/12/2020 14:51	10/12/2020 09:16	10/12/2020 14:51	5,58	1	5,58	CHI
20201254301	GOIANIA	10544525	ATLANTICO S3	10/12/2020 09:16	10/12/2020 11:16	10/12/2020 09:16	10/12/2020 11:16	1,99	1	1,99	CHI
20201254329	COCALZINHO DE GOIAS	ZN12319615	COCALZINHO	10/12/2020 09:16	10/12/2020 15:59	10/12/2020 09:16	10/12/2020 15:59	6,70	22	147,45	CHI
20201254596	MINACU	IH12241988	MINACU	10/12/2020 09:16	11/12/2020 14:42	10/12/2020 09:16	11/12/2020 14:42	29,42	16	470,69	CHI
20201254304	CATURAI	CK21017184	INHUMAS S1	10/12/2020 09:17	10/12/2020 13:13	10/12/2020 09:17	10/12/2020 13:13	3,93	1	3,93	CHI

20201254464	CATALAO	CT12306664	CATALAO S1	10/12/2020 09:17	10/12/2020 12:22	10/12/2020 09:17	10/12/2020 12:22	3,07	4	12,27	CHI
20201254464	OUVIDOR	CT12306664	CATALAO S1	10/12/2020 09:17	10/12/2020 12:22	10/12/2020 09:17	10/12/2020 12:22	3,07	2	6,14	CHI
20201254310	PORANGATU	PO12240217	MARA ROSA	10/12/2020 09:18	10/12/2020 14:03	10/12/2020 09:18	10/12/2020 14:03	4,74	4	18,98	CHI
20201254312	SANTA TEREZINHA DE GOIAS	2480037788	SANTA TEREZINHA	10/12/2020 09:18	11/12/2020 09:48	10/12/2020 09:18	11/12/2020 09:48	24,49	1	24,49	CHI
20201254313	CRISTALINA	KR21249951	CRISTALINA S2	10/12/2020 09:18	10/12/2020 14:20	10/12/2020 09:18	10/12/2020 14:20	5,02	1	5,02	CHI
20201254318	LUZIANIA	120306268	RIO VERMELHO	10/12/2020 09:20	10/12/2020 11:48	10/12/2020 09:20	10/12/2020 11:48	2,47	1	2,47	CHI
20201254906	POSSE	PS12180840	IACIARA S1	10/12/2020 09:20	10/12/2020 20:18	10/12/2020 09:20	10/12/2020 20:18	10,97	2	21,93	CHI
20201255069	INHUMAS	DL12098268	INHUMAS S1	10/12/2020 09:21	10/12/2020 18:58	10/12/2020 09:21	10/12/2020 18:58	9,62	56	538,81	CHI
20201255069	DAMOLANDIA	DL12098268	INHUMAS S1	10/12/2020 09:21	10/12/2020 18:58	10/12/2020 09:21	10/12/2020 18:58	9,62	6	57,73	CHI
20201254328	PALESTINA DE GOIAS	CP12395428	PALESTINA	10/12/2020 09:23	10/12/2020 12:59	10/12/2020 09:23	10/12/2020 12:59	3,60	5	17,98	CHI
20201255867	ALEXANIA	AX11146816	ALEXANIA	10/12/2020 09:24	10/12/2020 15:35	10/12/2020 09:24	10/12/2020 15:35	6,18	28	173,01	CHI
20201254350	PLANALTINA	PI12324338	SAO JOAO D ALIANCA	10/12/2020 09:27	10/12/2020 11:51	10/12/2020 09:27	10/12/2020 11:51	2,39	6	14,36	CHI
20201254363	FAZENDA NOVA	FN12009681	IPORA	10/12/2020 09:28	10/12/2020 16:08	10/12/2020 09:28	10/12/2020 16:08	6,65	1	6,65	CHI
20201254366	CORUMBA DE GOIAS	CB21291979	ALEXANIA	10/12/2020 09:29	10/12/2020 15:08	10/12/2020 09:29	10/12/2020 15:08	5,64	1	5,64	CHI
20201254369	GUAPO	710027370	GUAPO S1	10/12/2020 09:29	10/12/2020 15:44	10/12/2020 09:29	10/12/2020 15:44	6,23	1	6,23	CHI
20201254511	MARA ROSA	MQ12288582	MARA ROSA	10/12/2020 09:29	10/12/2020 11:44	10/12/2020 09:29	10/12/2020 11:44	2,25	7	15,73	CHI
20201254511	NOVA IGUACU DE GOIAS	MQ12288582	MARA ROSA	10/12/2020 09:29	10/12/2020 11:44	10/12/2020 09:29	10/12/2020 11:44	2,25	1	2,25	CHI
20201254372	MAMBAI	MB12361387	IACIARA S2	10/12/2020 09:30	10/12/2020 16:06	10/12/2020 09:30	10/12/2020 16:06	6,59	2	13,19	CHI
20201254378	OUVIDOR	CT12266109	CATALAO S1	10/12/2020 09:30	10/12/2020 13:59	10/12/2020 09:30	10/12/2020 13:59	4,48	4	17,91	CHI
20201254385	ITABERAI	IB11227035	ITABERAI S1	10/12/2020 09:31	10/12/2020 15:03	10/12/2020 09:31	10/12/2020 15:03	5,53	1	5,53	CHI
20201251750	MINEIROS	MY12166286RE	CHAPADAO DO CEU	10/12/2020 09:32	10/12/2020 12:25	10/12/2020 09:32	10/12/2020 12:25	2,87	6	17,24	CHI
20201251750	SERRANOPOLIS	MY12166286RE	CHAPADAO DO CEU	10/12/2020 09:32	10/12/2020 12:25	10/12/2020 09:32	10/12/2020 12:25	2,87	10	28,73	CHI
20201254608	SILVANIA	SV11011673	DAIA S2	10/12/2020 09:32	10/12/2020 11:43	10/12/2020 09:32	10/12/2020 11:43	2,17	49	106,23	CHI
20201254404	SANTO ANTONIO DA BARRA	BZ21301371	ACREUNA	10/12/2020 09:33	10/12/2020 11:50	10/12/2020 09:33	10/12/2020 11:50	2,28	1	2,28	CHI
20201254408	QUIRINOPOLIS	QI21129241	SANTA HELENA S1	10/12/2020 09:33	11/12/2020 10:49	10/12/2020 09:33	11/12/2020 00:40	15,12	1	15,12	CHI
20201254408	QUIRINOPOLIS	RV12371494	SANTA HELENA S1	10/12/2020 09:33	11/12/2020 10:49	10/12/2020 11:20	11/12/2020 10:49	23,50	14	328,97	CHI
20201254408	RIO VERDE	RV12371494	SANTA HELENA S1	10/12/2020 09:33	11/12/2020 10:49	11/12/2020 00:39	11/12/2020 10:49	10,18	5	50,90	CHI
20201254408	QUIRINOPOLIS	RV12371494	SANTA HELENA S1	10/12/2020 09:33	11/12/2020 10:49	11/12/2020 00:39	11/12/2020 10:49	10,18	23	234,16	CHI
20201254410	INACIOLANDIA	ID21214153	QUIRINOPOLIS	10/12/2020 09:33	10/12/2020 16:19	10/12/2020 09:33	10/12/2020 16:19	6,76	1	6,76	CHI
20201254411	GOIANIA	GN11322419	XAVANTES	10/12/2020 09:33	10/12/2020 11:57	10/12/2020 11:10	10/12/2020 11:57	0,78	90	70,50	CHI
20201254418	CACHOEIRA DE GOIAS	CG21158955	FIRMINOPOLIS S2	10/12/2020 09:34	10/12/2020 12:52	10/12/2020 09:34	10/12/2020 12:52	3,30	1	3,30	CHI
20201254419	IPAMERI	IP21161013	CRISTALINA S2	10/12/2020 09:34	10/12/2020 15:47	10/12/2020 09:34	10/12/2020 15:47	6,21	1	6,21	CHI
20201254431	POSSE	PS12195974RE	IACIARA S2	10/12/2020 09:34	10/12/2020 16:38	10/12/2020 09:34	10/12/2020 16:38	7,06	290	2046,59	CHI
20201254425	CATALAO	CT21165279	CATALAO S1	10/12/2020 09:35	10/12/2020 12:38	10/12/2020 09:35	10/12/2020 12:38	3,04	2	6,08	CHI
20201254426	SANTO ANTONIO DO DESCOBERTO	2210012564	AGUAS LINDAS DE GOIAS S2	10/12/2020 09:35	10/12/2020 10:47	10/12/2020 09:35	10/12/2020 10:47	1,19	1	1,19	CHI
20201254433	TEREZOPOLIS DE GOIAS	TJ21353279	DAIA S2	10/12/2020 09:36	10/12/2020 14:07	10/12/2020 09:36	10/12/2020 14:07	4,50	1	4,50	CHI
20201254439	MINACU	IH12242031	MINACU	10/12/2020 09:37	10/12/2020 14:01	10/12/2020 09:37	10/12/2020 14:01	4,40	3	13,20	CHI
20201254446	SANTA HELENA DE GOIAS	RV21189242	RIO VERDE S2	10/12/2020 09:38	10/12/2020 18:00	10/12/2020 09:38	10/12/2020 18:00	8,36	3	25,07	CHI
20201255331	CACHOEIRA ALTA	PC12209791	CACHOEIRA ALTA	10/12/2020 09:39	10/12/2020 14:44	10/12/2020 09:39	10/12/2020 14:44	5,07	4	20,29	CHI
20201254458	EDEIA	EA21212260	EDEIA	10/12/2020 09:40	10/12/2020 19:17	10/12/2020 09:40	10/12/2020 19:17	9,61	1	9,61	CHI
20201254774	ITAUCU	IX12322432	INHUMAS S1	10/12/2020 09:40	10/12/2020 12:22	10/12/2020 09:40	10/12/2020 12:22	2,69	6	16,14	CHI
20201254472	HIDROLANDIA	10003676330	CEPAIGO S2	10/12/2020 09:41	10/12/2020 15:47	10/12/2020 09:41	10/12/2020 15:47	6,09	1	6,09	CHI
20201254485	CRISTALINA	KR21152357	PAMPLONA	10/12/2020 09:44	10/12/2020 11:51	10/12/2020 09:44	10/12/2020 11:51	2,11	1	2,11	CHI
20201254488	ADELANDIA	DN21152995	FIRMINOPOLIS S2	10/12/2020 09:44	10/12/2020 13:59	10/12/2020 09:44	10/12/2020 13:59	4,24	1	4,24	CHI
20201254496	GOIANIRA	390001168	GOIANIRA	10/12/2020 09:45	10/12/2020 13:16	10/12/2020 09:45	10/12/2020 13:16	3,50	1	3,50	CHI
20201254888	CACU	CC11306355	CACHOEIRA ALTA	10/12/2020 09:45	10/12/2020 12:23	10/12/2020 09:45	10/12/2020 12:23	2,63	59	155,33	CHI
20201254500	CALDAS NOVAS	760185499	CALDAS NOVAS S2	10/12/2020 09:46	10/12/2020 12:59	10/12/2020 09:46	10/12/2020 12:59	3,22	1	3,22	CHI
20201254504	GOIATUBA	GT12318174	BOM JESUS DE GOIAS	10/12/2020 09:47	10/12/2020 19:40	10/12/2020 09:47	10/12/2020 19:40	9,89	2	19,77	CHI
20201254505	NIQUELANDIA	10000948380	BARRO ALTO	10/12/2020 09:48	10/12/2020 11:56	10/12/2020 09:48	10/12/2020 11:56	2,13	1	2,13	CHI
20201254506	NOVA ROMA	ND11272104	IACIARA S2	10/12/2020 09:48	10/12/2020 11:03	10/12/2020 09:48	10/12/2020 11:03	1,25	3	3,75	CHI
20201254512	LEOPOLDO DE BULHOES	10003938784	DAIA S2	10/12/2020 09:48	10/12/2020 18:23	10/12/2020 09:48	10/12/2020 18:23	8,57	1	8,57	CHI

20201254514	NOVA IGUACU DE GOIAS	NH21271745	CAMPINORTE	10/12/2020 09:48	11/12/2020 01:15	10/12/2020 09:48	11/12/2020 01:15	15,43	1	15,43	CHI
20201254515	FAINA	FC12158726	GOIAS	10/12/2020 09:49	10/12/2020 11:53	10/12/2020 09:49	10/12/2020 11:53	2,07	3	6,20	CHI
20201254520	NIQUELANDIA	NQ12358174	URUACU	10/12/2020 09:49	11/12/2020 05:20	10/12/2020 09:49	11/12/2020 05:20	19,50	5	97,51	CHI
20201254541	JUSSARA	JR21363393	BRITANIA	10/12/2020 09:53	10/12/2020 17:04	10/12/2020 09:53	10/12/2020 17:04	7,17	1	7,17	CHI
20201255021	PORANGATU	PO12230401	MARA ROSA	10/12/2020 09:54	11/12/2020 10:29	10/12/2020 09:54	11/12/2020 10:29	24,57	5	122,87	CHI
20201254548	POSSE	PS21262211	IACIARA S2	10/12/2020 09:55	10/12/2020 20:43	10/12/2020 09:55	10/12/2020 20:43	10,80	1	10,80	CHI
20201255230	GOIANDIRA	GD11000003	CATALAO S1	10/12/2020 09:55	10/12/2020 16:43	10/12/2020 09:55	10/12/2020 16:43	6,79	114	774,19	CHI
20201254558	PANAMA	PX12375443	GOIATUBA S1	10/12/2020 09:56	11/12/2020 01:43	10/12/2020 09:56	11/12/2020 01:43	15,78	3	47,35	CHI
20201254561	QUIRINOPOLIS	QI31050386	QUIRINOPOLIS	10/12/2020 09:56	10/12/2020 14:54	10/12/2020 09:56	10/12/2020 14:54	4,95	1	4,95	CHI
20201254562	GOIAS	GS21224030	GOIAS	10/12/2020 09:56	10/12/2020 18:44	10/12/2020 09:56	10/12/2020 18:44	8,79	1	8,79	CHI
20201254770	GOUVELANDIA	GB12261016	QUIRINOPOLIS	10/12/2020 09:56	11/12/2020 02:33	10/12/2020 09:56	11/12/2020 02:33	16,60	5	83,00	CHI
20201254565	MIMOSO DE GOIAS	MJ12339693LD	PADRE BERNARDO	10/12/2020 09:57	10/12/2020 13:06	10/12/2020 09:57	10/12/2020 13:06	3,15	2	6,30	CHI
20201254568	ALTO PARAISO DE GOIAS	3870004767	FLORES DE GOIAS	10/12/2020 09:58	10/12/2020 16:48	10/12/2020 09:58	10/12/2020 16:48	6,83	1	6,83	CHI
20201254569	RIO VERDE	10017264993	RIO VERDE S1	10/12/2020 09:58	10/12/2020 14:35	10/12/2020 09:58	10/12/2020 14:35	4,61	1	4,61	CHI
20201254575	GOIANIA	13218360	REAL S2	10/12/2020 09:58	10/12/2020 11:21	10/12/2020 09:58	10/12/2020 11:21	1,37	1	1,37	CHI
20201254577	GOIANIA	10582885	ATLANTICO S2	10/12/2020 09:59	10/12/2020 11:41	10/12/2020 09:59	10/12/2020 11:41	1,69	1	1,69	CHI
20201254580	PIRENOPOLIS	PV21349377	CORUMBA	10/12/2020 10:00	10/12/2020 20:34	10/12/2020 10:00	10/12/2020 20:34	10,56	3	31,69	CHI
20201254584	CAMPOS VERDES	3790022893	SANTA TEREZINHA	10/12/2020 10:00	10/12/2020 18:34	10/12/2020 10:00	10/12/2020 18:34	8,56	1	8,56	CHI
20201254585	APARECIDA DE GOIANIA	11046843	REAL S2	10/12/2020 10:00	10/12/2020 15:13	10/12/2020 10:00	10/12/2020 15:13	5,21	1	5,21	CHI
20201254589	ADELANDIA	DN21021818	FIRMINOPOLIS S2	10/12/2020 10:01	10/12/2020 14:18	10/12/2020 10:01	10/12/2020 14:18	4,28	2	8,55	CHI
20201254591	EDEIA	EA21305963	RIO DOS BOIS	10/12/2020 10:01	10/12/2020 20:42	10/12/2020 10:01	10/12/2020 20:42	10,67	1	10,67	CHI
20201254595	URUACU	UR12294517LD	URUACU	10/12/2020 10:02	12/12/2020 00:31	10/12/2020 10:02	12/12/2020 00:31	38,48	1	38,48	CHI
20201254595	URUACU	UR12294517LD	URUACU	10/12/2020 10:02	12/12/2020 00:31	10/12/2020 16:35	12/12/2020 00:31	31,94	2	63,89	CHI
20201254974	CRISTALINA	KR12153067	CRISTALINA S2	10/12/2020 10:02	10/12/2020 12:55	10/12/2020 10:02	10/12/2020 12:55	2,88	3	8,64	CHI
20201254597	ALEXANIA	AX21209018	ALEXANIA	10/12/2020 10:03	10/12/2020 11:39	10/12/2020 10:03	10/12/2020 11:39	1,60	1	1,60	CHI
20201255159	JESUPOLIS	JE12377422	SAO FRANCISCO DE GOIAS	10/12/2020 10:03	10/12/2020 15:29	10/12/2020 10:03	10/12/2020 15:29	5,42	6	32,52	CHI
20201256261	CAIAPONIA	XX05679242	MONTIVIDIU T	10/12/2020 10:04	10/12/2020 17:30	10/12/2020 10:04	10/12/2020 17:30	7,43	3	22,28	CHI
20201254618	PLANALTINA	PI21168620	PLANALTINA	10/12/2020 10:05	10/12/2020 13:18	10/12/2020 10:05	10/12/2020 13:18	3,21	1	3,21	CHI
20201254620	SERRANOPOLIS	JT12205191	JATAI S1	10/12/2020 10:05	10/12/2020 20:13	10/12/2020 10:05	10/12/2020 20:13	10,12	2	20,25	CHI
20201254622	HIDROLINA	GG12392056LD	URUACU	10/12/2020 10:05	11/12/2020 13:20	11/12/2020 11:22	11/12/2020 12:10	0,81	5	4,04	CHI
20201254622	PILAR DE GOIAS	GG12392056LD	URUACU	10/12/2020 10:05	11/12/2020 13:20	11/12/2020 11:22	11/12/2020 12:10	0,81	22	17,78	CHI
20201254622	PILAR DE GOIAS	HL21000009	URUACU	10/12/2020 10:05	11/12/2020 13:20	10/12/2020 10:05	11/12/2020 13:20	27,24	1	27,24	CHI
20201255287	RIO VERDE	RV12271417	CABRIUVA S2	10/12/2020 10:05	10/12/2020 13:44	10/12/2020 10:05	10/12/2020 13:44	3,64	6	21,82	CHI
20201254624	CALDAZINHA	LB12029877	DAIA S2	10/12/2020 10:06	10/12/2020 17:15	10/12/2020 10:06	10/12/2020 17:15	7,15	8	57,20	CHI
20201254629	GOIANIA	GN12323266	CEPAIGO S1	10/12/2020 10:06	10/12/2020 13:34	10/12/2020 10:06	10/12/2020 13:34	3,47	78	270,64	CHI
20201254700	ANAPOLIS	AN11351083	ANAPOLIS UNIVERSITARIO S2	10/12/2020 10:06	10/12/2020 11:26	10/12/2020 10:06	10/12/2020 11:26	1,34	35	46,89	CHI
20201255170	CAMPO ALEGRE DE GOIAS	CM12192738RE	CAMPO ALEGRE DE GOIAS	10/12/2020 10:06	10/12/2020 15:30	10/12/2020 10:06	10/12/2020 15:30	5,39	45	242,44	CHI
20201254635	CATALAO	CT12389886	CATALAO S1	10/12/2020 10:08	11/12/2020 13:58	10/12/2020 10:08	11/12/2020 13:58	27,83	3	83,49	CHI
20201254636	FAZENDA NOVA	FN21155361	JUSSARA	10/12/2020 10:08	11/12/2020 10:40	10/12/2020 10:08	11/12/2020 10:40	24,53	1	24,53	CHI
20201254647	CORUMBA DE GOIAS	CB21146621	CORUMBA	10/12/2020 10:09	10/12/2020 16:35	10/12/2020 10:09	10/12/2020 16:35	6,42	1	6,42	CHI
20201254648	PLANALTINA	PI12355794	PLANALTINA	10/12/2020 10:10	10/12/2020 13:50	10/12/2020 10:10	10/12/2020 13:50	3,66	15	54,96	CHI
20201254650	GOIANIA	11184553	GOIANIA LESTE S1	10/12/2020 10:10	10/12/2020 12:25	10/12/2020 10:10	10/12/2020 12:25	2,25	1	2,25	CHI
20201254651	ANAPOLIS	20585263	ANAPOLIS UNIVERSITARIO S1	10/12/2020 10:10	10/12/2020 12:52	10/12/2020 10:10	10/12/2020 12:52	2,70	1	2,70	CHI
20201254656	SERRANOPOLIS	3000013530	JATAI S1	10/12/2020 10:11	10/12/2020 14:24	10/12/2020 10:11	10/12/2020 14:24	4,22	1	4,22	CHI
20201254671	ACREUNA	10027439940	ACREUNA	10/12/2020 10:14	10/12/2020 13:39	10/12/2020 10:14	10/12/2020 13:39	3,41	1	3,41	CHI
20201254672	AMARALINA	LC12230319	NOVA CRIXAS	10/12/2020 10:14	10/12/2020 22:55	10/12/2020 10:14	10/12/2020 22:55	12,67	3	38,01	CHI
20201254678	CALDAS NOVAS	10007967932	CALDAS NOVAS S2	10/12/2020 10:15	10/12/2020 18:11	10/12/2020 10:15	10/12/2020 18:11	7,93	1	7,93	CHI
20201254680	FORMOSA	FA21383294	ITUIQUIRA	10/12/2020 10:15	10/12/2020 12:06	10/12/2020 10:15	10/12/2020 12:06	1,85	1	1,85	CHI
20201255397	ORIZONA	OZ12404726	PIRES DO RIO S1	10/12/2020 10:15	10/12/2020 19:21	10/12/2020 10:15	10/12/2020 19:21	9,10	9	81,87	CHI
20201254686	LUZIANIA	LZ21000516	MARAJOARA	10/12/2020 10:16	10/12/2020 12:08	10/12/2020 10:16	10/12/2020 12:08	1,86	1	1,86	CHI
20201254878	PIRACANJUBA	MR12015135	MORRINHOS	10/12/2020 10:18	10/12/2020 12:08	10/12/2020 10:18	10/12/2020 12:08	1,82	1	1,82	CHI

20201254878	MORRINHOS	MR12015135	MORRINHOS	10/12/2020 10:18	10/12/2020 12:08	10/12/2020 10:18	10/12/2020 12:08	1,82	10	18,22	CHI
20201254715	CAMPESTRE DE GOIAS	GC21024486	TRINDADE	10/12/2020 10:20	10/12/2020 13:40	10/12/2020 10:20	10/12/2020 13:40	3,32	1	3,32	CHI
20201254826	FAINA	FC12220907	GOIAS	10/12/2020 10:21	10/12/2020 16:20	10/12/2020 10:21	10/12/2020 16:20	5,97	12	71,69	CHI
20201255720	PANAMA	PX12057616	GOIATUBA S1	10/12/2020 10:21	10/12/2020 19:19	10/12/2020 10:21	10/12/2020 19:19	8,95	45	402,79	CHI
20201254731	AURILANDIA	AI21161822	FIRMINOPOLIS S2	10/12/2020 10:23	10/12/2020 19:29	10/12/2020 10:23	10/12/2020 19:29	9,08	1	9,08	CHI
20201254733	ITABERAI	10001361595	ITABERAI S2	10/12/2020 10:24	10/12/2020 13:57	10/12/2020 10:24	10/12/2020 13:57	3,55	1	3,55	CHI
20201254735	CALDAS NOVAS	CN121110257	RIO QUENTE	10/12/2020 10:24	10/12/2020 17:24	10/12/2020 10:24	10/12/2020 17:24	7,00	6	41,98	CHI
20201254735	MORRINHOS	CN121110257	RIO QUENTE	10/12/2020 10:24	10/12/2020 17:24	10/12/2020 10:24	10/12/2020 17:24	7,00	7	48,98	CHI
20201254736	ANAPOLIS	10017938633	ANAPOLIS UNIVERSITARIO S2	10/12/2020 10:24	10/12/2020 15:15	10/12/2020 10:24	10/12/2020 15:15	4,84	1	4,84	CHI
20201254747	GOIANIA	11220120	ATLANTICO S2	10/12/2020 10:25	10/12/2020 11:40	10/12/2020 10:25	10/12/2020 11:40	1,24	1	1,24	CHI
20201256385	MORRINHOS	MR12182538	MORRINHOS	10/12/2020 10:25	10/12/2020 17:39	10/12/2020 10:25	10/12/2020 17:39	7,23	4	28,91	CHI
20201254760	PIRACANJUBA	PJ21106644	PIRACANJUBA	10/12/2020 10:26	10/12/2020 13:20	10/12/2020 10:26	10/12/2020 13:20	2,88	1	2,88	CHI
20201254764	FORMOSO	2410015070	PORANGATU	10/12/2020 10:27	10/12/2020 21:22	10/12/2020 10:27	10/12/2020 21:22	10,91	1	10,91	CHI
20201254786	PLANALTINA	2960219783	PLANALTINA	10/12/2020 10:33	10/12/2020 12:06	10/12/2020 10:33	10/12/2020 12:06	1,54	1	1,54	CHI
20201254787	PONTALINA	PK21047365	VICENTINOPOLIS	10/12/2020 10:33	11/12/2020 08:00	10/12/2020 10:33	11/12/2020 08:00	21,44	3	64,31	CHI
20201255422	SAO MIGUEL DO ARAGUAIA	SM12332430	SAO MIGUEL DO ARAGUAIA	10/12/2020 10:33	10/12/2020 16:29	10/12/2020 10:33	10/12/2020 16:29	5,92	35	207,21	CHI
20201254794	ANAPOLIS	AN11346901	JUNDIAI S1	10/12/2020 10:35	10/12/2020 18:34	10/12/2020 10:35	10/12/2020 18:34	7,98	34	271,40	CHI
20201254795	RIO VERDE	RV12020010LD	CABRIUVA S2	10/12/2020 10:35	10/12/2020 14:32	10/12/2020 10:35	10/12/2020 14:32	3,95	50	197,43	CHI
20201254799	TROMBAS	TB21146529	PORANGATU	10/12/2020 10:35	10/12/2020 16:38	10/12/2020 10:35	10/12/2020 16:38	6,04	2	12,08	CHI
20201254800	PIRENOPOLIS	PV21273189	CORUMBA	10/12/2020 10:35	10/12/2020 22:06	10/12/2020 10:35	10/12/2020 22:06	11,51	2	23,01	CHI
20201254801	TROMBAS	TB21281631	PORANGATU	10/12/2020 10:35	10/12/2020 18:57	10/12/2020 10:35	10/12/2020 18:57	8,35	1	8,35	CHI
20201254803	ITUMBIRA	IT21352614	PARANAIBA	10/12/2020 10:35	10/12/2020 11:41	10/12/2020 10:35	10/12/2020 11:41	1,09	1	1,09	CHI
20201254804	JUSSARA	JR12092772	JUSSARA	10/12/2020 10:35	10/12/2020 17:47	10/12/2020 10:35	10/12/2020 17:47	7,19	13	93,41	CHI
20201255081	CALDAS NOVAS	CN11100160	SERRA DE CALDAS	10/12/2020 10:35	10/12/2020 12:10	10/12/2020 10:35	10/12/2020 12:10	1,58	60	94,73	CHI
20201254808	GOIANIA	10020165097	GOIANIA LESTE S2	10/12/2020 10:36	10/12/2020 12:21	10/12/2020 10:36	10/12/2020 12:21	1,74	1	1,74	CHI
20201254816	COCALZINHO DE GOIAS	ZN12273327	AGUAS LINDAS DE GOIAS S2	10/12/2020 10:37	10/12/2020 11:46	10/12/2020 10:37	10/12/2020 11:46	1,14	2	2,28	CHI
20201254841	PIRENOPOLIS	PV12384826	CORUMBA	10/12/2020 10:37	10/12/2020 16:47	10/12/2020 10:37	10/12/2020 16:47	6,16	7	43,11	CHI
20201254820	ARAGOIANIA	10006079367	GUAPO S2	10/12/2020 10:39	10/12/2020 15:30	10/12/2020 10:39	10/12/2020 15:30	4,85	1	4,85	CHI
20201257382	BOM JESUS DE GOIAS	ID12128250	QUIRINOPOLIS	10/12/2020 10:39	11/12/2020 01:48	10/12/2020 10:39	11/12/2020 01:48	15,14	72	1090,24	CHI
20201257382	INACIOLANDIA	ID12128250	QUIRINOPOLIS	10/12/2020 10:39	11/12/2020 01:48	10/12/2020 10:39	11/12/2020 01:48	15,14	9	136,28	CHI
20201254829	GOIANIA	17343112	GOIANIA LESTE S2	10/12/2020 10:42	10/12/2020 12:23	10/12/2020 10:42	10/12/2020 12:23	1,67	1	1,67	CHI
20201254842	PONTALINA	PK32041751	PONTALINA	10/12/2020 10:44	10/12/2020 22:46	10/12/2020 10:44	10/12/2020 22:46	12,03	6	72,18	CHI
20201254842	MAIRIPOTABA	PK32041751	PONTALINA	10/12/2020 10:44	10/12/2020 22:46	10/12/2020 17:49	10/12/2020 22:46	4,94	7	34,60	CHI
20201254842	PONTALINA	PK32041751	PONTALINA	10/12/2020 10:44	10/12/2020 22:46	10/12/2020 17:49	10/12/2020 22:46	4,94	191	944,02	CHI
20201252293	NOVA CRIXAS	NA12091691	NOVA CRIXAS	10/12/2020 10:45	10/12/2020 15:13	10/12/2020 10:45	10/12/2020 15:13	4,46	2	8,93	CHI
20201254857	ABADIANIA	10028815112	ANAPOLIS UNIVERSITARIO S1	10/12/2020 10:46	10/12/2020 21:10	10/12/2020 10:46	10/12/2020 21:10	10,39	1	10,39	CHI
20201256786	CRIXAS	2490036318	SANTA TEREZINHA	10/12/2020 10:46	11/12/2020 15:31	10/12/2020 10:46	11/12/2020 15:31	28,75	1	28,75	CHI
20201254861	GOIANAPOLIS	950012014	DAIA S2	10/12/2020 10:47	10/12/2020 14:02	10/12/2020 10:47	10/12/2020 14:02	3,24	1	3,24	CHI
20201254869	BALIZA	BH11331094	CAIAPONIA	10/12/2020 10:48	11/12/2020 08:45	10/12/2020 10:48	11/12/2020 08:45	21,94	2	43,89	CHI
20201254875	TRINDADE	TR32050470	TRINDADE	10/12/2020 10:48	10/12/2020 19:04	10/12/2020 10:48	10/12/2020 19:04	8,26	6	49,58	CHI
20201254876	LUZIANIA	LZ21282127	RIO VERMELHO	10/12/2020 10:49	10/12/2020 14:19	10/12/2020 10:49	10/12/2020 14:19	3,50	2	7,00	CHI
20201254879	SANCLERLANDIA	1210006483	FIRMINOPOLIS S2	10/12/2020 10:49	10/12/2020 14:36	10/12/2020 10:49	10/12/2020 14:36	3,77	1	3,77	CHI
20201255551	SANTA CRUZ DE GOIAS	BC12311715	PIRES DO RIO S2	10/12/2020 10:55	10/12/2020 17:22	10/12/2020 10:55	10/12/2020 17:22	6,45	8	51,57	CHI
20201254907	PLANALTINA	PI21109470	PLANALTINA	10/12/2020 10:56	10/12/2020 12:26	10/12/2020 10:56	10/12/2020 12:26	1,50	2	2,99	CHI
20201254911	NOVO GAMA	2460018168	PACAEMBU S1	10/12/2020 10:56	10/12/2020 13:56	10/12/2020 10:56	10/12/2020 13:56	2,98	1	2,98	CHI
20201254946	SAO JOAO D ALIANCA	JL12383335	SAO JOAO D ALIANCA	10/12/2020 10:59	10/12/2020 15:54	10/12/2020 10:59	10/12/2020 15:54	4,91	11	54,02	CHI
20201255085	IVOLANDIA	IV12249611	IPORA	10/12/2020 10:59	10/12/2020 14:53	10/12/2020 10:59	10/12/2020 14:53	3,89	6	23,32	CHI
20201255085	CAIAPONIA	IV12249611	IPORA	10/12/2020 10:59	10/12/2020 14:53	10/12/2020 10:59	10/12/2020 14:53	3,89	2	7,77	CHI
20201254932	GOIANIA	16307707	CARAJAS S1	10/12/2020 11:01	10/12/2020 13:40	10/12/2020 11:01	10/12/2020 13:40	2,65	1	2,65	CHI
20201254941	NIQUELANDIA	6709892	BARRO ALTO	10/12/2020 11:01	10/12/2020 11:35	10/12/2020 11:01	10/12/2020 11:35	0,55	1	0,55	CHI
20201254947	NOVO BRASIL	NB12020227	JUSSARA	10/12/2020 11:03	11/12/2020 19:07	10/12/2020 11:03	11/12/2020 17:12	30,16	7	211,09	CHI

20201254947	NOVO BRASIL	NB12020227	JUSSARA	10/12/2020 11:03	11/12/2020 19:07	10/12/2020 11:03	11/12/2020 18:27	31,41	4	125,64	CHI
20201254947	FAZENDA NOVA	NB12020227	JUSSARA	10/12/2020 11:03	11/12/2020 19:07	10/12/2020 11:03	11/12/2020 19:07	32,08	1	32,08	CHI
20201254947	NOVO BRASIL	NB12020227	JUSSARA	10/12/2020 11:03	11/12/2020 19:07	10/12/2020 11:03	11/12/2020 19:07	32,08	4	128,31	CHI
20201254949	GOIANIA	10852219	GOIANIA LESTE S1	10/12/2020 11:03	10/12/2020 15:46	10/12/2020 11:03	10/12/2020 15:46	4,71	1	4,71	CHI
20201254950	UIRAPURU	UP21373466	SANTA TEREZINHA	10/12/2020 11:03	11/12/2020 09:56	10/12/2020 11:03	11/12/2020 09:56	22,87	1	22,87	CHI
20201254952	BRITANIA	BT21188090	BRITANIA	10/12/2020 11:04	10/12/2020 19:53	10/12/2020 11:04	10/12/2020 19:53	8,83	1	8,83	CHI
20201254953	FLORES DE GOIAS	AQ21278109	IACIARA S2	10/12/2020 11:04	10/12/2020 17:54	10/12/2020 11:04	10/12/2020 17:54	6,83	1	6,83	CHI
20201254958	MONTE ALEGRE DE GOIAS	MA11273518	SAO DOMINGOS	10/12/2020 11:04	10/12/2020 12:49	10/12/2020 11:04	10/12/2020 12:49	1,74	1	1,74	CHI
20201255138	CORUMBA DE GOIAS	CB12089152	COCALZINHO	10/12/2020 11:04	10/12/2020 14:50	10/12/2020 11:04	10/12/2020 14:50	3,76	6	22,53	CHI
20201254983	CRISTIANOPOLIS	CF13409097B	CRISTIANOPOLIS	10/12/2020 11:05	10/12/2020 13:02	10/12/2020 11:05	10/12/2020 13:02	1,96	104	203,93	CHI
20201254983	PIRACANJUBA	CF13409097B	CRISTIANOPOLIS	10/12/2020 11:05	10/12/2020 13:02	10/12/2020 11:05	10/12/2020 13:02	1,96	163	319,62	CHI
20201259672	ITUMBIARA	10003559031	ITUMBIARA VELHA S2	10/12/2020 11:08	11/12/2020 11:16	10/12/2020 11:08	11/12/2020 11:16	24,12	1	24,12	CHI
20201254984	NIQUELANDIA	NQ21330294	NIQUELANDIA SUBTRANSMISSAO	10/12/2020 11:10	10/12/2020 17:15	10/12/2020 11:10	10/12/2020 17:15	6,09	1	6,09	CHI
20201254987	CORUMBAIBA	CI21424354	VILA CORUMBA	10/12/2020 11:10	10/12/2020 19:13	10/12/2020 11:10	10/12/2020 19:13	8,05	1	8,05	CHI
20201254990	MONTIVIDIU	MV12147843	MONTIVIDIU T	10/12/2020 11:10	11/12/2020 09:12	10/12/2020 11:10	11/12/2020 09:12	22,02	4	88,07	CHI
20201256957	ABADIANIA	AA11043862	ANAPOLIS UNIVERSITARIO S1	10/12/2020 11:10	10/12/2020 17:03	10/12/2020 11:10	10/12/2020 17:03	5,87	87	511,05	CHI
20201257593	SERRANOPOLIS	SX12166009	JATAI S1	10/12/2020 11:10	11/12/2020 08:25	10/12/2020 11:10	11/12/2020 08:25	21,25	9	191,24	CHI
20201254997	NOVA IGUAÇU DE GOIAS	NH12374720	URUACU	10/12/2020 11:11	10/12/2020 17:34	10/12/2020 11:11	10/12/2020 17:34	6,37	7	44,58	CHI
20201254998	SAO MIGUEL DO PASSA QUATRO	SQ31096190	BELA VISTA S2	10/12/2020 11:11	10/12/2020 14:46	10/12/2020 11:11	10/12/2020 14:46	3,57	1	3,57	CHI
20201255010	LEOPOLDO DE BULHOES	LB12351258	DAIA S2	10/12/2020 11:11	10/12/2020 12:43	10/12/2020 11:11	10/12/2020 12:43	1,52	9	13,67	CHI
20201255000	NOVA AURORA	CI21076952	CATALAO S1	10/12/2020 11:12	10/12/2020 15:43	10/12/2020 11:12	10/12/2020 15:43	4,51	1	4,51	CHI
20201256235	CRISTALINA	KR12250016	PAMPLONA	10/12/2020 11:12	10/12/2020 18:10	10/12/2020 11:12	10/12/2020 18:10	6,96	27	188,04	CHI
20201255005	VALPARAISO DE GOIAS	VA11183570	PACAEMBU S1	10/12/2020 11:13	10/12/2020 12:55	10/12/2020 11:13	10/12/2020 12:55	1,70	137	232,41	CHI
20201255016	URUACU	640066537	URUACU	10/12/2020 11:15	10/12/2020 13:25	10/12/2020 11:15	10/12/2020 13:25	2,16	1	2,16	CHI
20201255105	RIO QUENTE	RQ12392082	VILA CORUMBA	10/12/2020 11:15	10/12/2020 16:07	10/12/2020 11:15	10/12/2020 16:07	4,85	17	82,48	CHI
20201255212	LUZIANIA	LZ12033418	RIO VERMELHO	10/12/2020 11:15	11/12/2020 14:42	10/12/2020 11:15	11/12/2020 14:42	27,45	20	549,07	CHI
20201255332	RUBIATABA	RB12062073	RUBIATABA	10/12/2020 11:15	10/12/2020 23:33	10/12/2020 11:15	10/12/2020 23:33	12,28	2	24,57	CHI
20201256234	GAMELEIRA DE GOIAS	SV12125444	DAIA S2	10/12/2020 11:15	11/12/2020 08:27	10/12/2020 11:15	11/12/2020 08:27	21,18	29	614,36	CHI
20201255025	CRISTALINA	KR21244574	CRISTALINA S1	10/12/2020 11:16	10/12/2020 15:52	10/12/2020 11:16	10/12/2020 15:52	4,59	1	4,59	CHI
20201255035	PADRE BERNARDO	PB12376784	PADRE BERNARDO	10/12/2020 11:18	10/12/2020 12:01	10/12/2020 11:18	10/12/2020 12:01	0,70	231	161,96	CHI
20201255038	CRISTALINA	KR12270342	CRISTALINA S2	10/12/2020 11:19	10/12/2020 15:11	10/12/2020 11:19	10/12/2020 15:11	3,85	1	3,85	CHI
20201255042	RIO VERDE	630528883	RIO VERDE S2	10/12/2020 11:20	10/12/2020 14:43	10/12/2020 11:20	10/12/2020 14:43	3,37	1	3,37	CHI
20201255058	SAO FRANCISCO DE GOIAS	SF12080076	SAO FRANCISCO DE GOIAS	10/12/2020 11:20	10/12/2020 15:55	10/12/2020 11:20	10/12/2020 15:55	4,57	18	82,25	CHI
20201255048	MARZAGAO	MG21246556	VILA CORUMBA	10/12/2020 11:21	10/12/2020 17:15	10/12/2020 11:21	10/12/2020 17:15	5,89	1	5,89	CHI
20201255050	CHAPADAO DO CEU	10000880106	CHAPADAO DO CEU	10/12/2020 11:21	10/12/2020 21:51	10/12/2020 11:21	10/12/2020 21:51	10,49	1	10,49	CHI
20201255052	RIO VERDE	630521098	RIO VERDE S2	10/12/2020 11:22	10/12/2020 19:40	10/12/2020 11:22	10/12/2020 19:40	8,29	1	8,29	CHI
20201255054	HIDROLANDIA	HD31142544	ROCHEDO	10/12/2020 11:23	10/12/2020 20:17	10/12/2020 11:23	10/12/2020 20:17	8,90	1	8,90	CHI
20201255055	PIRACANJUBA	PJ21097878	BELA VISTA S1	10/12/2020 11:23	10/12/2020 14:19	10/12/2020 11:23	10/12/2020 14:19	2,93	1	2,93	CHI
20201256461	GOIATUBA	GT12247742	BOM JESUS DE GOIAS	10/12/2020 11:23	10/12/2020 19:34	10/12/2020 11:23	10/12/2020 19:34	8,18	7	57,27	CHI
20201255068	ANAPOLIS	10018676934	ANAPOLIS UNIVERSITARIO S2	10/12/2020 11:26	10/12/2020 19:14	10/12/2020 11:26	10/12/2020 19:14	7,81	1	7,81	CHI
20201255107	SILVANIA	SV12078642	VIANOPOLIS	10/12/2020 11:26	10/12/2020 15:53	10/12/2020 11:26	10/12/2020 15:53	4,44	15	66,63	CHI
20201255075	FORMOSA	FA12383234	ITIQUEIRA	10/12/2020 11:27	11/12/2020 17:57	10/12/2020 11:27	11/12/2020 17:57	30,51	15	457,61	CHI
20201255083	SAO JOAO D ALIANCA	JL12144660	SAO JOAO D ALIANCA	10/12/2020 11:28	10/12/2020 13:14	10/12/2020 11:28	10/12/2020 13:14	1,75	2	3,50	CHI
20201255084	NOVA CRIXAS	10017414847	NOVA CRIXAS	10/12/2020 11:28	11/12/2020 14:21	10/12/2020 11:28	11/12/2020 14:21	26,87	1	26,87	CHI
20201255330	MUTUNOPOLIS	MU12354546	MARA ROSA	10/12/2020 11:28	10/12/2020 14:27	10/12/2020 11:28	10/12/2020 14:27	2,98	6	17,89	CHI
20201255088	IPAMERI	IP11107625	IPAMERI	10/12/2020 11:31	10/12/2020 18:03	10/12/2020 11:31	10/12/2020 18:03	6,52	47	306,35	CHI
20201255091	FORMOSA	FA12361428	SAO JOAO D ALIANCA	10/12/2020 11:31	12/12/2020 09:19	10/12/2020 11:31	12/12/2020 09:19	45,79	2	91,58	CHI
20201255093	JATAI	290103307	JATAI S2	10/12/2020 11:31	10/12/2020 15:41	10/12/2020 11:31	10/12/2020 15:41	4,15	1	4,15	CHI
20201255095	CATALAO	1990105480	CATALAO S2	10/12/2020 11:31	10/12/2020 14:36	10/12/2020 11:31	10/12/2020 14:36	3,07	1	3,07	CHI
20201255119	CORREGO DO OURO	1070006420	FIRMINOPOLIS S2	10/12/2020 11:31	10/12/2020 14:16	10/12/2020 11:31	10/12/2020 14:16	2,74	1	2,74	CHI
20201255099	APARECIDA DE GOIANIA	10009513769	REAL S1	10/12/2020 11:32	10/12/2020 12:17	10/12/2020 11:32	10/12/2020 12:17	0,73	1	0,73	CHI

20201255109	ITABERAÍ	10011220781	ITABERAÍ S2	10/12/2020 11:35	10/12/2020 12:45	10/12/2020 11:35	10/12/2020 12:45	1,16	1	1,16	CHI
20201255112	LUZIANA	LZ11029344	RIO VERMELHO	10/12/2020 11:36	10/12/2020 13:00	10/12/2020 11:36	10/12/2020 13:00	1,39	99	137,56	CHI
20201255340	PETROLINA DE GOIAS	03040214	INHUMAS S1	10/12/2020 11:36	10/12/2020 15:24	10/12/2020 11:36	10/12/2020 15:24	3,79	106	402,18	CHI
20201255340	SANTA ROSA DE GOIAS	03040214	INHUMAS S1	10/12/2020 11:36	10/12/2020 15:24	10/12/2020 11:36	10/12/2020 15:24	3,79	479	1817,41	CHI
20201255340	ITAUCU	03040214	INHUMAS S1	10/12/2020 11:36	10/12/2020 15:24	10/12/2020 11:36	10/12/2020 15:24	3,79	6	22,77	CHI
20201255115	APARECIDA DE GOIANIA	200037092	INDEPENDENCIA S2	10/12/2020 11:37	10/12/2020 15:25	10/12/2020 11:37	10/12/2020 15:25	3,80	1	3,80	CHI
20201255116	MATRINCHA	MP12299744	MATRINCHA	10/12/2020 11:37	11/12/2020 02:39	10/12/2020 11:37	11/12/2020 02:39	15,03	2	30,06	CHI
20201255124	SANTO ANTONIO DO DESCOBERTO	SN21313997	MARAJÓARA	10/12/2020 11:38	10/12/2020 12:16	10/12/2020 11:38	10/12/2020 12:16	0,63	2	1,26	CHI
20201255137	PORANGATU	PO21139133	NOVO PLANALTO	10/12/2020 11:39	10/12/2020 12:37	10/12/2020 11:39	10/12/2020 12:37	0,95	1	0,95	CHI
20201255184	ITAUCU	IX12013157	INHUMAS S2	10/12/2020 11:39	11/12/2020 04:25	10/12/2020 11:39	11/12/2020 04:25	16,76	5	83,81	CHI
20201255184	SANTA ROSA DE GOIAS	IX12013157	INHUMAS S2	10/12/2020 11:39	11/12/2020 04:25	10/12/2020 11:39	11/12/2020 04:25	16,76	11	184,39	CHI
20201255140	SAO MIGUEL DO PASSA QUATRO	SQ21111748	CRISTIANOPOLIS	10/12/2020 11:40	10/12/2020 16:41	10/12/2020 11:40	10/12/2020 16:41	5,01	1	5,01	CHI
20201255141	ANAPOLIS	21217518	ANAPOLIS UNIVERSITARIO S2	10/12/2020 11:40	10/12/2020 18:10	10/12/2020 11:40	10/12/2020 18:10	6,49	1	6,49	CHI
20201255147	LUZIANA	LZ21304722	MARAJÓARA	10/12/2020 11:42	10/12/2020 17:52	10/12/2020 11:42	10/12/2020 17:52	6,18	1	6,18	CHI
20201255157	VICENTINOPOLIS	VI21346921	VICENTINOPOLIS	10/12/2020 11:43	11/12/2020 12:38	10/12/2020 11:43	11/12/2020 12:38	24,90	6	149,42	CHI
20201255164	GOIANIA	14541622	CAMPINAS S2	10/12/2020 11:45	10/12/2020 14:16	10/12/2020 11:45	10/12/2020 14:16	2,52	1	2,52	CHI
20201255165	ITAPIRAPUA	IU21198752	MATRINCHA	10/12/2020 11:45	10/12/2020 16:55	10/12/2020 11:45	10/12/2020 16:55	5,16	2	10,32	CHI
20201255173	SAO MIGUEL DO ARAGUAIA	SM12390369	SAO MIGUEL DO ARAGUAIA	10/12/2020 11:46	11/12/2020 10:40	10/12/2020 11:46	11/12/2020 10:40	22,90	1	22,90	CHI
20201255176	ANAPOLIS	21163376	ANAPOLIS UNIVERSITARIO S2	10/12/2020 11:46	10/12/2020 20:28	10/12/2020 11:46	10/12/2020 20:28	8,69	1	8,69	CHI
20201255177	NIQUELANDIA	NQ12265966	NIQUELANDIA SUBTRANSMISSAO	10/12/2020 11:46	10/12/2020 18:58	10/12/2020 11:46	10/12/2020 16:04	4,29	15	64,39	CHI
20201255177	NIQUELANDIA	NQ12265966	NIQUELANDIA SUBTRANSMISSAO	10/12/2020 11:46	10/12/2020 18:58	10/12/2020 11:46	10/12/2020 18:58	7,19	10	71,92	CHI
20201255193	GOIAS	IK21087734	GOIAS	10/12/2020 11:48	10/12/2020 15:03	10/12/2020 11:48	10/12/2020 15:03	3,24	1	3,24	CHI
20201255716	NIQUELANDIA	NQ12197539	NIQUELANDIA SUBTRANSMISSAO	10/12/2020 11:48	11/12/2020 14:13	10/12/2020 11:48	11/12/2020 14:13	26,41	15	396,20	CHI
20201255250	VALPARAISO DE GOIAS	VA11261559	PACAEMBU S2	10/12/2020 11:50	10/12/2020 13:56	10/12/2020 11:50	10/12/2020 13:56	2,09	329	686,51	CHI
20201255201	PIRACANJUBA	PJ21040790	PIRACANJUBA	10/12/2020 11:51	10/12/2020 14:27	10/12/2020 11:51	10/12/2020 14:27	2,59	1	2,59	CHI
20201255203	RIO VERDE	RV21155855	SANTA HELENA S1	10/12/2020 11:52	10/12/2020 14:26	10/12/2020 11:52	10/12/2020 14:26	2,56	1	2,56	CHI
20201255207	DOVERLANDIA	10021115263	CAIAPONIA	10/12/2020 11:52	11/12/2020 09:16	10/12/2020 11:52	11/12/2020 09:16	21,40	1	21,40	CHI
20201255208	CRISTALINA	KR12219766	PAMPLONA	10/12/2020 11:52	10/12/2020 15:22	10/12/2020 11:52	10/12/2020 15:22	3,49	3	10,48	CHI
20201255210	INACIOLANDIA	ID21128179	QUIRINOPOLIS	10/12/2020 11:52	10/12/2020 17:21	10/12/2020 11:52	10/12/2020 17:21	5,47	1	5,47	CHI
20201255357	INHUMAS	GR12033390	GOIANIRA	10/12/2020 11:53	10/12/2020 15:23	10/12/2020 11:53	10/12/2020 15:23	3,50	9	31,46	CHI
20201255357	CATURAI	GR12033390	GOIANIRA	10/12/2020 11:53	10/12/2020 15:23	10/12/2020 11:53	10/12/2020 15:23	3,50	160	559,29	CHI
20201255357	GOIANIRA	GR12033390	GOIANIRA	10/12/2020 11:53	10/12/2020 15:23	10/12/2020 11:53	10/12/2020 15:23	3,50	19	66,42	CHI
20201255215	CACU	10008247275	CACHOEIRA ALTA	10/12/2020 11:54	10/12/2020 16:44	10/12/2020 11:54	10/12/2020 16:44	4,83	1	4,83	CHI
20201255219	NOVA VENEZA	NR21277035	INHUMAS S1	10/12/2020 11:54	10/12/2020 22:16	10/12/2020 11:54	10/12/2020 22:16	10,35	2	20,70	CHI
20201256187	MINEIROS	MY12197099	PARQUE DAS EMAS	10/12/2020 11:54	10/12/2020 23:40	10/12/2020 11:54	10/12/2020 23:40	11,75	9	105,76	CHI
20201255227	TEREZOPOLIS DE GOIAS	TJ21212672	JUNDIAI S2	10/12/2020 11:55	10/12/2020 21:00	10/12/2020 11:55	10/12/2020 21:00	9,07	1	9,07	CHI
20201255742	MONTES CLAROS DE GOIAS	ME12334949	IPORA	10/12/2020 11:56	10/12/2020 17:04	10/12/2020 11:56	10/12/2020 17:04	5,12	7	35,87	CHI
20201255242	ALEXANIA	AX21128913	ALEXANIA	10/12/2020 11:57	10/12/2020 21:10	10/12/2020 11:57	10/12/2020 21:10	9,20	1	9,20	CHI
20201255248	QUIRINOPOLIS	QI21296667	QUIRINOPOLIS	10/12/2020 11:58	11/12/2020 09:20	10/12/2020 11:58	11/12/2020 09:20	21,36	1	21,36	CHI
20201255249	JATAI	JT21361511	JATAI S1	10/12/2020 11:58	10/12/2020 14:06	10/12/2020 11:58	10/12/2020 14:06	2,12	1	2,12	CHI
20201257669	GOIAS	GS12021596	GOIAS	10/12/2020 11:58	11/12/2020 10:15	10/12/2020 11:58	11/12/2020 10:15	22,29	5	111,47	CHI
20201255254	JANDAIA	1180021189	PALMEIRAS	10/12/2020 11:59	10/12/2020 14:05	10/12/2020 11:59	10/12/2020 14:05	2,09	1	2,09	CHI
20201255255	ORIZONA	2060000021	PIRES DO RIO S2	10/12/2020 11:59	10/12/2020 15:30	10/12/2020 11:59	10/12/2020 15:30	3,50	1	3,50	CHI
20201255256	SENADOR CANEDO	SW12362879	SENADOR CANEDO	10/12/2020 12:00	10/12/2020 13:18	10/12/2020 12:00	10/12/2020 13:18	1,30	154	200,20	CHI
20201256269	CAMPOS VERDES	SG12318464	SANTA TEREZINHA	10/12/2020 12:00	11/12/2020 10:11	10/12/2020 12:00	11/12/2020 10:11	22,17	13	288,23	CHI
20201256269	SANTA TEREZINHA DE GOIAS	SG12318464	SANTA TEREZINHA	10/12/2020 12:00	11/12/2020 10:11	10/12/2020 12:00	11/12/2020 10:11	22,17	32	709,49	CHI
20201256269	UIRAPURU	SG12318464	SANTA TEREZINHA	10/12/2020 12:00	11/12/2020 10:11	10/12/2020 12:00	11/12/2020 10:11	22,17	13	288,23	CHI
20201255263	TRINDADE	TR11385492	TRINDADE	10/12/2020 12:02	10/12/2020 16:27	10/12/2020 12:02	10/12/2020 16:27	4,41	44	193,95	CHI
20201255266	VALPARAISO DE GOIAS	VA21067381	PACAEMBU S1	10/12/2020 12:03	10/12/2020 14:06	10/12/2020 12:03	10/12/2020 14:06	2,05	1	2,05	CHI
20201255272	TRINDADE	10009294226	TRINDADE	10/12/2020 12:04	10/12/2020 14:04	10/12/2020 12:04	10/12/2020 14:04	2,00	1	2,00	CHI
20201255281	CACHOEIRA ALTA	1090011201	CACHOEIRA ALTA	10/12/2020 12:06	10/12/2020 16:14	10/12/2020 12:06	10/12/2020 16:14	4,13	1	4,13	CHI

20201255282	CIDADE OCIDENTAL	20454321	RIO VERMELHO	10/12/2020 12:06	10/12/2020 17:47	10/12/2020 12:06	10/12/2020 17:47	5,67	3	17,00	CHI
20201255982	MINEIROS	SU12248425	SANTA RITA DO ARAGUAIA	10/12/2020 12:07	10/12/2020 20:18	10/12/2020 12:07	10/12/2020 20:18	8,18	9	73,62	CHI
20201255982	BURITINOPOLIS	SU12248425	SANTA RITA DO ARAGUAIA	10/12/2020 12:07	10/12/2020 20:18	10/12/2020 12:07	10/12/2020 20:18	8,18	1	8,18	CHI
20201255982	SANTA RITA DO ARAGUAIA	SU12248425	SANTA RITA DO ARAGUAIA	10/12/2020 12:07	10/12/2020 20:18	10/12/2020 12:07	10/12/2020 20:18	8,18	136	1112,44	CHI
20201255348	MINEIROS	PW10341001	PARQUE DAS EMAS	10/12/2020 12:08	12/12/2020 18:51	10/12/2020 17:35	10/12/2020 17:53	0,30	198	58,74	CHI
20201255348	DOVERLANDIA	PW10341001	PARQUE DAS EMAS	10/12/2020 12:08	12/12/2020 18:51	10/12/2020 17:35	10/12/2020 17:53	0,30	66	19,58	CHI
20201255348	PORTELANDIA	PW10341001	PARQUE DAS EMAS	10/12/2020 12:08	12/12/2020 18:51	10/12/2020 17:35	10/12/2020 17:53	0,30	152	45,09	CHI
20201255348	PORTELANDIA	PW10341001	PARQUE DAS EMAS	10/12/2020 12:08	12/12/2020 18:51	10/12/2020 17:57	10/12/2020 22:02	4,07	105	427,35	CHI
20201255348	MINEIROS	PW10341001	PARQUE DAS EMAS	10/12/2020 12:08	12/12/2020 18:51	10/12/2020 17:57	10/12/2020 22:02	4,07	7	28,49	CHI
20201255348	DOVERLANDIA	PW13147990	PARQUE DAS EMAS	10/12/2020 12:08	12/12/2020 18:51	10/12/2020 17:57	11/12/2020 12:34	18,61	66	1228,39	CHI
20201255348	PORTELANDIA	PW13147990	PARQUE DAS EMAS	10/12/2020 12:08	12/12/2020 18:51	10/12/2020 17:57	11/12/2020 12:34	18,61	47	874,76	CHI
20201255348	MINEIROS	PW13147990	PARQUE DAS EMAS	10/12/2020 12:08	12/12/2020 18:51	10/12/2020 17:57	11/12/2020 12:34	18,61	191	3554,88	CHI
20201255348	MINEIROS	MY10402689	PARQUE DAS EMAS	10/12/2020 12:08	12/12/2020 18:51	11/12/2020 12:43	11/12/2020 12:59	0,26	20	5,26	CHI
20201255348	MINEIROS	PW10408096	PARQUE DAS EMAS	10/12/2020 12:08	12/12/2020 18:51	10/12/2020 12:08	11/12/2020 13:02	24,91	43	1071,00	CHI
20201255348	DOVERLANDIA	MY12210052LD	PARQUE DAS EMAS	10/12/2020 12:08	12/12/2020 18:51	11/12/2020 12:43	11/12/2020 13:12	0,49	66	32,01	CHI
20201255348	MINEIROS	MY12210052LD	PARQUE DAS EMAS	10/12/2020 12:08	12/12/2020 18:51	11/12/2020 12:43	11/12/2020 13:12	0,49	37	17,95	CHI
20201255348	MINEIROS	PW10408096	PARQUE DAS EMAS	10/12/2020 12:08	12/12/2020 18:51	11/12/2020 18:56	11/12/2020 19:27	0,52	43	22,20	CHI
20201255348	MINEIROS	PW10408096	PARQUE DAS EMAS	10/12/2020 12:08	12/12/2020 18:51	11/12/2020 19:44	11/12/2020 20:13	0,47	43	20,34	CHI
20201255348	MINEIROS	MY13305762	PARQUE DAS EMAS	10/12/2020 12:08	12/12/2020 18:51	10/12/2020 12:08	11/12/2020 23:17	35,15	14	492,12	CHI
20201255348	MINEIROS	PW10408096	PARQUE DAS EMAS	10/12/2020 12:08	12/12/2020 18:51	12/12/2020 10:20	12/12/2020 13:01	2,68	57	152,85	CHI
20201255348	MINEIROS	MY13305762	PARQUE DAS EMAS	10/12/2020 12:08	12/12/2020 18:51	10/12/2020 12:08	12/12/2020 18:31	54,39	7	380,72	CHI
20201255348	SANTA RITA DO ARAGUAIA	MY13142228	PARQUE DAS EMAS	10/12/2020 12:08	12/12/2020 18:51	10/12/2020 12:08	12/12/2020 18:51	54,73	4	218,90	CHI
20201255348	MINEIROS	MY13142228	PARQUE DAS EMAS	10/12/2020 12:08	12/12/2020 18:51	10/12/2020 12:08	12/12/2020 18:51	54,73	107	5855,69	CHI
20201255465	LUZIANIA	LZ11163904	RIO VERMELHO	10/12/2020 12:08	10/12/2020 14:53	10/12/2020 12:08	10/12/2020 14:53	2,74	150	410,87	CHI
20201255292	TURVELANDIA	TD21040337	RIO DOS BOIS	10/12/2020 12:09	10/12/2020 22:39	10/12/2020 12:09	10/12/2020 22:39	10,48	1	10,48	CHI
20201257100	SERRANOPOLIS	SX12260467	JATAI S1	10/12/2020 12:09	10/12/2020 21:21	10/12/2020 12:09	10/12/2020 21:21	9,19	8	73,54	CHI
20201256676	ANAPOLIS	AN11090384	ANAPOLIS UNIVERSITARIO S1	10/12/2020 12:10	11/12/2020 09:41	10/12/2020 12:10	11/12/2020 09:41	21,52	101	2173,07	CHI
20201255301	MINEIROS	MY21308763	PARQUE DAS EMAS	10/12/2020 12:11	11/12/2020 13:04	10/12/2020 12:11	11/12/2020 13:04	24,88	1	24,88	CHI
20201255303	INHUMAS	IN11013793	INHUMAS S2	10/12/2020 12:11	10/12/2020 16:14	10/12/2020 12:11	10/12/2020 16:14	4,05	69	279,22	CHI
20201255307	LUZIANIA	3200169070	RIO VERMELHO	10/12/2020 12:11	10/12/2020 13:15	10/12/2020 12:11	10/12/2020 13:15	1,06	1	1,06	CHI
20201255310	ANAPOLIS	10002530196	JUNDIAI S1	10/12/2020 12:12	10/12/2020 20:07	10/12/2020 12:12	10/12/2020 20:07	7,91	1	7,91	CHI
20201255485	SILVANIA	SV12310205	VIANOPOLIS	10/12/2020 12:12	10/12/2020 14:45	10/12/2020 12:12	10/12/2020 14:45	2,55	6	15,29	CHI
20201255315	FLORES DE GOIAS	10009431460	FLORES DE GOIAS	10/12/2020 12:13	11/12/2020 13:44	10/12/2020 12:13	11/12/2020 13:44	25,51	1	25,51	CHI
20201255317	GOIANIA	GN11343493	CARAJAS S2	10/12/2020 12:13	10/12/2020 15:08	10/12/2020 12:13	10/12/2020 15:08	2,91	12	34,88	CHI
20201255497	SANTA HELENA DE GOIAS	SH12301283	IPEGUARI	10/12/2020 12:13	10/12/2020 15:59	10/12/2020 12:13	10/12/2020 15:59	3,76	3	11,28	CHI
20201255615	POSSE	PS12257684	IACIARA S2	10/12/2020 12:14	10/12/2020 19:23	10/12/2020 12:14	10/12/2020 19:23	7,14	5	35,70	CHI
20201256455	MINEIROS	MY12184176	PARQUE DAS EMAS	10/12/2020 12:15	11/12/2020 10:30	10/12/2020 12:15	11/12/2020 10:30	22,25	7	155,72	CHI
20201255333	LUZIANIA	LZ12059742	CRISTALINA S2	10/12/2020 12:16	10/12/2020 14:58	10/12/2020 12:16	10/12/2020 14:58	2,69	5	13,47	CHI
20201256920	CRIXAS	CX12213587	SANTA TEREZINHA	10/12/2020 12:16	10/12/2020 18:01	10/12/2020 12:16	10/12/2020 18:01	5,74	2	11,47	CHI
20201256920	UIRAPURU	CX12213587	SANTA TEREZINHA	10/12/2020 12:16	10/12/2020 18:01	10/12/2020 12:16	10/12/2020 18:01	5,74	9	51,63	CHI
20201255342	JATAI	JT12264344	JATAI S1	10/12/2020 12:18	10/12/2020 19:32	10/12/2020 12:18	10/12/2020 19:32	7,22	3	21,66	CHI
20201255343	GOIANIA	10010519716	GOIANIA LESTE S1	10/12/2020 12:19	10/12/2020 17:57	10/12/2020 12:19	10/12/2020 17:57	5,64	1	5,64	CHI
20201255347	PIRACANJUBA	PJ12009149	PIRACANJUBA	10/12/2020 12:20	10/12/2020 20:42	10/12/2020 12:20	10/12/2020 20:42	8,36	1	8,36	CHI
20201255352	GOIANIA	GN11275719	GOYA S1	10/12/2020 12:21	10/12/2020 16:28	10/12/2020 16:19	10/12/2020 16:28	0,15	91	13,30	CHI
20201255388	SAO MIGUEL DO ARAGUAIA	SM12031421	SAO MIGUEL DO ARAGUAIA	10/12/2020 12:21	10/12/2020 14:08	10/12/2020 12:21	10/12/2020 14:08	1,77	17	30,07	CHI
20201255353	MINEIROS	MY21360788	PARQUE DAS EMAS	10/12/2020 12:22	10/12/2020 16:09	10/12/2020 12:22	10/12/2020 16:09	3,78	2	7,57	CHI
20201256124	CACU	CC11000019	CACHOEIRA ALTA	10/12/2020 12:22	10/12/2020 17:00	10/12/2020 12:22	10/12/2020 17:00	4,62	163	753,51	CHI
20201255701	ITAUCU	IX12049364	INHUMAS S2	10/12/2020 12:23	10/12/2020 16:38	10/12/2020 12:23	10/12/2020 16:38	4,25	8	33,99	CHI
20201255369	SANTA TEREZINHA DE GOIAS	SG21202039	SANTA TEREZINHA	10/12/2020 12:25	11/12/2020 01:59	10/12/2020 12:25	11/12/2020 01:59	13,56	1	13,56	CHI
20201255536	NOVA CRIXAS	NA12035650	NOVA CRIXAS	10/12/2020 12:26	14/12/2020 19:35	10/12/2020 12:26	11/12/2020 01:43	13,28	5	66,42	CHI
20201255536	NOVA CRIXAS	NA12035650	NOVA CRIXAS	10/12/2020 12:26	14/12/2020 19:35	10/12/2020 12:26	11/12/2020 03:28	15,02	2	30,05	CHI

20201255536	NOVA CRIXAS	NA12035650	NOVA CRIXAS	10/12/2020 12:26	14/12/2020 19:35	11/12/2020 04:38	12/12/2020 01:11	20,55	7	143,87	CHI
20201255536	NOVA CRIXAS	NA12035650	NOVA CRIXAS	10/12/2020 12:26	14/12/2020 19:35	10/12/2020 12:26	12/12/2020 02:34	38,14	4	152,55	CHI
20201255536	MUNDO NOVO DE GOIAS	NA12035650	NOVA CRIXAS	10/12/2020 12:26	14/12/2020 19:35	10/12/2020 12:26	12/12/2020 09:41	45,24	8	361,92	CHI
20201255536	NOVA CRIXAS	NA12035650	NOVA CRIXAS	10/12/2020 12:26	14/12/2020 19:35	10/12/2020 12:26	12/12/2020 09:41	45,24	1	45,24	CHI
20201255536	MUNDO NOVO DE GOIAS	NA10404101	NOVA CRIXAS	10/12/2020 12:26	14/12/2020 19:35	12/12/2020 17:45	12/12/2020 17:58	0,20	45	9,09	CHI
20201255536	NOVA CRIXAS	NA10404101	NOVA CRIXAS	10/12/2020 12:26	14/12/2020 19:35	12/12/2020 17:45	12/12/2020 17:58	0,20	3480	702,77	CHI
20201255536	NOVA CRIXAS	NA12035650	NOVA CRIXAS	10/12/2020 12:26	14/12/2020 19:35	10/12/2020 12:26	12/12/2020 21:06	56,66	3	169,99	CHI
20201255536	NOVA CRIXAS	NA12035650	NOVA CRIXAS	10/12/2020 12:26	14/12/2020 19:35	12/12/2020 21:09	12/12/2020 22:17	1,15	15	17,18	CHI
20201255536	MUNDO NOVO DE GOIAS	NA12035650	NOVA CRIXAS	10/12/2020 12:26	14/12/2020 19:35	12/12/2020 21:09	12/12/2020 22:17	1,15	8	9,16	CHI
20201255536	MUNDO NOVO DE GOIAS	NA12035650	NOVA CRIXAS	10/12/2020 12:26	14/12/2020 19:35	13/12/2020 13:36	13/12/2020 15:21	1,75	8	13,99	CHI
20201255536	NOVA CRIXAS	NA12035650	NOVA CRIXAS	10/12/2020 12:26	14/12/2020 19:35	13/12/2020 13:36	13/12/2020 15:21	1,75	12	20,98	CHI
20201255536	MUNDO NOVO DE GOIAS	NA12035650	NOVA CRIXAS	10/12/2020 12:26	14/12/2020 19:35	13/12/2020 16:34	14/12/2020 09:12	16,63	8	133,07	CHI
20201255536	NOVA CRIXAS	NA12035650	NOVA CRIXAS	10/12/2020 12:26	14/12/2020 19:35	13/12/2020 16:34	14/12/2020 09:12	16,63	12	199,61	CHI
20201255536	MUNDO NOVO DE GOIAS	NA12059971	NOVA CRIXAS	10/12/2020 12:26	14/12/2020 19:35	14/12/2020 10:39	14/12/2020 11:02	0,37	6	2,21	CHI
20201255536	NOVA CRIXAS	NA12035650	NOVA CRIXAS	10/12/2020 12:26	14/12/2020 19:35	10/12/2020 12:26	14/12/2020 19:35	103,15	9	928,36	CHI
20201255536	NOVA CRIXAS	NA13110897	NOVA CRIXAS	10/12/2020 12:26	14/12/2020 19:35	12/12/2020 23:01	14/12/2020 19:35	44,57	3	133,72	CHI
20201255392	GOIANIA	16009460	GOIANIA LESTE S2	10/12/2020 12:31	10/12/2020 14:52	10/12/2020 12:31	10/12/2020 14:52	2,34	1	2,34	CHI
20201255524	FORMOSA	FA11062256	ITQUIRA	10/12/2020 12:31	10/12/2020 16:33	10/12/2020 12:31	10/12/2020 16:33	4,02	197	791,67	CHI
20201256612	PIRACANJUBA	PJ12013344	MORRINHOS	10/12/2020 12:31	11/12/2020 10:03	10/12/2020 12:31	11/12/2020 10:03	21,52	12	258,21	CHI
20201255396	GOIANIA	10563763	REAL S2	10/12/2020 12:32	10/12/2020 15:20	10/12/2020 12:32	10/12/2020 15:20	2,79	1	2,79	CHI
20201255398	IPAMERI	580038440	IPAMERI	10/12/2020 12:32	10/12/2020 13:58	10/12/2020 12:32	10/12/2020 13:58	1,42	1	1,42	CHI
20201255401	RIO VERDE	RV12271319	CABRIUVA S2	10/12/2020 12:33	10/12/2020 14:40	10/12/2020 12:33	10/12/2020 14:40	2,10	3	6,30	CHI
20201255406	LEOPOLDO DE BULHOES	LB1246911	DAIA S1	10/12/2020 12:34	10/12/2020 21:20	10/12/2020 12:34	10/12/2020 21:20	8,76	2	17,51	CHI
20201255463	GOIANIA	GN12133833	GOIANIA LESTE S3	10/12/2020 12:34	10/12/2020 15:41	10/12/2020 12:34	10/12/2020 15:41	3,11	6	18,65	CHI
20201256381	TEREZOPOLIS DE GOIAS	TJ12389766	DAIA S2	10/12/2020 12:34	10/12/2020 18:13	10/12/2020 12:34	10/12/2020 18:13	5,64	10	56,44	CHI
20201255413	SILVANIA	660045278	BELA VISTA S2	10/12/2020 12:35	10/12/2020 18:29	10/12/2020 12:35	10/12/2020 18:29	5,91	1	5,91	CHI
20201255414	CAMPOS BELOS	CH12091794LD	SAO DOMINGOS	10/12/2020 12:35	10/12/2020 15:02	10/12/2020 12:35	10/12/2020 15:02	2,44	608	1484,53	CHI
20201255416	GUAPO	TR21364939	TRINDADE	10/12/2020 12:35	10/12/2020 21:01	10/12/2020 12:35	10/12/2020 21:01	8,42	1	8,42	CHI
20201255564	EDEIA	EA12000048	EDEIA	10/12/2020 12:36	10/12/2020 16:34	10/12/2020 12:36	10/12/2020 16:34	3,96	32	126,63	CHI
20201255429	CACHOEIRA ALTA	CA12094385	CACHOEIRA ALTA	10/12/2020 12:37	11/12/2020 15:01	10/12/2020 12:37	11/12/2020 15:01	26,40	1	26,40	CHI
20201255586	LUZIANIA	LZ11061777	MARAJOARA	10/12/2020 12:37	10/12/2020 14:03	10/12/2020 12:37	10/12/2020 14:03	1,42	26	36,91	CHI
20201255841	QUIRINOPOLIS	QI18271537TS	QUIRINOPOLIS	10/12/2020 12:37	10/12/2020 17:33	10/12/2020 12:37	10/12/2020 17:33	4,92	93	457,28	CHI
20201255437	GOIANIA	GN11151331	GOIANIA LESTE S3	10/12/2020 12:38	10/12/2020 15:31	10/12/2020 14:52	10/12/2020 15:31	0,65	3	1,95	CHI
20201255459	PORTELANDIA	PW21209829	PARQUE DAS EMAS	10/12/2020 12:39	10/12/2020 21:10	10/12/2020 12:39	10/12/2020 21:10	8,50	1	8,50	CHI
20201255466	SAO JOAO D ALIANCA	10017011840	SAO JOAO D ALIANCA	10/12/2020 12:41	10/12/2020 15:03	10/12/2020 12:41	10/12/2020 15:03	2,37	1	2,37	CHI
20201255473	CRISTALINA	KR21132668	CRISTALINA S2	10/12/2020 12:42	10/12/2020 16:20	10/12/2020 12:42	10/12/2020 16:20	3,63	1	3,63	CHI
20201255475	MINEIROS	MY12360754	PARQUE DAS EMAS	10/12/2020 12:42	11/12/2020 05:49	10/12/2020 12:42	11/12/2020 05:49	17,10	1	17,10	CHI
20201255508	HIDROLINA	UR12374716	URUACU	10/12/2020 12:42	10/12/2020 14:49	10/12/2020 12:42	10/12/2020 14:49	2,10	9	18,92	CHI
20201255484	ISRAELANDIA	03690214	IPORA	10/12/2020 12:44	10/12/2020 20:28	10/12/2020 12:44	10/12/2020 15:55	3,18	99	314,79	CHI
20201255484	ISRAELANDIA	03690214	IPORA	10/12/2020 12:44	10/12/2020 20:28	10/12/2020 12:44	10/12/2020 18:09	5,42	6	32,49	CHI
20201255484	FAZENDA NOVA	03690214	IPORA	10/12/2020 12:44	10/12/2020 20:28	10/12/2020 12:44	10/12/2020 18:09	5,42	149	806,92	CHI
20201255484	CORREGO DO OURO	03690214	IPORA	10/12/2020 12:44	10/12/2020 20:28	10/12/2020 12:44	10/12/2020 18:09	5,42	3	16,25	CHI
20201255484	FAZENDA NOVA	IS13070164	IPORA	10/12/2020 12:44	10/12/2020 20:28	10/12/2020 15:26	10/12/2020 18:09	2,73	2	5,46	CHI
20201255484	FAZENDA NOVA	03690214	IPORA	10/12/2020 12:44	10/12/2020 20:28	10/12/2020 12:44	10/12/2020 20:28	7,72	45	347,41	CHI
20201255484	FAZENDA NOVA	FN12060710	IPORA	10/12/2020 12:44	10/12/2020 20:28	10/12/2020 15:26	10/12/2020 20:28	5,03	3	15,10	CHI
20201255486	CRISTALINA	KR1261103	CRISTALINA S2	10/12/2020 12:44	10/12/2020 15:02	10/12/2020 12:44	10/12/2020 15:02	2,29	1	2,29	CHI
20201255491	APARECIDA DE GOIANIA	16435485	REAL S2	10/12/2020 12:45	11/12/2020 01:25	10/12/2020 12:45	11/12/2020 01:25	12,66	1	12,66	CHI
20201255494	GOIANESIA	GE21137460	GOIANESIA S1	10/12/2020 12:46	10/12/2020 15:36	10/12/2020 12:46	10/12/2020 15:36	2,83	1	2,83	CHI
20201255495	SENADOR CANEDO	SW11188919	SENADOR CANEDO	10/12/2020 12:46	10/12/2020 14:29	10/12/2020 12:46	10/12/2020 14:29	1,71	137	234,35	CHI
20201255507	ITAGUARU	230016534	ITABERAI S1	10/12/2020 12:49	10/12/2020 17:58	10/12/2020 12:49	10/12/2020 17:58	5,14	1	5,14	CHI
20201255509	LUZIANIA	120413875	RIO VERMELHO	10/12/2020 12:50	10/12/2020 14:47	10/12/2020 12:50	10/12/2020 14:47	1,94	1	1,94	CHI

20201255512	MARA ROSA	MQ21208265	MARA ROSA	10/12/2020 12:50	10/12/2020 17:30	10/12/2020 12:50	10/12/2020 17:30	4,66	1	4,66	CHI
20201255517	NIQUELANDIA	2750087886	BARRO ALTO	10/12/2020 12:52	10/12/2020 18:02	10/12/2020 12:52	10/12/2020 18:02	5,16	1	5,16	CHI
20201255575	QUIRINOPOLIS	QI13163447	SANTA HELENA S1	10/12/2020 12:53	10/12/2020 20:30	10/12/2020 17:11	10/12/2020 20:30	3,32	10	33,19	CHI
20201255526	ITUMBIARA	690077816	ITUMBIARA VELHA S1	10/12/2020 12:54	10/12/2020 18:50	10/12/2020 12:54	10/12/2020 18:50	5,93	1	5,93	CHI
20201255527	CIDADE OCIDENTAL	10000159784	MARAJOARA	10/12/2020 12:54	10/12/2020 15:40	10/12/2020 12:54	10/12/2020 15:40	2,76	1	2,76	CHI
20201255530	MINEIROS	MY12043894RE	PARQUE DAS EMAS	10/12/2020 12:54	10/12/2020 14:19	10/12/2020 12:54	10/12/2020 14:19	1,41	102	143,57	CHI
20201255534	AMARALINA	MU12192418	MARA ROSA	10/12/2020 12:55	10/12/2020 15:39	10/12/2020 12:55	10/12/2020 15:39	2,73	1	2,73	CHI
20201255534	PORANGATU	MU12192418	MARA ROSA	10/12/2020 12:55	10/12/2020 15:39	10/12/2020 12:55	10/12/2020 15:39	2,73	1	2,73	CHI
20201255540	GOIANIA	GN12001605	AEROPORTO S2	10/12/2020 12:56	10/12/2020 14:14	10/12/2020 12:56	10/12/2020 14:14	1,30	74	95,95	CHI
20201255548	NEROPOLIS	NR12008339	NEROPOLIS S2	10/12/2020 12:57	10/12/2020 18:13	10/12/2020 12:57	10/12/2020 18:13	5,26	232	1220,71	CHI
20201255552	NIQUELANDIA	2750080430	NIQUELANDIA SUBTRANSMISSAO	10/12/2020 12:57	10/12/2020 19:02	10/12/2020 12:57	10/12/2020 19:02	6,07	1	6,07	CHI
20201255696	CATALAO	CT12130976	CATALAO S1	10/12/2020 12:57	10/12/2020 16:40	10/12/2020 12:57	10/12/2020 16:40	3,71	12	44,57	CHI
20201255764	TAQUARAL DE GOIAS	TQ12000107	ITABERAI S1	10/12/2020 12:57	10/12/2020 15:37	10/12/2020 12:57	10/12/2020 15:37	2,65	13	34,48	CHI
20201257543	APARECIDA DE GOIANIA	AP11251490	INDEPENDENCIA S1	10/12/2020 12:58	10/12/2020 19:25	10/12/2020 12:58	10/12/2020 19:25	6,45	180	1160,70	CHI
20201255561	ANAPOLIS	10019363891	ANAPOLIS UNIVERSITARIO S2	10/12/2020 12:59	10/12/2020 21:47	10/12/2020 12:59	10/12/2020 21:47	8,80	1	8,80	CHI
20201255562	CRISTALINA	KR12412111	CRISTALINA S2	10/12/2020 12:59	10/12/2020 15:37	10/12/2020 12:59	10/12/2020 15:37	2,63	7	18,39	CHI
20201255566	GOIANIA	GN11002256	CAMPINAS S3	10/12/2020 12:59	10/12/2020 18:27	10/12/2020 12:59	10/12/2020 18:27	5,46	45	245,77	CHI
20201255630	PALMEIRAS DE GOIAS	PL12000219	PALMEIRAS	10/12/2020 13:00	10/12/2020 15:00	10/12/2020 13:00	10/12/2020 15:00	1,99	5	9,97	CHI
20201256141	ACREUNA	EU13240315	ACREUNA	10/12/2020 13:00	10/12/2020 15:50	10/12/2020 13:00	10/12/2020 15:50	2,83	2054	5818,53	CHI
20201256425	ORIZONA	OZ12300550	PIRES DO RIO S2	10/12/2020 13:00	10/12/2020 17:41	10/12/2020 13:00	10/12/2020 17:41	4,68	53	248,05	CHI
20201254691	ORIZONA	OZ21185955	PIRES DO RIO S2	10/12/2020 13:02	10/12/2020 16:49	10/12/2020 16:13	10/12/2020 16:49	0,60	1	0,60	CHI
20201255587	GOIANIA	GN11001808	ATLANTICO S2	10/12/2020 13:02	10/12/2020 16:42	10/12/2020 13:02	10/12/2020 16:42	3,66	84	307,25	CHI
20201255616	MINEIROS	02430414	CHAPADAO DO CEU	10/12/2020 13:03	11/12/2020 16:53	10/12/2020 13:52	10/12/2020 14:13	0,34	6	2,04	CHI
20201255616	SERRANOPOLIS	02430414	CHAPADAO DO CEU	10/12/2020 13:03	11/12/2020 16:53	10/12/2020 13:52	10/12/2020 14:13	0,34	34	11,55	CHI
20201255616	CHAPADAO DO CEU	02430414	CHAPADAO DO CEU	10/12/2020 13:03	11/12/2020 16:53	10/12/2020 13:52	10/12/2020 14:13	0,34	11	3,74	CHI
20201255616	SERRANOPOLIS	DJ10418274	CHAPADAO DO CEU	10/12/2020 13:03	11/12/2020 16:53	10/12/2020 13:03	10/12/2020 15:17	2,23	40	89,11	CHI
20201255616	SERRANOPOLIS	DJ12135998	CHAPADAO DO CEU	10/12/2020 13:03	11/12/2020 16:53	10/12/2020 13:03	10/12/2020 17:19	4,26	3	12,79	CHI
20201255616	SERRANOPOLIS	DJ10418274	CHAPADAO DO CEU	10/12/2020 13:03	11/12/2020 16:53	10/12/2020 17:52	10/12/2020 18:30	0,64	3	1,92	CHI
20201255616	JATAI	JT10400617	JATAI S1	10/12/2020 13:03	11/12/2020 16:53	10/12/2020 18:49	10/12/2020 18:54	0,08	41	3,46	CHI
20201255616	JATAI	JT10400238	JATAI S1	10/12/2020 13:03	11/12/2020 16:53	10/12/2020 18:49	10/12/2020 19:00	0,19	39	7,32	CHI
20201255616	SERRANOPOLIS	JT10400238	CHAPADAO DO CEU	10/12/2020 13:03	11/12/2020 16:53	10/12/2020 18:49	10/12/2020 19:00	0,19	45	8,45	CHI
20201255616	SERRANOPOLIS	JT10400238	JATAI S1	10/12/2020 13:03	11/12/2020 16:53	10/12/2020 18:49	10/12/2020 19:00	0,19	6	1,13	CHI
20201255616	MINEIROS	JT10400238	CHAPADAO DO CEU	10/12/2020 13:03	11/12/2020 16:53	10/12/2020 18:49	10/12/2020 19:00	0,19	20	3,76	CHI
20201255616	MINEIROS	02430414	CHAPADAO DO CEU	10/12/2020 13:03	11/12/2020 16:53	11/12/2020 04:27	11/12/2020 09:19	4,87	6	29,24	CHI
20201255616	SERRANOPOLIS	02430414	CHAPADAO DO CEU	10/12/2020 13:03	11/12/2020 16:53	11/12/2020 04:27	11/12/2020 09:19	4,87	23	112,10	CHI
20201255616	SERRANOPOLIS	DJ13164066	CHAPADAO DO CEU	10/12/2020 13:03	11/12/2020 16:53	11/12/2020 04:27	11/12/2020 09:19	4,87	3	14,62	CHI
20201255616	SERRANOPOLIS	02430414	CHAPADAO DO CEU	10/12/2020 13:03	11/12/2020 16:53	11/12/2020 04:27	11/12/2020 11:25	6,98	11	76,79	CHI
20201255616	CHAPADAO DO CEU	02430414	CHAPADAO DO CEU	10/12/2020 13:03	11/12/2020 16:53	11/12/2020 04:27	11/12/2020 12:36	8,15	5	40,76	CHI
20201255616	CHAPADAO DO CEU	02430414	CHAPADAO DO CEU	10/12/2020 13:03	11/12/2020 16:53	11/12/2020 04:27	11/12/2020 13:37	9,17	6	54,99	CHI
20201255616	MINEIROS	DJ13164077	CHAPADAO DO CEU	10/12/2020 13:03	11/12/2020 16:53	11/12/2020 13:51	11/12/2020 14:02	0,18	6	1,11	CHI
20201255616	SERRANOPOLIS	DJ13164077	CHAPADAO DO CEU	10/12/2020 13:03	11/12/2020 16:53	11/12/2020 13:51	11/12/2020 14:02	0,18	34	6,29	CHI
20201255616	CHAPADAO DO CEU	DJ13164077	CHAPADAO DO CEU	10/12/2020 13:03	11/12/2020 16:53	11/12/2020 13:51	11/12/2020 14:02	0,18	5	0,92	CHI
20201255616	SERRANOPOLIS	DJ12136065	CHAPADAO DO CEU	10/12/2020 13:03	11/12/2020 16:53	10/12/2020 13:03	11/12/2020 15:59	26,93	1	26,93	CHI
20201255616	SERRANOPOLIS	DJ12136065	CHAPADAO DO CEU	10/12/2020 13:03	11/12/2020 16:53	10/12/2020 13:03	11/12/2020 16:53	27,83	1	27,83	CHI
20201256464	BURITINOPOLIS	PS12189370	IACIARA S2	10/12/2020 13:04	10/12/2020 19:26	10/12/2020 13:04	10/12/2020 19:26	6,36	2	12,71	CHI
20201256464	POSSE	PS12189370	IACIARA S2	10/12/2020 13:04	10/12/2020 19:26	10/12/2020 13:04	10/12/2020 19:26	6,36	4	25,42	CHI
20201256464	MAMBAI	PS12189370	IACIARA S2	10/12/2020 13:04	10/12/2020 19:26	10/12/2020 13:04	10/12/2020 19:26	6,36	28	177,96	CHI
20201255598	LUZIANIA	3200072505	RIO VERMELHO	10/12/2020 13:05	10/12/2020 16:56	10/12/2020 13:05	10/12/2020 16:56	3,85	1	3,85	CHI
20201255601	FORMOSA	610020699	ITUIQUIRA	10/12/2020 13:05	10/12/2020 13:45	10/12/2020 13:05	10/12/2020 13:45	0,65	1	0,65	CHI
20201255609	PIRACANJUBA	60050573	PIRACANJUBA	10/12/2020 13:07	10/12/2020 18:46	10/12/2020 13:07	10/12/2020 18:46	5,65	1	5,65	CHI
20201255610	CORUMBAIBA	CI12041817	VILA CORUMBA	10/12/2020 13:07	11/12/2020 00:49	10/12/2020 13:07	11/12/2020 00:49	11,69	2	23,39	CHI

20201255611	GOIANIA	12355999	REAL S1	10/12/2020 13:07	10/12/2020 14:48	10/12/2020 13:07	10/12/2020 14:48	1,68	1	1,68	CHI
20201255612	COLINAS DO SUL	TI21155526	MINACU	10/12/2020 13:07	10/12/2020 16:38	10/12/2020 13:07	10/12/2020 16:38	3,51	2	7,01	CHI
20201255613	GOIAS	90093380	GOIAS	10/12/2020 13:07	10/12/2020 17:55	10/12/2020 13:07	10/12/2020 17:55	4,78	1	4,78	CHI
20201255620	NIQUELANDIA	NQ21136456	NIQUELANDIA SUBTRANSMISSAO	10/12/2020 13:09	11/12/2020 12:03	10/12/2020 13:09	11/12/2020 12:03	22,89	1	22,89	CHI
20201255767	PIRACANJUBA	PJ12072826	PIRACANJUBA	10/12/2020 13:09	10/12/2020 15:15	10/12/2020 13:09	10/12/2020 15:15	2,09	17	35,51	CHI
20201255628	ITUMBIARA	690076691	ITUMBIARA VELHA S1	10/12/2020 13:10	10/12/2020 21:42	10/12/2020 13:10	10/12/2020 21:42	8,52	1	8,52	CHI
20201255629	GOIANIA	15057410	ATLANTICO S1	10/12/2020 13:11	10/12/2020 14:29	10/12/2020 13:11	10/12/2020 14:29	1,29	1	1,29	CHI
20201255633	ANAPOLIS	AN11214762	JUNDIAI S2	10/12/2020 13:12	10/12/2020 17:00	10/12/2020 13:12	10/12/2020 17:00	3,81	23	87,64	CHI
20201255639	SIMOLANDIA	SA11180533	IACIARA S2	10/12/2020 13:13	10/12/2020 17:14	10/12/2020 13:13	10/12/2020 17:14	4,01	1	4,01	CHI
20201255641	MINEIROS	MY12324703	PARQUE DAS EMAS	10/12/2020 13:13	11/12/2020 20:00	10/12/2020 13:13	11/12/2020 20:00	30,78	1	30,78	CHI
20201255649	QUIRINOPOLIS	QI21049541	QUIRINOPOLIS	10/12/2020 13:14	11/12/2020 10:15	10/12/2020 13:14	11/12/2020 10:15	21,01	1	21,01	CHI
20201255771	APARECIDA DE GOIANIA	AP11000064	ANHANGUERA	10/12/2020 13:15	10/12/2020 17:44	10/12/2020 13:15	10/12/2020 17:44	4,48	82	367,50	CHI
20201255662	SANTO ANTONIO DA BARRA	BZ21355953	ACREUNA	10/12/2020 13:16	10/12/2020 20:20	10/12/2020 13:16	10/12/2020 20:20	7,06	1	7,06	CHI
20201255677	ITUMBIARA	IT12352618	PARANAIBA	10/12/2020 13:18	10/12/2020 16:20	10/12/2020 13:18	10/12/2020 16:20	3,03	1	3,03	CHI
20201255831	GOIAS	MD12062634RE	ITABERAI S1	10/12/2020 13:18	10/12/2020 16:20	10/12/2020 13:18	10/12/2020 16:20	3,03	6	18,19	CHI
20201255831	ITABERAI	MD12062634RE	ITABERAI S1	10/12/2020 13:18	10/12/2020 16:20	10/12/2020 13:18	10/12/2020 16:20	3,03	4	12,13	CHI
20201255831	MOSSAMEDES	MD12062634RE	ITABERAI S1	10/12/2020 13:18	10/12/2020 16:20	10/12/2020 13:18	10/12/2020 16:20	3,03	209	633,56	CHI
20201255689	APARECIDA DE GOIANIA	200094440	INDEPENDENCIA S2	10/12/2020 13:20	10/12/2020 15:04	10/12/2020 13:20	10/12/2020 15:04	1,73	1	1,73	CHI
20201255690	JATAI	290333982	JATAI S3	10/12/2020 13:20	11/12/2020 08:05	10/12/2020 13:20	11/12/2020 08:05	18,74	1	18,74	CHI
20201255693	SILVANIA	SV21100896	VIANOPODIS	10/12/2020 13:21	10/12/2020 15:58	10/12/2020 13:21	10/12/2020 15:58	2,62	2	5,23	CHI
20201255694	SAO MIGUEL DO ARAGUAIA	SM11166514	SAO MIGUEL DO ARAGUAIA	10/12/2020 13:21	10/12/2020 15:20	10/12/2020 13:21	10/12/2020 15:20	1,98	23	45,57	CHI
202012179349	MINACU	IH21208467	MINACU	10/12/2020 13:22	11/12/2020 22:55	11/12/2020 12:03	11/12/2020 13:06	1,06	2	2,11	CHI
202012179349	MINACU	IH21135022	MINACU	10/12/2020 13:22	11/12/2020 22:55	10/12/2020 13:22	11/12/2020 22:55	33,55	2	67,10	CHI
202012179349	MINACU	IH21232191	MINACU	10/12/2020 13:22	11/12/2020 22:55	11/12/2020 10:43	11/12/2020 22:55	12,20	2	24,39	CHI
20201255706	JATAI	JT21296389	JATAI S1	10/12/2020 13:23	11/12/2020 13:25	10/12/2020 13:23	11/12/2020 13:25	24,02	1	24,02	CHI
20201255707	TRINDADE	TR12001811	GOYA S1	10/12/2020 13:23	10/12/2020 16:00	10/12/2020 13:23	10/12/2020 16:00	2,61	8	20,85	CHI
20201255709	ITAJA	IJ12200626	ITAJA S2	10/12/2020 13:23	10/12/2020 14:13	10/12/2020 13:23	10/12/2020 14:13	0,82	7	5,76	CHI
20201256039	CACU	CC12235896	CACHOEIRA ALTA	10/12/2020 13:23	11/12/2020 21:58	10/12/2020 13:23	10/12/2020 18:55	5,53	7	38,73	CHI
20201256039	CACU	CC12235896	CACHOEIRA ALTA	10/12/2020 13:23	11/12/2020 21:58	10/12/2020 13:23	10/12/2020 21:15	7,86	7	55,01	CHI
20201256039	JATAI	CC12235896	CACHOEIRA ALTA	10/12/2020 13:23	11/12/2020 21:58	10/12/2020 13:23	10/12/2020 21:15	7,86	9	70,72	CHI
20201256039	CACU	CC12235896	CACHOEIRA ALTA	10/12/2020 13:23	11/12/2020 21:58	10/12/2020 13:23	11/12/2020 21:58	32,58	2	65,15	CHI
20201255715	CALDAS NOVAS	CN21186901	CALDAS NOVAS S2	10/12/2020 13:24	10/12/2020 17:53	10/12/2020 13:24	10/12/2020 17:53	4,48	1	4,48	CHI
20201255718	QUIRINOPOLIS	QI31054866	QUIRINOPOLIS	10/12/2020 13:24	10/12/2020 17:02	10/12/2020 13:24	10/12/2020 17:02	3,63	1	3,63	CHI
20201255721	SERRANOPOLIS	SX12260521	JATAI S1	10/12/2020 13:25	10/12/2020 17:28	10/12/2020 13:25	10/12/2020 17:28	4,04	14	56,60	CHI
20201255722	GOIANIA	14972610	CARAJAS S2	10/12/2020 13:25	10/12/2020 15:08	10/12/2020 13:25	10/12/2020 15:08	1,70	1	1,70	CHI
20201255731	CAMPO ALEGRE DE GOIAS	CM12203138	CAMPO ALEGRE DE GOIAS	10/12/2020 13:27	10/12/2020 18:06	10/12/2020 13:27	10/12/2020 18:06	4,65	6	27,87	CHI
20201255736	MORRO AGUDO DE GOIAS	MS12335823	ITAPURANGA	10/12/2020 13:28	10/12/2020 21:23	10/12/2020 13:28	10/12/2020 21:23	7,91	2	15,82	CHI
20201255739	APARECIDA DE GOIANIA	17229376	INDEPENDENCIA S1	10/12/2020 13:29	10/12/2020 15:41	10/12/2020 13:29	10/12/2020 15:41	2,20	1	2,20	CHI
20201255754	CRISTALINA	KR11184825	CRISTALINA S1	10/12/2020 13:31	10/12/2020 15:38	10/12/2020 13:31	10/12/2020 15:38	2,10	1	2,10	CHI
20201255761	GOIANIA	10020165097	GOIANIA LESTE S2	10/12/2020 13:32	10/12/2020 15:29	10/12/2020 13:32	10/12/2020 15:29	1,94	1	1,94	CHI
20201255762	SAO MIGUEL DO ARAGUAIA	10003665990	SAO MIGUEL DO ARAGUAIA	10/12/2020 13:32	10/12/2020 19:28	10/12/2020 13:32	10/12/2020 19:28	5,93	1	5,93	CHI
20201255769	PORANGATU	BX12292422	SAO MIGUEL DO ARAGUAIA	10/12/2020 13:33	10/12/2020 16:54	10/12/2020 13:33	10/12/2020 16:54	3,34	1	3,34	CHI
20201255769	BONOPOLIS	BX12292422	SAO MIGUEL DO ARAGUAIA	10/12/2020 13:33	10/12/2020 16:54	10/12/2020 13:33	10/12/2020 16:54	3,34	32	106,99	CHI
20201255966	MINACU	IH12334428	MINACU	10/12/2020 13:33	10/12/2020 20:04	10/12/2020 13:33	10/12/2020 20:04	6,51	188	1224,45	CHI
20201257037	NOVA AMERICA	NM12199851	RUBIATABA	10/12/2020 13:34	10/12/2020 19:19	10/12/2020 13:34	10/12/2020 19:19	5,74	12	68,86	CHI
20201257147	FLORES DE GOIAS	FB11383395	FLORES DE GOIAS	10/12/2020 13:34	11/12/2020 12:03	10/12/2020 13:34	11/12/2020 12:03	22,47	37	831,40	CHI
20201258395	GOIAS	GS12085888	GOIAS	10/12/2020 13:36	11/12/2020 11:14	10/12/2020 13:36	11/12/2020 11:14	21,63	23	497,39	CHI
20201255791	PIRACANJUBA	10007939467	PIRACANJUBA	10/12/2020 13:37	11/12/2020 08:21	10/12/2020 13:37	11/12/2020 08:21	18,73	1	18,73	CHI
20201255795	LUZIANIA	LZ11029344	RIO VERMELHO	10/12/2020 13:38	10/12/2020 15:08	10/12/2020 13:38	10/12/2020 15:08	1,50	99	148,25	CHI
20201255796	VICENTINOPOLIS	VI12218178	VICENTINOPOLIS	10/12/2020 13:38	10/12/2020 22:48	10/12/2020 13:38	10/12/2020 22:48	9,15	5	45,76	CHI
20201256030	CATALAO	10008288540	CATALAO S2	10/12/2020 13:38	10/12/2020 15:45	10/12/2020 13:38	10/12/2020 15:45	2,11	1	2,11	CHI

20201255798	JATAI	10005976675	JATAI S2	10/12/2020 13:39	11/12/2020 09:33	10/12/2020 13:39	11/12/2020 09:33	19,90	1	19,90	CHI
20201255922	JATAI	JT12398520	JATAI S1	10/12/2020 13:39	10/12/2020 16:31	10/12/2020 13:39	10/12/2020 16:31	2,86	9	25,75	CHI
20201256114	LUZIANIA	LZ12383052LD	CRISTALINA S2	10/12/2020 13:39	10/12/2020 20:33	10/12/2020 13:39	10/12/2020 20:33	6,90	60	413,82	CHI
20201255833	GOIANIA	GN11158066	GOYA S2	10/12/2020 13:42	10/12/2020 17:28	10/12/2020 13:42	10/12/2020 17:28	3,77	152	573,00	CHI
20201255819	TRINDADE	11698950	GOYA S2	10/12/2020 13:43	10/12/2020 20:47	10/12/2020 13:43	10/12/2020 20:47	7,06	1	7,06	CHI
20201255821	SILVANIA	SV21056826	VIANOPOLIS	10/12/2020 13:43	10/12/2020 17:11	10/12/2020 13:43	10/12/2020 17:11	3,46	1	3,46	CHI
20201255822	FORMOSA	FA11129991	ITIQUEIRA	10/12/2020 13:43	10/12/2020 16:43	10/12/2020 15:30	10/12/2020 16:43	1,21	28	33,91	CHI
20201255823	ITUMBIARA	IT21415954	CACHOEIRA DOURADA	10/12/2020 13:43	11/12/2020 01:38	10/12/2020 13:43	11/12/2020 01:38	11,91	1	11,91	CHI
20201255830	CRISTALINA	KR21203335	PAMPLONA	10/12/2020 13:44	10/12/2020 21:16	10/12/2020 13:44	10/12/2020 21:16	7,53	2	15,06	CHI
20201255837	GOIAS	IK21299928	GOIAS	10/12/2020 13:45	11/12/2020 13:21	10/12/2020 13:45	11/12/2020 13:21	23,59	1	23,59	CHI
20201255840	PLANALTINA	2960132975	PLANALTINA	10/12/2020 13:46	10/12/2020 15:03	10/12/2020 13:46	10/12/2020 15:03	1,27	1	1,27	CHI
20201255844	ALVORADA DO NORTE	AQ21099891	IACIARA S2	10/12/2020 13:47	10/12/2020 16:58	10/12/2020 13:47	10/12/2020 16:58	3,17	1	3,17	CHI
20201255846	LUZIANIA	LZ21192754	CRISTALINA S2	10/12/2020 13:47	10/12/2020 18:08	10/12/2020 13:47	10/12/2020 18:08	4,34	1	4,34	CHI
20201255851	TRINDADE	40006281	TRINDADE	10/12/2020 13:48	10/12/2020 16:56	10/12/2020 13:48	10/12/2020 16:56	3,12	1	3,12	CHI
20201255852	RUBIATABA	RB21312153	RUBIATABA	10/12/2020 13:48	10/12/2020 17:23	10/12/2020 13:48	10/12/2020 17:23	3,57	1	3,57	CHI
20201255859	CRISTALINA	KR10406854	CRISTALINA S2	10/12/2020 13:48	10/12/2020 20:17	10/12/2020 13:48	10/12/2020 15:19	1,51	77	116,27	CHI
20201255859	CRISTALINA	KR13400534	CRISTALINA S2	10/12/2020 13:48	10/12/2020 20:17	10/12/2020 13:48	10/12/2020 18:44	4,94	151	745,23	CHI
20201255859	CRISTALINA	KR13400535	CRISTALINA S2	10/12/2020 13:48	10/12/2020 20:17	10/12/2020 13:48	10/12/2020 20:17	6,48	95	615,52	CHI
20201255857	ALEXANIA	AX21075900	ALEXANIA	10/12/2020 13:49	10/12/2020 22:14	10/12/2020 13:49	10/12/2020 22:14	8,41	1	8,41	CHI
20201255858	ANAPOLIS	21198524	DAIA S1	10/12/2020 13:49	10/12/2020 20:02	10/12/2020 13:49	10/12/2020 20:02	6,21	1	6,21	CHI
20201255865	PADRE BERNARDO	9980026874	PADRE BERNARDO	10/12/2020 13:50	10/12/2020 15:57	10/12/2020 13:50	10/12/2020 15:57	2,11	1	2,11	CHI
20201255869	PADRE BERNARDO	2760031970	PADRE BERNARDO	10/12/2020 13:50	10/12/2020 16:22	10/12/2020 13:50	10/12/2020 16:22	2,52	1	2,52	CHI
20201255984	PORANGATU	PO12297101	MARA ROSA	10/12/2020 13:51	10/12/2020 16:24	10/12/2020 13:51	10/12/2020 16:24	2,54	7	17,81	CHI
20201255887	JARAGUA	SF21017441	SAO FRANCISCO DE GOIAS	10/12/2020 13:53	10/12/2020 17:08	10/12/2020 13:53	10/12/2020 17:08	3,24	1	3,24	CHI
20201255894	FORMOSA	FA11245398	ITIQUEIRA	10/12/2020 13:55	11/12/2020 10:45	10/12/2020 13:55	11/12/2020 10:45	20,84	12	250,03	CHI
20201255895	CATALAO	CT12166743RE	CATALAO S1	10/12/2020 13:55	10/12/2020 17:55	10/12/2020 13:55	10/12/2020 17:55	3,99	35	139,69	CHI
20201255906	ARAGOIANIA	680015449	GUAPO S2	10/12/2020 13:57	10/12/2020 20:07	10/12/2020 13:57	10/12/2020 20:07	6,16	1	6,16	CHI
20201255908	ITARUMA	IM21214258	CACHOEIRA ALTA	10/12/2020 13:57	10/12/2020 22:41	10/12/2020 13:57	10/12/2020 22:41	8,73	1	8,73	CHI
20201255914	MINEIROS	MY21072209	PARQUE DAS EMAS	10/12/2020 13:58	11/12/2020 11:16	10/12/2020 13:58	11/12/2020 11:16	21,30	1	21,30	CHI
20201255918	CACU	CC21074339	CACHOEIRA ALTA	10/12/2020 13:59	10/12/2020 18:30	10/12/2020 13:59	10/12/2020 18:30	4,52	1	4,52	CHI
20201255935	CRIXAS	CX12391851	SANTA TEREZINHA	10/12/2020 14:00	12/12/2020 14:40	10/12/2020 14:00	12/12/2020 14:40	48,65	2	97,31	CHI
20201255937	GOIANIA	GN12323267	CEPAIGO S1	10/12/2020 14:01	10/12/2020 16:13	10/12/2020 14:01	10/12/2020 16:13	2,20	78	171,60	CHI
20201255953	SANTO ANTONIO DO DESCOBERTO	2210132211	AGUAS LINDAS DE GOIAS S2	10/12/2020 14:02	10/12/2020 21:37	10/12/2020 14:02	10/12/2020 21:37	7,57	1	7,57	CHI
20201257223	MONTES CLAROS DE GOIAS	ME12088922	IPORA	10/12/2020 14:03	10/12/2020 18:25	10/12/2020 14:03	10/12/2020 18:25	4,36	17	74,12	CHI
20201258367	AMARALINA	LC12050751	MARA ROSA	10/12/2020 14:03	11/12/2020 10:35	10/12/2020 14:03	11/12/2020 10:35	20,52	12	246,26	CHI
20201258367	MARA ROSA	LC12050751	MARA ROSA	10/12/2020 14:03	11/12/2020 10:35	10/12/2020 14:03	11/12/2020 10:35	20,52	5	102,61	CHI
20201254617	JOVIANIA	JV21052747	GOIATUBA S1	10/12/2020 14:04	10/12/2020 18:28	10/12/2020 14:04	10/12/2020 18:28	4,39	1	4,39	CHI
20201255965	LUZIANIA	LZ11253479	VIANOPOLIS	10/12/2020 14:04	10/12/2020 21:53	10/12/2020 14:04	10/12/2020 21:53	7,81	1	7,81	CHI
20201256241	PARAUNA	PU12361897	PARAUNA	10/12/2020 14:04	11/12/2020 06:31	10/12/2020 14:04	11/12/2020 06:31	16,45	4	65,78	CHI
20201256241	JANDAIA	PU12361897	PARAUNA	10/12/2020 14:04	11/12/2020 06:31	10/12/2020 14:04	11/12/2020 06:31	16,45	3	49,34	CHI
20201255970	COCALZINHO DE GOIAS	ZN12154765	AGUAS LINDAS DE GOIAS S2	10/12/2020 14:05	10/12/2020 17:22	10/12/2020 14:05	10/12/2020 17:22	3,28	4	13,13	CHI
20201255979	SAO LUIS DE MONTES BELOS	10031442950	SAO LUIZ DOS MONTES BELOS	10/12/2020 14:06	10/12/2020 16:32	10/12/2020 14:06	10/12/2020 16:32	2,43	1	2,43	CHI
20201255981	SAO JOAO D ALIANCA	JL12268121	SAO JOAO D ALIANCA	10/12/2020 14:06	10/12/2020 16:45	10/12/2020 14:06	10/12/2020 16:45	2,64	8	21,13	CHI
20201255992	HIDROLANDIA	PJ12000097	PIRACANJUBA	10/12/2020 14:07	10/12/2020 16:06	10/12/2020 14:07	10/12/2020 16:06	1,97	8	15,76	CHI
20201255992	PIRACANJUBA	PJ12000097	PIRACANJUBA	10/12/2020 14:07	10/12/2020 16:06	10/12/2020 14:07	10/12/2020 16:06	1,97	36	70,92	CHI
20201255997	PETROLINA DE GOIAS	PG10395831	PETROLINA	10/12/2020 14:07	11/12/2020 05:14	10/12/2020 14:07	10/12/2020 17:36	3,49	225	784,19	CHI
20201255997	PETROLINA DE GOIAS	PG13298099	PETROLINA	10/12/2020 14:07	11/12/2020 05:14	10/12/2020 14:07	11/12/2020 05:14	15,12	74	1118,70	CHI
20201255995	CACU	CC21202723	CACHOEIRA ALTA	10/12/2020 14:08	11/12/2020 16:50	10/12/2020 14:08	11/12/2020 16:50	26,70	1	26,70	CHI
20201255996	PARAUNA	PU12391520	FIRMINOPOLIS S2	10/12/2020 14:08	10/12/2020 16:38	10/12/2020 14:08	10/12/2020 16:38	2,49	2	4,99	CHI
20201255999	IPAMERI	IP12152494RE	IPAMERI	10/12/2020 14:08	10/12/2020 22:06	10/12/2020 14:08	10/12/2020 22:06	7,96	27	214,81	CHI
20201256013	MINEIROS	MY12193784	PARQUE DAS EMAS	10/12/2020 14:11	11/12/2020 04:34	10/12/2020 14:11	11/12/2020 04:34	14,38	3	43,15	CHI

20201256020	LEOPOLDO DE BULHOES	LB21353348	DAIA S2	10/12/2020 14:13	10/12/2020 20:16	10/12/2020 14:13	10/12/2020 20:16	6,04	1	6,04	CHI
20201256098	ITARUMA	IM12058351	CACHOEIRA ALTA	10/12/2020 14:14	11/12/2020 14:32	10/12/2020 14:14	10/12/2020 18:03	3,82	4	15,26	CHI
20201256098	ITARUMA	IM12058351	CACHOEIRA ALTA	10/12/2020 14:14	11/12/2020 14:32	10/12/2020 14:14	10/12/2020 14:32	24,29	14	340,02	CHI
20201256100	JUSSARA	JR12033556RE	BRITANIA	10/12/2020 14:15	10/12/2020 16:10	10/12/2020 14:15	10/12/2020 16:10	1,91	164	313,79	CHI
20201256100	FAZENDA NOVA	JR12033556RE	BRITANIA	10/12/2020 14:15	10/12/2020 16:10	10/12/2020 14:15	10/12/2020 16:10	1,91	9	17,22	CHI
20201256111	CIDADE OCIDENTAL	DH11199629	MARAJOARA	10/12/2020 14:15	10/12/2020 20:57	10/12/2020 14:15	10/12/2020 20:57	6,69	23	153,79	CHI
20201256037	PARAUNA	980050662	PARAUNA	10/12/2020 14:16	10/12/2020 16:00	10/12/2020 14:16	10/12/2020 16:00	1,72	1	1,72	CHI
20201256043	LUZIANIA	LZ21335954	MARAJOARA	10/12/2020 14:17	10/12/2020 16:18	10/12/2020 14:17	10/12/2020 16:18	2,01	1	2,01	CHI
20201256044	MONTIVIDIU	MV12260782	MONTIVIDIU T	10/12/2020 14:17	11/12/2020 04:39	10/12/2020 14:17	11/12/2020 04:39	14,35	6	86,12	CHI
20201256044	CAIAPONIA	MV12260782	MONTIVIDIU T	10/12/2020 14:17	11/12/2020 04:39	10/12/2020 14:17	11/12/2020 04:39	14,35	1	14,35	CHI
20201256050	AGUA FRIA DE GOIAS	PI21062249	SAO JOAO D ALIANCA	10/12/2020 14:18	11/12/2020 10:46	10/12/2020 14:18	11/12/2020 10:46	20,47	2	40,93	CHI
20201256051	CACU	CC21154775	CACHOEIRA ALTA	10/12/2020 14:18	11/12/2020 01:09	10/12/2020 14:18	11/12/2020 01:09	10,85	1	10,85	CHI
20201256052	LUZIANIA	3200025266	MARAJOARA	10/12/2020 14:18	10/12/2020 16:29	10/12/2020 14:18	10/12/2020 16:29	2,17	1	2,17	CHI
20201256807	OURO VERDE DE GOIAS	OV12384197	NEROPOLIS S1	10/12/2020 14:18	10/12/2020 17:07	10/12/2020 14:18	10/12/2020 17:07	2,80	2	5,61	CHI
20201256807	ANAPOLIS	OV12384197	NEROPOLIS S1	10/12/2020 14:18	10/12/2020 17:07	10/12/2020 14:18	10/12/2020 17:07	2,80	5	14,02	CHI
20201256453	CUMARI	TH13028686	CATALAO S1	10/12/2020 14:21	11/12/2020 01:39	10/12/2020 20:14	10/12/2020 20:24	0,18	0	0,00	CHI
20201256453	CATALAO	TH13028686	CATALAO S1	10/12/2020 14:21	11/12/2020 01:39	10/12/2020 20:14	10/12/2020 20:24	0,18	228	40,60	CHI
20201256453	TRES RANCHOS	TH13028686	CATALAO S1	10/12/2020 14:21	11/12/2020 01:39	10/12/2020 20:14	10/12/2020 20:24	0,18	90	16,03	CHI
20201256453	DISTRITO FEDERAL	TH13028686	CATALAO S1	10/12/2020 14:21	11/12/2020 01:39	10/12/2020 20:14	10/12/2020 20:24	0,18	1	0,18	CHI
20201256453	CATALAO	CT13333667	CATALAO S2	10/12/2020 14:21	11/12/2020 01:39	10/12/2020 22:00	11/12/2020 01:11	3,19	20	63,79	CHI
20201256453	CATALAO	CT12130972	CATALAO S2	10/12/2020 14:21	11/12/2020 01:39	10/12/2020 14:21	11/12/2020 01:39	11,29	27	304,81	CHI
20201256453	CUMARI	CT12130972	CATALAO S2	10/12/2020 14:21	11/12/2020 01:39	10/12/2020 14:21	11/12/2020 01:39	11,29	1	11,29	CHI
20201256079	PLANALTINA	PI12062315	PLANALTINA	10/12/2020 14:24	11/12/2020 22:55	10/12/2020 14:24	11/12/2020 22:55	32,52	3	97,56	CHI
20201256081	GOIANIA	15010170	REAL S2	10/12/2020 14:24	10/12/2020 17:23	10/12/2020 14:24	10/12/2020 17:23	2,97	1	2,97	CHI
20201257057	JARAGUA	70057916	JARAGUA	10/12/2020 14:24	11/12/2020 02:32	10/12/2020 14:24	11/12/2020 02:32	12,13	1	12,13	CHI
20201256198	APARECIDA DE GOIANIA	AP11407202	INDEPENDENCIA S2	10/12/2020 14:26	10/12/2020 17:57	10/12/2020 14:26	10/12/2020 17:57	3,50	48	168,11	CHI
20201257074	GOUVELANDIA	GB12303118	QUIRINOPOLIS	10/12/2020 14:27	11/12/2020 10:10	10/12/2020 14:27	11/12/2020 10:10	19,70	4	78,82	CHI
20201256104	PONTALINA	PK21046002	PONTALINA	10/12/2020 14:29	11/12/2020 10:01	10/12/2020 14:29	11/12/2020 10:01	19,53	1	19,53	CHI
20201256110	GOIANIA	GN11001903	CAMPINAS S1	10/12/2020 14:30	10/12/2020 17:37	10/12/2020 14:30	10/12/2020 17:37	3,11	67	208,28	CHI
20201256118	COLINAS DO SUL	TI21355522	MINACU	10/12/2020 14:31	10/12/2020 19:42	10/12/2020 14:31	10/12/2020 19:42	5,17	1	5,17	CHI
20201256125	PIRENOPOLIS	PV12285272	CORUMBA	10/12/2020 14:32	10/12/2020 18:50	10/12/2020 14:32	10/12/2020 18:50	4,28	8	34,27	CHI
20201256126	SENADOR CANEDO	16112489	SENADOR CANEDO	10/12/2020 14:33	10/12/2020 16:01	10/12/2020 14:33	10/12/2020 16:01	1,45	1	1,45	CHI
20201256133	APARECIDA DE GOIANIA	16400689	ATLANTICO S1	10/12/2020 14:34	10/12/2020 19:39	10/12/2020 14:34	10/12/2020 19:39	5,08	1	5,08	CHI
20201256134	GOIANIA	14515891	CAMPINAS S3	10/12/2020 14:34	10/12/2020 16:29	10/12/2020 14:34	10/12/2020 16:29	1,91	1	1,91	CHI
20201256136	NOVA CRIXAS	10000445361	NOVA CRIXAS	10/12/2020 14:34	11/12/2020 17:27	10/12/2020 14:34	11/12/2020 17:27	26,87	1	26,87	CHI
20201256137	TRINDADE	40248847	GOYA S2	10/12/2020 14:34	10/12/2020 21:34	10/12/2020 14:34	10/12/2020 21:34	6,99	1	6,99	CHI
20201257760	QUIRINOPOLIS	QI12189210	QUIRINOPOLIS	10/12/2020 14:34	11/12/2020 04:54	10/12/2020 14:34	11/12/2020 04:54	14,33	4	57,33	CHI
20201260458	SAO DOMINGOS	GY12330346	SAO DOMINGOS	10/12/2020 14:34	11/12/2020 11:06	10/12/2020 14:34	11/12/2020 11:06	20,52	13	266,80	CHI
20201256168	MONTIVIDIU	MV21295831	MONTIVIDIU T	10/12/2020 14:36	11/12/2020 03:29	10/12/2020 14:36	11/12/2020 03:29	12,87	1	12,87	CHI
20201256169	ITABERAI	GS12183035	ITABERAI S1	10/12/2020 14:36	11/12/2020 13:11	10/12/2020 14:36	11/12/2020 13:11	22,58	2	45,16	CHI
20201256169	GOIAS	GS12183035	ITABERAI S1	10/12/2020 14:36	11/12/2020 13:11	10/12/2020 14:36	11/12/2020 13:11	22,58	1	22,58	CHI
20201256169	GOIAS	GS12183035	ITABERAI S1	10/12/2020 14:36	11/12/2020 13:11	11/12/2020 10:15	11/12/2020 13:11	2,94	15	44,03	CHI
20201256170	RIO VERDE	630104438	RIO VERDE S2	10/12/2020 14:36	10/12/2020 21:02	10/12/2020 14:36	10/12/2020 21:02	6,42	1	6,42	CHI
20201256192	GOIAS	GS12203880	GOIAS	10/12/2020 14:36	10/12/2020 16:28	10/12/2020 14:36	10/12/2020 16:28	1,86	26	48,41	CHI
20201256281	GOIANIA	GN11000696	REAL S2	10/12/2020 14:36	10/12/2020 16:20	10/12/2020 14:36	10/12/2020 16:20	1,73	123	212,38	CHI
20201256299	ANAPOLIS	AN13374436	ANAPOLIS UNIVERSITARIO S1	10/12/2020 14:37	10/12/2020 18:43	10/12/2020 14:37	10/12/2020 18:43	4,11	345	1416,51	CHI
20201256299	ABADIANIA	AN13374436	ANAPOLIS UNIVERSITARIO S1	10/12/2020 14:37	10/12/2020 18:43	10/12/2020 14:37	10/12/2020 18:43	4,11	70	287,41	CHI
20201256177	GOIANIA	GN11244786	FERROVIARIO S1	10/12/2020 14:38	10/12/2020 17:35	10/12/2020 14:38	10/12/2020 17:35	2,95	11	32,50	CHI
20201255098	PIRACANJUBA	PJ10375764	PIRACANJUBA	10/12/2020 14:39	10/12/2020 15:50	10/12/2020 14:39	10/12/2020 15:50	1,18	285	335,35	CHI
20201255098	PROFESSOR JAMIL SAFADY	PJ10375764	PIRACANJUBA	10/12/2020 14:39	10/12/2020 15:50	10/12/2020 14:39	10/12/2020 15:50	1,18	2	2,35	CHI
20201256189	PIRACANJUBA	PJ11171414	PIRACANJUBA	10/12/2020 14:39	10/12/2020 18:26	10/12/2020 14:39	10/12/2020 18:26	3,77	1	3,77	CHI

20201256191	CACU	CC21125815	CACHOEIRA ALTA	10/12/2020 14:40	10/12/2020 19:34	10/12/2020 14:40	10/12/2020 19:34	4,90	1	4,90	CHI
20201256195	VALPARAISO DE GOIAS	2860044869	MARAJOARA	10/12/2020 14:40	10/12/2020 16:23	10/12/2020 14:40	10/12/2020 16:23	1,71	1	1,71	CHI
20201256216	GOIANIA	GN12031153	ATLANTICO S1	10/12/2020 14:42	10/12/2020 18:02	10/12/2020 14:42	10/12/2020 18:02	3,32	216	716,58	CHI
20201256229	AGUAS LINDAS DE GOIAS	10007144120	AGUAS LINDAS DE GOIAS S1	10/12/2020 14:43	10/12/2020 16:26	10/12/2020 14:43	10/12/2020 16:26	1,71	1	1,71	CHI
20201256333	APARECIDA DE GOIANIA	AP11410328	REAL S2	10/12/2020 14:43	10/12/2020 20:42	10/12/2020 14:43	10/12/2020 20:42	5,98	42	251,22	CHI
20201256244	SANTA CRUZ DE GOIAS	BC12012519	PIRES DO RIO S2	10/12/2020 14:45	11/12/2020 00:07	10/12/2020 14:45	11/12/2020 00:07	9,35	2	18,71	CHI
20201256245	MINACU	4020056524	MINACU	10/12/2020 14:46	11/12/2020 21:05	10/12/2020 14:46	11/12/2020 21:05	30,32	1	30,32	CHI
20201256251	PALMEIRAS DE GOIAS	PL12000231	PALMEIRAS	10/12/2020 14:47	10/12/2020 16:32	10/12/2020 14:47	10/12/2020 16:32	1,75	2	3,50	CHI
20201256273	FAINA	MS12220561	ITAPURANGA	10/12/2020 14:47	10/12/2020 17:22	10/12/2020 14:47	10/12/2020 17:22	2,57	10	25,72	CHI
20201256291	PIRES DO RIO	01480414	PIRES DO RIO S2	10/12/2020 14:49	10/12/2020 17:59	10/12/2020 14:51	10/12/2020 16:54	2,04	3	6,13	CHI
20201256291	URUTAI	PR13344683	PIRES DO RIO S2	10/12/2020 14:49	10/12/2020 17:59	10/12/2020 14:51	10/12/2020 17:29	2,64	98	258,64	CHI
20201256291	ORIZONA	PR13344683	PIRES DO RIO S2	10/12/2020 14:49	10/12/2020 17:59	10/12/2020 14:51	10/12/2020 17:29	2,64	8	21,11	CHI
20201256291	PIRES DO RIO	PR13344683	PIRES DO RIO S2	10/12/2020 14:49	10/12/2020 17:59	10/12/2020 14:51	10/12/2020 17:29	2,64	7	18,47	CHI
20201256291	URUTAI	UT13216020	PIRES DO RIO S2	10/12/2020 14:49	10/12/2020 17:59	10/12/2020 14:51	10/12/2020 17:43	2,87	6	17,24	CHI
20201256291	IPAMERI	UT13216020	PIRES DO RIO S2	10/12/2020 14:49	10/12/2020 17:59	10/12/2020 14:51	10/12/2020 17:43	2,87	10	28,73	CHI
20201256291	ORIZONA	UT13216020	PIRES DO RIO S2	10/12/2020 14:49	10/12/2020 17:59	10/12/2020 14:51	10/12/2020 17:43	2,87	1	2,87	CHI
20201256291	IPAMERI	IP13337230	PIRES DO RIO S2	10/12/2020 14:49	10/12/2020 17:59	10/12/2020 14:51	10/12/2020 17:59	3,13	103	322,10	CHI
20201256275	MORRINHOS	MR21385182	MORRINHOS	10/12/2020 14:51	10/12/2020 17:16	10/12/2020 14:51	10/12/2020 17:16	2,41	1	2,41	CHI
20201256295	GUARANI DE GOIAS	SD10401447	SAO DOMINGOS	10/12/2020 14:52	11/12/2020 04:33	10/12/2020 14:52	10/12/2020 16:11	1,30	3	3,91	CHI
20201256295	MONTE ALEGRE DE GOIAS	SD10401447	SAO DOMINGOS	10/12/2020 14:52	11/12/2020 04:33	10/12/2020 14:52	10/12/2020 16:11	1,30	1	1,30	CHI
20201256295	SAO DOMINGOS	SD10401447	SAO DOMINGOS	10/12/2020 14:52	11/12/2020 04:33	10/12/2020 14:52	10/12/2020 16:11	1,30	531	691,63	CHI
20201256295	NOVA ROMA	SD10401447	SAO DOMINGOS	10/12/2020 14:52	11/12/2020 04:33	10/12/2020 14:52	10/12/2020 16:11	1,30	3	3,91	CHI
20201256295	SAO DOMINGOS	SD12104101LD	SAO DOMINGOS	10/12/2020 14:52	11/12/2020 04:33	10/12/2020 14:52	10/12/2020 17:08	2,26	119	269,37	CHI
20201256295	GUARANI DE GOIAS	SD12104101LD	SAO DOMINGOS	10/12/2020 14:52	11/12/2020 04:33	10/12/2020 14:52	10/12/2020 17:08	2,26	5	11,32	CHI
20201256295	MONTE ALEGRE DE GOIAS	SD10401447	SAO DOMINGOS	10/12/2020 14:52	11/12/2020 04:33	10/12/2020 17:15	11/12/2020 03:54	10,65	1	10,65	CHI
20201256295	NOVA ROMA	SD10401447	SAO DOMINGOS	10/12/2020 14:52	11/12/2020 04:33	10/12/2020 17:15	11/12/2020 03:54	10,65	3	31,95	CHI
20201256295	SAO DOMINGOS	SD10401447	SAO DOMINGOS	10/12/2020 14:52	11/12/2020 04:33	10/12/2020 17:15	11/12/2020 03:54	10,65	181	1927,90	CHI
20201256295	SAO DOMINGOS	SD10401447	SAO DOMINGOS	10/12/2020 14:52	11/12/2020 04:33	10/12/2020 17:35	11/12/2020 03:54	10,33	261	2695,91	CHI
20201256295	SAO DOMINGOS	SD12104101LD	SAO DOMINGOS	10/12/2020 14:52	11/12/2020 04:33	10/12/2020 14:52	11/12/2020 04:02	13,16	21	276,42	CHI
20201256295	GUARANI DE GOIAS	SD12104101LD	SAO DOMINGOS	10/12/2020 14:52	11/12/2020 04:33	10/12/2020 14:52	11/12/2020 04:02	13,16	143	1882,28	CHI
20201256295	GUARANI DE GOIAS	SD12104101LD	SAO DOMINGOS	10/12/2020 14:52	11/12/2020 04:33	10/12/2020 17:35	11/12/2020 04:02	10,46	5	52,30	CHI
20201256295	SAO DOMINGOS	SD12104101LD	SAO DOMINGOS	10/12/2020 14:52	11/12/2020 04:33	10/12/2020 17:35	11/12/2020 04:02	10,46	119	1244,84	CHI
20201256295	SAO DOMINGOS	SD12134715LD	SAO DOMINGOS	10/12/2020 14:52	11/12/2020 04:33	10/12/2020 17:35	11/12/2020 04:33	10,97	89	975,96	CHI
20201256295	GUARANI DE GOIAS	SD12134715LD	SAO DOMINGOS	10/12/2020 14:52	11/12/2020 04:33	10/12/2020 17:35	11/12/2020 04:33	10,97	3	32,90	CHI
20201256666	SAO JOAO D ALIANCA	JL12322772	SAO JOAO D ALIANCA	10/12/2020 14:53	10/12/2020 16:58	10/12/2020 14:53	10/12/2020 16:58	2,07	16	33,15	CHI
20201256307	CACU	CC21132700	CACHOEIRA ALTA	10/12/2020 14:56	10/12/2020 21:02	10/12/2020 14:56	10/12/2020 21:02	6,09	1	6,09	CHI
20201256310	APARECIDA DE GOIANIA	15221817	ATLANTICO S2	10/12/2020 14:56	10/12/2020 20:25	10/12/2020 14:56	10/12/2020 20:25	5,47	1	5,47	CHI
20201256317	JARAGUA	JA21015231	ITABERAI S1	10/12/2020 14:57	10/12/2020 18:49	10/12/2020 14:57	10/12/2020 18:49	3,85	1	3,85	CHI
20201256318	GOIANIA	AP11167074	ATLANTICO S2	10/12/2020 14:58	10/12/2020 18:23	10/12/2020 14:58	10/12/2020 18:23	3,42	16	54,67	CHI
20201256338	SAO JOAO D ALIANCA	JL12146226	SAO JOAO D ALIANCA	10/12/2020 15:00	10/12/2020 15:26	10/12/2020 15:00	10/12/2020 15:26	0,42	71	29,90	CHI
20201256339	ACREUNA	2440019635	ACREUNA	10/12/2020 15:01	10/12/2020 18:37	10/12/2020 15:01	10/12/2020 18:37	3,60	1	3,60	CHI
20201256657	SAO LUIS DE MONTES BELOS	SL12373573	SAO LUIZ DOS MONTES BELOS	10/12/2020 15:01	10/12/2020 17:30	10/12/2020 15:01	10/12/2020 17:30	2,48	10	24,82	CHI
20201257900	CALDAZINHA	SV12233221	CEPAIGO S2	10/12/2020 15:01	10/12/2020 23:09	10/12/2020 15:01	10/12/2020 23:09	8,12	4	32,50	CHI
20201256346	PIRENOPOLIS	PV21113056	SAO FRANCISCO DE GOIAS	10/12/2020 15:02	10/12/2020 21:46	10/12/2020 15:02	10/12/2020 21:46	6,72	1	6,72	CHI
20201256435	GOIANIA	GN11003171	AEROPORTO S3	10/12/2020 15:02	10/12/2020 18:33	10/12/2020 15:02	10/12/2020 18:33	3,50	51	178,57	CHI
20201256349	CIDADE OCIDENTAL	10003107548	MARAJOARA	10/12/2020 15:03	10/12/2020 16:47	10/12/2020 15:03	10/12/2020 16:47	1,73	1	1,73	CHI
20201256767	JARAGUA	JA12064321	JARAGUA	10/12/2020 15:04	11/12/2020 17:00	10/12/2020 15:04	11/12/2020 17:00	25,93	4	103,72	CHI
20201256363	CRISTALINA	KR11170474	CRISTALINA S2	10/12/2020 15:05	10/12/2020 17:37	10/12/2020 15:05	10/12/2020 17:37	2,53	1	2,53	CHI
20201256365	ITUMBIARA	IT21305579	ITUMBIARA NOVA	10/12/2020 15:05	10/12/2020 18:30	10/12/2020 15:05	10/12/2020 18:30	3,41	1	3,41	CHI
20201256371	CROMINIA	CQ21017429	PONTALINA	10/12/2020 15:06	11/12/2020 13:56	10/12/2020 15:06	11/12/2020 13:56	22,83	1	22,83	CHI
20201256873	APARECIDA DE GOIANIA	AP12414498	ANHANGUERA	10/12/2020 15:07	10/12/2020 18:10	10/12/2020 15:07	10/12/2020 18:10	3,04	39	118,70	CHI

20201256386	MARA ROSA	MQ21359556	MARA ROSA	10/12/2020 15:08	10/12/2020 17:15	10/12/2020 15:08	10/12/2020 17:15	2,12	1	2,12	CHI
20201256852	PIRACANJUBA	PJ12182883	PIRACANJUBA	10/12/2020 15:09	10/12/2020 17:25	10/12/2020 15:09	10/12/2020 17:25	2,26	189	427,93	CHI
20201256396	GOIANIA	11103796	GOIANIA LESTE S1	10/12/2020 15:10	10/12/2020 17:47	10/12/2020 15:10	10/12/2020 17:47	2,61	1	2,61	CHI
20201256409	AGUA FRIA DE GOIAS	PI12325588	SAO JOAO D ALIANCA	10/12/2020 15:11	11/12/2020 13:43	10/12/2020 15:11	11/12/2020 13:43	22,52	1	22,52	CHI
20201256409	PLANALTINA	PI12325588	SAO JOAO D ALIANCA	10/12/2020 15:11	11/12/2020 13:43	10/12/2020 15:11	11/12/2020 13:43	22,52	102	2297,27	CHI
20201256410	LUZIANIA	LZ11000282	MARAJOARA	10/12/2020 15:11	10/12/2020 16:43	10/12/2020 15:11	10/12/2020 16:43	1,52	90	136,87	CHI
20201256635	APARECIDA DE GOIANIA	AP11166586	REAL S1	10/12/2020 15:11	10/12/2020 19:53	10/12/2020 15:11	10/12/2020 19:53	4,69	77	361,17	CHI
20201256415	IPAMERI	10001554156	IPAMERI	10/12/2020 15:12	11/12/2020 09:02	10/12/2020 15:12	11/12/2020 09:02	17,82	1	17,82	CHI
20201256416	ARAGARCAS	AG21188256	ARAGARCAS	10/12/2020 15:12	10/12/2020 16:37	10/12/2020 15:12	10/12/2020 16:37	1,40	1	1,40	CHI
20201258203	IPAMERI	KR12159932	CRISTALINA S2	10/12/2020 15:12	10/12/2020 22:39	10/12/2020 15:12	10/12/2020 22:39	7,44	11	81,82	CHI
20201256418	GOIANIA	GN11189677	MEIA PONTE	10/12/2020 15:13	10/12/2020 20:08	10/12/2020 15:13	10/12/2020 20:08	4,91	89	436,69	CHI
20201256422	EDEALINA	ED12201550	VICENTINOPOLIS	10/12/2020 15:14	11/12/2020 11:33	10/12/2020 15:14	11/12/2020 11:33	20,32	4	81,26	CHI
20201256426	APARECIDA DO RIO DOCE	AW12189038	CACHOEIRA ALTA	10/12/2020 15:14	12/12/2020 16:25	10/12/2020 15:14	11/12/2020 12:22	21,13	3	63,39	CHI
20201256426	APARECIDA DO RIO DOCE	AW13303788	CACHOEIRA ALTA	10/12/2020 15:14	12/12/2020 16:25	10/12/2020 15:14	12/12/2020 16:25	49,18	18	885,25	CHI
20201256500	PLANALTINA	PI12375541	PLANALTINA	10/12/2020 15:14	10/12/2020 17:42	10/12/2020 15:14	10/12/2020 17:42	2,47	186	459,01	CHI
20201257358	URUTAI	PR12080258RE	URUTAI	10/12/2020 15:15	10/12/2020 20:37	10/12/2020 15:15	10/12/2020 20:37	5,36	23	123,33	CHI
20201256438	JATAI	290151867	JATAI S2	10/12/2020 15:16	11/12/2020 11:58	10/12/2020 15:16	11/12/2020 11:58	20,69	1	20,69	CHI
20201256441	CALDAS NOVAS	PJ12263075	CALDAS NOVAS S1	10/12/2020 15:16	10/12/2020 23:33	10/12/2020 15:16	10/12/2020 23:33	8,27	5	41,37	CHI
20201256445	PONTALINA	PK21283470	VICENTINOPOLIS	10/12/2020 15:17	10/12/2020 21:16	10/12/2020 15:17	10/12/2020 21:16	5,98	2	11,96	CHI
20201256451	TURVANIA	TV12005220	FIRMINOPOLIS S2	10/12/2020 15:18	10/12/2020 16:59	10/12/2020 15:18	10/12/2020 16:59	1,68	9	15,14	CHI
20201256451	PALMEIRAS DE GOIAS	TV12005220	FIRMINOPOLIS S2	10/12/2020 15:18	10/12/2020 16:59	10/12/2020 15:18	10/12/2020 16:59	1,68	5	8,41	CHI
20201256567	SILVANIA	LB12000008	DAIA S2	10/12/2020 15:18	10/12/2020 16:50	10/12/2020 15:18	10/12/2020 16:50	1,52	98	149,40	CHI
20201256567	GAMELEIRA DE GOIAS	LB12000008	DAIA S2	10/12/2020 15:18	10/12/2020 16:50	10/12/2020 15:18	10/12/2020 16:50	1,52	16	24,39	CHI
20201256567	LEOPOLDO DE BULHOES	LB12000008	DAIA S2	10/12/2020 15:18	10/12/2020 16:50	10/12/2020 15:18	10/12/2020 16:50	1,52	161	245,44	CHI
20201256458	GUARANI DE GOIAS	GY21195704	IACIARA S1	10/12/2020 15:19	11/12/2020 01:09	10/12/2020 15:19	11/12/2020 01:09	9,83	2	19,66	CHI
20201256460	JATAI	JT11377834	JATAI S2	10/12/2020 15:19	11/12/2020 10:13	10/12/2020 15:19	11/12/2020 10:13	18,89	1	18,89	CHI
20201256470	GOIANIA	14407670	ATLANTICO S2	10/12/2020 15:22	10/12/2020 17:58	10/12/2020 15:22	10/12/2020 17:58	2,59	1	2,59	CHI
20201256556	FAINA	FC12274421	GOIAS	10/12/2020 15:22	10/12/2020 17:20	10/12/2020 15:22	10/12/2020 17:20	1,95	18	35,14	CHI
20201256475	GOIATUBA	140067450	GOIATUBA S2	10/12/2020 15:23	11/12/2020 20:14	10/12/2020 15:23	11/12/2020 20:14	28,84	1	28,84	CHI
20201256485	AGUA FRIA DE GOIAS	PI21090984	SAO JOAO D ALIANCA	10/12/2020 15:25	10/12/2020 19:32	10/12/2020 15:25	10/12/2020 19:32	4,11	1	4,11	CHI
20201256609	LUZIANIA	LZ11163904	RIO VERMELHO	10/12/2020 15:25	10/12/2020 18:22	10/12/2020 15:25	10/12/2020 18:22	2,93	150	440,17	CHI
20201256795	ARAGOIANIA	AO32021484	GUAPU S2	10/12/2020 15:29	10/12/2020 18:02	10/12/2020 15:29	10/12/2020 18:02	2,54	5	12,69	CHI
20201256513	CIDADE OCIDENTAL	DH11163807	MARAJOARA	10/12/2020 15:30	10/12/2020 19:25	10/12/2020 15:30	10/12/2020 19:25	3,90	175	682,55	CHI
20201257135	URUTAI	UT12375990B	URUTAI	10/12/2020 15:30	10/12/2020 22:17	10/12/2020 15:30	10/12/2020 22:17	6,78	44	298,14	CHI
20201257135	IPAMERI	UT12375990B	URUTAI	10/12/2020 15:30	10/12/2020 22:17	10/12/2020 15:30	10/12/2020 22:17	6,78	29	196,50	CHI
20201256515	QUIRINOPOLIS	QI21257224	QUIRINOPOLIS	10/12/2020 15:31	11/12/2020 00:12	10/12/2020 15:31	11/12/2020 00:12	8,68	6	52,07	CHI
20201256698	PLANALTINA	PI11194814	PLANALTINA	10/12/2020 15:32	10/12/2020 20:02	10/12/2020 15:32	10/12/2020 20:02	4,50	140	629,77	CHI
20201256537	MINEIROS	MY21214303	PARQUE DAS EMAS	10/12/2020 15:36	11/12/2020 12:43	10/12/2020 15:36	11/12/2020 12:43	21,11	1	21,11	CHI
20201256544	CALDAS NOVAS	CN11000012	CALDAS NOVAS S1	10/12/2020 15:37	10/12/2020 23:15	10/12/2020 15:37	10/12/2020 23:15	7,62	121	921,99	CHI
20201256547	PLANALTINA	10001689540	PLANALTINA	10/12/2020 15:38	10/12/2020 16:54	10/12/2020 15:38	10/12/2020 16:54	1,27	1	1,27	CHI
20201256548	PORANGATU	10018959898	PORANGATU	10/12/2020 15:38	10/12/2020 20:43	10/12/2020 15:38	10/12/2020 20:43	5,08	1	5,08	CHI
20201256563	PALMEIRAS DE GOIAS	PL12308411	PALMEIRAS	10/12/2020 15:38	10/12/2020 16:37	10/12/2020 15:38	10/12/2020 16:37	0,98	173	170,02	CHI
20201256564	PILAR DE GOIAS	GG21292659	URUACU	10/12/2020 15:40	11/12/2020 17:21	10/12/2020 15:40	11/12/2020 17:21	25,68	1	25,68	CHI
20201256565	SENADOR CANEDO	SW11379528	CEPAIGO S2	10/12/2020 15:40	10/12/2020 16:56	10/12/2020 15:40	10/12/2020 16:56	1,26	15	18,88	CHI
20201256570	QUIRINOPOLIS	80035115	QUIRINOPOLIS	10/12/2020 15:41	11/12/2020 10:05	10/12/2020 15:41	11/12/2020 10:05	18,39	1	18,39	CHI
20201256571	MAIRIPOTABA	MI12293000	PONTALINA	10/12/2020 15:41	11/12/2020 14:45	10/12/2020 15:41	11/12/2020 14:45	23,06	2	46,12	CHI
20201256575	SAO LUIS DE MONTES BELOS	1190001163	SAO LUIZ DOS MONTES BELOS	10/12/2020 15:41	10/12/2020 21:02	10/12/2020 15:41	10/12/2020 21:02	5,34	1	5,34	CHI
20201256801	PILAR DE GOIAS	GG12181185	SANTA TEREZINHA	10/12/2020 15:41	11/12/2020 03:22	10/12/2020 15:41	11/12/2020 03:22	11,68	27	315,32	CHI
20201256579	CAMPO ALEGRE DE GOIAS	CM21133649	CAMPO ALEGRE DE GOIAS	10/12/2020 15:42	10/12/2020 19:47	10/12/2020 15:42	10/12/2020 19:47	4,08	1	4,08	CHI
20201256584	ALEXANIA	480044533	ALEXANIA	10/12/2020 15:42	11/12/2020 04:12	10/12/2020 15:42	11/12/2020 04:12	12,49	1	12,49	CHI
20201256594	ITABERAI	IB21216488	ITABERAI S2	10/12/2020 15:44	11/12/2020 10:11	10/12/2020 15:44	11/12/2020 10:11	18,44	2	36,88	CHI

20201256596	VICENTINOPOLIS	VI21166493	VICENTINOPOLIS	10/12/2020 15:44	11/12/2020 11:34	10/12/2020 15:44	11/12/2020 11:34	19,82	1	19,82	CHI
20201256602	MINEIROS	MY21301824	PARQUE DAS EMAS	10/12/2020 15:45	11/12/2020 09:07	10/12/2020 15:45	11/12/2020 09:07	17,36	2	34,71	CHI
20201256605	NIQUELANDIA	TI12239430	MINACU	10/12/2020 15:45	12/12/2020 11:54	10/12/2020 15:45	12/12/2020 11:54	44,14	1	44,14	CHI
20201256605	COLINAS DO SUL	TI12239430	MINACU	10/12/2020 15:45	12/12/2020 11:54	10/12/2020 15:45	12/12/2020 11:54	44,14	26	1147,64	CHI
20201256608	SENADOR CANEDO	SW11109009	SENADOR CANEDO	10/12/2020 15:45	10/12/2020 17:24	10/12/2020 15:45	10/12/2020 17:24	1,63	51	83,38	CHI
20201257778	NOVA VENEZA	NV12402751	INHUMAS S1	10/12/2020 15:45	10/12/2020 23:31	10/12/2020 15:45	10/12/2020 23:31	7,77	11	85,43	CHI
20201256617	CAMPOS BELOS	CH12096300	SAO DOMINGOS	10/12/2020 15:47	10/12/2020 17:22	10/12/2020 15:47	10/12/2020 17:22	1,57	162	254,11	CHI
20201256620	TRINDADE	40140799	TRINDADE	10/12/2020 15:48	10/12/2020 17:44	10/12/2020 15:48	10/12/2020 17:44	1,92	1	1,92	CHI
20201256622	FORMOSA	FA31042645	ITUIQUIRA	10/12/2020 15:48	10/12/2020 17:21	10/12/2020 15:48	10/12/2020 17:21	1,55	2	3,09	CHI
20201256633	GOIANIA	10024319161	REAL S1	10/12/2020 15:49	10/12/2020 19:02	10/12/2020 15:49	10/12/2020 19:02	3,20	1	3,20	CHI
20201256640	PIRES DO RIO	PR21154622	PIRES DO RIO S1	10/12/2020 15:50	10/12/2020 18:21	10/12/2020 15:50	10/12/2020 18:21	2,50	1	2,50	CHI
20201257828	POSSE	PS12235404	IACIARA S2	10/12/2020 15:50	11/12/2020 01:32	10/12/2020 15:50	11/12/2020 01:32	9,69	32	310,00	CHI
20201256645	SAO JOAO D ALIANCA	JL21255803	SAO JOAO D ALIANCA	10/12/2020 15:51	12/12/2020 12:07	10/12/2020 15:51	12/12/2020 12:07	44,26	2	88,51	CHI
20201256652	ALEXANIA	AX21236666	ALEXANIA	10/12/2020 15:52	10/12/2020 23:29	10/12/2020 15:52	10/12/2020 23:29	7,61	1	7,61	CHI
20201256655	PLANALTINA	6795969	PLANALTINA	10/12/2020 15:52	11/12/2020 01:47	10/12/2020 15:52	11/12/2020 01:47	9,91	31	307,21	CHI
20201256838	SAO MIGUEL DO ARAGUAIA	SM12292369	SAO MIGUEL DO ARAGUAIA	10/12/2020 15:54	10/12/2020 23:46	10/12/2020 15:54	10/12/2020 23:46	7,87	75	589,90	CHI
20201256855	RUBIATABA	RB12201363	RUBIATABA	10/12/2020 15:55	11/12/2020 06:56	10/12/2020 15:55	11/12/2020 06:56	15,01	11	165,07	CHI
20201256671	ACREUNA	2440057582	ACREUNA	10/12/2020 15:56	10/12/2020 21:02	10/12/2020 15:56	10/12/2020 21:02	5,09	1	5,09	CHI
20201256673	PALMEIRAS DE GOIAS	PL21124668	PALMEIRAS	10/12/2020 15:56	10/12/2020 17:26	10/12/2020 15:56	10/12/2020 17:26	1,49	1	1,49	CHI
20201256700	NOVA CRIXAS	NA21121188	NOVA CRIXAS	10/12/2020 15:57	11/12/2020 13:46	10/12/2020 15:57	11/12/2020 13:46	21,81	1	21,81	CHI
20201256708	ITAUCU	IX21148254	INHUMAS S1	10/12/2020 15:58	10/12/2020 21:22	10/12/2020 15:58	10/12/2020 21:22	5,40	1	5,40	CHI
20201256709	MAIRIPOTABA	MI21023195	PONTALINA	10/12/2020 15:58	11/12/2020 20:22	10/12/2020 15:58	11/12/2020 20:22	28,39	2	56,79	CHI
20201256718	CRISTIANOPOLIS	CF11217008	CRISTIANOPOLIS	10/12/2020 16:00	10/12/2020 20:42	10/12/2020 16:00	10/12/2020 20:42	4,70	89	417,95	CHI
20201256727	GOIANIA	11087328	GOIANIA LESTE S2	10/12/2020 16:01	10/12/2020 17:57	10/12/2020 16:01	10/12/2020 17:57	1,92	1	1,92	CHI
20201256992	SAO MIGUEL DO ARAGUAIA	SM12143671	SAO MIGUEL DO ARAGUAIA	10/12/2020 16:01	10/12/2020 17:41	10/12/2020 16:01	10/12/2020 17:41	1,66	276	458,70	CHI
20201256914	PLANALTINA	PI12063560	PLANALTINA	10/12/2020 16:02	11/12/2020 04:40	10/12/2020 16:02	11/12/2020 04:40	12,62	15	189,32	CHI
20201256737	ANAPOLIS	10028850937	ANAPOLIS UNIVERSITARIO S1	10/12/2020 16:03	10/12/2020 16:49	10/12/2020 16:03	10/12/2020 16:49	0,75	1	0,75	CHI
20201256740	RIO VERDE	RV11256061	RIO VERDE S1	10/12/2020 16:04	10/12/2020 23:01	10/12/2020 19:18	10/12/2020 22:48	3,50	92	322,10	CHI
20201256740	RIO VERDE	RV13338639	RIO VERDE S1	10/12/2020 16:04	10/12/2020 23:01	10/12/2020 19:18	10/12/2020 23:01	3,71	516	1915,94	CHI
20201256809	DOVERLANDIA	DV12223236	CAIAPONIA	10/12/2020 16:04	10/12/2020 18:00	10/12/2020 16:04	10/12/2020 18:00	1,92	15	28,85	CHI
20201256741	HIDROLINA	HL21144986	URUACU	10/12/2020 16:05	11/12/2020 15:14	10/12/2020 16:05	11/12/2020 15:14	23,15	1	23,15	CHI
20201256756	FLORES DE GOIAS	FB11255063	FLORES DE GOIAS	10/12/2020 16:07	11/12/2020 16:21	10/12/2020 16:07	11/12/2020 16:21	24,23	18	436,12	CHI
20201256759	TURVELANDIA	SH31222605	IPEGUARI	10/12/2020 16:07	11/12/2020 01:12	10/12/2020 16:07	11/12/2020 01:12	9,07	1	9,07	CHI
20201257195	SANTO ANTONIO DA BARRA	BZ12048964	ACREUNA	10/12/2020 16:07	10/12/2020 19:17	10/12/2020 16:07	10/12/2020 19:17	3,17	39	123,56	CHI
20201257195	RIO VERDE	BZ12048964	ACREUNA	10/12/2020 16:07	10/12/2020 19:17	10/12/2020 16:07	10/12/2020 19:17	3,17	42	133,07	CHI
20201257542	APARECIDA DE GOIANIA	AP11000073	CEPAIGO S1	10/12/2020 16:07	10/12/2020 20:13	10/12/2020 16:07	10/12/2020 20:13	4,10	60	245,97	CHI
20201256763	RIO VERDE	RV12213287	CABRIUVA S1	10/12/2020 16:08	10/12/2020 20:51	10/12/2020 16:08	10/12/2020 20:51	4,71	184	867,00	CHI
20201257011	JUSSARA	NB12117282	JUSSARA	10/12/2020 16:08	10/12/2020 19:28	10/12/2020 16:08	10/12/2020 19:28	3,33	1	3,33	CHI
20201257011	NOVO BRASIL	NB12117282	JUSSARA	10/12/2020 16:08	10/12/2020 19:28	10/12/2020 16:08	10/12/2020 19:28	3,33	12	39,90	CHI
20201257011	FAZENDA NOVA	NB12117282	JUSSARA	10/12/2020 16:08	10/12/2020 19:28	10/12/2020 16:08	10/12/2020 19:28	3,33	1	3,33	CHI
20201256780	QUIRINOPOLIS	QI21126448	QUIRINOPOLIS	10/12/2020 16:10	11/12/2020 10:59	10/12/2020 16:10	11/12/2020 10:59	18,82	1	18,82	CHI
20201256781	JAUPACI	JP21154784	IPORA	10/12/2020 16:10	11/12/2020 10:23	10/12/2020 16:10	11/12/2020 10:23	18,21	1	18,21	CHI
20201257128	GOIANIA	GN11251449	CARAJAS S1	10/12/2020 16:10	10/12/2020 18:02	10/12/2020 16:10	10/12/2020 18:02	1,86	129	239,87	CHI
20201256791	SAO MIGUEL DO ARAGUAIA	SM12086469	SAO MIGUEL DO ARAGUAIA	10/12/2020 16:11	10/12/2020 21:59	10/12/2020 16:11	10/12/2020 21:59	5,80	486	2818,66	CHI
20201257299	CATALAO	CT12306664	CATALAO S1	10/12/2020 16:11	10/12/2020 18:54	10/12/2020 16:11	10/12/2020 18:54	2,71	4	10,85	CHI
20201257299	OUIDOR	CT12306664	CATALAO S1	10/12/2020 16:11	10/12/2020 18:54	10/12/2020 16:11	10/12/2020 18:54	2,71	2	5,43	CHI
20201256793	GOIANIA	11335737	GOIANIA LESTE S2	10/12/2020 16:12	10/12/2020 17:30	10/12/2020 16:12	10/12/2020 17:30	1,29	1	1,29	CHI
20201256794	AMORINOPOLIS	AM21039410	IPORA	10/12/2020 16:12	10/12/2020 17:19	10/12/2020 16:12	10/12/2020 17:19	1,11	1	1,11	CHI
20201256796	CABECEIRAS	CW11046860	ITUIQUIRA	10/12/2020 16:12	10/12/2020 19:24	10/12/2020 16:12	10/12/2020 19:24	3,18	146	465,01	CHI
20201256803	COCALZINHO DE GOIAS	ZN12104981	AGUAS LINDAS DE GOIAS S2	10/12/2020 16:13	10/12/2020 20:39	10/12/2020 16:13	10/12/2020 20:39	4,42	3	13,26	CHI
20201256804	NAZARIO	440022150	ANICUNS	10/12/2020 16:13	10/12/2020 18:23	10/12/2020 16:13	10/12/2020 18:23	2,15	1	2,15	CHI

20201256907	FAZENDA NOVA	FN12390148	IPORA	10/12/2020 16:13	10/12/2020 20:43	10/12/2020 16:13	10/12/2020 20:43	4,50	3	13,50	CHI
20201256907	ISRAELANDIA	FN12390148	IPORA	10/12/2020 16:13	10/12/2020 20:43	10/12/2020 16:13	10/12/2020 20:43	4,50	11	49,50	CHI
20201256810	ANAPOLIS	10031629499	ANAPOLIS UNIVERSITARIO S2	10/12/2020 16:14	10/12/2020 21:43	10/12/2020 16:14	10/12/2020 21:43	5,48	1	5,48	CHI
20201256815	NIQUELANDIA	NQ21237322	URUACU	10/12/2020 16:15	11/12/2020 07:51	10/12/2020 16:15	11/12/2020 07:51	15,59	20	311,80	CHI
20201256851	PLANALTINA	PI21344223	PLANALTINA	10/12/2020 16:20	11/12/2020 08:56	10/12/2020 16:20	11/12/2020 08:56	16,59	1	16,59	CHI
20201256979	NOVO BRASIL	NB11020195	JUSSARA	10/12/2020 16:22	10/12/2020 17:30	10/12/2020 16:22	10/12/2020 17:30	1,14	128	145,53	CHI
20201257584	TAQUARAL DE GOIAS	TQ12250793	ITABERAI S1	10/12/2020 16:22	11/12/2020 23:37	10/12/2020 16:22	11/12/2020 23:37	31,26	11	343,85	CHI
20201256866	CRISTALINA	KR12313552	CRISTALINA S2	10/12/2020 16:23	10/12/2020 21:48	10/12/2020 16:23	10/12/2020 21:48	5,41	28	151,49	CHI
20201256867	CACU	CC12021384	CACHOEIRA ALTA	10/12/2020 16:23	11/12/2020 14:48	10/12/2020 16:23	11/12/2020 14:48	22,41	12	268,92	CHI
20201256878	APORE	AE21296571	ITAJA S2	10/12/2020 16:24	10/12/2020 23:53	10/12/2020 16:24	10/12/2020 23:53	7,47	1	7,47	CHI
20201256879	RIO VERDE	RV12034867	CABRIUVA S2	10/12/2020 16:24	11/12/2020 00:45	10/12/2020 16:24	11/12/2020 00:45	8,34	1	8,34	CHI
20201257272	URUACU	UR12374572	URUACU	10/12/2020 16:24	11/12/2020 01:26	10/12/2020 16:24	11/12/2020 01:26	9,03	6	54,17	CHI
20201257272	HIDROLINA	UR12374572	URUACU	10/12/2020 16:24	11/12/2020 01:26	10/12/2020 16:24	11/12/2020 01:26	9,03	2	18,06	CHI
20201256883	PIRACANJUBA	PJ21084856	PIRACANJUBA	10/12/2020 16:25	11/12/2020 07:08	10/12/2020 16:25	11/12/2020 07:08	14,71	2	29,43	CHI
20201256888	TAQUARAL DE GOIAS	TQ21059743	ITABERAI S1	10/12/2020 16:25	11/12/2020 13:23	10/12/2020 16:25	11/12/2020 13:23	20,95	1	20,95	CHI
20201256916	RIO VERDE	RV12207146	MONTIVIDIU T	10/12/2020 16:25	10/12/2020 21:00	10/12/2020 16:25	10/12/2020 21:00	4,57	9	41,15	CHI
20201256894	MINEIROS	MY21337074	PARQUE DAS EMAS	10/12/2020 16:26	11/12/2020 13:36	10/12/2020 16:26	11/12/2020 13:36	21,16	1	21,16	CHI
20201257846	NIQUELANDIA	NQ12056787RE	URUACU	10/12/2020 16:26	11/12/2020 01:24	10/12/2020 16:26	11/12/2020 01:24	8,96	76	681,17	CHI
20201256912	CACU	CC21360653	CACHOEIRA ALTA	10/12/2020 16:28	11/12/2020 13:43	10/12/2020 16:28	11/12/2020 13:43	21,24	1	21,24	CHI
20201257182	CAMPO ALEGRE DE GOIAS	CM12203167	CAMPO ALEGRE DE GOIAS	10/12/2020 16:28	10/12/2020 20:31	10/12/2020 16:28	10/12/2020 20:31	4,03	11	44,37	CHI
20201257434	CAIAPONIA	CP12267742	MONTIVIDIU T	10/12/2020 16:28	11/12/2020 00:32	10/12/2020 16:28	11/12/2020 00:32	8,07	1	8,07	CHI
20201257434	MONTIVIDIU	CP12267742	MONTIVIDIU T	10/12/2020 16:28	11/12/2020 00:32	10/12/2020 16:28	11/12/2020 00:32	8,07	1	8,07	CHI
20201256980	TRINDADE	TR12036568	TRINDADE	10/12/2020 16:30	10/12/2020 19:48	10/12/2020 16:30	10/12/2020 19:48	3,29	7	23,01	CHI
20201257035	MONTE ALEGRE DE GOIAS	MA12383372	SAO DOMINGOS	10/12/2020 16:30	10/12/2020 17:26	10/12/2020 16:30	10/12/2020 17:26	0,93	4	3,73	CHI
20201256940	JARAGUA	JA21354178	SAO FRANCISCO DE GOIAS	10/12/2020 16:31	11/12/2020 08:21	10/12/2020 16:31	11/12/2020 08:21	15,82	1	15,82	CHI
20201256941	CAMPO LIMPO	960011298	NEROPOLIS S1	10/12/2020 16:31	10/12/2020 21:19	10/12/2020 16:31	10/12/2020 21:19	4,78	1	4,78	CHI
20201256950	GOIANIA	12003566	CAMPINAS S1	10/12/2020 16:33	10/12/2020 18:43	10/12/2020 16:33	10/12/2020 18:43	2,16	1	2,16	CHI
20201257352	PORANGATU	PO12390476	MARA ROSA	10/12/2020 16:33	10/12/2020 20:53	10/12/2020 16:33	10/12/2020 20:53	4,33	48	207,69	CHI
20201256966	CAMPINORTE	CR11333960	CAMPINORTE	10/12/2020 16:36	10/12/2020 20:00	10/12/2020 16:36	10/12/2020 20:00	3,40	44	149,60	CHI
20201257445	SAO MIGUEL DO ARAGUAIA	SM12031421	SAO MIGUEL DO ARAGUAIA	10/12/2020 16:36	10/12/2020 23:19	10/12/2020 16:36	10/12/2020 23:19	6,72	17	114,16	CHI
20201257129	BOM JARDIM DE GOIAS	BM12334813	IPORA	10/12/2020 16:38	10/12/2020 21:54	10/12/2020 16:38	10/12/2020 21:54	5,26	15	78,96	CHI
20201257292	MINEIROS	MY11182127	PARQUE DAS EMAS	10/12/2020 16:38	11/12/2020 21:05	10/12/2020 16:38	10/12/2020 21:05	4,44	96	426,35	CHI
20201256995	SAO JOAO D ALIANCA	JL31198426	SAO JOAO D ALIANCA	10/12/2020 16:40	11/12/2020 10:03	10/12/2020 16:40	11/12/2020 10:03	17,37	1	17,37	CHI
20201257934	GOIATUBA	GT12044869	GOIATUBA S2	10/12/2020 16:40	10/12/2020 21:41	10/12/2020 16:40	10/12/2020 21:41	5,01	5	25,07	CHI
20201256997	SANTO ANTONIO DO DESCOBERTO	2210185240	AGUAS LINDAS DE GOIAS S2	10/12/2020 16:41	10/12/2020 21:21	10/12/2020 16:41	10/12/2020 21:21	4,66	1	4,66	CHI
20201256998	NIQUELANDIA	NQ21236452	URUACU	10/12/2020 16:41	11/12/2020 03:49	10/12/2020 16:41	11/12/2020 03:49	11,12	1	11,12	CHI
20201257005	CAMPO ALEGRE DE GOIAS	CM12250229	CAMPO ALEGRE DE GOIAS	10/12/2020 16:42	11/12/2020 09:04	10/12/2020 16:42	11/12/2020 09:04	16,35	4	65,42	CHI
20201257007	PLANALTINA	PI21248247	SAO JOAO D ALIANCA	10/12/2020 16:42	11/12/2020 22:04	10/12/2020 16:42	11/12/2020 22:04	29,35	1	29,35	CHI
20201258247	MONTES CLAROS DE GOIAS	ME12204903	IPORA	10/12/2020 16:42	11/12/2020 08:34	10/12/2020 16:42	11/12/2020 08:34	15,86	3	47,58	CHI
20201257008	GOIANIA	14619349	CAMPINAS S1	10/12/2020 16:43	10/12/2020 21:16	10/12/2020 16:43	10/12/2020 21:16	4,55	1	4,55	CHI
20201257009	GOIANIA	11335464	GOYA S1	10/12/2020 16:43	10/12/2020 19:34	10/12/2020 16:43	10/12/2020 19:34	2,85	1	2,85	CHI
20201257014	MINEIROS	MY21195603	PARQUE DAS EMAS	10/12/2020 16:43	11/12/2020 11:45	10/12/2020 16:43	11/12/2020 11:45	19,03	1	19,03	CHI
20201257302	GAMELEIRA DE GOIAS	SV12027617	DAIA S2	10/12/2020 16:44	10/12/2020 18:52	10/12/2020 16:44	10/12/2020 18:52	2,12	22	46,70	CHI
20201257020	MAIRIPOTABA	CQ12000225	PONTALINA	10/12/2020 16:45	11/12/2020 15:40	10/12/2020 16:45	11/12/2020 15:40	22,90	1	22,90	CHI
20201257066	ANAPOLIS	AN12004481	NEROPOLIS S1	10/12/2020 16:45	10/12/2020 19:24	10/12/2020 16:45	10/12/2020 19:24	2,64	8	21,11	CHI
20201257024	NOVO BRASIL	NB21165484	JUSSARA	10/12/2020 16:46	10/12/2020 19:30	10/12/2020 16:46	10/12/2020 19:30	2,72	1	2,72	CHI
20201257030	VILA PROPICIO	NP12231823	GOIANESIA S1	10/12/2020 16:47	11/12/2020 10:33	10/12/2020 16:47	11/12/2020 10:33	17,75	18	319,52	CHI
20201257042	LUZIANIA	10000129524	RIO VERMELHO	10/12/2020 16:49	10/12/2020 21:15	10/12/2020 16:49	10/12/2020 21:15	4,43	1	4,43	CHI
20201257047	ITARUMA	IM21041678	CACHOEIRA ALTA	10/12/2020 16:51	11/12/2020 02:56	10/12/2020 16:51	11/12/2020 02:56	10,08	2	20,16	CHI
20201257054	NIQUELANDIA	NQ21117735	BARRO ALTO	10/12/2020 16:51	11/12/2020 10:08	10/12/2020 16:51	11/12/2020 10:08	17,27	1	17,27	CHI
20201257685	FLORES DE GOIAS	FB12085509	FLORES DE GOIAS	10/12/2020 16:51	11/12/2020 09:38	10/12/2020 16:51	11/12/2020 09:38	16,78	7	117,43	CHI

20201257060	SANTA RITA DO NOVO DESTINO	BA12373973	BARRO ALTO	10/12/2020 16:52	10/12/2020 19:18	10/12/2020 16:52	10/12/2020 19:18	2,42	3	7,27	CHI
20201257070	INDIARA	2710030890	EDEIA	10/12/2020 16:53	10/12/2020 19:33	10/12/2020 16:53	10/12/2020 19:33	2,65	1	2,65	CHI
20201257077	MONTES CLAROS DE GOIAS	ME12088929	IPORA	10/12/2020 16:54	10/12/2020 19:53	10/12/2020 16:54	10/12/2020 19:53	2,97	2	5,93	CHI
20201257078	APORE	AE21216594	ITAJA S1	10/12/2020 16:55	10/12/2020 19:49	10/12/2020 16:55	10/12/2020 19:49	2,90	1	2,90	CHI
20201257085	FORMOSA	610030700	ITUIQUIRA	10/12/2020 16:55	10/12/2020 23:08	10/12/2020 16:55	10/12/2020 23:08	6,20	1	6,20	CHI
20201257123	HIDROLINA	UR12374716	URUACU	10/12/2020 16:55	12/12/2020 16:16	10/12/2020 16:55	12/12/2020 16:16	47,35	9	426,12	CHI
20201257092	PIRACANJUBA	PJ12257906	PIRACANJUBA	10/12/2020 16:57	11/12/2020 19:01	10/12/2020 16:57	11/12/2020 19:01	26,06	4	104,25	CHI
20201257747	ARUANA	AK12341206	BRITANIA	10/12/2020 16:59	10/12/2020 19:39	10/12/2020 16:59	10/12/2020 19:39	2,66	6	15,98	CHI
20201257108	APARECIDA DE GOIANIA	15460253	REAL S1	10/12/2020 17:00	10/12/2020 18:24	10/12/2020 17:00	10/12/2020 18:24	1,40	1	1,40	CHI
20201257110	GOIANIA	10004527141	CAMPINAS S2	10/12/2020 17:00	10/12/2020 21:29	10/12/2020 17:00	10/12/2020 21:29	4,48	1	4,48	CHI
20201257113	RIO VERDE	RV12023964	CABRIUVA S2	10/12/2020 17:01	10/12/2020 20:40	10/12/2020 17:01	10/12/2020 20:40	3,64	2	7,28	CHI
20201257121	PADRE BERNARDO	PB12284769	PADRE BERNARDO	10/12/2020 17:02	10/12/2020 19:10	10/12/2020 17:02	10/12/2020 19:10	2,12	69	146,61	CHI
20201257144	APARECIDA DE GOIANIA	200636364	ANHANGUERA	10/12/2020 17:05	10/12/2020 22:07	10/12/2020 17:05	10/12/2020 22:07	5,02	1	5,02	CHI
20201257668	APARECIDA DE GOIANIA	AP11291372	INDEPENDENCIA S1	10/12/2020 17:05	10/12/2020 20:03	10/12/2020 17:05	10/12/2020 20:03	2,96	148	437,75	CHI
20201257150	ITABERAÍ	10016992472	ITABERAÍ S2	10/12/2020 17:07	10/12/2020 19:49	10/12/2020 17:07	10/12/2020 19:49	2,69	1	2,69	CHI
20201257151	RIO VERDE	RV12402439	CABRIUVA S1	10/12/2020 17:07	10/12/2020 22:42	10/12/2020 17:07	10/12/2020 22:42	5,58	2	11,15	CHI
20201257154	BELA VISTA DE GOIAS	BV31058276	BELA VISTA S1	10/12/2020 17:09	10/12/2020 21:29	10/12/2020 17:09	10/12/2020 21:29	4,33	2	8,66	CHI
20201257159	EDEIA	EA21108368	EDEIA	10/12/2020 17:09	11/12/2020 10:42	10/12/2020 17:09	11/12/2020 10:42	17,54	1	17,54	CHI
20201257608	APARECIDA DE GOIANIA	AP12128096	INDEPENDENCIA S1	10/12/2020 17:09	10/12/2020 19:49	10/12/2020 17:09	10/12/2020 19:49	2,66	223	593,24	CHI
20201257160	MIMOSO DE GOIAS	3170001770	PADRE BERNARDO	10/12/2020 17:10	10/12/2020 18:27	10/12/2020 17:10	10/12/2020 18:27	1,28	1	1,28	CHI
20201257162	GOIANIA	10001279660	ATLANTICO S2	10/12/2020 17:10	10/12/2020 19:33	10/12/2020 17:10	10/12/2020 19:33	2,37	1	2,37	CHI
20201257163	ANAPOLIS	20097281	JUNDIAI S2	10/12/2020 17:11	10/12/2020 20:01	10/12/2020 17:11	10/12/2020 20:01	2,85	1	2,85	CHI
20201257167	SANTA CRUZ DE GOIAS	CF12103816	CRISTIANOPOLIS	10/12/2020 17:11	10/12/2020 23:28	10/12/2020 17:11	10/12/2020 23:28	6,27	11	68,96	CHI
20201257169	BOM JESUS DE GOIAS	BJ21310054	BOM JESUS DE GOIAS	10/12/2020 17:12	11/12/2020 00:11	10/12/2020 17:12	11/12/2020 00:11	6,98	1	6,98	CHI
20201257170	TRINDADE	11894441	GOYA S1	10/12/2020 17:12	10/12/2020 21:23	10/12/2020 17:12	10/12/2020 21:23	4,17	1	4,17	CHI
20201257238	FORMOSA	FA12146108	ITUIQUIRA	10/12/2020 17:12	10/12/2020 19:44	10/12/2020 17:12	10/12/2020 19:44	2,52	33	83,15	CHI
20201257175	NOVO GAMA	2460018168	PACAEMBU S1	10/12/2020 17:13	10/12/2020 19:06	10/12/2020 17:13	10/12/2020 19:06	1,88	1	1,88	CHI
20201257349	APARECIDA DE GOIANIA	AP11158615	REAL S1	10/12/2020 17:13	10/12/2020 22:52	10/12/2020 17:13	10/12/2020 22:52	5,64	81	456,95	CHI
20201257357	ORIZONA	OZ10400412	PIRES DO RIO S2	10/12/2020 17:13	12/12/2020 10:15	12/12/2020 10:04	12/12/2020 10:15	0,18	39	6,91	CHI
20201257357	ORIZONA	OZ12207629LD	PIRES DO RIO S2	10/12/2020 17:13	12/12/2020 10:15	10/12/2020 17:13	12/12/2020 10:15	41,05	332	13627,03	CHI
20201257357	LUZIANIA	OZ12207629LD	PIRES DO RIO S2	10/12/2020 17:13	12/12/2020 10:15	10/12/2020 17:13	12/12/2020 10:15	41,05	2	82,09	CHI
20201257183	CACHOEIRA ALTA	CA12360864	CACHOEIRA ALTA	10/12/2020 17:15	10/12/2020 19:37	10/12/2020 17:15	10/12/2020 19:37	2,37	1	2,37	CHI
20201257185	PIRACANJUBA	PJ21148086	CALDAS NOVAS S1	10/12/2020 17:15	10/12/2020 18:02	10/12/2020 17:15	10/12/2020 18:02	0,77	1	0,77	CHI
20201257436	SENADOR CANEDO	SW11188919	SENADOR CANEDO	10/12/2020 17:15	10/12/2020 20:28	10/12/2020 17:15	10/12/2020 20:28	3,21	137	439,20	CHI
20201257189	RIO VERDE	RV21346065	RIO VERDE S2	10/12/2020 17:16	10/12/2020 18:51	10/12/2020 17:16	10/12/2020 18:51	1,58	1	1,58	CHI
20201257190	INHUMAS	IN21027498	INHUMAS S1	10/12/2020 17:16	10/12/2020 23:20	10/12/2020 17:16	10/12/2020 23:20	6,06	2	12,13	CHI
20201257246	MONTIVÍDIU	MV12267614B	MONTIVÍDIU T	10/12/2020 17:18	12/12/2020 07:17	10/12/2020 17:18	11/12/2020 17:58	24,67	11	271,37	CHI
20201257246	MONTIVÍDIU	MV12267614B	MONTIVÍDIU T	10/12/2020 17:18	12/12/2020 07:17	10/12/2020 17:18	12/12/2020 07:17	37,98	8	303,85	CHI
20201257946	RIO VERDE	RV11371409	CABRIUVA S1	10/12/2020 17:19	11/12/2020 00:04	10/12/2020 17:19	11/12/2020 00:04	6,74	47	316,90	CHI
20201257208	PARAUNA	PU21228083	PARAUNA	10/12/2020 17:20	11/12/2020 07:40	10/12/2020 17:20	11/12/2020 07:40	14,33	1	14,33	CHI
20201257209	APARECIDA DE GOIANIA	10005317850	ANHANGUERA	10/12/2020 17:20	11/12/2020 00:36	10/12/2020 17:20	11/12/2020 00:36	7,26	1	7,26	CHI
20201257210	NIQUELANDIA	NQ12268729	BARRO ALTO	10/12/2020 17:20	10/12/2020 21:26	10/12/2020 17:20	10/12/2020 21:26	4,10	63	258,00	CHI
20201257216	SAO LUIS DE MONTES BELOS	SL31072432	FIRMINOPOLIS S1	10/12/2020 17:21	10/12/2020 19:17	10/12/2020 17:21	10/12/2020 19:17	1,93	1	1,93	CHI
20201257217	PADRE BERNARDO	PB12162859	PADRE BERNARDO	10/12/2020 17:21	10/12/2020 20:54	10/12/2020 17:21	10/12/2020 20:54	3,54	1	3,54	CHI
20201257219	ANAPOLIS	AN12118517	DAIA S2	10/12/2020 17:22	11/12/2020 06:32	10/12/2020 17:22	11/12/2020 06:32	13,17	4	52,69	CHI
20201257404	ARENOPOLIS	AY11193291	ARENOPOLIS	10/12/2020 17:22	10/12/2020 21:45	10/12/2020 17:22	10/12/2020 21:45	4,37	69	301,49	CHI
20201257231	ARUANA	AK21220028	BRITANIA	10/12/2020 17:24	10/12/2020 18:43	10/12/2020 17:24	10/12/2020 18:43	1,31	1	1,31	CHI
20201257378	IPAMERI	IP12200146	URUTAI	10/12/2020 17:25	11/12/2020 09:39	10/12/2020 17:25	11/12/2020 09:39	16,23	4	64,92	CHI
20201257260	CATALAO	CT11358410	CATALAO S2	10/12/2020 17:27	10/12/2020 19:14	10/12/2020 17:27	10/12/2020 19:14	1,78	58	103,35	CHI
20201257264	GOIANIA	12061165	GOYA S1	10/12/2020 17:32	10/12/2020 22:19	10/12/2020 17:32	10/12/2020 22:19	4,77	1	4,77	CHI
20201257433	APARECIDA DE GOIANIA	AP11383827	ANHANGUERA	10/12/2020 17:32	10/12/2020 18:59	10/12/2020 17:32	10/12/2020 18:59	1,45	68	98,32	CHI

20201257265	GOIANIA	10015390541	XAVANTES	10/12/2020 17:33	10/12/2020 23:26	10/12/2020 17:33	10/12/2020 23:26	5,88	1	5,88	CHI
20201257268	NOVA CRIXAS	NA12091693	NOVA CRIXAS	10/12/2020 17:33	11/12/2020 00:52	10/12/2020 17:33	11/12/2020 00:52	7,31	2	14,61	CHI
20201257270	SAO JOAO D ALIANCA	10000323614	SAO JOAO D ALIANCA	10/12/2020 17:33	11/12/2020 13:51	10/12/2020 17:33	11/12/2020 13:51	20,29	1	20,29	CHI
20201257335	MINEIROS	MY12244782	PARQUE DAS EMAS	10/12/2020 17:33	11/12/2020 11:33	10/12/2020 17:33	11/12/2020 11:33	17,99	6	107,95	CHI
20201257271	GOIANIA	GN11150501	GOYA S2	10/12/2020 17:34	10/12/2020 23:48	10/12/2020 17:34	10/12/2020 23:48	6,23	179	1114,52	CHI
20201257273	RIO VERDE	RV21160771	RIO VERDE S1	10/12/2020 17:34	10/12/2020 22:46	10/12/2020 17:34	10/12/2020 22:46	5,19	1	5,19	CHI
20201257276	CATALAO	CT21152868	IPAMERI	10/12/2020 17:35	11/12/2020 11:16	10/12/2020 17:35	11/12/2020 11:16	17,68	1	17,68	CHI
20201257363	QUIRINOPOLIS	QI32052457	QUIRINOPOLIS	10/12/2020 17:35	10/12/2020 22:05	10/12/2020 17:35	10/12/2020 22:05	4,49	9	40,42	CHI
20201257283	SERRANOPOLIS	SX21318791	ITAJA S1	10/12/2020 17:36	11/12/2020 21:26	10/12/2020 17:36	11/12/2020 21:26	27,83	1	27,83	CHI
20201257287	GOIANIA	12097810	GOYA S1	10/12/2020 17:37	11/12/2020 00:06	10/12/2020 17:37	11/12/2020 00:06	6,47	1	6,47	CHI
20201257337	PLANALTINA	PI12099511	PLANALTINA	10/12/2020 17:39	11/12/2020 02:46	10/12/2020 17:39	11/12/2020 02:46	9,10	17	154,73	CHI
20201257306	GOIANIA	10304174	CAMPINAS S2	10/12/2020 17:42	11/12/2020 01:07	10/12/2020 17:42	11/12/2020 01:07	7,41	1	7,41	CHI
20201257526	MAMBAI	MB12140432	IACIARA S2	10/12/2020 17:43	10/12/2020 20:38	10/12/2020 17:43	10/12/2020 20:38	2,91	17	49,50	CHI
20201257318	PIRACANJUBA	PJ21000146	PIRACANJUBA	10/12/2020 17:44	11/12/2020 01:55	10/12/2020 17:44	11/12/2020 01:55	8,18	1	8,18	CHI
20201257487	MORRINHOS	MR12172969	MORRINHOS	10/12/2020 17:44	10/12/2020 20:28	10/12/2020 17:44	10/12/2020 20:28	2,72	200	544,39	CHI
20201257338	PETROLINA DE GOIAS	PG21071671	PETROLINA	10/12/2020 17:47	11/12/2020 01:51	10/12/2020 17:47	11/12/2020 01:51	8,06	2	16,12	CHI
20201257340	GOIANIA	GN11000852	FERROVIARIO S2	10/12/2020 17:47	10/12/2020 20:33	10/12/2020 17:47	10/12/2020 20:33	2,76	110	303,54	CHI
20201257518	APARECIDA DE GOIANIA	AP11164428	ATLANTICO S2	10/12/2020 17:47	10/12/2020 20:02	10/12/2020 17:47	10/12/2020 20:02	2,25	117	263,06	CHI
20201257847	SAO DOMINGOS	SD12206118	SAO DOMINGOS	10/12/2020 17:47	11/12/2020 15:54	10/12/2020 17:47	11/12/2020 15:54	22,11	9	198,99	CHI
20201257848	CACU	CC12202698	CACHOEIRA ALTA	10/12/2020 17:48	10/12/2020 20:42	10/12/2020 17:48	10/12/2020 20:42	2,89	4	11,56	CHI
20201257364	GOIANIA	10004862870	ATLANTICO S3	10/12/2020 17:52	11/12/2020 00:26	10/12/2020 17:52	11/12/2020 00:26	6,56	1	6,56	CHI
20201257365	PONTALINA	MI21030686	PONTALINA	10/12/2020 17:52	11/12/2020 19:30	10/12/2020 17:52	11/12/2020 19:30	25,63	1	25,63	CHI
20201257521	SANTA RITA DO NOVO DESTINO	DF12382137	BARRO ALTO	10/12/2020 17:52	12/12/2020 13:15	10/12/2020 17:52	12/12/2020 13:15	43,37	12	520,42	CHI
20201257372	FORMOSA	FA11062256	ITUIQUIRA	10/12/2020 17:54	10/12/2020 22:11	10/12/2020 17:54	10/12/2020 22:11	4,28	197	843,21	CHI
20201257373	CHAPADAO DO CEU	DJ21131313	CHAPADAO DO CEU	10/12/2020 17:54	12/12/2020 01:46	10/12/2020 17:54	12/12/2020 01:46	31,86	1	31,86	CHI
20201257373	CHAPADAO DO CEU	DJ12241801LD	CHAPADAO DO CEU	10/12/2020 17:54	12/12/2020 01:46	10/12/2020 23:42	12/12/2020 01:46	26,07	1	26,07	CHI
20201257376	PALMEIRAS DE GOIAS	PL11277547	PALMEIRAS	10/12/2020 17:54	10/12/2020 19:15	10/12/2020 17:54	10/12/2020 19:15	1,34	1	1,34	CHI
20201257379	MORRO AGUDO DE GOIAS	RB21297343	RUBIATABA	10/12/2020 17:54	10/12/2020 22:13	10/12/2020 17:54	10/12/2020 22:13	4,30	1	4,30	CHI
20201257381	GOUVELANDIA	GB12303224	QUIRINOPOLIS	10/12/2020 17:55	11/12/2020 11:12	10/12/2020 17:55	11/12/2020 11:12	17,28	1	17,28	CHI
20201257387	GOIANIA	10276798	CAMPINAS S2	10/12/2020 17:55	10/12/2020 20:00	10/12/2020 17:55	10/12/2020 20:00	2,07	1	2,07	CHI
20201257741	GOIAS	GS11206974	GOIAS	10/12/2020 17:55	10/12/2020 23:17	10/12/2020 17:55	10/12/2020 23:17	5,36	34	182,29	CHI
20201257394	MUNDO NOVO DE GOIAS	MH12291217LD	NOVA CRIXAS	10/12/2020 17:57	10/12/2020 20:32	10/12/2020 17:57	10/12/2020 20:32	2,57	27	69,48	CHI
20201257425	FORMOSO	10011195434	PORANGATU	10/12/2020 17:57	10/12/2020 20:31	10/12/2020 17:57	10/12/2020 20:31	2,57	1	2,57	CHI
20201257544	POSSE	PS12332779	IACIARA S2	10/12/2020 17:57	10/12/2020 22:02	10/12/2020 17:57	10/12/2020 22:02	4,08	26	105,95	CHI
20201257546	PLANALTINA	PI12218356	PLANALTINA	10/12/2020 17:57	11/12/2020 03:33	10/12/2020 17:57	11/12/2020 03:33	9,59	31	297,15	CHI
20201257578	GUARANI DE GOIAS	GY12393812	IACIARA S1	10/12/2020 17:57	10/12/2020 22:48	10/12/2020 17:57	10/12/2020 22:48	4,85	22	106,63	CHI
20201257467	ARAGOIANIA	AO11291512	GUAPO S2	10/12/2020 17:58	10/12/2020 21:42	10/12/2020 17:58	10/12/2020 21:42	3,73	34	126,91	CHI
20201257489	OUVIDOR	OU12000352	CATALAO S1	10/12/2020 17:58	11/12/2020 00:20	10/12/2020 17:58	11/12/2020 00:20	6,37	32	203,86	CHI
20201257489	TRES RANCHOS	OU12000352	CATALAO S1	10/12/2020 17:58	11/12/2020 00:20	10/12/2020 17:58	11/12/2020 00:20	6,37	8	50,96	CHI
20201257410	SAO DOMINGOS	MA12224219	SAO DOMINGOS	10/12/2020 17:59	10/12/2020 20:46	10/12/2020 17:59	10/12/2020 20:46	2,77	2	5,54	CHI
20201257410	MONTE ALEGRE DE GOIAS	MA12224219	SAO DOMINGOS	10/12/2020 17:59	10/12/2020 20:46	10/12/2020 17:59	10/12/2020 20:46	2,77	33	91,46	CHI
20201257410	CAMPOS BELOS	MA12224219	SAO DOMINGOS	10/12/2020 17:59	10/12/2020 20:46	10/12/2020 17:59	10/12/2020 20:46	2,77	1	2,77	CHI
20201257412	SAO LUIS DE MONTES BELOS	SL21019471	SAO LUIZ DOS MONTES BELOS	10/12/2020 18:00	10/12/2020 21:30	10/12/2020 18:00	10/12/2020 21:30	3,50	2	7,00	CHI
20201257422	PADRE BERNARDO	PB12039344	PADRE BERNARDO	10/12/2020 18:01	10/12/2020 21:01	10/12/2020 18:01	10/12/2020 21:01	3,00	33	98,92	CHI
20201257430	URUACU	640070097	URUACU	10/12/2020 18:03	10/12/2020 22:45	10/12/2020 18:03	10/12/2020 22:45	4,71	1	4,71	CHI
20201257435	GOIANIA	12045597	REAL S1	10/12/2020 18:04	10/12/2020 20:32	10/12/2020 18:04	10/12/2020 20:32	2,46	1	2,46	CHI
20201257438	IPAMERI	IP12318989	PIRES DO RIO S2	10/12/2020 18:04	10/12/2020 23:47	10/12/2020 18:04	10/12/2020 23:47	5,70	3	17,11	CHI
20201257444	IPAMERI	IP12112268	PIRES DO RIO S2	10/12/2020 18:06	11/12/2020 22:24	10/12/2020 18:06	11/12/2020 22:24	28,29	20	565,89	CHI
20201257458	DOVERLANDIA	DV12207929	CAIAPONIA	10/12/2020 18:07	11/12/2020 02:30	10/12/2020 18:07	11/12/2020 02:30	8,40	5	41,99	CHI
20201257450	MORRINHOS	MR21160415	MORRINHOS	10/12/2020 18:08	11/12/2020 09:13	10/12/2020 18:08	11/12/2020 09:13	15,08	1	15,08	CHI
20201257456	PORANGATU	PO21145215	PORANGATU	10/12/2020 18:09	10/12/2020 21:31	10/12/2020 18:09	10/12/2020 21:31	3,36	1	3,36	CHI

20201257883	APARECIDA DO RIO DOCE	AW12191577	CACHOEIRA ALTA	10/12/2020 18:09	11/12/2020 16:38	10/12/2020 18:09	11/12/2020 16:38	22,47	10	224,70	CHI
20201257512	CALDAZINHA	LB12029877	DAIA S2	10/12/2020 18:10	10/12/2020 23:18	10/12/2020 18:10	10/12/2020 23:18	5,12	8	40,98	CHI
20201258546	SANTA FE DE GOIAS	RN12009765	BRITANIA	10/12/2020 18:10	11/12/2020 03:35	10/12/2020 18:10	11/12/2020 03:35	9,41	22	207,08	CHI
20201257484	NIQUELANDIA	NQ12253797	URUACU	10/12/2020 18:11	11/12/2020 09:44	10/12/2020 18:11	11/12/2020 09:44	15,54	22	341,97	CHI
20201257483	PIRACANJUBA	PJ21106690	CALDAS NOVAS S1	10/12/2020 18:12	11/12/2020 01:45	10/12/2020 18:12	11/12/2020 01:45	7,53	2	15,07	CHI
20201258114	MINACU	IH11056161	MINACU	10/12/2020 18:12	11/12/2020 11:53	10/12/2020 18:12	11/12/2020 11:53	17,68	120	2121,97	CHI
20201257486	FAZENDA NOVA	FN21147773	JUSSARA	10/12/2020 18:13	11/12/2020 11:37	10/12/2020 18:13	11/12/2020 11:37	17,40	1	17,40	CHI
20201257488	MONTE ALEGRE DE GOIAS	MA12352872	SAO DOMINGOS	10/12/2020 18:13	10/12/2020 22:57	10/12/2020 18:13	10/12/2020 22:57	4,72	2	9,45	CHI
20201257491	GOIANIA	14528538	CAMPINAS S1	10/12/2020 18:14	10/12/2020 22:53	10/12/2020 18:14	10/12/2020 22:53	4,64	1	4,64	CHI
20201257500	PARAUNA	PU12205939	PARAUNA	10/12/2020 18:14	10/12/2020 22:30	10/12/2020 18:14	10/12/2020 22:30	4,26	8	34,05	CHI
20201257592	PIRACANJUBA	PJ12263257	CALDAS NOVAS S1	10/12/2020 18:14	11/12/2020 08:14	10/12/2020 18:14	11/12/2020 08:14	13,99	9	125,89	CHI
20201257495	AMORINOPOLIS	AM12312073	IPORA	10/12/2020 18:15	10/12/2020 23:38	10/12/2020 18:15	10/12/2020 23:38	5,38	3	16,15	CHI
20201257498	MONTES CLAROS DE GOIAS	ME21140227	IPORA	10/12/2020 18:15	10/12/2020 21:26	10/12/2020 18:15	10/12/2020 21:26	3,17	3	9,52	CHI
20201257505	NIQUELANDIA	NQ21274616	BARRO ALTO	10/12/2020 18:16	10/12/2020 20:31	10/12/2020 18:16	10/12/2020 20:31	2,24	1	2,24	CHI
20201257511	PILAR DE GOIAS	GG12353572	SANTA TEREZINHA	10/12/2020 18:16	11/12/2020 05:06	10/12/2020 18:16	11/12/2020 05:06	10,82	2	21,64	CHI
20201257987	CAMPOS VERDES	VD11037451	SANTA TEREZINHA	10/12/2020 18:16	11/12/2020 01:43	10/12/2020 18:16	11/12/2020 01:43	7,44	65	483,60	CHI
20201258149	FORMOSA	FA12383271	ITUIQUIRA	10/12/2020 18:16	11/12/2020 13:39	10/12/2020 18:16	11/12/2020 13:39	19,39	6	116,34	CHI
20201257655	FLORES DE GOIAS	FB12286863	FLORES DE GOIAS	10/12/2020 18:19	11/12/2020 10:38	10/12/2020 18:19	11/12/2020 10:38	16,31	76	1239,43	CHI
20201257908	SANTA CRUZ DE GOIAS	BC12286288	PIRES DO RIO S2	10/12/2020 18:19	10/12/2020 21:30	10/12/2020 18:19	10/12/2020 21:30	3,18	25	79,47	CHI
20201257527	MINEIROS	10002350570	PARQUE DAS EMAS	10/12/2020 18:20	11/12/2020 14:48	10/12/2020 18:20	11/12/2020 14:48	20,47	1	20,47	CHI
20201258265	SANTA CRUZ DE GOIAS	BC12031892	PIRES DO RIO S2	10/12/2020 18:20	11/12/2020 09:43	10/12/2020 18:20	11/12/2020 09:43	15,38	13	199,93	CHI
20201257529	APARECIDA DO RIO DOCE	JT21033569	CACHOEIRA ALTA	10/12/2020 18:21	11/12/2020 09:02	10/12/2020 18:21	11/12/2020 09:02	14,68	1	14,68	CHI
20201257537	MORRINHOS	MR12000287	MORRINHOS	10/12/2020 18:22	11/12/2020 08:33	10/12/2020 18:22	11/12/2020 08:33	14,17	2	28,34	CHI
20201257654	ACREUNA	EU12000138	ACREUNA	10/12/2020 18:24	10/12/2020 20:36	10/12/2020 18:24	10/12/2020 20:36	2,19	344	752,02	CHI
20201257715	NAZARIO	NZ12299190	ANICUNS	10/12/2020 18:24	10/12/2020 23:38	10/12/2020 18:24	10/12/2020 23:38	5,22	8	41,75	CHI
20201257559	RIO VERDE	10000042119	RIO VERDE S1	10/12/2020 18:25	11/12/2020 09:55	10/12/2020 18:25	11/12/2020 09:55	15,49	1	15,49	CHI
20201257862	BELA VISTA DE GOIAS	BV12029817	BELA VISTA S1	10/12/2020 18:25	10/12/2020 22:17	10/12/2020 18:25	10/12/2020 22:17	3,86	10	38,56	CHI
20201257567	JATAI	290065458	JATAI S2	10/12/2020 18:26	11/12/2020 10:19	10/12/2020 18:26	11/12/2020 10:19	15,87	1	15,87	CHI
20201257836	ITAPACI	RB12161662	RUBIATABA	10/12/2020 18:26	11/12/2020 15:37	10/12/2020 18:26	11/12/2020 15:37	21,17	10	211,68	CHI
20201257836	RUBIATABA	RB12161662	RUBIATABA	10/12/2020 18:26	11/12/2020 15:37	10/12/2020 18:26	11/12/2020 15:37	21,17	32	677,38	CHI
20201257573	PIRENOPOLIS	220048514	CORUMBA	10/12/2020 18:27	10/12/2020 22:28	10/12/2020 18:27	10/12/2020 22:28	4,00	1	4,00	CHI
20201257574	NIQUELANDIA	NQ21274634	BARRO ALTO	10/12/2020 18:28	10/12/2020 22:41	10/12/2020 18:28	10/12/2020 22:41	4,21	2	8,43	CHI
20201257582	SENADOR CANEDO	10009622924	SENADOR CANEDO	10/12/2020 18:29	10/12/2020 20:48	10/12/2020 18:29	10/12/2020 20:48	2,31	1	2,31	CHI
20201257753	VALPARAISO DE GOIAS	VA12090953	MARAJOARA	10/12/2020 18:29	10/12/2020 21:04	10/12/2020 18:29	10/12/2020 21:04	2,58	101	260,13	CHI
20201257591	PIRENOPOLIS	PV21072466	SAO FRANCISCO DE GOIAS	10/12/2020 18:30	10/12/2020 22:53	10/12/2020 18:30	10/12/2020 22:53	4,37	1	4,37	CHI
20201257595	IPORA	730094881	IPORA	10/12/2020 18:31	10/12/2020 21:21	10/12/2020 18:31	10/12/2020 21:21	2,82	1	2,82	CHI
20201257597	FLORES DE GOIAS	FB21421787	FLORES DE GOIAS	10/12/2020 18:31	11/12/2020 17:39	10/12/2020 18:31	11/12/2020 17:39	23,12	2	46,24	CHI
20201257599	GOIANIA	GN12133833	GOIANIA LESTE S3	10/12/2020 18:31	10/12/2020 20:49	10/12/2020 18:31	10/12/2020 20:49	2,28	6	13,71	CHI
20201257743	BELA VISTA DE GOIAS	BV32041307	BELA VISTA S1	10/12/2020 18:31	10/12/2020 20:12	10/12/2020 18:31	10/12/2020 20:12	1,67	9	15,05	CHI
20201257603	DOVERLANDIA	DV11227933	CAIAPONIA	10/12/2020 18:32	11/12/2020 08:10	10/12/2020 18:32	11/12/2020 08:10	13,62	1	13,62	CHI
20201257607	JANDAIA	JD21104577	PALMEIRAS	10/12/2020 18:32	11/12/2020 09:16	10/12/2020 18:32	11/12/2020 09:16	14,72	2	29,44	CHI
20201260436	CAIAPONIA	CP12257526	MONTIVIDIU T	10/12/2020 18:32	11/12/2020 12:20	10/12/2020 18:32	11/12/2020 12:20	17,79	1	17,79	CHI
20201257609	CATALAO	CT12162904	CATALAO S1	10/12/2020 18:33	11/12/2020 09:33	10/12/2020 18:33	11/12/2020 09:33	15,00	9	135,00	CHI
20201257611	SENADOR CANEDO	10013313981	SENADOR CANEDO	10/12/2020 18:33	10/12/2020 20:55	10/12/2020 18:33	10/12/2020 20:55	2,36	1	2,36	CHI
20201257613	FORMOSA	FA11085504	ITUIQUIRA	10/12/2020 18:34	10/12/2020 19:15	10/12/2020 18:34	10/12/2020 19:15	0,68	218	149,09	CHI
20201257616	SANTA HELENA DE GOIAS	SH21325774	SANTA HELENA S1	10/12/2020 18:34	10/12/2020 22:07	10/12/2020 18:34	10/12/2020 22:07	3,55	1	3,55	CHI
20201257617	GOIANIRA	10018359262	MEIA PONTE	10/12/2020 18:35	10/12/2020 22:59	10/12/2020 18:35	10/12/2020 22:59	4,39	1	4,39	CHI
20201257619	GOIANIA	12646696	CAMPINAS S1	10/12/2020 18:35	10/12/2020 22:20	10/12/2020 18:35	10/12/2020 22:20	3,73	1	3,73	CHI
20201257625	BONOPOLIS	BX12364619	SAO MIGUEL DO ARAGUAIA	10/12/2020 18:37	11/12/2020 07:16	10/12/2020 18:37	11/12/2020 07:16	12,65	3	37,94	CHI
20201257629	CRISTALINA	KR21132196	PAMPLONA	10/12/2020 18:38	10/12/2020 22:10	10/12/2020 18:38	10/12/2020 22:10	3,52	6	21,14	CHI
20201257594	AGUAS LINDAS DE GOIAS	LA11149087	AGUAS LINDAS DE GOIAS S1	10/12/2020 18:39	10/12/2020 23:34	10/12/2020 18:39	10/12/2020 23:34	4,91	56	275,05	CHI

20201257634	PIRACANJUBA	60068530	PIRACANJUBA	10/12/2020 18:39	11/12/2020 02:26	10/12/2020 18:39	11/12/2020 02:26	7,78	1	7,78	CHI
20201257636	JATAI	JT21248502	JATAI S3	10/12/2020 18:39	11/12/2020 12:36	10/12/2020 18:39	11/12/2020 12:36	17,94	1	17,94	CHI
20201257641	ANAPOLIS	21040266	ANAPOLIS UNIVERSITARIO S2	10/12/2020 18:40	11/12/2020 00:00	10/12/2020 18:40	11/12/2020 00:00	5,34	1	5,34	CHI
20201257649	SENADOR CANEDO	SW11375184	SENADOR CANEDO	10/12/2020 18:41	10/12/2020 20:19	10/12/2020 18:41	10/12/2020 20:19	1,63	46	74,90	CHI
20201257754	APARECIDA DE GOIANIA	AP11047181	INDEPENDENCIA S1	10/12/2020 18:41	10/12/2020 20:27	10/12/2020 18:41	10/12/2020 20:27	1,75	85	149,17	CHI
20201257714	NEROPOLIS	NR11323329	NEROPOLIS S2	10/12/2020 18:43	10/12/2020 20:28	10/12/2020 18:43	10/12/2020 20:28	1,74	95	165,17	CHI
20201257660	FORMOSA	FA12013352	ITUIQUIRA	10/12/2020 18:44	11/12/2020 14:17	10/12/2020 18:44	11/12/2020 14:17	19,55	3	58,65	CHI
20201257661	GOIANIA	10009018148	INDEPENDENCIA S1	10/12/2020 18:44	10/12/2020 21:45	10/12/2020 18:44	10/12/2020 21:45	3,00	1	3,00	CHI
20201257665	CATALAO	CT21272529	CATALAO S1	10/12/2020 18:45	11/12/2020 09:57	10/12/2020 18:45	11/12/2020 09:57	15,19	1	15,19	CHI
20201257676	PONTALINA	PK32047361	VICENTINOPOLIS	10/12/2020 18:46	10/12/2020 20:46	10/12/2020 18:46	10/12/2020 20:46	1,99	3	5,96	CHI
20201257682	SANTO ANTONIO DO DESCOBERTO	SN12085981	MARAJOARA	10/12/2020 18:47	11/12/2020 02:09	10/12/2020 18:47	11/12/2020 02:09	7,38	24	177,08	CHI
20201257684	NOVO GAMA	10004783296	MARAJOARA	10/12/2020 18:47	10/12/2020 19:57	10/12/2020 18:47	10/12/2020 19:57	1,16	1	1,16	CHI
20201257688	MAIRIPOTABA	MI21000433	PONTALINA	10/12/2020 18:47	11/12/2020 18:00	10/12/2020 18:47	11/12/2020 18:00	23,20	1	23,20	CHI
20201258083	SERRANOPOLIS	SX12260520	JATAI S1	10/12/2020 18:47	10/12/2020 22:36	10/12/2020 18:47	10/12/2020 22:36	3,81	6	22,86	CHI
20201257692	MUNDO NOVO DE GOIAS	4240022035	NOVA CRIXAS	10/12/2020 18:49	10/12/2020 22:04	10/12/2020 18:49	10/12/2020 22:04	3,25	1	3,25	CHI
20201257695	ITABERAI	10016998519	ITABERAI S2	10/12/2020 18:49	10/12/2020 19:57	10/12/2020 18:49	10/12/2020 19:57	1,13	1	1,13	CHI
20201257696	FORMOSA	FA21180867	ITUIQUIRA	10/12/2020 18:49	11/12/2020 11:32	10/12/2020 18:49	11/12/2020 11:32	16,71	1	16,71	CHI
20201257698	IACIARA	IA21262093	IACIARA S1	10/12/2020 18:49	10/12/2020 21:22	10/12/2020 18:49	10/12/2020 21:22	2,54	1	2,54	CHI
20201257845	DOVERLANDIA	DV12207962	CAIAPONIA	10/12/2020 18:50	11/12/2020 00:30	10/12/2020 18:50	11/12/2020 00:30	5,67	7	39,67	CHI
20201257716	GOIANIA	10034869	REAL S2	10/12/2020 18:52	10/12/2020 20:26	10/12/2020 18:52	10/12/2020 20:26	1,56	1	1,56	CHI
20201257717	MINEIROS	MY12296330	PARQUE DAS EMAS	10/12/2020 18:52	11/12/2020 08:28	10/12/2020 18:52	11/12/2020 08:28	13,59	3	40,78	CHI
20201257751	RIO VERDE	RV12295115	RIO VERDE S1	10/12/2020 18:54	10/12/2020 22:25	10/12/2020 18:54	10/12/2020 22:25	3,51	98	344,33	CHI
20201258210	TRES RANCHOS	TH12000452RE	CATALAO S1	10/12/2020 18:54	11/12/2020 01:36	10/12/2020 18:54	11/12/2020 01:36	6,69	16	107,08	CHI
20201257722	GOIANIA	10000681529	MEIA PONTE	10/12/2020 18:55	10/12/2020 20:30	10/12/2020 18:55	10/12/2020 20:30	1,58	1	1,58	CHI
20201257726	RIO VERDE	RV21207143	CABRIUVA S2	10/12/2020 18:55	11/12/2020 00:00	10/12/2020 18:55	11/12/2020 00:00	5,08	1	5,08	CHI
20201258154	CATALAO	CT11000069	CATALAO S2	10/12/2020 18:55	10/12/2020 23:12	10/12/2020 18:55	10/12/2020 23:12	4,28	144	616,64	CHI
20201257729	ITAJA	IJ21200696	ITAJA S2	10/12/2020 18:56	11/12/2020 09:33	10/12/2020 18:56	11/12/2020 09:33	14,62	1	14,62	CHI
20201257736	LUZIANIA	3200153736	MARAJOARA	10/12/2020 18:58	10/12/2020 22:02	10/12/2020 18:58	10/12/2020 22:02	3,05	1	3,05	CHI
20201257738	LUZIANIA	LZ21153860	MARAJOARA	10/12/2020 18:59	11/12/2020 01:52	10/12/2020 18:59	11/12/2020 01:52	6,87	1	6,87	CHI
20201257749	TROMBAS	TB12288317	PORANGATU	10/12/2020 19:02	10/12/2020 21:52	10/12/2020 19:02	10/12/2020 21:52	2,83	6	16,98	CHI
20201257752	MONTE ALEGRE DE GOIAS	MA11397139	SAO DOMINGOS	10/12/2020 19:03	11/12/2020 12:57	10/12/2020 19:03	11/12/2020 12:57	17,90	1	17,90	CHI
20201257758	FAINA	FC21223735	GOIAS	10/12/2020 19:05	10/12/2020 20:38	10/12/2020 19:05	10/12/2020 20:38	1,54	1	1,54	CHI
20201257767	ANAPOLIS	20512960	ANAPOLIS UNIVERSITARIO S2	10/12/2020 19:07	10/12/2020 19:50	10/12/2020 19:07	10/12/2020 19:50	0,70	1	0,70	CHI
20201257772	SANTA TEREZINHA DE GOIAS	GG12171805RE	SANTA TEREZINHA	10/12/2020 19:09	11/12/2020 00:04	10/12/2020 19:09	11/12/2020 00:04	4,91	47	230,68	CHI
20201257772	PILAR DE GOIAS	GG12171805RE	SANTA TEREZINHA	10/12/2020 19:09	11/12/2020 00:04	10/12/2020 19:09	11/12/2020 00:04	4,91	60	294,48	CHI
20201257774	ANAPOLIS	20647750	ANAPOLIS UNIVERSITARIO S2	10/12/2020 19:10	10/12/2020 21:03	10/12/2020 19:10	10/12/2020 21:03	1,88	1	1,88	CHI
20201257779	ITAJA	IJ21214315	ITAJA S2	10/12/2020 19:12	10/12/2020 21:29	10/12/2020 19:12	10/12/2020 21:29	2,28	3	6,85	CHI
20201257780	PLANALTINA	PI11355677	PLANALTINA	10/12/2020 19:12	11/12/2020 08:59	10/12/2020 19:12	11/12/2020 08:59	13,78	1	13,78	CHI
20201257788	AGUAS LINDAS DE GOIAS	LA11148968	AGUAS LINDAS DE GOIAS S1	10/12/2020 19:13	10/12/2020 20:59	10/12/2020 19:13	10/12/2020 20:59	1,77	145	256,17	CHI
20201257789	CACHOEIRA ALTA	CA21024327	CACHOEIRA ALTA	10/12/2020 19:13	11/12/2020 12:31	10/12/2020 19:13	11/12/2020 12:31	17,30	1	17,30	CHI
20201257791	FORMOSA	610228183	ITUIQUIRA	10/12/2020 19:13	10/12/2020 22:55	10/12/2020 19:13	10/12/2020 22:55	3,69	1	3,69	CHI
20201257870	UIRAPURU	UP12287175	SANTA TEREZINHA	10/12/2020 19:15	11/12/2020 05:28	10/12/2020 19:15	11/12/2020 05:28	10,22	3	30,65	CHI
20201258132	CAMPOS VERDES	VD11100887	SANTA TEREZINHA	10/12/2020 19:15	11/12/2020 00:42	10/12/2020 19:15	11/12/2020 00:42	5,45	44	239,62	CHI
20201258603	PILAR DE GOIAS	GG12375656	SANTA TEREZINHA	10/12/2020 19:15	11/12/2020 10:57	10/12/2020 19:15	11/12/2020 10:57	15,68	14	219,58	CHI
20201258603	NOVA IGUACU DE GOIAS	GG12375656	SANTA TEREZINHA	10/12/2020 19:15	11/12/2020 10:57	10/12/2020 19:15	11/12/2020 10:57	15,68	6	94,11	CHI
20201257809	ARAGOIANIA	AO31064659	GUAPO S2	10/12/2020 19:17	10/12/2020 22:03	10/12/2020 19:17	10/12/2020 22:03	2,76	1	2,76	CHI
20201257826	PLANALTINA	PI12078400	PLANALTINA	10/12/2020 19:19	10/12/2020 22:17	10/12/2020 19:19	10/12/2020 22:17	2,95	339	1000,52	CHI
20201257829	PARANAIGUARA	PC12093843	QUIRINOPOLIS	10/12/2020 19:21	11/12/2020 10:54	10/12/2020 19:21	11/12/2020 10:54	15,54	2	31,09	CHI
20201257832	GOIANIA	11819297	REAL S1	10/12/2020 19:22	10/12/2020 21:00	10/12/2020 19:22	10/12/2020 21:00	1,63	1	1,63	CHI
20201257851	ITAPIRAPUA	IU21143118	MATRINCHA	10/12/2020 19:25	11/12/2020 09:46	10/12/2020 19:25	11/12/2020 09:46	14,34	1	14,34	CHI
20201258018	MINACU	IH12360453	MINACU	10/12/2020 19:25	11/12/2020 02:34	10/12/2020 19:25	11/12/2020 02:34	7,14	72	514,12	CHI

20201258018	CAMPINACU	IH12360453	MINACU	10/12/2020 19:25	11/12/2020 02:34	10/12/2020 19:25	11/12/2020 02:34	7,14	5	35,70	CHI
20201257857	ANAPOLIS	10013226183	ANAPOLIS UNIVERSITARIO S2	10/12/2020 19:26	10/12/2020 20:59	10/12/2020 19:26	10/12/2020 20:59	1,56	1	1,56	CHI
20201257858	GOIATUBA	GT21044447	RIO DOS BOIS	10/12/2020 19:26	10/12/2020 23:32	10/12/2020 19:26	10/12/2020 23:32	4,09	1	4,09	CHI
20201257859	APARECIDA DE GOIANIA	AP21251635	INDEPENDENCIA S2	10/12/2020 19:27	11/12/2020 04:40	10/12/2020 19:27	11/12/2020 04:40	9,22	1	9,22	CHI
20201257863	GOIANIA	GN12001382	XAVANTES	10/12/2020 19:27	10/12/2020 21:08	10/12/2020 19:27	10/12/2020 21:08	1,68	1332	2237,76	CHI
20201257865	CALDAS NOVAS	CN11257958	SERRA DE CALDAS	10/12/2020 19:28	10/12/2020 21:35	10/12/2020 19:28	10/12/2020 21:35	2,11	45	94,88	CHI
20201257907	ARAGUAPAZ	AZ12042877	MOZARLANDIA	10/12/2020 19:28	11/12/2020 07:50	10/12/2020 19:28	10/12/2020 22:30	3,03	80	242,13	CHI
20201257907	MOZARLANDIA	AZ12042877	MOZARLANDIA	10/12/2020 19:28	11/12/2020 07:50	10/12/2020 19:28	11/12/2020 07:50	12,36	2	24,72	CHI
20201257907	ARAGUAPAZ	AZ12042877	MOZARLANDIA	10/12/2020 19:28	11/12/2020 07:50	10/12/2020 19:28	11/12/2020 07:50	12,36	7	86,52	CHI
20201257869	SAO JOAO D ALIANCA	JL21144662	SAO JOAO D ALIANCA	10/12/2020 19:29	11/12/2020 10:47	10/12/2020 19:29	11/12/2020 10:47	15,29	2	30,58	CHI
20201257871	CAIAPONIA	CP21020895	CAIAPONIA	10/12/2020 19:29	11/12/2020 08:54	10/12/2020 19:29	11/12/2020 08:54	13,40	1	13,40	CHI
20201257872	GOIANIA	10012215056	GOYA S2	10/12/2020 19:31	11/12/2020 03:08	10/12/2020 19:31	11/12/2020 03:08	7,61	1	7,61	CHI
20201257874	ITAGUARI	II21300339	ITABERAI S1	10/12/2020 19:31	11/12/2020 14:46	10/12/2020 19:31	11/12/2020 14:46	19,25	1	19,25	CHI
20201257878	PROFESSOR JAMIL SAFADY	PJ21357803	ROCHEDO	10/12/2020 19:31	10/12/2020 23:15	10/12/2020 19:31	10/12/2020 23:15	3,72	2	7,44	CHI
20201257882	CASTELANDIA	DM21303642	RIO DOS BOIS	10/12/2020 19:33	10/12/2020 22:22	10/12/2020 19:33	10/12/2020 22:22	2,81	2	5,63	CHI
20201257897	PONTALINA	10021488396	PONTALINA	10/12/2020 19:35	11/12/2020 16:11	10/12/2020 19:35	11/12/2020 16:11	20,61	1	20,61	CHI
20201258317	ABADIANIA	AA12050405	ANAPOLIS UNIVERSITARIO S1	10/12/2020 19:35	10/12/2020 23:12	10/12/2020 19:35	10/12/2020 23:12	3,62	16	57,85	CHI
20201257903	GOIANIA	10003802637	XAVANTES	10/12/2020 19:36	10/12/2020 22:37	10/12/2020 19:36	10/12/2020 22:37	3,01	1	3,01	CHI
20201258819	PORANGATU	PO12027986	PORANGATU	10/12/2020 19:38	11/12/2020 10:06	10/12/2020 19:38	11/12/2020 10:06	14,46	23	332,51	CHI
20201257918	NOVA ROMA	ND12392238	IACIARA S2	10/12/2020 19:39	10/12/2020 20:45	10/12/2020 19:39	10/12/2020 20:45	1,09	245	267,25	CHI
20201257925	LUZIANIA	3200054722	MARAJOARA	10/12/2020 19:41	10/12/2020 21:18	10/12/2020 19:41	10/12/2020 21:18	1,62	1	1,62	CHI
20201257950	SANTA FE DE GOIAS	RN12378892	BRITANIA	10/12/2020 19:43	11/12/2020 10:19	10/12/2020 19:43	11/12/2020 10:19	14,60	19	277,35	CHI
20201257938	APARECIDA DE GOIANIA	11281777	REAL S2	10/12/2020 19:44	10/12/2020 22:13	10/12/2020 19:44	10/12/2020 22:13	2,48	1	2,48	CHI
20201257942	RIO VERDE	RV12338501	CABRIUVA S1	10/12/2020 19:44	11/12/2020 08:35	10/12/2020 19:44	11/12/2020 08:35	12,84	7	89,88	CHI
20201257949	GOIANIA	10007231456	INDEPENDENCIA S2	10/12/2020 19:45	10/12/2020 22:26	10/12/2020 19:45	10/12/2020 22:26	2,67	1	2,67	CHI
20201257951	FIRMINOPOLIS	10021748010	FIRMINOPOLIS S1	10/12/2020 19:45	10/12/2020 22:23	10/12/2020 19:45	10/12/2020 22:23	2,62	1	2,62	CHI
20201257955	JANDAIA	JD21076686	PALMEIRAS	10/12/2020 19:46	11/12/2020 09:47	10/12/2020 19:46	11/12/2020 09:47	14,01	1	14,01	CHI
20201257968	SANTA HELENA DE GOIAS	SH12301345	IPEGUARI	10/12/2020 19:49	10/12/2020 23:31	10/12/2020 19:49	10/12/2020 23:31	3,70	3	11,10	CHI
20201257974	CEZARINA	1650014512	CEZARINA	10/12/2020 19:49	11/12/2020 00:24	10/12/2020 19:49	11/12/2020 00:24	4,58	1	4,58	CHI
20201258025	CACHOEIRA ALTA	CA12196169	CACHOEIRA ALTA	10/12/2020 19:49	11/12/2020 10:39	10/12/2020 19:49	11/12/2020 10:39	14,83	5	74,13	CHI
20201258104	PIRENOPOLIS	PV12000067	CORUMBA	10/12/2020 19:50	11/12/2020 18:28	10/12/2020 19:50	11/12/2020 18:28	22,64	19	430,22	CHI
20201258055	GOIANIA	GN11002743	ATLANTICO S1	10/12/2020 19:52	10/12/2020 21:21	10/12/2020 19:52	10/12/2020 21:21	1,47	175	257,15	CHI
20201257991	OURO VERDE DE GOIAS	OV12033148	NEROPOLIS S1	10/12/2020 19:54	10/12/2020 21:22	10/12/2020 19:54	10/12/2020 21:22	1,46	4	5,84	CHI
20201257991	CAMPO LIMPO	OV12033148	NEROPOLIS S1	10/12/2020 19:54	10/12/2020 21:22	10/12/2020 19:54	10/12/2020 21:22	1,46	2	2,92	CHI
20201258001	NOVA IGUACU DE GOIAS	NH12375437	SANTA TEREZINHA	10/12/2020 19:56	11/12/2020 00:00	10/12/2020 19:56	11/12/2020 00:00	4,06	6	24,33	CHI
20201258128	IPORA	IR12223074	IPORA	10/12/2020 19:57	10/12/2020 22:21	10/12/2020 19:57	10/12/2020 22:21	2,39	178	424,78	CHI
20201258015	POSSE	PS12302641	IACIARA S2	10/12/2020 19:58	10/12/2020 23:57	10/12/2020 19:58	10/12/2020 23:57	3,98	2	7,96	CHI
20201258034	CRISTALINA	KR12304869	CRISTALINA S2	10/12/2020 20:03	10/12/2020 21:32	10/12/2020 20:03	10/12/2020 21:32	1,47	15	22,07	CHI
20201258035	PARAUNA	PU21198712	FIRMINOPOLIS S2	10/12/2020 20:03	11/12/2020 09:47	10/12/2020 20:03	11/12/2020 09:47	13,73	1	13,73	CHI
20201258039	QUIRINOPOLIS	QI21022114	QUIRINOPOLIS	10/12/2020 20:04	11/12/2020 00:03	10/12/2020 20:04	11/12/2020 00:03	3,97	1	3,97	CHI
20201258085	GOIANIA	GN11142838	GOYA S2	10/12/2020 20:06	10/12/2020 22:47	10/12/2020 20:06	10/12/2020 22:47	2,68	195	523,25	CHI
20201258052	ORIZONA	OZ12300550	PIRES DO RIO S2	10/12/2020 20:07	11/12/2020 08:03	10/12/2020 20:07	11/12/2020 08:03	11,93	53	632,22	CHI
20201258053	CALDAS NOVAS	CN11051675	CALDAS NOVAS S2	10/12/2020 20:07	10/12/2020 22:22	10/12/2020 20:07	10/12/2020 22:22	2,24	152	341,20	CHI
20201258158	CAMPOS VERDES	VD11049792	SANTA TEREZINHA	10/12/2020 20:07	10/12/2020 23:37	10/12/2020 20:07	10/12/2020 23:37	3,49	136	474,87	CHI
20201258067	RIO VERDE	630017992	RIO VERDE S1	10/12/2020 20:10	11/12/2020 08:48	10/12/2020 20:10	11/12/2020 08:48	12,63	1	12,63	CHI
20201258088	JUSSARA	JR11009934	JUSSARA	10/12/2020 20:12	10/12/2020 23:00	10/12/2020 20:12	10/12/2020 23:00	2,79	107	298,14	CHI
20201258080	BOM JARDIM DE GOIAS	BM21198366	BOM JARDIM	10/12/2020 20:15	11/12/2020 03:44	10/12/2020 20:15	11/12/2020 03:44	7,47	1	7,47	CHI
20201258081	GOIANIA	13340463	CAMPINAS S2	10/12/2020 20:16	10/12/2020 21:48	10/12/2020 20:16	10/12/2020 21:48	1,53	1	1,53	CHI
20201258082	CASTELANDIA	DM21252740	RIO DOS BOIS	10/12/2020 20:16	10/12/2020 23:19	10/12/2020 20:16	10/12/2020 23:19	3,04	7	21,28	CHI
20201258093	CRISTALINA	KR12183725	CRISTALINA S2	10/12/2020 20:19	10/12/2020 23:18	10/12/2020 20:19	10/12/2020 23:18	2,98	1	2,98	CHI
20201258097	QUIRINOPOLIS	QI21326636	QUIRINOPOLIS	10/12/2020 20:20	11/12/2020 15:16	10/12/2020 20:20	11/12/2020 15:16	18,93	1	18,93	CHI

20201258098	CALDAS NOVAS	760231904	SERRA DE CALDAS	10/12/2020 20:20	10/12/2020 23:10	10/12/2020 20:20	10/12/2020 23:10	2,83	1	2,83	CHI
20201258105	RIO VERDE	RV12191997	MONTIVIDUIU T	10/12/2020 20:22	11/12/2020 08:21	10/12/2020 20:22	11/12/2020 08:21	11,97	3	35,92	CHI
20201258110	TRINDADE	GR31055077	TRINDADE	10/12/2020 20:26	11/12/2020 02:33	10/12/2020 20:26	11/12/2020 02:33	6,12	1	6,12	CHI
20201258112	ANICUNS	AC21403175	ANICUNS	10/12/2020 20:26	11/12/2020 02:10	10/12/2020 20:26	11/12/2020 02:10	5,73	2	11,47	CHI
20201258117	PADRE BERNARDO	ZN12089830	COCALZINHO	10/12/2020 20:26	11/12/2020 05:13	10/12/2020 20:26	11/12/2020 05:13	8,78	1	8,78	CHI
20201258117	COCALZINHO DE GOIAS	ZN12089830	COCALZINHO	10/12/2020 20:26	11/12/2020 05:13	10/12/2020 20:26	11/12/2020 05:13	8,78	10	87,77	CHI
20201258123	TRINDADE	TR31266489	TRINDADE	10/12/2020 20:31	11/12/2020 04:27	10/12/2020 20:31	11/12/2020 04:15	7,73	1	7,73	CHI
20201258123	TRINDADE	TR32053106	TRINDADE	10/12/2020 20:31	11/12/2020 04:27	10/12/2020 20:31	11/12/2020 04:27	7,93	2	15,86	CHI
20201258124	APARECIDA DE GOIANIA	AP11169521	REAL S1	10/12/2020 20:31	10/12/2020 22:40	10/12/2020 20:31	10/12/2020 22:40	2,14	101	216,42	CHI
20201258130	VICENTINOPOLIS	VI12218232	VICENTINOPOLIS	10/12/2020 20:32	11/12/2020 12:27	10/12/2020 20:32	11/12/2020 12:27	15,91	9	143,17	CHI
20201258131	MINEIROS	1390071598	PARQUE DAS EMAS	10/12/2020 20:32	11/12/2020 13:47	10/12/2020 20:32	11/12/2020 13:47	17,24	1	17,24	CHI
20201258133	SANTA RITA DO ARAGUAIA	2130008994	SANTA RITA DO ARAGUAIA	10/12/2020 20:32	11/12/2020 00:08	10/12/2020 20:32	11/12/2020 00:08	3,59	1	3,59	CHI
20201258146	PIRACANJUBA	PJ21038649	PIRACANJUBA	10/12/2020 20:38	11/12/2020 10:10	10/12/2020 20:38	11/12/2020 10:10	13,53	1	13,53	CHI
20201258148	BONOPOLIS	PO21020828	NOVO PLANALTO	10/12/2020 20:38	11/12/2020 09:05	10/12/2020 20:38	11/12/2020 09:05	12,44	1	12,44	CHI
20201258152	IPORA	IR21065116	IPORA	10/12/2020 20:41	11/12/2020 09:23	10/12/2020 20:41	11/12/2020 09:23	12,70	1	12,70	CHI
20201258153	JATAI	JT12061509RE	JATAI S3	10/12/2020 20:41	11/12/2020 11:03	10/12/2020 20:41	11/12/2020 11:03	14,36	9	129,28	CHI
20201258161	APARECIDA DE GOIANIA	AP11164428	ATLANTICO S2	10/12/2020 20:46	10/12/2020 22:31	10/12/2020 20:46	10/12/2020 22:31	1,75	117	204,36	CHI
20201258163	SENADOR CANEDO	SW11188919	SENADOR CANEDO	10/12/2020 20:46	10/12/2020 22:54	10/12/2020 20:46	10/12/2020 22:54	2,12	137	290,44	CHI
20201258354	CAVALCANTE	CJ12286408	MINACU	10/12/2020 20:46	11/12/2020 10:05	10/12/2020 20:46	11/12/2020 10:05	13,32	9	119,85	CHI
20201258167	ANAPOLIS	10005536632	ANAPOLIS UNIVERSITARIO S2	10/12/2020 20:48	10/12/2020 22:19	10/12/2020 20:48	10/12/2020 22:19	1,51	1	1,51	CHI
20201258171	GOIANDIRA	GD12127624RE	CATALAO S1	10/12/2020 20:49	11/12/2020 07:51	10/12/2020 20:49	11/12/2020 07:51	11,02	17	187,30	CHI
20201258171	CATALAO	GD12127624RE	CATALAO S1	10/12/2020 20:49	11/12/2020 07:51	10/12/2020 20:49	11/12/2020 07:51	11,02	14	154,25	CHI
20201258171	IPAMERI	GD12127624RE	CATALAO S1	10/12/2020 20:49	11/12/2020 07:51	10/12/2020 20:49	11/12/2020 07:51	11,02	7	77,12	CHI
20201258172	ANAPOLIS	AN11135792	ANAPOLIS UNIVERSITARIO S1	10/12/2020 20:51	10/12/2020 22:45	10/12/2020 20:51	10/12/2020 22:45	1,90	134	254,60	CHI
20201258179	DOVERLANDIA	DV12354660	CAIAPONIA	10/12/2020 20:54	11/12/2020 10:42	10/12/2020 20:54	11/12/2020 10:42	13,79	7	96,54	CHI
20201258181	APARECIDA DE GOIANIA	10020354370	ANHANGUERA	10/12/2020 20:55	11/12/2020 03:40	10/12/2020 20:55	11/12/2020 03:40	6,75	1	6,75	CHI
20201258400	MINACU	IH12171869	MINACU	10/12/2020 20:55	11/12/2020 02:58	10/12/2020 20:55	11/12/2020 02:58	6,05	77	465,55	CHI
20201258865	ARAGUAPAZ	AZ12210560	MOZARLANDIA	10/12/2020 20:55	11/12/2020 07:50	10/12/2020 20:55	11/12/2020 07:50	10,91	13	141,82	CHI
20201258186	EDEIA	EA12086939	EDEIA	10/12/2020 20:57	11/12/2020 00:15	10/12/2020 20:57	11/12/2020 00:15	3,29	9	29,64	CHI
20201258190	CRISTALINA	KR21245516	PAMPLONA	10/12/2020 20:58	10/12/2020 23:43	10/12/2020 20:58	10/12/2020 23:43	2,75	2	5,49	CHI
20201258193	VILA PROPICIO	550124615	GOIANESIA S1	10/12/2020 20:59	11/12/2020 19:39	10/12/2020 20:59	11/12/2020 19:39	22,66	1	22,66	CHI
20201258196	LUZIANIA	LZ21163799	CRISTALINA S2	10/12/2020 21:01	11/12/2020 00:06	10/12/2020 21:01	11/12/2020 00:06	3,08	1	3,08	CHI
20201258199	LUZIANIA	LZ21155614	CRISTALINA S2	10/12/2020 21:01	11/12/2020 02:03	10/12/2020 21:01	11/12/2020 02:03	5,02	1	5,02	CHI
20201258215	PORANGATU	PO12102916	PORANGATU	10/12/2020 21:01	11/12/2020 01:12	10/12/2020 21:01	11/12/2020 01:12	4,17	27	112,64	CHI
20201258201	COCALZINHO DE GOIAS	ZN21319944	COCALZINHO	10/12/2020 21:03	11/12/2020 17:27	10/12/2020 21:03	11/12/2020 17:27	20,40	1	20,40	CHI
20201258208	GOIANIA	12349744	GOIANIA LESTE S1	10/12/2020 21:06	10/12/2020 21:59	10/12/2020 21:06	10/12/2020 21:59	0,88	1	0,88	CHI
20201258209	GOIANIA	16264800	MEIA PONTE	10/12/2020 21:06	11/12/2020 05:27	10/12/2020 21:06	11/12/2020 05:27	8,33	1	8,33	CHI
20201258227	TRINDADE	TR11111550	TRINDADE	10/12/2020 21:06	10/12/2020 23:49	10/12/2020 21:06	10/12/2020 23:49	2,71	183	495,98	CHI
20201258211	SANTO ANTONIO DE GOIAS	GR31018510	NEROPOLIS S1	10/12/2020 21:08	11/12/2020 02:02	10/12/2020 21:08	11/12/2020 02:02	4,89	1	4,89	CHI
20201258223	ITAJA	IJ12370148	ITAJA S2	10/12/2020 21:13	11/12/2020 07:18	10/12/2020 21:13	11/12/2020 07:18	10,08	2	20,15	CHI
20201258290	APARECIDA DE GOIANIA	AP11402115	INDEPENDENCIA S1	10/12/2020 21:13	11/12/2020 00:06	10/12/2020 21:13	11/12/2020 00:06	2,88	32	92,01	CHI
20201258339	ESTRELA DO NORTE	MU12075219	MARA ROSA	10/12/2020 21:16	11/12/2020 02:10	10/12/2020 21:16	11/12/2020 02:10	4,88	1	4,88	CHI
20201258339	MUTUNOPOLIS	MU12075219	MARA ROSA	10/12/2020 21:16	11/12/2020 02:10	10/12/2020 21:16	11/12/2020 02:10	4,88	8	39,07	CHI
20201258231	APARECIDA DE GOIANIA	13895059	INDEPENDENCIA S2	10/12/2020 21:17	10/12/2020 23:24	10/12/2020 21:17	10/12/2020 23:24	2,10	1	2,10	CHI
20201258235	MOZARLANDIA	10022284522	MOZARLANDIA	10/12/2020 21:19	11/12/2020 07:41	10/12/2020 21:19	11/12/2020 07:41	10,35	1	10,35	CHI
20201259052	RUBIATABA	RB12060966	RUBIATABA	10/12/2020 21:21	11/12/2020 08:43	10/12/2020 21:21	11/12/2020 08:43	11,36	15	170,34	CHI
20201258239	CAVALCANTE	CJ12404476	MINACU	10/12/2020 21:22	11/12/2020 10:59	10/12/2020 21:22	11/12/2020 10:59	13,60	99	1346,46	CHI
20201258240	NOVA ROMA	ND21327507	IACIARA S2	10/12/2020 21:22	11/12/2020 04:29	10/12/2020 21:22	11/12/2020 04:29	7,10	2	14,20	CHI
20201258244	IPAMERI	580110308	IPAMERI	10/12/2020 21:24	11/12/2020 19:19	10/12/2020 21:24	11/12/2020 19:19	21,91	1	21,91	CHI
20201258257	CRIXAS	CX12213587	SANTA TEREZINHA	10/12/2020 21:25	11/12/2020 04:16	10/12/2020 21:25	11/12/2020 04:16	6,84	2	13,67	CHI
20201258257	UIRAPURU	CX12213587	SANTA TEREZINHA	10/12/2020 21:25	11/12/2020 04:16	10/12/2020 21:25	11/12/2020 04:16	6,84	9	61,53	CHI

20201258251	CATALAO	CT12061200	CATALAO S1	10/12/2020 21:27	11/12/2020 10:46	10/12/2020 21:27	11/12/2020 10:46	13,31	5	66,55	CHI
20201258253	FAINA	FC12038664	GOIAS	10/12/2020 21:27	11/12/2020 08:08	10/12/2020 21:27	11/12/2020 08:08	10,67	10	106,74	CHI
20201258255	SAO MIGUEL DO ARAGUAIA	SM12000063RE	SAO MIGUEL DO ARAGUAIA	10/12/2020 21:29	11/12/2020 01:01	10/12/2020 21:29	11/12/2020 01:01	3,52	35	123,16	CHI
20201258256	ALEXANIA	AX21128913	ALEXANIA	10/12/2020 21:30	11/12/2020 07:19	10/12/2020 21:30	11/12/2020 07:19	9,82	1	9,82	CHI
20201258267	GOIANESIA	10002878907	GOIANESIA S2	10/12/2020 21:35	11/12/2020 10:19	10/12/2020 21:35	11/12/2020 10:19	12,73	1	12,73	CHI
20201258289	MINACU	01970214	MINACU	10/12/2020 21:35	10/12/2020 21:38	10/12/2020 21:35	10/12/2020 21:38	0,06	2937	181,93	CHI
20201258269	APARECIDA DE GOIANIA	15001313	ANHANGUERA	10/12/2020 21:36	11/12/2020 00:44	10/12/2020 21:36	11/12/2020 00:44	3,13	1	3,13	CHI
20201258377	ITAPACI	IW12044978	ITAPACI	10/12/2020 21:38	11/12/2020 22:06	10/12/2020 21:38	11/12/2020 22:06	24,46	6	146,79	CHI
20201258280	NOVA AMERICA	RB12272739	RUBIATABA	10/12/2020 21:39	11/12/2020 10:53	10/12/2020 21:39	11/12/2020 10:53	13,22	19	251,13	CHI
20201258280	RUBIATABA	RB12272739	RUBIATABA	10/12/2020 21:39	11/12/2020 10:53	10/12/2020 21:39	11/12/2020 10:53	13,22	13	171,82	CHI
20201258282	GOIANIA	10883745	GOIANIA LESTE S3	10/12/2020 21:40	11/12/2020 00:33	10/12/2020 21:40	11/12/2020 00:33	2,87	1	2,87	CHI
20201258379	ARAGUAPAZ	AZ11042958	MOZARLANDIA	10/12/2020 21:40	11/12/2020 12:39	10/12/2020 21:40	11/12/2020 12:39	14,98	96	1437,84	CHI
20201258291	ITARUMA	IM11382660	ITAJA S2	10/12/2020 21:43	11/12/2020 09:46	10/12/2020 21:43	11/12/2020 09:46	12,04	2	24,08	CHI
20201258307	SANTO ANTONIO DA BARRA	01690224	ACREUNA	10/12/2020 21:44	11/12/2020 17:59	10/12/2020 21:44	11/12/2020 01:42	3,93	25	98,25	CHI
20201258307	RIO VERDE	01690224	ACREUNA	10/12/2020 21:44	11/12/2020 17:59	10/12/2020 21:44	11/12/2020 01:42	3,93	0	0,00	CHI
20201258307	ACREUNA	01690224	ACREUNA	10/12/2020 21:44	11/12/2020 17:59	10/12/2020 21:44	11/12/2020 17:59	20,21	5	101,07	CHI
20201258307	SANTO ANTONIO DA BARRA	BZ12219419LD	ACREUNA	10/12/2020 21:44	11/12/2020 17:59	10/12/2020 21:44	11/12/2020 17:59	20,21	141	2850,04	CHI
20201258307	SANTA HELENA DE GOIAS	BZ12219419LD	ACREUNA	10/12/2020 21:44	11/12/2020 17:59	10/12/2020 21:44	11/12/2020 17:59	20,21	5	101,07	CHI
20201258307	RIO VERDE	BZ12219419LD	ACREUNA	10/12/2020 21:44	11/12/2020 17:59	10/12/2020 21:44	11/12/2020 17:59	20,21	25	505,33	CHI
20201258307	SANTA HELENA DE GOIAS	01690224	ACREUNA	10/12/2020 21:44	11/12/2020 17:59	10/12/2020 21:44	11/12/2020 17:59	20,21	81	1637,26	CHI
20201258307	SANTO ANTONIO DA BARRA	01690224	ACREUNA	10/12/2020 21:44	11/12/2020 17:59	10/12/2020 21:44	11/12/2020 17:59	20,21	32	646,82	CHI
20201258297	ABADIANIA	AA21200975	DAIA S2	10/12/2020 21:45	11/12/2020 02:20	10/12/2020 21:45	11/12/2020 02:20	4,58	1	4,58	CHI
20201258409	MINACU	IH12052532LD	MINACU	10/12/2020 21:47	11/12/2020 17:14	10/12/2020 21:47	11/12/2020 17:14	19,43	353	6860,26	CHI
20201258305	GOIANIA	10788270	CARAJAS S1	10/12/2020 21:48	11/12/2020 03:38	10/12/2020 21:48	11/12/2020 03:38	5,83	1	5,83	CHI
20201258314	APARECIDA DE GOIANIA	16633994	INDEPENDENCIA S1	10/12/2020 21:52	11/12/2020 01:40	10/12/2020 21:52	11/12/2020 01:40	3,80	1	3,80	CHI
20201258319	CRISTALINA	KR21237928	CRISTALINA S2	10/12/2020 21:54	10/12/2020 23:17	10/12/2020 21:54	10/12/2020 23:17	1,38	1	1,38	CHI
20201258743	SANTA FE DE GOIAS	RN12009764	BRITANIA	10/12/2020 21:54	11/12/2020 09:16	10/12/2020 21:54	11/12/2020 09:16	11,36	6	68,14	CHI
20201258326	JOVIANIA	JV21085887	GOIATUBA S1	10/12/2020 21:55	11/12/2020 22:15	10/12/2020 21:55	11/12/2020 22:15	24,32	1	24,32	CHI
20201258335	ITABERAI	AV12272362	ANICUNS	10/12/2020 21:57	11/12/2020 10:16	10/12/2020 21:57	11/12/2020 08:06	10,16	3	30,47	CHI
20201258335	ARACU	AV12272362	ANICUNS	10/12/2020 21:57	11/12/2020 10:16	10/12/2020 21:57	11/12/2020 08:06	10,16	2	20,31	CHI
20201258335	ITABERAI	AV12323612LD	ANICUNS	10/12/2020 21:57	11/12/2020 10:16	10/12/2020 21:57	11/12/2020 09:31	11,56	7	80,95	CHI
20201258335	ITABERAI	AV12037535LD	ANICUNS	10/12/2020 21:57	11/12/2020 10:16	10/12/2020 21:57	11/12/2020 09:50	11,87	3	35,62	CHI
20201258335	ARACU	AV12037535LD	ANICUNS	10/12/2020 21:57	11/12/2020 10:16	10/12/2020 21:57	11/12/2020 09:50	11,87	2	23,75	CHI
20201258335	ITABERAI	AV12054065LD	ANICUNS	10/12/2020 21:57	11/12/2020 10:16	10/12/2020 21:57	11/12/2020 10:16	12,32	4	49,28	CHI
20201258343	PALESTINA DE GOIAS	CP16410129	PALESTINA	10/12/2020 21:58	11/12/2020 15:07	10/12/2020 21:58	11/12/2020 00:51	2,87	46	132,03	CHI
20201258343	CAIAPONIA	CP16410129	PALESTINA	10/12/2020 21:58	11/12/2020 15:07	10/12/2020 21:58	11/12/2020 00:51	2,87	42	120,55	CHI
20201258343	PALESTINA DE GOIAS	PY10406617	PALESTINA	10/12/2020 21:58	11/12/2020 15:07	10/12/2020 21:58	11/12/2020 02:03	4,08	4	16,34	CHI
20201258343	CAIAPONIA	PY10406617	PALESTINA	10/12/2020 21:58	11/12/2020 15:07	10/12/2020 21:58	11/12/2020 04:14	6,27	45	282,15	CHI
20201258343	PALESTINA DE GOIAS	PY10406617	PALESTINA	10/12/2020 21:58	11/12/2020 15:07	11/12/2020 03:18	11/12/2020 04:14	0,95	4	3,80	CHI
20201258343	CAIAPONIA	PY10406617	PALESTINA	10/12/2020 21:58	11/12/2020 15:07	10/12/2020 21:58	11/12/2020 08:04	10,09	47	474,41	CHI
20201258343	PALESTINA DE GOIAS	PY10406617	PALESTINA	10/12/2020 21:58	11/12/2020 15:07	10/12/2020 21:58	11/12/2020 08:04	10,09	12	121,13	CHI
20201258343	CAIAPONIA	PY10406617	PALESTINA	10/12/2020 21:58	11/12/2020 15:07	10/12/2020 21:58	11/12/2020 15:07	17,15	93	1594,54	CHI
20201258343	PALESTINA DE GOIAS	PY10406617	PALESTINA	10/12/2020 21:58	11/12/2020 15:07	10/12/2020 21:58	11/12/2020 15:07	17,15	25	428,64	CHI
20201258342	URUTAI	UT21337287	URUTAI	10/12/2020 22:00	11/12/2020 08:23	10/12/2020 22:00	11/12/2020 08:23	10,38	1	10,38	CHI
20201258352	SAO FRANCISCO DE GOIAS	SF12211814	SAO FRANCISCO DE GOIAS	10/12/2020 22:01	11/12/2020 00:53	10/12/2020 22:01	11/12/2020 00:53	2,86	15	42,92	CHI
20201258557	ITAPACI	IW12405295	ITAPACI	10/12/2020 22:04	11/12/2020 02:29	10/12/2020 22:04	11/12/2020 02:29	4,42	42	185,51	CHI
20201258557	NOVA GLORIA	IW12405295	ITAPACI	10/12/2020 22:04	11/12/2020 02:29	10/12/2020 22:04	11/12/2020 02:29	4,42	1	4,42	CHI
20201258429	ALEXANIA	AX12000099	ALEXANIA	10/12/2020 22:11	11/12/2020 10:43	10/12/2020 22:11	11/12/2020 10:43	12,53	13	162,84	CHI
20201258372	ITUMBIARA	BG21293166	ITUMBIARA VELHA S2	10/12/2020 22:12	12/12/2020 00:55	10/12/2020 22:12	12/12/2020 00:55	26,71	1	26,71	CHI
20201258375	VIANOPOLIS	SV21128984	VIANOPOLIS	10/12/2020 22:13	10/12/2020 23:32	10/12/2020 22:13	10/12/2020 23:32	1,30	1	1,30	CHI
20201258378	PEROLANDIA	DP13000002	JATAI S1	10/12/2020 22:13	11/12/2020 16:16	10/12/2020 22:30	11/12/2020 01:48	3,30	42	138,50	CHI

20201258378	CAIAPONIA	DP13000002	CAIAPONIA	10/12/2020 22:13	11/12/2020 16:16	10/12/2020 22:30	11/12/2020 01:48	3,30	62	204,45	CHI
20201258378	CAIAPONIA	DP13000002	JATAI S1	10/12/2020 22:13	11/12/2020 16:16	10/12/2020 22:30	11/12/2020 01:48	3,30	39	128,60	CHI
20201258378	DOVERLANDIA	DP13000002	CAIAPONIA	10/12/2020 22:13	11/12/2020 16:16	10/12/2020 22:30	11/12/2020 01:48	3,30	3	9,89	CHI
20201258378	MINEIROS	DP13000002	JATAI S1	10/12/2020 22:13	11/12/2020 16:16	10/12/2020 22:30	11/12/2020 01:48	3,30	2	6,60	CHI
20201258378	CAIAPONIA	DP13000002	JATAI S1	10/12/2020 22:13	11/12/2020 16:16	11/12/2020 01:52	11/12/2020 16:16	14,40	39	561,50	CHI
20201258378	CAIAPONIA	DP13000002	CAIAPONIA	10/12/2020 22:13	11/12/2020 16:16	11/12/2020 01:52	11/12/2020 16:16	14,40	62	892,65	CHI
20201258378	DOVERLANDIA	DP13000002	CAIAPONIA	10/12/2020 22:13	11/12/2020 16:16	11/12/2020 01:52	11/12/2020 16:16	14,40	3	43,19	CHI
20201258378	PEROLANDIA	DP13000002	JATAI S1	10/12/2020 22:13	11/12/2020 16:16	11/12/2020 01:52	11/12/2020 16:16	14,40	42	604,70	CHI
20201258378	MINEIROS	DP13000002	JATAI S1	10/12/2020 22:13	11/12/2020 16:16	11/12/2020 01:52	11/12/2020 16:16	14,40	2	28,80	CHI
20201258556	AURILANDIA	CG12382596	FIRMINOPOLIS S2	10/12/2020 22:16	11/12/2020 17:11	10/12/2020 22:16	11/12/2020 13:32	15,27	16	244,27	CHI
20201258556	MOIPORA	CG12382596	FIRMINOPOLIS S2	10/12/2020 22:16	11/12/2020 17:11	10/12/2020 22:16	11/12/2020 13:32	15,27	1	15,27	CHI
20201258556	CACHOEIRA DE GOIAS	CG12382596	FIRMINOPOLIS S2	10/12/2020 22:16	11/12/2020 17:11	10/12/2020 22:16	11/12/2020 13:32	15,27	2	30,53	CHI
20201258556	AURILANDIA	CG32248948	FIRMINOPOLIS S2	10/12/2020 22:16	11/12/2020 17:11	10/12/2020 22:16	11/12/2020 17:11	18,92	8	151,33	CHI
20201258385	SILVANIA	SV12012098	VIANOPOLIS	10/12/2020 22:19	11/12/2020 02:34	10/12/2020 22:19	11/12/2020 02:34	4,24	13	55,08	CHI
20201258392	GOIANIA	GN11000798	GOIANIA LESTE S3	10/12/2020 22:21	11/12/2020 00:38	10/12/2020 22:21	11/12/2020 00:38	2,28	82	186,94	CHI
20201258391	JUSSARA	JR12101970RE	BRITANIA	10/12/2020 22:22	11/12/2020 08:34	10/12/2020 22:22	11/12/2020 08:34	10,19	11	112,05	CHI
20201258393	APARECIDA DE GOIANIA	10001660240	INDEPENDENCIA S2	10/12/2020 22:24	11/12/2020 00:13	10/12/2020 22:24	11/12/2020 00:13	1,81	1	1,81	CHI
20201258907	MATRINCHA	FC12299779	MATRINCHA	10/12/2020 22:28	11/12/2020 09:33	10/12/2020 22:28	11/12/2020 09:33	11,08	37	409,93	CHI
20201258907	FAINA	FC12299779	MATRINCHA	10/12/2020 22:28	11/12/2020 09:33	10/12/2020 22:28	11/12/2020 09:33	11,08	16	177,27	CHI
20201258403	CAIAPONIA	CP12344723	MONTIVIDIU T	10/12/2020 22:29	11/12/2020 14:13	10/12/2020 22:29	11/12/2020 14:13	15,73	8	125,81	CHI
20201258407	PADRE BERNARDO	PB12346973	PADRE BERNARDO	10/12/2020 22:32	11/12/2020 00:11	10/12/2020 22:32	11/12/2020 00:11	1,64	5	8,18	CHI
20201258411	APARECIDA DE GOIANIA	15438340	INDEPENDENCIA S2	10/12/2020 22:35	10/12/2020 23:58	10/12/2020 22:35	10/12/2020 23:58	1,37	1	1,37	CHI
20201258415	BRITANIA	BT12060643	BRITANIA	10/12/2020 22:39	11/12/2020 15:47	10/12/2020 22:39	11/12/2020 15:47	17,12	13	222,61	CHI
20201258418	CAIAPONIA	CP11292042	CAIAPONIA	10/12/2020 22:41	11/12/2020 10:09	10/12/2020 22:41	11/12/2020 10:09	11,45	1	11,45	CHI
20201258431	PLANALTINA	PI11164636	PLANALTINA	10/12/2020 22:42	11/12/2020 00:40	10/12/2020 22:42	11/12/2020 00:40	1,95	373	728,39	CHI
20201258422	RIO VERDE	BZ12048964	ACREUNA	10/12/2020 22:45	11/12/2020 17:50	10/12/2020 22:45	11/12/2020 07:20	8,57	21	179,98	CHI
20201258422	SANTO ANTONIO DA BARRA	BZ12048964	ACREUNA	10/12/2020 22:45	11/12/2020 17:50	10/12/2020 22:45	11/12/2020 07:20	8,57	4	34,28	CHI
20201258422	SANTO ANTONIO DA BARRA	BZ12048964	ACREUNA	10/12/2020 22:45	11/12/2020 17:50	10/12/2020 22:45	11/12/2020 12:35	13,82	34	469,92	CHI
20201258422	RIO VERDE	BZ12048964	ACREUNA	10/12/2020 22:45	11/12/2020 17:50	10/12/2020 22:45	11/12/2020 12:35	13,82	18	248,78	CHI
20201258422	RIO VERDE	BZ12048964	ACREUNA	10/12/2020 22:45	11/12/2020 17:50	10/12/2020 22:45	11/12/2020 16:58	18,21	2	36,42	CHI
20201258422	RIO VERDE	BZ12048964	ACREUNA	10/12/2020 22:45	11/12/2020 17:50	10/12/2020 22:45	11/12/2020 17:50	19,08	1	19,08	CHI
20201258422	SANTO ANTONIO DA BARRA	BZ12048964	ACREUNA	10/12/2020 22:45	11/12/2020 17:50	10/12/2020 22:45	11/12/2020 17:50	19,08	1	19,08	CHI
20201258426	ARUANA	AK12158747	ARUANA	10/12/2020 22:48	11/12/2020 10:19	10/12/2020 22:48	11/12/2020 10:19	11,51	133	1530,50	CHI
20201258438	JARAGUA	JA21345657	JARAGUA	10/12/2020 22:55	11/12/2020 15:28	10/12/2020 22:55	11/12/2020 15:28	16,54	1	16,54	CHI
20201258442	GOIANIA	11850164	GOYA S1	10/12/2020 22:58	11/12/2020 03:45	10/12/2020 22:58	11/12/2020 03:45	4,77	1	4,77	CHI
20201258445	GOIANIA	15677072	MEIA PONTE	10/12/2020 23:01	11/12/2020 00:49	10/12/2020 23:01	11/12/2020 00:49	1,79	1	1,79	CHI
20201258456	MARA ROSA	MQ10403947	MARA ROSA	10/12/2020 23:03	11/12/2020 09:01	10/12/2020 23:03	11/12/2020 03:16	4,22	62	261,57	CHI
20201258456	MARA ROSA	MQ10400799	MARA ROSA	10/12/2020 23:03	11/12/2020 09:01	10/12/2020 23:03	11/12/2020 07:29	8,44	43	362,79	CHI
20201258456	NOVA IGUACU DE GOIAS	MQ10400799	MARA ROSA	10/12/2020 23:03	11/12/2020 09:01	10/12/2020 23:03	11/12/2020 07:29	8,44	13	109,68	CHI
20201258456	URUACU	MQ10400799	MARA ROSA	10/12/2020 23:03	11/12/2020 09:01	10/12/2020 23:03	11/12/2020 07:29	8,44	1	8,44	CHI
20201258456	ALTO HORIZONTE	MQ10400799	MARA ROSA	10/12/2020 23:03	11/12/2020 09:01	10/12/2020 23:03	11/12/2020 07:29	8,44	85	717,14	CHI
20201258456	NOVA IGUACU DE GOIAS	MQ13023844	MARA ROSA	10/12/2020 23:03	11/12/2020 09:01	10/12/2020 23:03	11/12/2020 08:06	9,06	12	108,70	CHI
20201258456	MARA ROSA	MQ13023844	MARA ROSA	10/12/2020 23:03	11/12/2020 09:01	10/12/2020 23:03	11/12/2020 08:06	9,06	109	987,33	CHI
20201258456	URUACU	MQ13023845	MARA ROSA	10/12/2020 23:03	11/12/2020 09:01	11/12/2020 08:41	11/12/2020 09:01	0,34	1	0,34	CHI
20201258456	NOVA IGUACU DE GOIAS	MQ13023845	MARA ROSA	10/12/2020 23:03	11/12/2020 09:01	11/12/2020 08:41	11/12/2020 09:01	0,34	13	4,40	CHI
20201258456	ALTO HORIZONTE	MQ13023845	MARA ROSA	10/12/2020 23:03	11/12/2020 09:01	11/12/2020 08:41	11/12/2020 09:01	0,34	85	28,78	CHI
20201258456	MARA ROSA	MQ13023845	MARA ROSA	10/12/2020 23:03	11/12/2020 09:01	11/12/2020 08:41	11/12/2020 09:01	0,34	43	14,56	CHI
20201259038	ITARUMA	IM12340984	CACHOEIRA ALTA	10/12/2020 23:03	11/12/2020 14:27	10/12/2020 23:03	11/12/2020 14:27	15,40	26	400,33	CHI
20201259805	BURITINOPOLIS	BQ12194634	IACIARA S2	10/12/2020 23:05	11/12/2020 09:51	10/12/2020 23:05	11/12/2020 09:51	10,76	51	548,55	CHI
20201258459	MONTIVIDIU	MV12030664	MONTIVIDIU T	10/12/2020 23:07	11/12/2020 00:42	10/12/2020 23:07	11/12/2020 00:42	1,57	15	23,61	CHI
20201258476	PARAUNA	PU21112589	PARAUNA	10/12/2020 23:19	11/12/2020 07:58	10/12/2020 23:19	11/12/2020 07:58	8,64	1	8,64	CHI

20201258962	FORMOSA	FA12038556	SAO JOAO D ALIANCA	10/12/2020 23:20	11/12/2020 12:10	10/12/2020 23:20	11/12/2020 12:10	12,83	101	1295,58	CHI
20201258962	FLORES DE GOIAS	FA12038556	SAO JOAO D ALIANCA	10/12/2020 23:20	11/12/2020 12:10	10/12/2020 23:20	11/12/2020 12:10	12,83	7	89,79	CHI
20201258496	JARAGUA	JA21134355	JARAGUA	10/12/2020 23:31	11/12/2020 13:55	10/12/2020 23:31	11/12/2020 13:55	14,39	2	28,78	CHI
20201258503	FORMOSO	2410012663	PORANGATU	10/12/2020 23:37	11/12/2020 04:08	10/12/2020 23:37	11/12/2020 04:08	4,51	1	4,51	CHI
20201258504	AURILANDIA	AI12126017	FIRMINOPOLIS S2	10/12/2020 23:37	11/12/2020 01:27	10/12/2020 23:37	11/12/2020 01:27	1,82	5	9,11	CHI
20201258504	CACHOEIRA DE GOIAS	AI12126017	FIRMINOPOLIS S2	10/12/2020 23:37	11/12/2020 01:27	10/12/2020 23:37	11/12/2020 01:27	1,82	4	7,29	CHI
202012179399	SANTA ROSA DE GOIAS	SR12019009	INHUMAS S1	10/12/2020 23:40	11/12/2020 10:03	10/12/2020 23:40	11/12/2020 10:03	10,38	3	31,15	CHI
20201258515	HIDROLANDIA	10031977543	CEPAIGO S2	10/12/2020 23:53	11/12/2020 01:32	10/12/2020 23:53	11/12/2020 01:32	1,63	1	1,63	CHI
20201258516	CATALAO	CT21130165	CATALAO S1	10/12/2020 23:54	11/12/2020 11:50	10/12/2020 23:54	11/12/2020 11:50	11,93	1	11,93	CHI
20201258517	ITABERAI	MD12062634RE	ITABERAI S1	10/12/2020 23:56	11/12/2020 03:42	10/12/2020 23:56	11/12/2020 03:42	3,76	4	15,04	CHI
20201258517	GOIAS	MD12062634RE	ITABERAI S1	10/12/2020 23:56	11/12/2020 03:42	10/12/2020 23:56	11/12/2020 03:42	3,76	5	18,81	CHI
20201258517	MOSSAMEDES	MD12062634RE	ITABERAI S1	10/12/2020 23:56	11/12/2020 03:42	10/12/2020 23:56	11/12/2020 03:42	3,76	198	744,70	CHI
20201258521	RIO VERDE	RV12296245	CABRIUVA S1	11/12/2020 00:00	11/12/2020 22:02	11/12/2020 00:00	11/12/2020 08:36	8,61	3	25,82	CHI
20201258521	RIO VERDE	RV12296022LD	CABRIUVA S1	11/12/2020 00:00	11/12/2020 22:02	11/12/2020 00:00	11/12/2020 22:02	22,04	5	110,20	CHI
20201258522	GOIANIA	10303091	CAMPINAS S2	11/12/2020 00:04	11/12/2020 04:19	11/12/2020 00:04	11/12/2020 04:19	4,24	1	4,24	CHI
20201258524	CALDAZINHA	DE21285496	CEPAIGO S2	11/12/2020 00:13	11/12/2020 01:09	11/12/2020 00:13	11/12/2020 01:09	0,92	2	1,85	CHI
20201258525	ACREUNA	EU21301434	ACREUNA	11/12/2020 00:14	11/12/2020 03:42	11/12/2020 00:14	11/12/2020 03:42	3,46	1	3,46	CHI
20201258572	PLANALTINA	PI12085617RE	PLANALTINA	11/12/2020 00:50	11/12/2020 08:09	11/12/2020 00:50	11/12/2020 08:09	7,30	416	3037,49	CHI
20201258548	ITARUMA	IM12295758	CACHOEIRA ALTA	11/12/2020 01:02	11/12/2020 04:24	11/12/2020 01:02	11/12/2020 04:24	3,36	3	10,08	CHI
20201258552	PALMEIRAS DE GOIAS	PL12000219	PALMEIRAS	11/12/2020 01:18	11/12/2020 11:19	11/12/2020 01:18	11/12/2020 11:19	10,02	11	110,17	CHI
20201258552	PALMEIRAS DE GOIAS	PL12000219	PALMEIRAS	11/12/2020 01:18	11/12/2020 11:19	11/12/2020 04:40	11/12/2020 11:19	6,64	2	13,28	CHI
20201258884	MUNDO NOVO DE GOIAS	MH12391949	NOVA CRIXAS	11/12/2020 01:20	11/12/2020 07:51	11/12/2020 01:20	11/12/2020 07:51	6,51	43	279,82	CHI
20201258560	GOIAS	IB10394756	ITABERAI S2	11/12/2020 01:37	11/12/2020 21:56	11/12/2020 01:37	11/12/2020 03:59	2,37	1	2,37	CHI
20201258560	ITABERAI	IB10394756	ITABERAI S2	11/12/2020 01:37	11/12/2020 21:56	11/12/2020 01:37	11/12/2020 03:59	2,37	158	373,67	CHI
20201258560	ITABERAI	IB13000030	ITABERAI S2	11/12/2020 01:37	11/12/2020 21:56	11/12/2020 01:37	11/12/2020 07:22	5,74	44	252,51	CHI
20201258560	GOIAS	IB13000030	ITABERAI S2	11/12/2020 01:37	11/12/2020 21:56	11/12/2020 01:37	11/12/2020 07:22	5,74	107	614,06	CHI
20201258560	GOIAS	IB10394756	ITABERAI S2	11/12/2020 01:37	11/12/2020 21:56	11/12/2020 09:27	11/12/2020 10:12	0,75	68	50,87	CHI
20201258560	ITABERAI	IB10394756	ITABERAI S2	11/12/2020 01:37	11/12/2020 21:56	11/12/2020 09:27	11/12/2020 10:12	0,75	202	151,11	CHI
20201258560	ITABERAI	IB13000031	ITABERAI S2	11/12/2020 01:37	11/12/2020 21:56	11/12/2020 01:37	11/12/2020 11:20	9,71	21	203,87	CHI
20201258560	MOSSAMEDES	IB13274429	ITABERAI S2	11/12/2020 01:37	11/12/2020 21:56	11/12/2020 01:37	11/12/2020 21:56	20,31	263	5341,31	CHI
20201258560	ITABERAI	IB13274429	ITABERAI S2	11/12/2020 01:37	11/12/2020 21:56	11/12/2020 01:37	11/12/2020 21:56	20,31	26	528,04	CHI
20201258573	PADRE BERNARDO	PB12335637	PADRE BERNARDO	11/12/2020 02:19	11/12/2020 03:15	11/12/2020 02:19	11/12/2020 03:15	0,92	23	21,18	CHI
20201258575	CRIXAS	MZ10400739	RUBIATABA	11/12/2020 02:22	11/12/2020 11:14	11/12/2020 02:22	11/12/2020 09:12	6,83	37	252,82	CHI
20201258575	CRIXAS	MZ10400739	RUBIATABA	11/12/2020 02:22	11/12/2020 11:14	11/12/2020 02:22	11/12/2020 11:14	8,88	16	142,02	CHI
20201258578	NOVA IGUACU DE GOIAS	CX12201729LD	RUBIATABA	11/12/2020 02:22	11/12/2020 15:25	11/12/2020 02:22	11/12/2020 13:20	10,96	1	10,96	CHI
20201258578	CRIXAS	CX12201729LD	RUBIATABA	11/12/2020 02:22	11/12/2020 15:25	11/12/2020 02:22	11/12/2020 13:20	10,96	226	2477,65	CHI
20201258578	CRIXAS	CX12181454LD	RUBIATABA	11/12/2020 02:22	11/12/2020 15:25	11/12/2020 02:22	11/12/2020 15:25	13,05	17	221,87	CHI
20201258579	AMORINOPOLIS	AM21138512	IPORA	11/12/2020 02:23	11/12/2020 08:29	11/12/2020 02:23	11/12/2020 08:29	6,09	3	18,28	CHI
20201258608	SANTO ANTONIO DO DESCOBERTO	SN12389382	MARAJOARA	11/12/2020 03:02	11/12/2020 07:19	11/12/2020 03:02	11/12/2020 07:19	4,28	79	337,88	CHI
20201258608	ALEXANIA	SN12389382	MARAJOARA	11/12/2020 03:02	11/12/2020 07:19	11/12/2020 03:02	11/12/2020 07:19	4,28	2	8,55	CHI
20201258585	GUARANI DE GOIAS	GY12180835	IACIARA S1	11/12/2020 03:27	11/12/2020 08:51	11/12/2020 03:27	11/12/2020 08:51	5,40	337	1819,24	CHI
20201258585	IACIARA	GY12180835	IACIARA S1	11/12/2020 03:27	11/12/2020 08:51	11/12/2020 03:27	11/12/2020 08:51	5,40	2	10,80	CHI
20201258586	CALDAS NOVAS	CN12213938	SERRA DE CALDAS	11/12/2020 03:33	11/12/2020 05:05	11/12/2020 03:33	11/12/2020 05:05	1,53	33	50,49	CHI
20201258587	GOIANIA	GN11047750	ATLANTICO S3	11/12/2020 03:34	11/12/2020 06:25	11/12/2020 03:34	11/12/2020 06:25	2,85	25	71,25	CHI
20201258621	PORANGATU	PO12141125	NOVO PLANALTO	11/12/2020 03:38	11/12/2020 07:46	11/12/2020 03:38	11/12/2020 07:46	4,13	13	53,68	CHI
20201258897	PETROLINA DE GOIAS	PG16413905	INHUMAS S1	11/12/2020 03:38	11/12/2020 09:31	11/12/2020 03:38	11/12/2020 06:35	2,94	48	141,05	CHI
20201258897	SANTA ROSA DE GOIAS	PG16413905	INHUMAS S1	11/12/2020 03:38	11/12/2020 09:31	11/12/2020 03:38	11/12/2020 06:35	2,94	386	1134,30	CHI
20201258897	SANTA ROSA DE GOIAS	PG16413905	INHUMAS S1	11/12/2020 03:38	11/12/2020 09:31	11/12/2020 06:30	11/12/2020 06:35	0,07	186	13,07	CHI
20201258897	PETROLINA DE GOIAS	PG16413905	INHUMAS S1	11/12/2020 03:38	11/12/2020 09:31	11/12/2020 06:30	11/12/2020 06:35	0,07	1	0,07	CHI
20201258897	SANTA ROSA DE GOIAS	PG16413905	INHUMAS S1	11/12/2020 03:38	11/12/2020 09:31	11/12/2020 03:38	11/12/2020 09:31	5,87	28	164,48	CHI
20201258897	PETROLINA DE GOIAS	PG16413905	INHUMAS S1	11/12/2020 03:38	11/12/2020 09:31	11/12/2020 03:38	11/12/2020 09:31	5,87	81	475,83	CHI

20201258897	ITAUCU	PG16413905	INHUMAS S1	11/12/2020 03:38	11/12/2020 09:31	11/12/2020 03:38	11/12/2020 09:31	5,87	6	35,25	CHI
20201258897	SANTA ROSA DE GOIAS	SR10413906	INHUMAS S1	11/12/2020 03:38	11/12/2020 09:31	11/12/2020 06:30	11/12/2020 09:31	3,01	4	12,02	CHI
20201258596	SAO LUIZ DO NORTE	SZ10410838	ITAPACI	11/12/2020 03:46	11/12/2020 18:59	11/12/2020 03:46	11/12/2020 12:01	8,25	123	1014,34	CHI
20201258596	SANTA ISABEL	SZ10410838	ITAPACI	11/12/2020 03:46	11/12/2020 18:59	11/12/2020 03:46	11/12/2020 14:31	10,74	4	42,96	CHI
20201258596	GOIANESIA	SZ10410838	ITAPACI	11/12/2020 03:46	11/12/2020 18:59	11/12/2020 03:46	11/12/2020 14:31	10,74	8	85,92	CHI
20201258596	SAO LUIZ DO NORTE	SZ10410838	ITAPACI	11/12/2020 03:46	11/12/2020 18:59	11/12/2020 03:46	11/12/2020 14:31	10,74	31	332,94	CHI
20201258596	SANTA ISABEL	SZ10410838	ITAPACI	11/12/2020 03:46	11/12/2020 18:59	11/12/2020 03:46	11/12/2020 16:08	12,36	1	12,36	CHI
20201258596	GOIANESIA	SZ10410838	ITAPACI	11/12/2020 03:46	11/12/2020 18:59	11/12/2020 03:46	11/12/2020 16:08	12,36	3	37,08	CHI
20201258596	GOIANESIA	SZ10410838	ITAPACI	11/12/2020 03:46	11/12/2020 18:59	11/12/2020 03:46	11/12/2020 18:59	15,21	1	15,21	CHI
20201258694	JARAGUA	JA12374473	JARAGUA	11/12/2020 03:54	11/12/2020 06:46	11/12/2020 03:54	11/12/2020 06:46	2,85	301	858,18	CHI
20201258602	ANAPOLIS	AN13374436	ANAPOLIS UNIVERSITARIO S1	11/12/2020 04:11	11/12/2020 09:52	11/12/2020 04:11	11/12/2020 09:52	5,69	347	1972,70	CHI
20201258602	ABADIANIA	AN13374436	ANAPOLIS UNIVERSITARIO S1	11/12/2020 04:11	11/12/2020 09:52	11/12/2020 04:11	11/12/2020 09:52	5,69	70	397,95	CHI
20201258604	ITARUMA	IM12279901	CACHOEIRA ALTA	11/12/2020 04:14	11/12/2020 08:55	11/12/2020 04:14	11/12/2020 08:55	4,67	19	88,71	CHI
20201258604	ITAJA	IM12279901	CACHOEIRA ALTA	11/12/2020 04:14	11/12/2020 08:55	11/12/2020 04:14	11/12/2020 08:55	4,67	11	51,36	CHI
20201258606	PARANAIGUARA	PC21066115	QUIRINOPOLIS	11/12/2020 04:18	11/12/2020 12:05	11/12/2020 04:18	11/12/2020 12:05	7,78	1	7,78	CHI
20201258607	NAZARIO	NZ21076353	ANICUNS	11/12/2020 04:18	11/12/2020 09:54	11/12/2020 04:18	11/12/2020 09:54	5,59	4	22,36	CHI
20201258880	NOVO BRASIL	NB11020195	JUSSARA	11/12/2020 04:21	11/12/2020 08:52	11/12/2020 04:21	11/12/2020 08:52	4,53	128	579,34	CHI
20201258612	ACREUNA	EU12260934	ACREUNA	11/12/2020 04:24	11/12/2020 09:10	11/12/2020 04:24	11/12/2020 09:10	4,75	4	19,02	CHI
20201259090	SAO FRANCISCO DE GOIAS	PG12298071	PETROLINA	11/12/2020 04:24	11/12/2020 11:20	11/12/2020 04:24	11/12/2020 11:20	6,93	1	6,93	CHI
20201259090	PETROLINA DE GOIAS	PG12298071	PETROLINA	11/12/2020 04:24	11/12/2020 11:20	11/12/2020 04:24	11/12/2020 11:20	6,93	45	311,70	CHI
20201258740	MOZARLANDIA	AZ12290380	MOZARLANDIA	11/12/2020 04:28	11/12/2020 09:10	11/12/2020 04:28	11/12/2020 09:10	4,68	2	9,37	CHI
20201258740	ARAGUAPAZ	AZ12290380	MOZARLANDIA	11/12/2020 04:28	11/12/2020 09:10	11/12/2020 04:28	11/12/2020 09:10	4,68	7	32,79	CHI
20201258653	VIANOPOLIS	SQ12343457RE	CRISTIANOPOLIS	11/12/2020 04:40	11/12/2020 11:22	11/12/2020 04:40	11/12/2020 11:22	6,69	18	120,37	CHI
20201258653	SAO MIGUEL DO PASSA QUATRO	SQ12343457RE	CRISTIANOPOLIS	11/12/2020 04:40	11/12/2020 11:22	11/12/2020 04:40	11/12/2020 11:22	6,69	15	100,31	CHI
20201258797	GAMELEIRA DE GOIAS	00020224	ANAPOLIS UNIVERSITARIO S1	11/12/2020 04:44	11/12/2020 18:20	11/12/2020 04:44	11/12/2020 08:07	3,39	33	111,86	CHI
20201258797	ABADIANIA	00020224	ANAPOLIS UNIVERSITARIO S1	11/12/2020 04:44	11/12/2020 18:20	11/12/2020 04:44	11/12/2020 08:07	3,39	135	457,61	CHI
20201258797	ANAPOLIS	00020224	ANAPOLIS UNIVERSITARIO S1	11/12/2020 04:44	11/12/2020 18:20	11/12/2020 04:44	11/12/2020 08:07	3,39	371	1257,59	CHI
20201258797	ANAPOLIS	00020224	ANAPOLIS UNIVERSITARIO S1	11/12/2020 04:44	11/12/2020 18:20	11/12/2020 08:08	11/12/2020 10:44	2,59	324	838,71	CHI
20201258797	ANAPOLIS	AN13376523	ANAPOLIS UNIVERSITARIO S1	11/12/2020 04:44	11/12/2020 18:20	11/12/2020 08:08	11/12/2020 12:44	4,60	55	252,85	CHI
20201258797	GAMELEIRA DE GOIAS	AN13376523	ANAPOLIS UNIVERSITARIO S1	11/12/2020 04:44	11/12/2020 18:20	11/12/2020 08:08	11/12/2020 12:44	4,60	5	22,99	CHI
20201258797	ABADIANIA	AN13376523	ANAPOLIS UNIVERSITARIO S1	11/12/2020 04:44	11/12/2020 18:20	11/12/2020 08:08	11/12/2020 12:44	4,60	6	27,58	CHI
20201258797	ABADIANIA	AN13382470	ANAPOLIS UNIVERSITARIO S1	11/12/2020 04:44	11/12/2020 18:20	11/12/2020 08:08	11/12/2020 18:20	10,20	132	1346,11	CHI
20201258797	GAMELEIRA DE GOIAS	AN13382470	ANAPOLIS UNIVERSITARIO S1	11/12/2020 04:44	11/12/2020 18:20	11/12/2020 08:08	11/12/2020 18:20	10,20	29	295,74	CHI
20201258620	OURO VERDE DE GOIAS	OV12215905	NEROPOLIS S2	11/12/2020 04:48	11/12/2020 12:12	11/12/2020 04:48	11/12/2020 12:12	7,40	10	73,98	CHI
20201258908	LUZIANIA	OZ12186208	PIRES DO RIO S2	11/12/2020 04:51	11/12/2020 15:33	11/12/2020 04:51	11/12/2020 15:33	10,69	32	341,99	CHI
20201258757	PEROLANDIA	JT18000231TS	JATAI S1	11/12/2020 04:54	11/12/2020 21:29	11/12/2020 04:54	11/12/2020 21:29	16,59	3	49,78	CHI
20201258757	JATAI	JT18000231TS	JATAI S1	11/12/2020 04:54	11/12/2020 21:29	11/12/2020 04:54	11/12/2020 21:29	16,59	73	1211,21	CHI
20201258735	BOM JESUS DE GOIAS	BJ12392126	BOM JESUS DE GOIAS	11/12/2020 04:56	11/12/2020 09:48	11/12/2020 04:56	11/12/2020 09:48	4,85	139	674,57	CHI
20201258816	GOIATUBA	GT12296905	GOIATUBA S2	11/12/2020 05:02	11/12/2020 09:58	11/12/2020 05:02	11/12/2020 09:58	4,93	7	34,49	CHI
20201258632	ITAPACI	IW21181552	ITAPACI	11/12/2020 05:04	11/12/2020 12:57	11/12/2020 05:04	11/12/2020 12:57	7,88	1	7,88	CHI
20201259416	IPAMERI	IP12042440	IPAMERI	11/12/2020 05:05	11/12/2020 10:32	11/12/2020 05:05	11/12/2020 10:32	5,44	3	16,32	CHI
20201259639	GOIAS	GS12068549	MATRINCHA	11/12/2020 05:05	11/12/2020 13:01	11/12/2020 05:05	11/12/2020 13:01	7,93	8	63,42	CHI
20201258755	ITAPACI	IW12201633	ITAPACI	11/12/2020 05:06	11/12/2020 08:41	11/12/2020 05:06	11/12/2020 08:41	3,58	11	39,42	CHI
20201256421	INACIOLANDIA	ID12271589	CACHOEIRA DOURADA	11/12/2020 05:09	11/12/2020 13:36	11/12/2020 05:09	11/12/2020 13:36	8,43	16	134,95	CHI
20201258643	MUTUNOPOLIS	MU12129781	MARA ROSA	11/12/2020 05:11	11/12/2020 08:54	11/12/2020 05:11	11/12/2020 08:54	3,70	7	25,90	CHI
20201258878	POSSE	PS12189370	IACIARA S2	11/12/2020 05:11	11/12/2020 07:32	11/12/2020 05:11	11/12/2020 07:32	2,35	4	9,39	CHI
20201258878	MAMBAI	PS12189370	IACIARA S2	11/12/2020 05:11	11/12/2020 07:32	11/12/2020 05:11	11/12/2020 07:32	2,35	28	65,70	CHI
20201258878	BURITINOPOLIS	PS12189370	IACIARA S2	11/12/2020 05:11	11/12/2020 07:32	11/12/2020 05:11	11/12/2020 07:32	2,35	2	4,69	CHI
20201258644	PORANGATU	PO12321070	NOVO PLANALTO	11/12/2020 05:12	11/12/2020 08:09	11/12/2020 05:12	11/12/2020 08:09	2,94	21	61,82	CHI
20201258645	PONTALINA	PK12189810	PONTALINA	11/12/2020 05:14	11/12/2020 09:00	11/12/2020 05:14	11/12/2020 09:00	3,77	3	11,30	CHI
20201258647	GOIANIA	GN11151331	GOIANIA LESTE S3	11/12/2020 05:15	11/12/2020 09:21	11/12/2020 08:55	11/12/2020 09:21	0,43	3	1,30	CHI

20201258648	TURVELANDIA	TD11170324	RIO DOS BOIS	11/12/2020 05:18	11/12/2020 08:24	11/12/2020 05:18	11/12/2020 08:24	3,08	106	326,92	CHI
20201258651	COCALZINHO DE GOIAS	ZN12295711	COCALZINHO	11/12/2020 05:20	12/12/2020 13:30	11/12/2020 05:20	11/12/2020 15:43	10,39	1	10,39	CHI
20201258651	COCALZINHO DE GOIAS	ZN12295711	COCALZINHO	11/12/2020 05:20	12/12/2020 13:30	11/12/2020 20:22	11/12/2020 23:13	2,86	4	11,44	CHI
20201258651	COCALZINHO DE GOIAS	ZN12295711	COCALZINHO	11/12/2020 05:20	12/12/2020 13:30	12/12/2020 11:24	12/12/2020 13:30	2,10	4	8,39	CHI
20201258680	ACREUNA	EA12257973	EDEIA	11/12/2020 05:20	11/12/2020 09:19	11/12/2020 05:20	11/12/2020 09:19	3,98	13	51,71	CHI
20201258680	EDEIA	EA12257973	EDEIA	11/12/2020 05:20	11/12/2020 09:19	11/12/2020 05:20	11/12/2020 09:19	3,98	32	127,29	CHI
20201258680	INDIARA	EA12257973	EDEIA	11/12/2020 05:20	11/12/2020 09:19	11/12/2020 05:20	11/12/2020 09:19	3,98	7	27,84	CHI
20201258909	FAINA	GS12086336	GOIAS	11/12/2020 05:21	11/12/2020 12:26	11/12/2020 05:21	11/12/2020 12:26	7,08	30	212,46	CHI
20201258655	ORIZONA	OZ12022882	PIRES DO RIO S2	11/12/2020 05:25	11/12/2020 19:20	11/12/2020 05:25	11/12/2020 09:13	3,80	17	64,52	CHI
20201258655	ORIZONA	OZ21300770	PIRES DO RIO S2	11/12/2020 05:25	11/12/2020 19:20	11/12/2020 05:25	11/12/2020 19:19	13,90	2	27,79	CHI
20201258655	ORIZONA	OZ21111526	PIRES DO RIO S2	11/12/2020 05:25	11/12/2020 19:20	11/12/2020 05:25	11/12/2020 19:20	13,91	1	13,91	CHI
20201258656	CRISTALINA	KR12074918	CRISTALINA S2	11/12/2020 05:25	11/12/2020 07:46	11/12/2020 05:25	11/12/2020 07:46	2,34	8	18,70	CHI
20201258658	CAIAPONIA	CP12200873	PALESTINA	11/12/2020 05:26	11/12/2020 11:23	11/12/2020 05:26	11/12/2020 11:23	5,94	98	582,23	CHI
20201259476	INHUMAS	IN11219974	INHUMAS S2	11/12/2020 05:26	11/12/2020 11:33	11/12/2020 05:26	11/12/2020 11:33	6,11	47	286,97	CHI
20201259606	MINACU	IH12171869	MINACU	11/12/2020 05:27	11/12/2020 11:51	11/12/2020 05:27	11/12/2020 11:51	6,39	77	492,31	CHI
20201258662	SAO MIGUEL DO ARAGUAIA	SM12342059	SAO MIGUEL DO ARAGUAIA	11/12/2020 05:29	11/12/2020 13:15	11/12/2020 05:29	11/12/2020 13:15	7,76	9	69,86	CHI
20201258665	APARECIDA DE GOIANIA	200140565	INDEPENDENCIA S2	11/12/2020 05:29	11/12/2020 08:41	11/12/2020 05:29	11/12/2020 08:41	3,19	1	3,19	CHI
20201258714	ITAPIRAPUA	IU12018852	MATRINCHA	11/12/2020 05:30	11/12/2020 16:13	11/12/2020 05:30	11/12/2020 16:04	10,56	36	380,29	CHI
20201258714	ITAPIRAPUA	IU12018844	MATRINCHA	11/12/2020 05:30	11/12/2020 16:13	11/12/2020 09:46	11/12/2020 16:13	6,47	1	6,47	CHI
20201258668	ANICUNS	AC12259100	ANICUNS	11/12/2020 05:32	11/12/2020 08:00	11/12/2020 05:32	11/12/2020 08:00	2,47	14	34,51	CHI
20201258675	VILA PROPICIO	NP12339454	GOIANESIA S1	11/12/2020 05:33	11/12/2020 09:33	11/12/2020 05:33	11/12/2020 09:33	3,99	112	446,97	CHI
20201258889	MARA ROSA	MQ12208423	MARA ROSA	11/12/2020 05:33	11/12/2020 09:31	11/12/2020 05:33	11/12/2020 09:31	3,96	12	47,50	CHI
20201258692	TROMBAS	TB12143685	PORANGATU	11/12/2020 05:34	11/12/2020 08:09	11/12/2020 05:34	11/12/2020 08:09	2,58	19	49,01	CHI
20201258692	MONTIVIDIU DO NORTE	TB12143685	PORANGATU	11/12/2020 05:34	11/12/2020 08:09	11/12/2020 05:34	11/12/2020 08:09	2,58	10	25,79	CHI
20201258676	GOIANIA	10006063002	FERROVIARIO S2	11/12/2020 05:35	11/12/2020 07:32	11/12/2020 05:35	11/12/2020 07:32	1,94	1	1,94	CHI
20201258979	FORMOSA	FA12404372	ITUIQUIRA	11/12/2020 05:35	11/12/2020 13:12	11/12/2020 05:35	11/12/2020 13:12	7,60	164	1246,49	CHI
20201259760	MONTES CLAROS DE GOIAS	ME12124936	IPORA	11/12/2020 05:38	11/12/2020 15:07	11/12/2020 05:38	11/12/2020 15:07	9,48	10	94,79	CHI
20201258898	COLINAS DO SUL	TI12156244RE	MINACU	11/12/2020 05:40	12/12/2020 20:13	11/12/2020 05:40	12/12/2020 20:13	38,54	69	2659,11	CHI
20201258687	ITABERAI	00120224	ARACU	11/12/2020 05:41	11/12/2020 07:51	11/12/2020 05:41	11/12/2020 07:51	2,16	10	21,58	CHI
20201258687	GOIANIRA	00120224	ARACU	11/12/2020 05:41	11/12/2020 07:51	11/12/2020 05:41	11/12/2020 07:51	2,16	1	2,16	CHI
20201258687	INHUMAS	00120224	ARACU	11/12/2020 05:41	11/12/2020 07:51	11/12/2020 05:41	11/12/2020 07:51	2,16	6	12,95	CHI
20201258687	CATURAI	00120224	ARACU	11/12/2020 05:41	11/12/2020 07:51	11/12/2020 05:41	11/12/2020 07:51	2,16	86	185,62	CHI
20201258687	ARACU	00120224	ARACU	11/12/2020 05:41	11/12/2020 07:51	11/12/2020 05:41	11/12/2020 07:51	2,16	33	71,22	CHI
20201259244	PONTALINA	EA12223551RE	EDEIA	11/12/2020 05:41	11/12/2020 09:16	11/12/2020 05:41	11/12/2020 09:16	3,57	1	3,57	CHI
20201259244	EDEIA	EA12223551RE	EDEIA	11/12/2020 05:41	11/12/2020 09:16	11/12/2020 05:41	11/12/2020 09:16	3,57	63	225,21	CHI
20201259244	INDIARA	EA12223551RE	EDEIA	11/12/2020 05:41	11/12/2020 09:16	11/12/2020 05:41	11/12/2020 09:16	3,57	4	14,30	CHI
20201258695	POSSE	PS12143770	IACIARA S2	11/12/2020 05:44	11/12/2020 09:02	11/12/2020 05:44	11/12/2020 09:02	3,30	112	369,23	CHI
20201258699	PONTALINA	PK12390272	PONTALINA	11/12/2020 05:45	11/12/2020 08:47	11/12/2020 05:45	11/12/2020 08:47	3,02	5	15,10	CHI
20201259584	PONTALINA	PK12047233	PONTALINA	11/12/2020 05:45	11/12/2020 11:01	11/12/2020 05:45	11/12/2020 11:01	5,27	14	73,71	CHI
20201258704	ARAGUAPAZ	AZ21274265	MOZARLANDIA	11/12/2020 05:47	11/12/2020 10:30	11/12/2020 05:47	11/12/2020 10:30	4,71	2	9,41	CHI
20201258802	PIRENOPOLIS	JA12273331	JARAGUA	11/12/2020 05:48	11/12/2020 09:30	11/12/2020 05:48	11/12/2020 09:30	3,69	29	107,02	CHI
20201258802	JARAGUA	JA12273331	JARAGUA	11/12/2020 05:48	11/12/2020 09:30	11/12/2020 05:48	11/12/2020 09:30	3,69	15	55,35	CHI
20201258800	ARAGOIANIA	AO32021484	GUAPO S2	11/12/2020 05:49	11/12/2020 10:53	11/12/2020 05:49	11/12/2020 10:53	5,05	5	25,27	CHI
20201258926	APARECIDA DE GOIANIA	AP12000269	CEPAIGO S1	11/12/2020 05:49	11/12/2020 08:35	11/12/2020 05:49	11/12/2020 08:35	2,75	60	165,03	CHI
20201256903	NIQUELANDIA	NQ12201753LD	URUACU	11/12/2020 05:50	11/12/2020 19:02	11/12/2020 05:50	11/12/2020 11:44	5,90	42	247,74	CHI
20201256903	NIQUELANDIA	NQ12201753LD	URUACU	11/12/2020 05:50	11/12/2020 19:02	11/12/2020 05:50	11/12/2020 19:02	13,20	30	396,12	CHI
20201256903	NIQUELANDIA	NQ12201753LD	URUACU	11/12/2020 05:50	11/12/2020 19:02	11/12/2020 12:02	11/12/2020 19:02	7,01	42	294,27	CHI
20201258742	ITAPACI	IW12123102	ITAPACI	11/12/2020 05:50	11/12/2020 10:16	11/12/2020 05:50	11/12/2020 10:16	4,43	11	48,74	CHI
20201258758	ITABERAI	IB12108138	ITABERAI S2	11/12/2020 05:50	11/12/2020 09:28	11/12/2020 05:50	11/12/2020 09:28	3,63	27	98,06	CHI
20201258768	PALMEIRAS DE GOIAS	PL12289855	ANICUNS	11/12/2020 05:50	11/12/2020 07:08	11/12/2020 05:50	11/12/2020 07:08	1,29	23	29,73	CHI
20201259303	ORIZONA	OZ12022985	PIRES DO RIO S2	11/12/2020 05:50	12/12/2020 11:13	11/12/2020 05:50	12/12/2020 11:13	29,37	5	146,87	CHI

20201258727	LAGOA SANTA	IJ12219579	CACHOEIRA ALTA	11/12/2020 05:52	11/12/2020 09:28	11/12/2020 05:52	11/12/2020 09:28	3,59	1	3,59	CHI
20201258729	DAMOLANDIA	DL12014191	INHUMAS S1	11/12/2020 05:52	11/12/2020 08:30	11/12/2020 05:52	11/12/2020 08:30	2,62	18	47,16	CHI
20201258733	FORMOSO	FO21288755	MARA ROSA	11/12/2020 05:53	11/12/2020 08:17	11/12/2020 05:53	11/12/2020 08:17	2,39	1	2,39	CHI
20201259722	MINEIROS	MY12193784	PARQUE DAS EMAS	11/12/2020 05:53	11/12/2020 10:37	11/12/2020 05:53	11/12/2020 10:37	4,73	3	14,19	CHI
20201258570	NOVO BRASIL	IU12037339	JUSSARA	11/12/2020 05:55	11/12/2020 18:17	11/12/2020 05:55	11/12/2020 18:17	12,35	1	12,35	CHI
20201258570	ITAPIRAPUA	IU12037339	JUSSARA	11/12/2020 05:55	11/12/2020 18:17	11/12/2020 05:55	11/12/2020 18:17	12,35	7	86,48	CHI
20201258737	MONTES CLAROS DE GOIAS	ME12038971	IPORA	11/12/2020 05:55	11/12/2020 11:40	11/12/2020 05:55	11/12/2020 11:40	5,74	21	120,46	CHI
20201258738	QUIRINOPOLIS	QI21316781	RIO DOS BOIS	11/12/2020 05:55	11/12/2020 15:10	11/12/2020 05:55	11/12/2020 15:10	9,23	1	9,23	CHI
20201258741	RIO VERDE	RV21226271	MONTIVIDIU T	11/12/2020 05:57	11/12/2020 09:59	11/12/2020 05:57	11/12/2020 09:59	4,03	1	4,03	CHI
20201258746	GOIANIA	10020362046	CARAJAS S2	11/12/2020 05:59	11/12/2020 08:23	11/12/2020 05:59	11/12/2020 08:23	2,39	1	2,39	CHI
20201258792	ITAPURANGA	IK12060514	ITAPURANGA	11/12/2020 05:59	11/12/2020 09:21	11/12/2020 05:59	11/12/2020 09:21	3,36	66	222,02	CHI
20201261074	MAIRIPOTABA	MI11108114	PONTALINA	11/12/2020 06:00	11/12/2020 17:08	11/12/2020 06:00	11/12/2020 17:08	11,13	48	534,17	CHI
20201259467	MARA ROSA	MQ12208421	MARA ROSA	11/12/2020 06:01	11/12/2020 11:01	11/12/2020 06:01	11/12/2020 11:01	4,99	13	64,82	CHI
20201258760	DOVERLANDIA	4220031353	CAIAPONIA	11/12/2020 06:03	11/12/2020 10:36	11/12/2020 06:03	11/12/2020 10:36	4,55	1	4,55	CHI
20201258761	CAMPINACU	UC21294023	MARA ROSA	11/12/2020 06:03	11/12/2020 09:54	11/12/2020 06:03	11/12/2020 09:54	3,83	1	3,83	CHI
20201258763	POSSE	PS12133571	IACIARA S2	11/12/2020 06:04	11/12/2020 10:31	11/12/2020 06:04	11/12/2020 10:31	4,45	4	17,79	CHI
20201258764	IPORA	IR12014557	IPORA	11/12/2020 06:04	11/12/2020 08:12	11/12/2020 06:04	11/12/2020 08:12	2,13	23	48,98	CHI
20201258766	ABADIANIA	AA21180473	CORUMBA	11/12/2020 06:04	11/12/2020 16:18	11/12/2020 06:04	11/12/2020 16:18	10,23	1	10,23	CHI
20201258815	JUSSARA	JR12011813	BRITANIA	11/12/2020 06:04	12/12/2020 16:07	11/12/2020 06:04	11/12/2020 13:22	7,30	8	58,43	CHI
20201258815	JUSSARA	JR12011813	BRITANIA	11/12/2020 06:04	12/12/2020 16:07	11/12/2020 06:04	12/12/2020 16:07	34,06	23	783,41	CHI
20201258771	ABADIANIA	AA12221425	ANAPOLIS UNIVERSITARIO S1	11/12/2020 06:06	11/12/2020 13:12	11/12/2020 06:06	11/12/2020 10:56	4,83	12	57,95	CHI
20201258771	ABADIANIA	AA12221425	ANAPOLIS UNIVERSITARIO S1	11/12/2020 06:06	11/12/2020 13:12	11/12/2020 06:06	11/12/2020 11:41	5,58	7	39,03	CHI
20201258771	ABADIANIA	AA12221425	ANAPOLIS UNIVERSITARIO S1	11/12/2020 06:06	11/12/2020 13:12	11/12/2020 06:06	11/12/2020 11:58	5,87	4	23,48	CHI
20201258771	ABADIANIA	AA12221425	ANAPOLIS UNIVERSITARIO S1	11/12/2020 06:06	11/12/2020 13:12	11/12/2020 06:06	11/12/2020 12:02	5,93	4	23,71	CHI
20201258771	ABADIANIA	AA12221425	ANAPOLIS UNIVERSITARIO S1	11/12/2020 06:06	11/12/2020 13:12	11/12/2020 06:06	11/12/2020 12:39	6,55	10	65,53	CHI
20201258771	ABADIANIA	AA12221425	ANAPOLIS UNIVERSITARIO S1	11/12/2020 06:06	11/12/2020 13:12	11/12/2020 06:06	11/12/2020 13:12	7,09	8	56,73	CHI
20201258771	GAMELEIRA DE GOIAS	AA12221425	ANAPOLIS UNIVERSITARIO S1	11/12/2020 06:06	11/12/2020 13:12	11/12/2020 06:06	11/12/2020 13:12	7,09	1	7,09	CHI
20201258772	POSSE	PS21132028	IACIARA S2	11/12/2020 06:06	11/12/2020 12:14	11/12/2020 06:06	11/12/2020 12:14	6,12	4	24,49	CHI
20201260264	NOVA IGUACU DE GOIAS	NH12375433	SANTA TEREZINHA	11/12/2020 06:07	11/12/2020 15:27	11/12/2020 06:07	11/12/2020 15:27	9,33	4	37,30	CHI
20201258779	NIQUELANDIA	NQ12268729	BARRO ALTO	11/12/2020 06:08	11/12/2020 07:44	11/12/2020 06:08	11/12/2020 07:44	1,59	63	100,38	CHI
20201258786	PIRES DO RIO	460041850	PIRES DO RIO S1	11/12/2020 06:09	11/12/2020 08:55	11/12/2020 06:09	11/12/2020 08:55	2,75	1	2,75	CHI
20201259440	INHUMAS	IN11000060	INHUMAS S2	11/12/2020 06:09	11/12/2020 08:27	11/12/2020 06:09	11/12/2020 08:27	2,29	71	162,61	CHI
20201259558	JARAGUA	JA21070657	JARAGUA	11/12/2020 06:09	12/12/2020 00:34	11/12/2020 06:09	12/12/2020 00:34	18,41	2	36,82	CHI
20201258787	VALPARAISO DE GOIAS	10026385994	MARAJOARA	11/12/2020 06:10	11/12/2020 07:40	11/12/2020 06:10	11/12/2020 07:40	1,50	1	1,50	CHI
20201258789	SAO LUIS DE MONTES BELOS	SC12019505	SAO LUIZ DOS MONTES BELOS	11/12/2020 06:10	11/12/2020 08:03	11/12/2020 06:10	11/12/2020 08:03	1,88	12	22,50	CHI
20201258969	PONTALINA	PK12182928	PONTALINA	11/12/2020 06:11	11/12/2020 10:02	11/12/2020 06:11	11/12/2020 10:02	3,84	15	57,57	CHI
20201258799	CRIXAS	CX21257337	SERRA DO OURO	11/12/2020 06:12	11/12/2020 12:52	11/12/2020 06:12	11/12/2020 12:52	6,65	1	6,65	CHI
20201258978	ANICUNS	TV12304696	FIRMINOPOLIS S2	11/12/2020 06:12	11/12/2020 09:28	11/12/2020 06:12	11/12/2020 09:28	3,26	3	9,79	CHI
20201258978	TURVANIA	TV12304696	FIRMINOPOLIS S2	11/12/2020 06:12	11/12/2020 09:28	11/12/2020 06:12	11/12/2020 09:28	3,26	15	48,93	CHI
20201258803	FAINA	FC12058296	GOIAS	11/12/2020 06:13	11/12/2020 07:31	11/12/2020 06:13	11/12/2020 07:31	1,29	3	3,88	CHI
20201259813	SILVANIA	SV12382750	DAIA S2	11/12/2020 06:13	11/12/2020 13:21	11/12/2020 06:13	11/12/2020 13:21	7,13	2	14,27	CHI
20201261672	SAO LUIZ DO NORTE	SZ12236801	BARRO ALTO	11/12/2020 06:14	11/12/2020 23:58	11/12/2020 06:14	11/12/2020 23:58	17,72	22	389,88	CHI
20201258336	URUACU	UR12278486	URUACU	11/12/2020 06:15	11/12/2020 09:40	11/12/2020 06:15	11/12/2020 09:40	3,40	9	30,63	CHI
20201259227	NIQUELANDIA	NQ12234731	NIQUELANDIA SUBTRANSMISSAO	11/12/2020 06:15	12/12/2020 10:33	11/12/2020 06:15	12/12/2020 10:33	28,30	13	367,88	CHI
20201259227	ALTO PARAISO DE GOIAS	NQ12234731	NIQUELANDIA SUBTRANSMISSAO	11/12/2020 06:15	12/12/2020 10:33	11/12/2020 06:15	12/12/2020 10:33	28,30	12	339,58	CHI
20201259227	SAO JOAO D ALIANCA	NQ12234731	NIQUELANDIA SUBTRANSMISSAO	11/12/2020 06:15	12/12/2020 10:33	11/12/2020 06:15	12/12/2020 10:33	28,30	1	28,30	CHI
20201258828	URUACU	UR12003395	URUACU	11/12/2020 06:19	11/12/2020 11:27	11/12/2020 06:19	11/12/2020 11:27	5,13	8	41,03	CHI
20201258829	GOIANIA	10654290	CAMPINAS S1	11/12/2020 06:19	11/12/2020 08:42	11/12/2020 06:19	11/12/2020 08:42	2,38	1	2,38	CHI
20201260637	ORIZONA	OZ12114547	PIRES DO RIO S2	11/12/2020 06:19	11/12/2020 12:50	11/12/2020 06:19	11/12/2020 12:50	6,51	8	52,09	CHI
20201258834	VIANOPOLIS	OZ12084921RE	PIRES DO RIO S2	11/12/2020 06:20	11/12/2020 13:24	11/12/2020 06:20	11/12/2020 13:24	7,06	17	120,02	CHI
20201258834	ORIZONA	OZ12084921RE	PIRES DO RIO S2	11/12/2020 06:20	11/12/2020 13:24	11/12/2020 06:20	11/12/2020 13:24	7,06	110	776,60	CHI

20201258860	ORIZONA	01480414	PIRES DO RIO S2	11/12/2020 06:20	11/12/2020 09:26	11/12/2020 06:20	11/12/2020 08:23	2,05	8	16,38	CHI
20201258860	PIRES DO RIO	01480414	PIRES DO RIO S2	11/12/2020 06:20	11/12/2020 09:26	11/12/2020 06:20	11/12/2020 08:23	2,05	10	20,47	CHI
20201258860	URUTAI	01480414	PIRES DO RIO S2	11/12/2020 06:20	11/12/2020 09:26	11/12/2020 06:20	11/12/2020 08:23	2,05	98	200,63	CHI
20201258860	URUTAI	01480414	PIRES DO RIO S2	11/12/2020 06:20	11/12/2020 09:26	11/12/2020 06:20	11/12/2020 09:14	2,90	6	17,38	CHI
20201258860	ORIZONA	01480414	PIRES DO RIO S2	11/12/2020 06:20	11/12/2020 09:26	11/12/2020 06:20	11/12/2020 09:14	2,90	1	2,90	CHI
20201258860	IPAMERI	01480414	PIRES DO RIO S2	11/12/2020 06:20	11/12/2020 09:26	11/12/2020 06:20	11/12/2020 09:14	2,90	10	28,96	CHI
20201258860	IPAMERI	01480414	PIRES DO RIO S2	11/12/2020 06:20	11/12/2020 09:26	11/12/2020 06:20	11/12/2020 09:26	3,10	84	260,14	CHI
20201259156	ACREUNA	EU12085776	ACREUNA	11/12/2020 06:20	11/12/2020 23:03	11/12/2020 06:20	11/12/2020 16:30	10,17	5	50,84	CHI
20201259156	ACREUNA	EU12219444LD	ACREUNA	11/12/2020 06:20	11/12/2020 23:03	11/12/2020 06:20	11/12/2020 23:03	16,72	2	33,45	CHI
20201258840	MINACU	IH11202481	MINACU	11/12/2020 06:21	11/12/2020 09:28	11/12/2020 06:21	11/12/2020 09:28	3,11	11	34,22	CHI
20201258842	GUARANI DE GOIAS	SD12262409	SAO DOMINGOS	11/12/2020 06:21	11/12/2020 11:03	11/12/2020 06:21	11/12/2020 11:03	4,69	3	14,08	CHI
20201258842	SAO DOMINGOS	SD12262409	SAO DOMINGOS	11/12/2020 06:21	11/12/2020 11:03	11/12/2020 06:21	11/12/2020 11:03	4,69	72	337,84	CHI
20201258846	ORIZONA	VN12072138	VIANOPOLIS	11/12/2020 06:22	11/12/2020 11:19	11/12/2020 06:22	11/12/2020 11:19	4,95	23	113,77	CHI
20201258846	VIANOPOLIS	VN12072138	VIANOPOLIS	11/12/2020 06:22	11/12/2020 11:19	11/12/2020 06:22	11/12/2020 11:19	4,95	88	435,28	CHI
20201258905	MARA ROSA	MQ12263046	MARA ROSA	11/12/2020 06:22	11/12/2020 08:43	11/12/2020 06:22	11/12/2020 08:43	2,35	7	16,43	CHI
20201259638	SANTA CRUZ DE GOIAS	CF12103816	CRISTIANOPOLIS	11/12/2020 06:22	11/12/2020 10:53	11/12/2020 06:22	11/12/2020 10:53	4,50	11	49,53	CHI
20201259377	GOIAS	GS12172048	GOIAS	11/12/2020 06:23	11/12/2020 10:03	11/12/2020 06:23	11/12/2020 10:03	3,66	13	47,55	CHI
20201258863	GOIATUBA	GT21087226	GOIATUBA S2	11/12/2020 06:24	11/12/2020 22:41	11/12/2020 06:24	11/12/2020 22:41	16,28	1	16,28	CHI
20201258900	ORIZONA	OZ12043232RE	PIRES DO RIO S2	11/12/2020 06:24	11/12/2020 14:28	11/12/2020 06:24	11/12/2020 14:28	8,07	51	411,32	CHI
20201258936	GUARANI DE GOIAS	GY12465246	IACIARA S1	11/12/2020 06:24	11/12/2020 12:54	11/12/2020 06:24	11/12/2020 12:54	6,49	13	84,41	CHI
20201258936	IACIARA	GY12465246	IACIARA S1	11/12/2020 06:24	11/12/2020 12:54	11/12/2020 06:24	11/12/2020 12:54	6,49	3	19,48	CHI
20201258868	FLORES DE GOIAS	FB12204157	FLORES DE GOIAS	11/12/2020 06:25	11/12/2020 10:02	11/12/2020 06:25	11/12/2020 10:02	3,61	13	46,88	CHI
20201259939	NOVA CRIXAS	CX12132683LD	SERRA DO OURO	11/12/2020 06:25	11/12/2020 12:52	11/12/2020 06:25	11/12/2020 12:52	6,44	6	38,63	CHI
20201259939	CRIXAS	CX12132683LD	SERRA DO OURO	11/12/2020 06:25	11/12/2020 12:52	11/12/2020 06:25	11/12/2020 12:52	6,44	133	856,41	CHI
20201258877	GOIANIA	I0104185	XAVANTES	11/12/2020 06:26	11/12/2020 11:38	11/12/2020 06:26	11/12/2020 11:38	5,19	1	5,19	CHI
20201259097	SANTA RITA DO NOVO DESTINO	SZ12242779	BARRO ALTO	11/12/2020 06:26	11/12/2020 23:01	11/12/2020 06:26	11/12/2020 23:01	16,58	1	16,58	CHI
20201259097	SAO LUIZ DO NORTE	SZ12242779	BARRO ALTO	11/12/2020 06:26	11/12/2020 23:01	11/12/2020 06:26	11/12/2020 23:01	16,58	8	132,61	CHI
20201259542	INDIARA	EA12056548	EDEIA	11/12/2020 06:26	11/12/2020 11:14	11/12/2020 06:26	11/12/2020 11:14	4,79	7	33,55	CHI
20201258881	CAMPINORTE	MQ12390480	MARA ROSA	11/12/2020 06:27	11/12/2020 11:34	11/12/2020 06:27	11/12/2020 11:34	5,10	1	5,10	CHI
20201258881	MARA ROSA	MQ12390480	MARA ROSA	11/12/2020 06:27	11/12/2020 11:34	11/12/2020 06:27	11/12/2020 11:34	5,10	4	20,42	CHI
20201258932	NEROPOLIS	NR12000048	NEROPOLIS S2	11/12/2020 06:28	11/12/2020 13:15	11/12/2020 06:28	11/12/2020 13:15	6,78	16	108,53	CHI
20201258887	DIORAMA	DI21135463	IPORA	11/12/2020 06:29	11/12/2020 10:14	11/12/2020 06:29	11/12/2020 10:14	3,74	1	3,74	CHI
20201258893	PORANGATU	PO12350109	PORANGATU	11/12/2020 06:30	11/12/2020 11:32	11/12/2020 06:30	11/12/2020 11:32	5,03	11	55,31	CHI
20201258273	MORRINHOS	MR12223454RE	MORRINHOS	11/12/2020 06:33	11/12/2020 10:04	11/12/2020 06:33	11/12/2020 10:04	3,51	15	52,69	CHI
20201258273	PONTALINA	MR12223454RE	MORRINHOS	11/12/2020 06:33	11/12/2020 10:04	11/12/2020 06:33	11/12/2020 10:04	3,51	5	17,56	CHI
20201258901	PIRENOPOLIS	PV21185557	CORUMBA	11/12/2020 06:33	11/12/2020 09:16	11/12/2020 06:33	11/12/2020 09:16	2,71	1	2,71	CHI
20201258902	ITARUMA	IM21303210	CACHOEIRA ALTA	11/12/2020 06:33	11/12/2020 11:33	11/12/2020 06:33	11/12/2020 11:33	4,99	2	9,98	CHI
20201258906	SITIO D ABADIA	SI12302925	IACIARA S2	11/12/2020 06:33	11/12/2020 08:03	11/12/2020 06:33	11/12/2020 08:03	1,49	3	4,46	CHI
20201258992	PALMEIRAS DE GOIAS	PL12095608	PALMEIRAS	11/12/2020 06:34	11/12/2020 08:16	11/12/2020 06:34	11/12/2020 08:16	1,70	10	16,96	CHI
20201259318	ITAPURANGA	IK12300342	ITAPURANGA	11/12/2020 06:34	11/12/2020 20:14	11/12/2020 06:34	11/12/2020 20:14	13,66	38	519,01	CHI
20201260692	ORIZONA	OZ12114504	PIRES DO RIO S2	11/12/2020 06:34	11/12/2020 12:13	11/12/2020 06:34	11/12/2020 12:13	5,65	10	56,46	CHI
20201261156	INACIOLANDIA	ID12128250	QUIRINOPOLIS	11/12/2020 06:34	11/12/2020 17:40	11/12/2020 06:34	11/12/2020 17:40	11,10	9	99,87	CHI
20201261156	BOM JESUS DE GOIAS	ID12128250	QUIRINOPOLIS	11/12/2020 06:34	11/12/2020 17:40	11/12/2020 06:34	11/12/2020 17:40	11,10	72	798,94	CHI
20201258918	ARENOPOLIS	AY12156761	ARENOPOLIS	11/12/2020 06:35	11/12/2020 09:05	11/12/2020 06:35	11/12/2020 09:05	2,49	5	12,47	CHI
20201258925	ORIZONA	OZ12127207	PIRES DO RIO S2	11/12/2020 06:36	11/12/2020 17:06	11/12/2020 06:36	11/12/2020 17:06	10,49	1	10,49	CHI
20201258929	CRISTALINA	1060019118	CRISTALINA S1	11/12/2020 06:37	11/12/2020 07:35	11/12/2020 06:37	11/12/2020 07:35	0,96	1	0,96	CHI
20201258968	GOIANIRA	GR12053239	NEROPOLIS S1	11/12/2020 06:37	11/12/2020 08:34	11/12/2020 06:37	11/12/2020 08:34	1,93	6	11,60	CHI
20201258945	PIRACANJUBA	PJ21000173	PIRACANJUBA	11/12/2020 06:40	11/12/2020 16:09	11/12/2020 06:40	11/12/2020 16:09	9,47	1	9,47	CHI
20201259009	CORUMBA DE GOIAS	PV12295561	CORUMBA	11/12/2020 06:40	11/12/2020 15:06	11/12/2020 06:40	11/12/2020 15:06	8,42	4	33,70	CHI
20201259009	PIRENOPOLIS	PV12295561	CORUMBA	11/12/2020 06:40	11/12/2020 15:06	11/12/2020 06:40	11/12/2020 15:06	8,42	31	261,16	CHI
20201258487	PIRENOPOLIS	PV12381257	CORUMBA	11/12/2020 06:41	11/12/2020 08:23	11/12/2020 06:41	11/12/2020 08:23	1,70	131	222,08	CHI

20201259392	AGUA FRIA DE GOIAS	MJ12320111	PADRE BERNARDO	11/12/2020 06:41	11/12/2020 11:03	11/12/2020 06:41	11/12/2020 11:03	4,35	9	39,18	CHI
20201258953	EDEIA	EA21283385	EDEIA	11/12/2020 06:42	11/12/2020 09:37	11/12/2020 06:42	11/12/2020 09:37	2,91	1	2,91	CHI
20201258954	PORANGATU	PO12020618	PORANGATU	11/12/2020 06:42	11/12/2020 08:46	11/12/2020 06:42	11/12/2020 08:46	2,06	25	51,58	CHI
20201258955	BELA VISTA DE GOIAS	BV31193543	BELA VISTA S1	11/12/2020 06:43	11/12/2020 08:53	11/12/2020 06:43	11/12/2020 08:53	2,17	1	2,17	CHI
20201258990	QUIRINOPOLIS	QI12052484	QUIRINOPOLIS	11/12/2020 06:43	11/12/2020 14:54	11/12/2020 06:43	11/12/2020 14:54	8,18	11	89,99	CHI
20201258971	TRINDADE	GR31055077	TRINDADE	11/12/2020 06:44	11/12/2020 08:54	11/12/2020 06:44	11/12/2020 08:54	2,15	1	2,15	CHI
20201259720	CACHOEIRA DE GOIAS	CG12206081	FIRMINOPOLIS S2	11/12/2020 06:44	11/12/2020 10:00	11/12/2020 06:44	11/12/2020 10:00	3,26	7	22,83	CHI
20201259006	PIRENOPOLIS	PV12000030	CORUMBA	11/12/2020 06:46	11/12/2020 09:57	11/12/2020 06:46	11/12/2020 09:57	3,17	20	63,47	CHI
20201259025	JARAGUA	10001449387	JARAGUA	11/12/2020 06:46	12/12/2020 03:14	11/12/2020 06:46	12/12/2020 03:14	20,46	1	20,46	CHI
20201259323	NOVA ROMA	ND12394116	IACIARA S2	11/12/2020 06:46	11/12/2020 11:53	11/12/2020 06:46	11/12/2020 11:53	5,11	5	25,55	CHI
20201259323	SAO JOAO D ALIANCA	ND12394116	IACIARA S2	11/12/2020 06:46	11/12/2020 11:53	11/12/2020 06:46	11/12/2020 11:53	5,11	15	76,66	CHI
20201259718	CAMPOS BELOS	MA12209854	SAO DOMINGOS	11/12/2020 06:46	11/12/2020 10:28	11/12/2020 06:46	11/12/2020 10:28	3,69	4	14,76	CHI
20201259718	MONTE ALEGRE DE GOIAS	MA12209854	SAO DOMINGOS	11/12/2020 06:46	11/12/2020 10:28	11/12/2020 06:46	11/12/2020 10:28	3,69	18	66,43	CHI
20201258980	RIO VERDE	JT12378104B	JATAI S2	11/12/2020 06:47	11/12/2020 08:21	11/12/2020 06:47	11/12/2020 08:21	1,56	24	37,47	CHI
20201258980	JATAI	JT12378104B	JATAI S2	11/12/2020 06:47	11/12/2020 08:21	11/12/2020 06:47	11/12/2020 08:21	1,56	133	207,66	CHI
20201259182	BOM JARDIM DE GOIAS	BM12349615	BOM JARDIM	11/12/2020 06:47	11/12/2020 09:37	11/12/2020 06:47	11/12/2020 09:37	2,82	16	45,10	CHI
20201260618	MINEIROS	MY12197099	PARQUE DAS EMAS	11/12/2020 06:47	11/12/2020 18:20	11/12/2020 06:47	11/12/2020 18:20	11,55	4	46,19	CHI
20201260618	MINEIROS	MY12197099	PARQUE DAS EMAS	11/12/2020 06:47	11/12/2020 18:20	11/12/2020 14:45	11/12/2020 18:20	3,58	5	17,90	CHI
20201258994	AVELINOPOLIS	AV12071782	ANICUNS	11/12/2020 06:48	11/12/2020 09:09	11/12/2020 06:48	11/12/2020 09:09	2,35	10	23,49	CHI
20201258994	SANTA BARBARA DE GOIAS	AV12071782	ANICUNS	11/12/2020 06:48	11/12/2020 09:09	11/12/2020 06:48	11/12/2020 09:09	2,35	8	18,79	CHI
20201258997	APARECIDA DE GOIANIA	11962951	REAL S1	11/12/2020 06:48	11/12/2020 07:55	11/12/2020 06:48	11/12/2020 07:55	1,10	1	1,10	CHI
20201259383	BARRO ALTO	BA12382485	BARRO ALTO	11/12/2020 06:48	11/12/2020 20:50	11/12/2020 06:48	11/12/2020 20:50	14,03	9	126,23	CHI
20201258998	AGUA LIMPA	AL11273798	VILA CORUMBA	11/12/2020 06:49	11/12/2020 09:22	11/12/2020 06:49	11/12/2020 09:22	2,55	24	61,18	CHI
20201258999	URUACU	UR12082989	URUACU	11/12/2020 06:49	11/12/2020 09:13	11/12/2020 06:49	11/12/2020 09:13	2,40	6	14,39	CHI
20201259100	FIRMINOPOLIS	AI12000010	FIRMINOPOLIS S2	11/12/2020 06:49	11/12/2020 09:45	11/12/2020 06:49	11/12/2020 09:45	2,93	6	17,57	CHI
20201259100	AURILANDIA	AI12000010	FIRMINOPOLIS S2	11/12/2020 06:49	11/12/2020 09:45	11/12/2020 06:49	11/12/2020 09:45	2,93	2	5,86	CHI
20201259010	MAURILANDIA	ML21046723	RIO DOS BOIS	11/12/2020 06:50	11/12/2020 10:03	11/12/2020 06:50	11/12/2020 10:03	3,21	1	3,21	CHI
20201259013	ANAPOLIS	AN11000277	JUNDIAI S2	11/12/2020 06:51	11/12/2020 09:15	11/12/2020 06:51	11/12/2020 09:15	2,40	178	426,36	CHI
20201259018	SAO MIGUEL DO ARAGUAIA	SM21060840	SAO MIGUEL DO ARAGUAIA	11/12/2020 06:51	11/12/2020 08:38	11/12/2020 06:51	11/12/2020 08:38	1,77	1	1,77	CHI
20201259603	JATAI	JT12108447	JATAI S1	11/12/2020 06:51	11/12/2020 12:39	11/12/2020 06:51	11/12/2020 12:39	5,81	7	40,66	CHI
20201259021	ARUANA	AK12015606	ARUANA	11/12/2020 06:52	11/12/2020 16:19	11/12/2020 06:52	11/12/2020 16:19	9,45	1	9,45	CHI
20201259032	CRISTALINA	KR12313552	CRISTALINA S2	11/12/2020 06:52	11/12/2020 09:13	11/12/2020 06:52	11/12/2020 09:13	2,34	28	65,63	CHI
20201259559	JARAGUA	70016318	JARAGUA	11/12/2020 06:52	11/12/2020 18:24	11/12/2020 06:52	11/12/2020 18:24	11,53	1	11,53	CHI
20201259615	FAINA	GS12274402	GOIAS	11/12/2020 06:52	11/12/2020 17:16	11/12/2020 06:52	11/12/2020 17:16	10,38	2	20,77	CHI
20201259615	GOIAS	GS12274402	GOIAS	11/12/2020 06:52	11/12/2020 17:16	11/12/2020 06:52	11/12/2020 17:16	10,38	3	31,15	CHI
20201259644	MINEIROS	MY12303867	PARQUE DAS EMAS	11/12/2020 06:52	11/12/2020 08:50	11/12/2020 06:52	11/12/2020 08:50	1,97	8	15,72	CHI
20201259894	ORIZONA	OZ12114517	PIRES DO RIO S2	11/12/2020 06:52	11/12/2020 11:39	11/12/2020 06:52	11/12/2020 11:39	4,77	23	109,77	CHI
20201259033	CRISTALINA	20333670	CRISTALINA S2	11/12/2020 06:53	11/12/2020 10:45	11/12/2020 06:53	11/12/2020 10:45	3,86	2	7,72	CHI
20201259035	TURVANIA	TV12259072	FIRMINOPOLIS S2	11/12/2020 06:53	11/12/2020 17:25	11/12/2020 06:53	11/12/2020 15:04	8,17	3	24,52	CHI
20201259035	TURVANIA	TV12259072	FIRMINOPOLIS S2	11/12/2020 06:53	11/12/2020 17:25	11/12/2020 15:38	11/12/2020 17:25	1,77	3	5,31	CHI
20201259036	PIRENOPOLIS	PV12382177	CORUMBA	11/12/2020 06:53	11/12/2020 11:36	11/12/2020 06:53	11/12/2020 11:36	4,70	6	28,21	CHI
20201259037	CAMPINORTE	CR12094178	CAMPINORTE	11/12/2020 06:53	11/12/2020 11:04	11/12/2020 06:53	11/12/2020 11:04	4,17	11	45,85	CHI
20201259150	BONOPOLIS	BX12202590	SAO MIGUEL DO ARAGUAIA	11/12/2020 06:53	11/12/2020 09:53	11/12/2020 06:53	11/12/2020 09:53	2,99	12	35,92	CHI
20201259041	SANTO ANTONIO DO DESCOBERTO	SN12389362	MARAJOARA	11/12/2020 06:55	11/12/2020 09:07	11/12/2020 06:55	11/12/2020 09:07	2,20	3	6,59	CHI
20201259047	ACREUNA	EU21301434	ACREUNA	11/12/2020 06:55	11/12/2020 11:58	11/12/2020 06:55	11/12/2020 09:59	3,06	1	3,06	CHI
20201259047	ACREUNA	EU21301434	ACREUNA	11/12/2020 06:55	11/12/2020 11:58	11/12/2020 10:02	11/12/2020 11:58	1,94	1	1,94	CHI
20201259373	CAMPINORTE	CR12161155	MARA ROSA	11/12/2020 06:55	11/12/2020 21:20	11/12/2020 06:55	11/12/2020 21:20	14,41	4	57,64	CHI
20201259373	MARA ROSA	CR12161155	MARA ROSA	11/12/2020 06:55	11/12/2020 21:20	11/12/2020 06:55	11/12/2020 21:20	14,41	5	72,04	CHI
20201259389	PADRE BERNARDO	PB12290579	PADRE BERNARDO	11/12/2020 06:55	11/12/2020 14:49	11/12/2020 06:55	11/12/2020 14:49	7,89	6	47,34	CHI
20201259048	PIRACANJUBA	PJ21316657	ROCHEDO	11/12/2020 06:56	11/12/2020 13:20	11/12/2020 06:56	11/12/2020 13:20	6,39	1	6,39	CHI
20201259051	PONTALINA	PK21204425	PONTALINA	11/12/2020 06:57	11/12/2020 12:33	11/12/2020 06:57	11/12/2020 12:33	5,60	2	11,19	CHI

20201259053	NIQUELANDIA	NQ12315489	BARRO ALTO	11/12/2020 06:57	11/12/2020 18:23	11/12/2020 06:57	11/12/2020 18:23	11,42	1	11,42	CHI
20201259099	ITAPURANGA	IK12300247	ITAPURANGA	11/12/2020 06:57	11/12/2020 11:21	11/12/2020 06:57	11/12/2020 11:21	4,39	6	26,32	CHI
20201259099	FAINA	IK12300247	ITAPURANGA	11/12/2020 06:57	11/12/2020 11:21	11/12/2020 06:57	11/12/2020 11:21	4,39	27	118,42	CHI
20201259064	CORREGO DO OURO	CO11099399	SAO LUIZ DOS MONTES BELOS	11/12/2020 07:00	11/12/2020 08:53	11/12/2020 07:00	11/12/2020 08:53	1,87	14	26,19	CHI
20201259066	TURVANIA	TV21111592	FIRMINOPOLIS S1	11/12/2020 07:00	11/12/2020 09:39	11/12/2020 07:00	11/12/2020 09:39	2,63	1	2,63	CHI
20201259481	CACHOEIRA ALTA	CA12371215	CACHOEIRA ALTA	11/12/2020 07:00	11/12/2020 10:57	11/12/2020 07:00	11/12/2020 10:57	3,93	22	86,56	CHI
20201259072	ITARUMA	IM21033233	CACHOEIRA ALTA	11/12/2020 07:01	11/12/2020 11:51	11/12/2020 07:01	11/12/2020 11:51	4,82	2	9,64	CHI
20201259260	MARA ROSA	MQ12318474	SANTA TEREZINHA	11/12/2020 07:01	11/12/2020 14:56	11/12/2020 07:01	11/12/2020 14:56	7,92	6	47,50	CHI
20201259378	ITAPURANGA	IK12298409	ITAPURANGA	11/12/2020 07:01	11/12/2020 12:24	11/12/2020 07:01	11/12/2020 12:24	5,37	14	75,15	CHI
20201261043	JARAGUA	JA12414669	JARAGUA	11/12/2020 07:01	11/12/2020 12:31	11/12/2020 07:01	11/12/2020 12:31	5,51	222	1222,54	CHI
20201259074	NOVA CRIXAS	NA12349203	NOVA CRIXAS	11/12/2020 07:02	11/12/2020 21:04	11/12/2020 07:02	11/12/2020 21:04	14,03	3	42,09	CHI
20201259085	SILVANIA	SV21284598	DAIA S2	11/12/2020 07:03	11/12/2020 10:20	11/12/2020 07:03	11/12/2020 10:20	3,28	1	3,28	CHI
20201259087	GAMELEIRA DE GOIAS	SV12116679	DAIA S2	11/12/2020 07:03	11/12/2020 09:35	11/12/2020 07:03	11/12/2020 09:35	2,52	16	40,35	CHI
20201259087	SILVANIA	SV12116679	DAIA S2	11/12/2020 07:03	11/12/2020 09:35	11/12/2020 07:03	11/12/2020 09:35	2,52	6	15,13	CHI
20201259089	CALDAZINHA	LB21187214	DAIA S2	11/12/2020 07:04	11/12/2020 09:22	11/12/2020 07:04	11/12/2020 09:22	2,30	1	2,30	CHI
20201259573	GOIANIA	AP11167074	ATLANTICO S2	11/12/2020 07:04	11/12/2020 09:26	11/12/2020 07:04	11/12/2020 09:26	2,36	16	37,70	CHI
20201259892	PETROLINA DE GOIAS	PG12011518	PETROLINA	11/12/2020 07:04	11/12/2020 12:56	11/12/2020 07:04	11/12/2020 12:56	5,85	10	58,54	CHI
20201259098	NIQUELANDIA	NQ10375673	NIQUELANDIA SUBTRANSMISSAO	11/12/2020 07:05	13/12/2020 16:57	11/12/2020 11:27	11/12/2020 12:35	1,14	287	326,38	CHI
20201259098	NIQUELANDIA	NQ12262925RE	NIQUELANDIA SUBTRANSMISSAO	11/12/2020 07:05	13/12/2020 16:57	11/12/2020 07:05	12/12/2020 11:55	28,83	37	1066,85	CHI
20201259098	NIQUELANDIA	NQ13243363	NIQUELANDIA SUBTRANSMISSAO	11/12/2020 07:05	13/12/2020 16:57	11/12/2020 07:05	13/12/2020 13:46	54,68	18	984,32	CHI
20201259098	NIQUELANDIA	NQ12262925RE	NIQUELANDIA SUBTRANSMISSAO	11/12/2020 07:05	13/12/2020 16:57	13/12/2020 14:01	13/12/2020 16:57	2,93	55	161,32	CHI
20201259148	CACU	CC11194916	CACHOEIRA ALTA	11/12/2020 07:06	11/12/2020 12:45	11/12/2020 07:06	11/12/2020 12:45	5,64	132	743,97	CHI
20201259111	PONTALINA	PK21108787	GOIATUBA S1	11/12/2020 07:07	11/12/2020 17:24	11/12/2020 07:07	11/12/2020 17:24	10,27	1	10,27	CHI
20201259231	MARA ROSA	MQ12120038	MARA ROSA	11/12/2020 07:07	11/12/2020 09:55	11/12/2020 07:07	11/12/2020 09:55	2,80	2	5,59	CHI
20201259113	NOVA ROMA	ND21325876	FLORES DE GOIAS	11/12/2020 07:08	11/12/2020 10:04	11/12/2020 07:08	11/12/2020 10:04	2,92	2	5,84	CHI
20201259123	PARAUNA	PU21103346	FIRMINOPOLIS S2	11/12/2020 07:09	11/12/2020 11:50	11/12/2020 07:09	11/12/2020 11:50	4,68	1	4,68	CHI
20201259129	JUSSARA	JR21073389	BRITANIA	11/12/2020 07:09	11/12/2020 17:32	11/12/2020 07:09	11/12/2020 17:32	10,38	1	10,38	CHI
20201259561	JARAGUA	JA12194298	JARAGUA	11/12/2020 07:09	12/12/2020 00:34	11/12/2020 07:09	12/12/2020 00:34	17,40	2	34,81	CHI
20201259563	JUSSARA	JR12024844	JUSSARA	11/12/2020 07:09	11/12/2020 10:09	11/12/2020 07:09	11/12/2020 10:09	2,99	54	161,41	CHI
20201259131	LUZIANIA	LZ11349070	MARAJOARA	11/12/2020 07:10	11/12/2020 08:53	11/12/2020 07:10	11/12/2020 08:53	1,71	14	23,95	CHI
20201259133	URUACU	CR12181484RE	MARA ROSA	11/12/2020 07:10	11/12/2020 13:56	11/12/2020 07:10	11/12/2020 13:56	6,76	10	67,55	CHI
20201259140	ARUANA	AK12341206	BRITANIA	11/12/2020 07:10	11/12/2020 11:37	11/12/2020 07:10	11/12/2020 11:37	4,45	6	26,70	CHI
20201259828	PANAMA	PX12000436	ITUMBIARA NOVA	11/12/2020 07:11	11/12/2020 17:26	11/12/2020 07:11	11/12/2020 17:26	10,24	35	358,52	CHI
20201259142	ITABERAI	IX13016072	INHUMAS S1	11/12/2020 07:12	11/12/2020 16:03	11/12/2020 07:12	11/12/2020 16:03	8,84	14	123,83	CHI
20201259142	ITAUCU	IX13016072	INHUMAS S1	11/12/2020 07:12	11/12/2020 16:03	11/12/2020 07:12	11/12/2020 16:03	8,84	275	2432,30	CHI
20201259142	ITABERAI	IX13016072	INHUMAS S1	11/12/2020 07:12	11/12/2020 16:03	11/12/2020 13:50	11/12/2020 16:03	2,22	18	39,90	CHI
20201259142	ITAUCU	IX13016072	INHUMAS S1	11/12/2020 07:12	11/12/2020 16:03	11/12/2020 13:50	11/12/2020 16:03	2,22	12	26,60	CHI
20201259144	CRISTALINA	KR21133632	CRISTALINA S2	11/12/2020 07:12	11/12/2020 14:05	11/12/2020 07:12	11/12/2020 14:05	6,87	1	6,87	CHI
20201259163	LUZIANIA	LZ12330594	CRISTALINA S2	11/12/2020 07:12	11/12/2020 12:07	11/12/2020 07:12	11/12/2020 12:07	4,92	10	49,17	CHI
20201259163	LUZIANIA	LZ12330594	CRISTALINA S2	11/12/2020 07:12	11/12/2020 12:07	11/12/2020 09:20	11/12/2020 12:07	2,80	5	13,99	CHI
20201260000	FORMOSO	ET12168852	MARA ROSA	11/12/2020 07:12	11/12/2020 13:06	11/12/2020 07:12	11/12/2020 13:06	5,90	2	11,80	CHI
20201260000	ESTRELA DO NORTE	ET12168852	MARA ROSA	11/12/2020 07:12	11/12/2020 13:06	11/12/2020 07:12	11/12/2020 13:06	5,90	4	23,59	CHI
20201259152	ITAUCU	IX12322432	INHUMAS S1	11/12/2020 07:14	11/12/2020 19:48	11/12/2020 07:14	11/12/2020 19:48	12,57	6	75,39	CHI
20201259153	BONOPOLIS	BX12364615	SAO MIGUEL DO ARAGUAIA	11/12/2020 07:14	11/12/2020 07:40	11/12/2020 07:14	11/12/2020 07:40	0,43	19	8,16	CHI
20201259345	MOZARLANDIA	MZ12055640	MOZARLANDIA	11/12/2020 07:14	11/12/2020 10:50	11/12/2020 07:14	11/12/2020 10:50	3,60	9	32,36	CHI
20201259670	FAZENDA NOVA	JR12362437	BRITANIA	11/12/2020 07:15	11/12/2020 09:53	11/12/2020 07:15	11/12/2020 09:53	2,62	3	7,85	CHI
20201259670	JUSSARA	JR12362437	BRITANIA	11/12/2020 07:15	11/12/2020 09:53	11/12/2020 07:15	11/12/2020 09:53	2,62	7	18,32	CHI
20201259166	APARECIDA DE GOIANIA	AP11123586	INDEPENDENCIA S1	11/12/2020 07:16	11/12/2020 15:09	11/12/2020 11:21	11/12/2020 15:09	3,80	153	581,40	CHI
20201259167	VILA PROPICIO	NP21235929	GOIANESIA S1	11/12/2020 07:16	11/12/2020 12:16	11/12/2020 07:16	11/12/2020 12:16	4,99	2	9,97	CHI
20201259254	LEOPOLDO DE BULHOES	LB12353165	DAIA S2	11/12/2020 07:16	11/12/2020 19:59	11/12/2020 07:16	11/12/2020 19:59	12,72	14	178,01	CHI
20201259176	ITARUMA	IM12303219	CACHOEIRA ALTA	11/12/2020 07:18	11/12/2020 10:56	11/12/2020 07:18	11/12/2020 10:56	3,63	2	7,26	CHI

20201259176	ITAJA	IM12303219	CACHOEIRA ALTA	11/12/2020 07:18	11/12/2020 10:56	11/12/2020 07:18	11/12/2020 10:56	3,63	5	18,14	CHI
20201259190	SAO MIGUEL DO ARAGUAIA	SM11248546	SAO MIGUEL DO ARAGUAIA	11/12/2020 07:18	11/12/2020 11:25	11/12/2020 07:18	11/12/2020 11:25	4,12	116	477,47	CHI
20201259534	MINACU	IH12230499	MINACU	11/12/2020 07:18	12/12/2020 08:19	11/12/2020 07:18	12/12/2020 08:19	25,01	50	1250,44	CHI
20201260047	PONTALINA	PK12234562	PONTALINA	11/12/2020 07:18	11/12/2020 11:14	11/12/2020 07:18	11/12/2020 11:14	3,92	3	11,76	CHI
20201260547	PORANGATU	MU12192418	MARA ROSA	11/12/2020 07:18	11/12/2020 14:30	11/12/2020 07:18	11/12/2020 14:30	7,20	1	7,20	CHI
20201260547	AMARALINA	MU12192418	MARA ROSA	11/12/2020 07:18	11/12/2020 14:30	11/12/2020 07:18	11/12/2020 14:30	7,20	1	7,20	CHI
20201259186	AMARALINA	LC12216163	MARA ROSA	11/12/2020 07:19	11/12/2020 10:53	11/12/2020 07:19	11/12/2020 10:53	3,56	5	17,80	CHI
20201259766	FORMOSA	FA12106874	ITUIQUIRA	11/12/2020 07:19	11/12/2020 11:41	11/12/2020 07:19	11/12/2020 11:41	4,36	18	78,40	CHI
20201259194	MINEIROS	10012008905	PARQUE DAS EMAS	11/12/2020 07:20	11/12/2020 21:20	11/12/2020 07:20	11/12/2020 21:20	13,98	1	13,98	CHI
20201259198	ABADIANIA	350018030	ANAPOLIS UNIVERSITARIO S1	11/12/2020 07:21	11/12/2020 19:31	11/12/2020 07:21	11/12/2020 19:31	12,17	1	12,17	CHI
20201259201	AURILANDIA	1010009701	FIRMINOPOLIS S2	11/12/2020 07:23	11/12/2020 10:48	11/12/2020 07:23	11/12/2020 10:48	3,42	1	3,42	CHI
20201259206	LUZIANIA	LZ12389578	VIANOPOLIS	11/12/2020 07:23	11/12/2020 09:05	11/12/2020 07:23	11/12/2020 09:05	1,69	19	32,04	CHI
20201259224	GOIAS	GS12162480LD	GOIAS	11/12/2020 07:23	11/12/2020 11:37	11/12/2020 07:23	11/12/2020 11:37	4,22	43	181,57	CHI
20201259208	ALTO PARAISO DE GOIAS	BF21163462	FLORES DE GOIAS	11/12/2020 07:24	11/12/2020 08:11	11/12/2020 07:24	11/12/2020 08:11	0,78	1	0,78	CHI
20201259210	ORIZONA	OZ21189415	PIRES DO RIO S2	11/12/2020 07:24	11/12/2020 14:09	11/12/2020 07:24	11/12/2020 14:09	6,74	1	6,74	CHI
20201259211	SANTO ANTONIO DA BARRA	RV21106351	ACREUNA	11/12/2020 07:24	11/12/2020 13:01	11/12/2020 07:24	11/12/2020 13:01	5,61	1	5,61	CHI
20201259215	PIRANHAS	PH21343547	CAIAPONIA	11/12/2020 07:25	11/12/2020 10:41	11/12/2020 07:25	11/12/2020 10:41	3,27	1	3,27	CHI
20201259217	GOIANIA	13703262	CARAJAS S1	11/12/2020 07:25	11/12/2020 09:39	11/12/2020 07:25	11/12/2020 09:39	2,23	1	2,23	CHI
20201259223	SILVANIA	SV21012105	BELA VISTA S2	11/12/2020 07:25	11/12/2020 12:05	11/12/2020 07:25	11/12/2020 12:05	4,65	2	9,31	CHI
20201259232	INHUMAS	IN12374035	INHUMAS S2	11/12/2020 07:27	11/12/2020 18:49	11/12/2020 07:27	11/12/2020 18:49	11,36	3	34,08	CHI
20201259235	JARAGUA	JA21354411	JARAGUA	11/12/2020 07:27	11/12/2020 16:56	11/12/2020 07:27	11/12/2020 16:56	9,47	1	9,47	CHI
20201259237	AGUAS LINDAS DE GOIAS	10018923915	AGUAS LINDAS DE GOIAS S1	11/12/2020 07:27	11/12/2020 09:09	11/12/2020 07:27	11/12/2020 09:09	1,68	1	1,68	CHI
20201259238	ANAPOLIS	20683935	ANAPOLIS UNIVERSITARIO S1	11/12/2020 07:28	11/12/2020 08:35	11/12/2020 07:28	11/12/2020 08:35	1,12	1	1,12	CHI
20201259240	PADRE BERNARDO	PB12163212	PADRE BERNARDO	11/12/2020 07:28	11/12/2020 09:04	11/12/2020 07:28	11/12/2020 09:04	1,60	30	47,88	CHI
20201259243	CRISTALINA	KR11170188	CRISTALINA S1	11/12/2020 07:28	11/12/2020 08:06	11/12/2020 07:28	11/12/2020 08:06	0,62	20	12,34	CHI
20201259405	SERRANOPOLIS	SX12166103	JATAI S1	11/12/2020 07:28	11/12/2020 23:00	11/12/2020 07:28	11/12/2020 23:00	15,53	5	77,63	CHI
20201260520	POSSE	PS12184932	IACIARA S2	11/12/2020 07:30	11/12/2020 13:47	11/12/2020 07:30	11/12/2020 13:47	6,27	5	31,34	CHI
20201259250	TURVANIA	TV21005602	FIRMINOPOLIS S1	11/12/2020 07:31	11/12/2020 09:25	11/12/2020 07:31	11/12/2020 09:25	1,90	1	1,90	CHI
20201259253	HIDROLINA	HL21346784	ITAPACI	11/12/2020 07:31	11/12/2020 11:26	11/12/2020 07:31	11/12/2020 11:26	3,90	1	3,90	CHI
20201259258	ALTO HORIZONTE	GG12150758	SANTA TEREZINHA	11/12/2020 07:32	11/12/2020 12:55	11/12/2020 07:32	11/12/2020 12:55	5,38	9	48,38	CHI
20201259263	CAMPO ALEGRE DE GOIAS	CM21066305	CAMPO ALEGRE DE GOIAS	11/12/2020 07:32	11/12/2020 10:14	11/12/2020 07:32	11/12/2020 10:14	2,69	1	2,69	CHI
20201259264	FAINA	FC21299843	GOIAS	11/12/2020 07:33	11/12/2020 10:23	11/12/2020 07:33	11/12/2020 10:23	2,83	1	2,83	CHI
20201259265	SILVANIA	SV12385027	VIANOPOLIS	11/12/2020 07:33	11/12/2020 10:38	11/12/2020 07:33	11/12/2020 10:38	3,08	1	3,08	CHI
20201259268	GOIANESIA	BA12036611LD	GOIANESIA S1	11/12/2020 07:33	11/12/2020 09:07	11/12/2020 07:33	11/12/2020 09:07	1,56	7	10,93	CHI
20201259269	GOIANIA	14382600	MEIA PONTE	11/12/2020 07:33	11/12/2020 09:14	11/12/2020 07:33	11/12/2020 09:14	1,68	1	1,68	CHI
20201259401	PEROLANDIA	DP12182220	JATAI S1	11/12/2020 07:33	11/12/2020 09:14	11/12/2020 07:33	11/12/2020 09:14	1,67	7	11,68	CHI
20201260221	GOIANIA	GN11002297	ATLANTICO S3	11/12/2020 07:33	11/12/2020 12:37	11/12/2020 07:33	11/12/2020 12:37	5,06	155	784,69	CHI
20201259278	ORIZONA	OZ12390431	PIRES DO RIO S2	11/12/2020 07:34	12/12/2020 11:13	12/12/2020 08:36	12/12/2020 11:13	2,62	24	62,78	CHI
20201259281	APARECIDA DE GOIANIA	16527227	INDEPENDENCIA S1	11/12/2020 07:34	11/12/2020 09:51	11/12/2020 07:34	11/12/2020 09:51	2,27	1	2,27	CHI
20201259282	JATAI	JT21216543	JATAI S1	11/12/2020 07:34	11/12/2020 19:31	11/12/2020 07:34	11/12/2020 19:31	11,94	1	11,94	CHI
20201259283	ALTO PARAISO DE GOIAS	BF12365282	SAO JOAO D ALIANCA	11/12/2020 07:34	11/12/2020 10:47	11/12/2020 07:34	11/12/2020 10:47	3,20	47	150,47	CHI
20201259647	ITAPURANGA	IK12299311	ITAPURANGA	11/12/2020 07:34	11/12/2020 14:51	11/12/2020 07:34	11/12/2020 14:51	7,27	109	792,52	CHI
20201259284	PADRE BERNARDO	PB12330893	PADRE BERNARDO	11/12/2020 07:35	11/12/2020 11:51	11/12/2020 07:35	11/12/2020 11:51	4,26	4	17,03	CHI
20201259286	POSSE	PS21124636	IACIARA S2	11/12/2020 07:35	11/12/2020 19:46	11/12/2020 07:35	11/12/2020 19:46	12,17	1	12,17	CHI
20201259288	CIDADE OCIDENTAL	2680026221	MARAJOARA	11/12/2020 07:35	11/12/2020 10:00	11/12/2020 07:35	11/12/2020 10:00	2,40	1	2,40	CHI
20201260002	SAO DOMINGOS	SD12218836	SAO DOMINGOS	11/12/2020 07:35	11/12/2020 12:16	11/12/2020 07:35	11/12/2020 12:16	4,67	20	93,48	CHI
20201259291	GOIANIA	13799903	GOIANIA LESTE S3	11/12/2020 07:36	11/12/2020 09:09	11/12/2020 07:36	11/12/2020 09:09	1,54	1	1,54	CHI
20201259292	BRAZABRANTES	10015139547	NEROPOLIS S1	11/12/2020 07:36	11/12/2020 10:58	11/12/2020 07:36	11/12/2020 10:58	3,35	1	3,35	CHI
20201259532	PADRE BERNARDO	PB12283786	PADRE BERNARDO	11/12/2020 07:36	11/12/2020 09:17	11/12/2020 07:36	11/12/2020 09:17	1,68	9	15,13	CHI
20201259393	MUNDO NOVO DE GOIAS	NA10396027	NOVA CRIXAS	11/12/2020 07:37	11/12/2020 07:48	11/12/2020 07:43	11/12/2020 07:48	0,09	37	3,34	CHI
20201259393	NOVA CRIXAS	NA10396027	NOVA CRIXAS	11/12/2020 07:37	11/12/2020 07:48	11/12/2020 07:43	11/12/2020 07:48	0,09	157	14,17	CHI

20201259297	VILA PROPICIO	NP21309713	GOIANESIA S1	11/12/2020 07:38	11/12/2020 11:41	11/12/2020 07:38	11/12/2020 11:41	4,05	1	4,05	CHI
20201259300	ALEXANIA	AX21090450	ALEXANIA	11/12/2020 07:38	11/12/2020 09:00	11/12/2020 07:38	11/12/2020 09:00	1,36	1	1,36	CHI
20201259305	CACHOEIRA ALTA	CA12075141	CACHOEIRA ALTA	11/12/2020 07:38	11/12/2020 09:33	11/12/2020 07:38	11/12/2020 09:33	1,92	9	17,27	CHI
20201260333	GUAPO	GA32098714	GUAPO S2	11/12/2020 07:38	11/12/2020 11:47	11/12/2020 07:38	11/12/2020 11:47	4,14	7	28,99	CHI
20201259310	VIANOPOLIS	VN21105522	VIANOPOLIS	11/12/2020 07:39	11/12/2020 10:42	11/12/2020 07:39	11/12/2020 10:42	3,04	1	3,04	CHI
20201259311	PALMEIRAS DE GOIAS	PL12233331	PALMEIRAS	11/12/2020 07:39	11/12/2020 10:20	11/12/2020 07:39	11/12/2020 10:20	2,67	7	18,69	CHI
20201259671	MATRINCHA	MP12122364	MATRINCHA	11/12/2020 07:39	11/12/2020 21:28	11/12/2020 07:39	11/12/2020 21:28	13,81	11	151,96	CHI
20201259326	QUIRINOPOLIS	QI12226698	SANTA HELENA S1	11/12/2020 07:42	11/12/2020 10:15	11/12/2020 07:42	11/12/2020 10:15	2,54	6	15,21	CHI
20201259329	CRISTALINA	KR21219771	CRISTALINA S2	11/12/2020 07:42	11/12/2020 08:33	11/12/2020 07:42	11/12/2020 08:33	0,83	1	0,83	CHI
20201259757	PARAUNA	PU12081329	PARAUNA	11/12/2020 07:42	11/12/2020 10:36	11/12/2020 07:42	11/12/2020 10:36	2,89	69	199,26	CHI
20201260371	GOIAS	GS12250577	GOIAS	11/12/2020 07:42	11/12/2020 15:19	11/12/2020 07:42	11/12/2020 15:19	7,61	9	68,47	CHI
20201259330	TRINDADE	TR12001811	GOYA S1	11/12/2020 07:43	11/12/2020 10:12	11/12/2020 07:43	11/12/2020 10:12	2,48	9	22,34	CHI
20201259331	ITAPACI	IW21094097	ITAPACI	11/12/2020 07:43	11/12/2020 10:17	11/12/2020 07:43	11/12/2020 10:17	2,56	2	5,13	CHI
20201259333	SANTA RITA DO ARAGUAIA	Z130004447	SANTA RITA DO ARAGUAIA	11/12/2020 07:43	12/12/2020 09:25	11/12/2020 07:43	12/12/2020 09:25	25,70	1	25,70	CHI
202012179351	ORIZONA	OZ21339350	PIRES DO RIO S2	11/12/2020 07:43	12/12/2020 11:13	11/12/2020 07:43	12/12/2020 11:13	27,50	1	27,50	CHI
20201259338	INACIOLANDIA	ID31128281	QUIRINOPOLIS	11/12/2020 07:44	11/12/2020 13:56	11/12/2020 07:44	11/12/2020 13:56	6,19	1	6,19	CHI
20201259919	ITAPIRAPUA	IU12206870	MATRINCHA	11/12/2020 07:44	11/12/2020 12:53	11/12/2020 07:44	11/12/2020 12:53	5,15	8	41,21	CHI
20201259343	CACU	CC21298885	CACHOEIRA ALTA	11/12/2020 07:45	11/12/2020 12:58	11/12/2020 07:45	11/12/2020 12:58	5,21	1	5,21	CHI
20201259867	ORIZONA	OZ12143761	PIRES DO RIO S2	11/12/2020 07:45	11/12/2020 14:21	11/12/2020 07:45	11/12/2020 14:21	6,59	9	59,34	CHI
20201259350	CATALAO	CT21231544	CATALAO S1	11/12/2020 07:46	11/12/2020 17:21	11/12/2020 07:46	11/12/2020 17:21	9,58	1	9,58	CHI
20201259364	ITAJA	IJ12359424	CACHOEIRA ALTA	11/12/2020 07:46	11/12/2020 18:45	11/12/2020 07:46	11/12/2020 18:45	10,97	13	142,66	CHI
20201259583	PIRACANJUBA	PJ12249778	MORRINHOS	11/12/2020 07:46	11/12/2020 11:35	11/12/2020 07:46	11/12/2020 11:35	3,81	10	38,09	CHI
20201259356	MINACU	IH12392286	MINACU	11/12/2020 07:47	11/12/2020 16:22	11/12/2020 07:47	11/12/2020 16:22	8,58	22	188,83	CHI
20201259361	MINACU	IH21236060	MINACU	11/12/2020 07:47	11/12/2020 22:55	11/12/2020 07:47	11/12/2020 22:55	15,12	1	15,12	CHI
20201260046	GOIATUBA	GT11190951	GOIATUBA S2	11/12/2020 07:47	11/12/2020 12:08	11/12/2020 07:47	11/12/2020 12:08	4,34	79	342,77	CHI
20201259374	SAO JOAO D ALIANCA	3840029180	SAO JOAO D ALIANCA	11/12/2020 07:49	11/12/2020 09:25	11/12/2020 07:49	11/12/2020 09:25	1,59	1	1,59	CHI
20201259375	FAZENDA NOVA	FN12013300	FIRMINOPOLIS S2	11/12/2020 07:49	11/12/2020 12:05	11/12/2020 07:49	11/12/2020 12:05	4,26	9	38,30	CHI
20201259380	PORTELANDIA	PW12103070	PARQUE DAS EMAS	11/12/2020 07:50	11/12/2020 13:32	11/12/2020 07:50	11/12/2020 13:32	5,70	1	5,70	CHI
20201259434	MAIRIPOTABA	CQ12000222	PONTALINA	11/12/2020 07:50	11/12/2020 15:40	11/12/2020 07:50	11/12/2020 15:40	7,83	2	15,66	CHI
20201259434	CROMINIA	CQ12000222	PONTALINA	11/12/2020 07:50	11/12/2020 15:40	11/12/2020 07:50	11/12/2020 15:40	7,83	7	54,79	CHI
20201259403	GOIATUBA	GT12295929	RIO DOS BOIS	11/12/2020 07:52	11/12/2020 11:00	11/12/2020 07:52	11/12/2020 11:00	3,13	2	6,25	CHI
20201259412	JESUPOLIS	SF21131238	SAO FRANCISCO DE GOIAS	11/12/2020 07:53	11/12/2020 12:39	11/12/2020 07:53	11/12/2020 12:39	4,76	3	14,28	CHI
20201259429	PORANGATU	PO12390255	PORANGATU	11/12/2020 07:53	11/12/2020 09:56	11/12/2020 07:53	11/12/2020 09:56	2,05	4	8,18	CHI
20201259436	PIRES DO RIO	PR12172825	PIRES DO RIO S1	11/12/2020 07:53	11/12/2020 10:19	11/12/2020 07:53	11/12/2020 10:19	2,42	13	31,48	CHI
20201259417	PILAR DE GOIAS	GG21286359	URUACU	11/12/2020 07:54	11/12/2020 15:20	11/12/2020 07:54	11/12/2020 15:20	7,43	1	7,43	CHI
20201259419	ITAPIRAPUA	10022167321	MATRINCHA	11/12/2020 07:54	11/12/2020 15:55	11/12/2020 07:54	11/12/2020 15:55	8,01	1	8,01	CHI
20201259420	APARECIDA DE GOIANIA	AP11164428	ATLANTICO S2	11/12/2020 07:54	11/12/2020 10:11	11/12/2020 07:54	11/12/2020 10:11	2,28	117	266,30	CHI
20201259421	SAO MIGUEL DO ARAGUAIA	SM12263051	SAO MIGUEL DO ARAGUAIA	11/12/2020 07:54	14/12/2020 02:53	11/12/2020 07:54	11/12/2020 21:32	13,63	1	13,63	CHI
20201259421	SAO MIGUEL DO ARAGUAIA	SM12263052LD	SAO MIGUEL DO ARAGUAIA	11/12/2020 07:54	14/12/2020 02:53	11/12/2020 07:54	14/12/2020 02:53	66,98	1	66,98	CHI
20201259422	CALDAS NOVAS	CN12000046	CALDAS NOVAS S2	11/12/2020 07:54	11/12/2020 10:35	11/12/2020 07:54	11/12/2020 10:35	2,67	13	34,75	CHI
20201259424	GOIANESIA	GE12384159	GOIANESIA S2	11/12/2020 07:54	11/12/2020 11:45	11/12/2020 07:54	11/12/2020 11:45	3,84	1	3,84	CHI
20201259433	GOIAS	GS12027672	MATRINCHA	11/12/2020 07:55	11/12/2020 19:56	11/12/2020 07:55	11/12/2020 19:56	12,00	1	12,00	CHI
20201259443	GOIANIRA	BW12291579	NEROPOLIS S1	11/12/2020 07:55	11/12/2020 18:34	11/12/2020 07:55	11/12/2020 18:34	10,64	3	31,93	CHI
20201259443	SANTO ANTONIO DE GOIAS	BW12291579	NEROPOLIS S1	11/12/2020 07:55	11/12/2020 18:34	11/12/2020 07:55	11/12/2020 18:34	10,64	2	21,29	CHI
20201259437	ITUMBIARA	IT11081096	ITUMBIARA NOVA	11/12/2020 07:56	11/12/2020 09:20	11/12/2020 07:56	11/12/2020 09:20	1,39	142	197,54	CHI
20201259441	ARAGUAPAZ	1780005328	MOZARLANDIA	11/12/2020 07:57	11/12/2020 09:36	11/12/2020 07:57	11/12/2020 09:36	1,64	1	1,64	CHI
20201259444	NOVA CRIXAS	NA12205489	NOVA CRIXAS	11/12/2020 07:57	11/12/2020 15:56	11/12/2020 07:57	11/12/2020 15:56	7,97	2	15,94	CHI
20201259446	PIRACANJUBA	PJ21106690	CALDAS NOVAS S1	11/12/2020 07:58	12/12/2020 09:54	11/12/2020 07:58	12/12/2020 09:54	25,93	2	51,86	CHI
20201259451	EDEIA	EA12160409	VICENTINOPOLIS	11/12/2020 07:58	11/12/2020 22:42	11/12/2020 07:58	11/12/2020 22:42	14,72	21	309,15	CHI
20201259453	PIRENOPOLIS	ZN21185646	COCALZINHO	11/12/2020 07:58	11/12/2020 18:06	11/12/2020 07:58	11/12/2020 18:06	10,12	2	20,24	CHI
20201259455	GOIAS	GS12203896	ITABERAI S2	11/12/2020 07:58	11/12/2020 11:52	11/12/2020 07:58	11/12/2020 11:52	3,89	40	155,72	CHI

20201259457	PETROLINA DE GOIAS	PG21071671	PETROLINA	11/12/2020 07:58	11/12/2020 17:51	11/12/2020 07:58	11/12/2020 17:51	9,87	2	19,74	CHI
20201259838	MINACU	IH12220633	MINACU	11/12/2020 07:58	13/12/2020 11:14	11/12/2020 07:58	13/12/2020 11:14	51,28	22	1128,17	CHI
20201260052	GOUVELANDIA	GB12029096	QUIRINOPOLIS	11/12/2020 07:58	11/12/2020 10:51	11/12/2020 07:58	11/12/2020 10:51	2,87	392	1125,26	CHI
20201259465	NIQUELANDIA	NQ12262919	NIQUELANDIA SUBTRANSMISSAO	11/12/2020 08:00	11/12/2020 09:55	11/12/2020 08:00	11/12/2020 09:55	1,91	10	19,14	CHI
20201259479	CALDAS NOVAS	CN12311850	RIO QUENTE	11/12/2020 08:01	11/12/2020 13:27	11/12/2020 08:01	11/12/2020 13:27	5,42	3	16,25	CHI
20201259479	MORRINHOS	CN12311850	RIO QUENTE	11/12/2020 08:01	11/12/2020 13:27	11/12/2020 08:01	11/12/2020 13:27	5,42	3	16,25	CHI
20201259482	SILVANIA	LZ12009166	VIANOPOLIS	11/12/2020 08:02	11/12/2020 11:55	11/12/2020 08:02	11/12/2020 11:55	3,88	4	15,51	CHI
20201259483	INDIARA	IY21312419	CEZARINA	11/12/2020 08:02	11/12/2020 11:02	11/12/2020 08:02	11/12/2020 11:02	2,99	1	2,99	CHI
20201259484	FORMOSA	FA12033492	SAO JOAO D ALIANCA	11/12/2020 08:02	11/12/2020 12:00	11/12/2020 08:02	11/12/2020 12:00	3,96	3	11,88	CHI
20201258886	GOIANIA	GN11047750	ATLANTICO S3	11/12/2020 08:03	11/12/2020 11:53	11/12/2020 08:03	11/12/2020 11:53	3,83	25	95,65	CHI
20201259486	INHUMAS	IN21326222	INHUMAS S2	11/12/2020 08:03	11/12/2020 15:04	11/12/2020 08:03	11/12/2020 15:04	7,01	1	7,01	CHI
20201259487	LUZIANIA	120280887	RIO VERMELHO	11/12/2020 08:03	11/12/2020 09:23	11/12/2020 08:03	11/12/2020 09:23	1,33	1	1,33	CHI
20201259490	ANAPOLIS	AN11339499	ANAPOLIS UNIVERSITARIO S2	11/12/2020 08:03	11/12/2020 10:27	11/12/2020 08:03	11/12/2020 10:27	2,39	33	78,78	CHI
20201259496	SANTA HELENA DE GOIAS	400026820	IPEGUARI	11/12/2020 08:04	11/12/2020 16:38	11/12/2020 08:04	11/12/2020 16:38	8,56	1	8,56	CHI
20201260017	CAMPO ALEGRE DE GOIAS	CM12042424	CAMPO ALEGRE DE GOIAS	11/12/2020 08:04	11/12/2020 12:29	11/12/2020 08:04	11/12/2020 12:29	4,40	25	110,08	CHI
20201260412	ITABERAI	IB12000062	ITABERAI S2	11/12/2020 08:06	11/12/2020 10:50	11/12/2020 08:06	11/12/2020 10:50	2,72	18	49,01	CHI
20201260412	AMERICANO DO BRASIL	IB12000062	ITABERAI S2	11/12/2020 08:06	11/12/2020 10:50	11/12/2020 08:06	11/12/2020 10:50	2,72	11	29,95	CHI
20201259511	CALDAS NOVAS	CN21186151	SERRA DE CALDAS	11/12/2020 08:07	11/12/2020 10:51	11/12/2020 08:07	11/12/2020 10:51	2,73	1	2,73	CHI
20201259544	NIQUELANDIA	NQ12222646	URUACU	11/12/2020 08:07	11/12/2020 17:45	11/12/2020 08:07	11/12/2020 17:45	9,63	8	77,04	CHI
20201261104	SANTA CRUZ DE GOIAS	BC12072311	CRISTIANOPOLIS	11/12/2020 08:07	11/12/2020 17:36	11/12/2020 08:07	11/12/2020 17:36	9,48	3	28,44	CHI
20201261818	MINEIROS	MY12202613RE	PARQUE DAS EMAS	11/12/2020 08:08	12/12/2020 01:37	11/12/2020 08:08	12/12/2020 01:37	17,47	10	174,71	CHI
20201259533	GOIANIA	10654161	CAMPINAS S1	11/12/2020 08:09	11/12/2020 08:54	11/12/2020 08:09	11/12/2020 08:54	0,74	1	0,74	CHI
20201259531	NAZARIO	440022150	ANICUNS	11/12/2020 08:10	11/12/2020 09:49	11/12/2020 08:10	11/12/2020 09:49	1,65	1	1,65	CHI
20201259535	TEREZOPOLIS DE GOIAS	TJ21212672	JUNDAI S2	11/12/2020 08:10	11/12/2020 14:32	11/12/2020 08:10	11/12/2020 14:32	6,36	1	6,36	CHI
20201259538	SANTO ANTONIO DO DESCOBERTO	10010624242	AGUAS LINDAS DE GOIAS S2	11/12/2020 08:10	11/12/2020 10:02	11/12/2020 08:10	11/12/2020 10:02	1,85	1	1,85	CHI
20201261572	JARAGUA	JA12099140	JARAGUA	11/12/2020 08:10	11/12/2020 16:00	11/12/2020 08:10	11/12/2020 16:00	7,82	9	70,39	CHI
20201259648	JUSSARA	JR12059818	IPORA	11/12/2020 08:11	11/12/2020 14:06	11/12/2020 08:11	11/12/2020 14:06	5,91	6	35,48	CHI
20201259554	JATAI	JT21134907	JATAI S1	11/12/2020 08:12	11/12/2020 15:10	11/12/2020 08:12	11/12/2020 15:10	6,97	1	6,97	CHI
20201259556	RIO VERDE	RV21131629	CABRIUVA S1	11/12/2020 08:12	11/12/2020 10:07	11/12/2020 08:12	11/12/2020 10:07	1,91	1	1,91	CHI
20201259629	BONOPOLIS	BX12202542	SAO MIGUEL DO ARAGUAIA	11/12/2020 08:13	11/12/2020 17:04	11/12/2020 08:13	11/12/2020 16:19	8,09	22	178,07	CHI
20201259629	BONOPOLIS	BX12292422	SAO MIGUEL DO ARAGUAIA	11/12/2020 08:13	11/12/2020 17:04	11/12/2020 08:13	11/12/2020 17:04	8,84	32	283,01	CHI
20201259629	PORANGATU	BX12292422	SAO MIGUEL DO ARAGUAIA	11/12/2020 08:13	11/12/2020 17:04	11/12/2020 08:13	11/12/2020 17:04	8,84	1	8,84	CHI
20201259569	VALPARAISO DE GOIAS	2860081660	PACAEMBU S1	11/12/2020 08:14	11/12/2020 10:31	11/12/2020 08:14	11/12/2020 10:31	2,28	1	2,28	CHI
20201259578	CABECEIRAS	CW12342410	ITUIQUIRA	11/12/2020 08:15	12/12/2020 12:43	11/12/2020 08:15	12/12/2020 12:43	28,45	1	28,45	CHI
20201259579	GOIANESIA	GE21089940	GOIANESIA S2	11/12/2020 08:15	11/12/2020 22:34	11/12/2020 08:15	11/12/2020 22:34	14,30	2	28,60	CHI
20201259613	PIRES DO RIO	PR12000096RE	PIRES DO RIO S1	11/12/2020 08:15	11/12/2020 10:38	11/12/2020 08:15	11/12/2020 10:38	2,38	22	52,40	CHI
20201259613	PALMELO	PR12000096RE	PIRES DO RIO S1	11/12/2020 08:15	11/12/2020 10:38	11/12/2020 08:15	11/12/2020 10:38	2,38	6	14,29	CHI
20201259581	AGUAS LINDAS DE GOIAS	10019282611	AGUAS LINDAS DE GOIAS S1	11/12/2020 08:16	11/12/2020 10:00	11/12/2020 08:16	11/12/2020 10:00	1,73	1	1,73	CHI
20201259589	GUAPO	10019716565	GUAPO S1	11/12/2020 08:17	11/12/2020 10:12	11/12/2020 08:17	11/12/2020 10:12	1,91	1	1,91	CHI
20201259590	GRIZONA	OZ12390431	PIRES DO RIO S2	11/12/2020 08:17	12/12/2020 11:13	11/12/2020 08:17	12/12/2020 11:13	26,92	114	3068,53	CHI
20201259594	BURITI ALEGRE	BG21000111	ITUMBIARA VELHA S2	11/12/2020 08:18	11/12/2020 18:20	11/12/2020 08:18	11/12/2020 18:20	10,03	1	10,03	CHI
20201259598	PORTEIRO	BJ11305326	RIO DOS BOIS	11/12/2020 08:19	11/12/2020 12:14	11/12/2020 08:19	11/12/2020 12:14	3,92	1	3,92	CHI
20201259600	ANICUNS	910001716	ANICUNS	11/12/2020 08:19	11/12/2020 11:52	11/12/2020 08:19	11/12/2020 11:52	3,54	1	3,54	CHI
20201259601	SANTA CRUZ DE GOIAS	BC21118785	PIRES DO RIO S2	11/12/2020 08:19	12/12/2020 09:05	11/12/2020 08:19	12/12/2020 09:05	24,76	1	24,76	CHI
20201259602	FIRMINOPOLIS	FR21092471	SAO LUIZ DOS MONTES BELOS	11/12/2020 08:19	11/12/2020 11:24	11/12/2020 08:19	11/12/2020 11:24	3,07	1	3,07	CHI
20201259604	CALDAS NOVAS	CN11214012	SERRA DE CALDAS	11/12/2020 08:20	11/12/2020 11:39	11/12/2020 08:20	11/12/2020 11:39	3,31	8	26,52	CHI
20201259605	COCALZINHO DE GOIAS	CB12028344	COCALZINHO	11/12/2020 08:20	11/12/2020 10:45	11/12/2020 08:20	11/12/2020 10:45	2,41	4	9,66	CHI
20201259608	ANAPOLIS	21040266	ANAPOLIS UNIVERSITARIO S2	11/12/2020 08:20	11/12/2020 11:48	11/12/2020 08:20	11/12/2020 11:48	3,46	1	3,46	CHI
20201259609	VILA PROPICIO	NP21298247	GOIANESIA S1	11/12/2020 08:20	11/12/2020 13:58	11/12/2020 08:20	11/12/2020 13:58	5,62	1	5,62	CHI
20201259617	JATAI	290107234	JATAI S2	11/12/2020 08:21	11/12/2020 18:03	11/12/2020 08:21	11/12/2020 18:03	9,68	1	9,68	CHI
20201259624	IPAMERI	CT21240858	CATALAO S1	11/12/2020 08:22	11/12/2020 12:40	11/12/2020 08:22	11/12/2020 12:40	4,28	1	4,28	CHI

20201259625	ALVORADA DO NORTE	SI21241943	IACIARA S2	11/12/2020 08:22	11/12/2020 11:24	11/12/2020 08:22	11/12/2020 11:24	3,02	1	3,02	CHI
20201259630	PIRACANJUBA	PJ21316630	BELA VISTA S1	11/12/2020 08:23	11/12/2020 10:23	11/12/2020 08:23	11/12/2020 10:23	1,99	1	1,99	CHI
20201259631	PARAUNA	980024950	PARAUNA	11/12/2020 08:23	11/12/2020 13:06	11/12/2020 08:23	11/12/2020 13:06	4,72	1	4,72	CHI
20201260295	BOM JESUS DE GOIAS	BJ12068991	BOM JESUS DE GOIAS	11/12/2020 08:23	11/12/2020 19:33	11/12/2020 08:23	11/12/2020 19:33	11,16	10	111,56	CHI
20201259636	APARECIDA DE GOIANIA	10009282490	REAL S1	11/12/2020 08:24	11/12/2020 11:08	11/12/2020 08:24	11/12/2020 11:08	2,73	1	2,73	CHI
20201259643	CATALAO	CT21333324	CATALAO S1	11/12/2020 08:24	11/12/2020 10:17	11/12/2020 08:24	11/12/2020 10:17	1,87	1	1,87	CHI
20201259975	CACU	CC11000019	CACHOEIRA ALTA	11/12/2020 08:24	11/12/2020 13:16	11/12/2020 08:24	11/12/2020 13:16	4,87	163	793,18	CHI
20201259650	PORANGATU	PO12182336	PORANGATU	11/12/2020 08:25	11/12/2020 10:14	11/12/2020 08:25	11/12/2020 10:14	1,81	5	9,05	CHI
20201259659	MINEIROS	MY21226473	PARQUE DAS EMAS	11/12/2020 08:26	12/12/2020 08:33	11/12/2020 08:26	12/12/2020 08:33	24,11	1	24,11	CHI
20201259734	SAO LUIS DE MONTES BELOS	SL12125616	FIRMINOPOLIS S1	11/12/2020 08:26	11/12/2020 11:29	11/12/2020 08:26	11/12/2020 11:29	3,04	10	30,44	CHI
20201260161	JESUPOLIS	SR12130200	INHUMAS S1	11/12/2020 08:26	11/12/2020 20:41	11/12/2020 08:26	11/12/2020 20:41	12,25	15	183,74	CHI
20201259661	PORANGATU	PO21236133	NOVO PLANALTO	11/12/2020 08:27	11/12/2020 09:32	11/12/2020 08:27	11/12/2020 09:32	1,08	1	1,08	CHI
20201259663	JATAI	JT21336972	JATAI S2	11/12/2020 08:27	11/12/2020 12:31	11/12/2020 08:27	11/12/2020 12:31	4,06	1	4,06	CHI
20201259665	PORTEIRAO	CL12030933LD	RIO DOS BOIS	11/12/2020 08:27	11/12/2020 16:20	11/12/2020 08:27	11/12/2020 16:20	7,88	4	31,50	CHI
20201259675	MORRINHOS	MR12000005	MORRINHOS	11/12/2020 08:28	11/12/2020 10:35	11/12/2020 08:28	11/12/2020 10:35	2,11	479	1008,83	CHI
20201261198	CALDAZINHA	SV12202383	CEPAIGO S2	11/12/2020 08:28	11/12/2020 15:07	11/12/2020 08:28	11/12/2020 15:07	6,63	14	92,87	CHI
20201261198	SILVANIA	SV12202383	CEPAIGO S2	11/12/2020 08:28	11/12/2020 15:07	11/12/2020 08:28	11/12/2020 15:07	6,63	4	26,54	CHI
20201259679	CRISTALINA	KR12417561	CRISTALINA S2	11/12/2020 08:29	11/12/2020 12:45	11/12/2020 08:29	11/12/2020 12:45	4,26	5	21,30	CHI
20201259681	URUACU	640043355	URUACU	11/12/2020 08:29	11/12/2020 09:54	11/12/2020 08:29	11/12/2020 09:54	1,40	1	1,40	CHI
20201259688	JUSSARA	JR21331698	JUSSARA	11/12/2020 08:30	11/12/2020 15:30	11/12/2020 08:30	11/12/2020 15:30	7,00	1	7,00	CHI
20201259694	AMARALINA	LC12230319	NOVA CRIXAS	11/12/2020 08:31	12/12/2020 03:08	11/12/2020 08:31	12/12/2020 03:08	18,60	3	55,81	CHI
20201259695	GOIAS	GS11162299	GOIAS	11/12/2020 08:31	11/12/2020 14:19	11/12/2020 08:31	11/12/2020 14:19	5,79	2	11,57	CHI
20201261936	CABECEIRAS	CW21344408	ITUIQUIRA	11/12/2020 08:31	11/12/2020 21:14	11/12/2020 08:31	11/12/2020 21:14	12,72	1	12,72	CHI
20201259458	SENADOR CANEDO	SW11322988	SENADOR CANEDO	11/12/2020 08:32	11/12/2020 11:52	11/12/2020 08:32	11/12/2020 11:52	3,33	97	323,20	CHI
20201259698	SERRANOPOLIS	SX12137304	ITAJA S1	11/12/2020 08:32	11/12/2020 23:01	11/12/2020 08:32	11/12/2020 23:01	14,48	9	130,28	CHI
20201259701	ABADIANIA	AA12384863	DAIA S2	11/12/2020 08:32	11/12/2020 14:54	11/12/2020 08:32	11/12/2020 14:54	6,35	34	216,00	CHI
20201260524	HEITORAI	HE12158782	ITAPURANGA	11/12/2020 08:32	11/12/2020 14:45	11/12/2020 08:32	11/12/2020 14:45	6,21	4	24,83	CHI
20201260524	ITAPURANGA	HE12158782	ITAPURANGA	11/12/2020 08:32	11/12/2020 14:45	11/12/2020 08:32	11/12/2020 14:45	6,21	16	99,32	CHI
20201259703	CATURAI	CK21167906	ARACU	11/12/2020 08:33	11/12/2020 21:15	11/12/2020 08:33	11/12/2020 21:15	12,70	1	12,70	CHI
20201259708	URUACU	UR12339121	MARA ROSA	11/12/2020 08:33	11/12/2020 12:14	11/12/2020 08:33	11/12/2020 12:14	3,68	7	25,75	CHI
20201259712	ITUMBIARA	IT21000149	PARANAIBA	11/12/2020 08:33	11/12/2020 11:00	11/12/2020 08:33	11/12/2020 11:00	2,44	1	2,44	CHI
20201259885	DIVINOPOLIS DE GOIAS	GH12389051	SAO DOMINGOS	11/12/2020 08:33	11/12/2020 12:19	11/12/2020 08:33	11/12/2020 12:19	3,76	24	90,16	CHI
20201259715	PETROLINA DE GOIAS	320025214	PETROLINA	11/12/2020 08:34	11/12/2020 14:15	11/12/2020 08:34	11/12/2020 14:15	5,68	1	5,68	CHI
20201259725	IPAMERI	580049723	IPAMERI	11/12/2020 08:35	11/12/2020 11:52	11/12/2020 08:35	11/12/2020 11:52	3,27	1	3,27	CHI
20201259729	PARANAIGUARA	PC21119195	QUIRINOPOLIS	11/12/2020 08:35	11/12/2020 12:43	11/12/2020 08:35	11/12/2020 12:43	4,12	2	8,23	CHI
20201259968	NOVA ROMA	MA12236748	SAO DOMINGOS	11/12/2020 08:35	11/12/2020 13:28	11/12/2020 08:35	11/12/2020 13:28	4,88	57	278,35	CHI
20201259968	MONTE ALEGRE DE GOIAS	MA12236748	SAO DOMINGOS	11/12/2020 08:35	11/12/2020 13:28	11/12/2020 08:35	11/12/2020 13:28	4,88	2	9,77	CHI
20201260275	PALMEIRAS DE GOIAS	PL12000110	PALMEIRAS	11/12/2020 08:35	11/12/2020 12:06	11/12/2020 08:35	11/12/2020 12:06	3,51	22	77,27	CHI
20201259730	POSSE	6257680	IACIARA S2	11/12/2020 08:36	11/12/2020 18:36	11/12/2020 08:36	11/12/2020 18:36	10,00	1	10,00	CHI
20201259731	CAMPO ALEGRE DE GOIAS	CM12086086	CAMPO ALEGRE DE GOIAS	11/12/2020 08:36	11/12/2020 11:50	11/12/2020 08:36	11/12/2020 11:50	3,23	6	19,38	CHI
20201259811	GOIANIA	GN11000575	AEROPORTO S2	11/12/2020 08:36	11/12/2020 09:53	11/12/2020 08:36	11/12/2020 09:53	1,28	61	78,01	CHI
20201259746	IACIARA	ND12218839	IACIARA S2	11/12/2020 08:38	11/12/2020 12:38	11/12/2020 08:38	11/12/2020 12:38	4,00	24	95,91	CHI
20201259746	SAO DOMINGOS	ND12218839	IACIARA S2	11/12/2020 08:38	11/12/2020 12:38	11/12/2020 08:38	11/12/2020 12:38	4,00	3	11,99	CHI
20201259753	GOIAS	GS21241337	MATRINCHA	11/12/2020 08:39	11/12/2020 14:02	11/12/2020 08:39	11/12/2020 14:02	5,37	1	5,37	CHI
20201259754	GOIANDIRA	GD12000015	CATALAO S1	11/12/2020 08:39	11/12/2020 10:32	11/12/2020 08:39	11/12/2020 10:32	1,87	6	11,23	CHI
20201259762	APARECIDA DE GOIANIA	200185871	ANHANGUERA	11/12/2020 08:40	11/12/2020 10:11	11/12/2020 08:40	11/12/2020 10:11	1,51	1	1,51	CHI
20201259809	SAO DOMINGOS	SD12245178	SAO DOMINGOS	11/12/2020 08:40	11/12/2020 14:20	11/12/2020 08:40	11/12/2020 14:20	5,65	7	39,57	CHI
20201259769	FORMOSA	FA11233790	SAO JOAO D ALIANCA	11/12/2020 08:41	11/12/2020 14:22	11/12/2020 08:41	11/12/2020 14:22	5,68	1	5,68	CHI
20201259772	CATALAO	1990018674	CATALAO S2	11/12/2020 08:42	11/12/2020 10:53	11/12/2020 08:42	11/12/2020 10:53	2,18	1	2,18	CHI
20201259773	JATAI	290165489	JATAI S2	11/12/2020 08:42	11/12/2020 18:23	11/12/2020 08:42	11/12/2020 18:23	9,68	1	9,68	CHI
20201259777	SANTA HELENA DE GOIAS	SH21024957	IPEGUARI	11/12/2020 08:42	11/12/2020 11:15	11/12/2020 08:42	11/12/2020 11:15	2,54	1	2,54	CHI

20201259808	INHUMAS	IN12012260	INHUMAS S2	11/12/2020 08:42	11/12/2020 10:03	11/12/2020 08:42	11/12/2020 10:03	1,34	71	95,46	CHI
20201259784	SAO MIGUEL DO ARAGUAIA	SM21151037	SAO MIGUEL DO ARAGUAIA	11/12/2020 08:44	12/12/2020 12:26	11/12/2020 08:44	12/12/2020 12:26	27,70	1	27,70	CHI
20201259787	JANDAIA	JD12233466	PALMEIRAS	11/12/2020 08:44	11/12/2020 10:37	11/12/2020 08:44	11/12/2020 10:37	1,88	2	3,75	CHI
20201259794	MORRINHOS	MR12074567	MORRINHOS	11/12/2020 08:45	11/12/2020 12:59	11/12/2020 08:45	11/12/2020 12:59	4,22	3	12,65	CHI
20201259798	BURITI ALEGRE	BG12288715	ITUMBIARA VELHA S2	11/12/2020 08:46	12/12/2020 16:39	11/12/2020 08:46	12/12/2020 16:39	31,87	1	31,87	CHI
20201260026	ORIZONA	OZ12000353LD	PIRES DO RIO S1	11/12/2020 08:47	11/12/2020 11:50	11/12/2020 08:47	11/12/2020 11:43	2,94	36	105,73	CHI
20201260026	ORIZONA	OZ12404726	PIRES DO RIO S1	11/12/2020 08:47	11/12/2020 11:50	11/12/2020 11:36	11/12/2020 11:50	0,23	9	2,09	CHI
20201259819	JATAI	290234463	JATAI S2	11/12/2020 08:50	11/12/2020 18:10	11/12/2020 08:50	11/12/2020 18:10	9,33	1	9,33	CHI
20201259820	CALDAS NOVAS	10017917148	CALDAS NOVAS S1	11/12/2020 08:50	11/12/2020 12:23	11/12/2020 08:50	11/12/2020 12:23	3,54	1	3,54	CHI
20201259826	BALIZA	BH21210021	BOM JARDIM	11/12/2020 08:51	11/12/2020 12:22	11/12/2020 08:51	11/12/2020 12:22	3,50	1	3,50	CHI
20201259833	PIRACANJUBA	PJ12074757	CRISTIANOPOLIS	11/12/2020 08:52	11/12/2020 14:18	11/12/2020 08:52	11/12/2020 14:18	5,42	1	5,42	CHI
20201260226	DOVERLANDIA	DV12212846	CAIAPONIA	11/12/2020 08:52	11/12/2020 18:27	11/12/2020 08:52	11/12/2020 18:27	9,58	22	210,77	CHI
20201259834	APARECIDA DE GOIANIA	200204063	ANHANGUERA	11/12/2020 08:53	11/12/2020 10:16	11/12/2020 08:53	11/12/2020 10:16	1,38	1	1,38	CHI
20201259845	MINACU	IH21181636	MINACU	11/12/2020 08:54	11/12/2020 10:37	11/12/2020 08:54	11/12/2020 10:37	1,72	1	1,72	CHI
20201259847	CRISTALINA	KR21180404	CRISTALINA S2	11/12/2020 08:54	11/12/2020 15:33	11/12/2020 08:54	11/12/2020 15:33	6,64	1	6,64	CHI
20201259852	JATAI	JT12326599	JATAI S2	11/12/2020 08:54	11/12/2020 10:57	11/12/2020 08:54	11/12/2020 10:57	2,04	1	2,04	CHI
20201259860	MONTES CLAROS DE GOIAS	ME12212902	IPORA	11/12/2020 08:55	11/12/2020 11:07	11/12/2020 08:55	11/12/2020 11:07	2,19	9	19,75	CHI
20201261021	CACU	CC12075919	CACHOEIRA ALTA	11/12/2020 08:55	12/12/2020 09:46	11/12/2020 08:55	12/12/2020 08:27	23,52	1	23,52	CHI
20201261021	ITARUMA	CC12075919	CACHOEIRA ALTA	11/12/2020 08:55	12/12/2020 09:46	11/12/2020 08:55	12/12/2020 09:05	24,17	4	96,69	CHI
20201261021	ITARUMA	IM12097096	CACHOEIRA ALTA	11/12/2020 08:55	12/12/2020 09:46	12/12/2020 09:20	12/12/2020 09:46	0,44	2	0,87	CHI
20201259873	ABADIANIA	350003026	ANAPOLIS UNIVERSITARIO S1	11/12/2020 08:56	11/12/2020 22:38	11/12/2020 08:56	11/12/2020 22:38	13,69	1	13,69	CHI
20201259876	SENADOR CANEDO	190063993	SENADOR CANEDO	11/12/2020 08:57	11/12/2020 11:21	11/12/2020 08:57	11/12/2020 11:21	2,41	1	2,41	CHI
20201259897	PARAUNA	PU12083052	ACREUNA	11/12/2020 08:57	11/12/2020 12:57	11/12/2020 08:57	11/12/2020 12:57	3,99	16	63,77	CHI
20201259880	GOIANIA	GN12201063	SENADOR CANEDO	11/12/2020 08:58	11/12/2020 10:46	11/12/2020 08:58	11/12/2020 10:46	1,80	153	275,27	CHI
20201259881	PIRES DO RIO	PR21272840	PIRES DO RIO S1	11/12/2020 08:58	11/12/2020 10:57	11/12/2020 08:58	11/12/2020 10:57	1,98	2	3,96	CHI
20201259887	CRISTALINA	KR21261086	CRISTALINA S2	11/12/2020 08:58	11/12/2020 10:19	11/12/2020 08:58	11/12/2020 10:19	1,33	1	1,33	CHI
20201259890	RIO VERDE	10002428910	RIO VERDE S1	11/12/2020 08:59	11/12/2020 12:06	11/12/2020 08:59	11/12/2020 12:06	3,11	1	3,11	CHI
20201259938	GOIANIA	00580254	GOIANIA LESTE S1	11/12/2020 08:59	11/12/2020 12:25	11/12/2020 12:21	11/12/2020 12:24	0,05	2753	146,06	CHI
20201259938	GOIANIA	GN10400560	GOIANIA LESTE S1	11/12/2020 08:59	11/12/2020 12:25	11/12/2020 12:20	11/12/2020 12:25	0,08	797	61,55	CHI
20201259938	GOIANIA	GN16409519	GOIANIA LESTE S2	11/12/2020 08:59	11/12/2020 12:25	11/12/2020 12:19	11/12/2020 12:25	0,11	1	0,11	CHI
20201259896	ITARUMA	IM12041673	CACHOEIRA ALTA	11/12/2020 09:00	11/12/2020 14:16	11/12/2020 09:00	11/12/2020 14:16	5,27	3	15,80	CHI
20201259899	GOIANIA	15516908	GOYA S2	11/12/2020 09:00	11/12/2020 10:47	11/12/2020 09:00	11/12/2020 10:47	1,77	1	1,77	CHI
20201259904	ITUMBIARA	IT12088562RE	ITUMBIARA NOVA	11/12/2020 09:01	11/12/2020 10:03	11/12/2020 09:01	11/12/2020 10:03	1,02	32	32,68	CHI
20201261110	JATAI	JT12260285	JATAI S3	11/12/2020 09:01	11/12/2020 19:04	11/12/2020 09:01	11/12/2020 19:04	10,05	3	30,14	CHI
20201259910	GOIANIA	16131381	MEIA PONTE	11/12/2020 09:02	11/12/2020 14:24	11/12/2020 09:02	11/12/2020 14:24	5,36	1	5,36	CHI
20201260220	RIO VERDE	RV12260653	CABRIUVA S2	11/12/2020 09:02	11/12/2020 11:25	11/12/2020 09:02	11/12/2020 11:25	2,37	9	21,35	CHI
20201259921	PONTALINA	10005613360	PONTALINA	11/12/2020 09:03	11/12/2020 11:49	11/12/2020 09:03	11/12/2020 11:49	2,76	1	2,76	CHI
20201259926	BONOPOLIS	BX12191690	SAO MIGUEL DO ARAGUAIA	11/12/2020 09:04	11/12/2020 11:15	11/12/2020 09:04	11/12/2020 11:15	2,18	3	6,54	CHI
20201259931	RIO VERDE	MV10400640	MONTIVIDIU T	11/12/2020 09:04	11/12/2020 14:57	11/12/2020 09:04	11/12/2020 12:36	3,55	46	163,10	CHI
20201259931	MONTIVIDIU	MV10400640	MONTIVIDIU T	11/12/2020 09:04	11/12/2020 14:57	11/12/2020 09:04	11/12/2020 12:36	3,55	41	145,37	CHI
20201259931	CAIAPONIA	MV10400640	MONTIVIDIU T	11/12/2020 09:04	11/12/2020 14:57	11/12/2020 09:04	11/12/2020 12:36	3,55	6	21,27	CHI
20201259931	MONTIVIDIU	MV12054328	MONTIVIDIU T	11/12/2020 09:04	11/12/2020 14:57	11/12/2020 09:04	11/12/2020 13:42	4,64	14	65,03	CHI
20201259931	CAIAPONIA	CP12260986LD	MONTIVIDIU T	11/12/2020 09:04	11/12/2020 14:57	11/12/2020 09:04	11/12/2020 14:57	5,89	91	535,56	CHI
20201259932	MONTES CLAROS DE GOIAS	ME12204869	BRITANIA	11/12/2020 09:05	12/12/2020 10:38	11/12/2020 09:05	12/12/2020 10:38	25,54	2	51,08	CHI
20201259934	SILVANIA	SV12164042	DAIA S2	11/12/2020 09:05	11/12/2020 14:32	11/12/2020 09:05	11/12/2020 14:32	5,43	2	10,87	CHI
20201259935	ISRAELANDIA	IS21188969	IPORA	11/12/2020 09:06	11/12/2020 14:26	11/12/2020 09:06	11/12/2020 14:26	5,33	1	5,33	CHI
20201259936	ITUMBIARA	IT12330365	CACHOEIRA DOURADA	11/12/2020 09:06	11/12/2020 11:59	11/12/2020 09:06	11/12/2020 11:59	2,88	1	2,88	CHI
20201259941	JATAI	JT21152395	JATAI S1	11/12/2020 09:06	12/12/2020 08:00	11/12/2020 09:06	12/12/2020 08:00	22,89	1	22,89	CHI
20201259942	SIMOLANDIA	SA12099890	IACIARA S2	11/12/2020 09:07	11/12/2020 13:51	11/12/2020 09:07	11/12/2020 13:51	4,73	161	761,98	CHI
20201259944	PONTALINA	PK21307744	PONTALINA	11/12/2020 09:07	11/12/2020 20:51	11/12/2020 09:07	11/12/2020 20:51	11,73	1	11,73	CHI
20201259945	CRISTALINA	KR12332622	CRISTALINA S2	11/12/2020 09:07	11/12/2020 12:58	11/12/2020 09:07	11/12/2020 12:58	3,85	1	3,85	CHI

20201259951	PARAUNA	PU12167339	PARAUNA	11/12/2020 09:07	11/12/2020 15:46	11/12/2020 09:07	11/12/2020 15:46	6,64	4	26,55	CHI
20201259953	SAO MIGUEL DO ARAGUAIA	SM12113573	SAO MIGUEL DO ARAGUAIA	11/12/2020 09:07	11/12/2020 11:53	11/12/2020 09:07	11/12/2020 11:53	2,75	3	8,25	CHI
20201259955	RIO VERDE	10031430897	CABRIUVA S1	11/12/2020 09:08	11/12/2020 13:00	11/12/2020 09:08	11/12/2020 13:00	3,87	1	3,87	CHI
20201259973	ACREUNA	2440082503	ACREUNA	11/12/2020 09:10	11/12/2020 18:23	11/12/2020 09:10	11/12/2020 18:23	9,21	1	9,21	CHI
20201259978	PIRACANJUBA	PJ21223588	CALDAS NOVAS S1	11/12/2020 09:10	12/12/2020 09:31	11/12/2020 09:10	12/12/2020 09:31	24,33	2	48,67	CHI
20201261141	ABADIANIA	AA12261204	ANAPOLIS UNIVERSITARIO S1	11/12/2020 09:10	11/12/2020 17:42	11/12/2020 09:10	11/12/2020 17:42	8,53	24	204,75	CHI
20201259990	GOIANDIRA	GD12064004	CATALAO S1	11/12/2020 09:13	11/12/2020 11:58	11/12/2020 09:13	11/12/2020 11:58	2,75	2	5,50	CHI
20201259990	CATALAO	GD12064004	CATALAO S1	11/12/2020 09:13	11/12/2020 11:58	11/12/2020 09:13	11/12/2020 11:58	2,75	3	8,25	CHI
20201259993	ABADIANIA	350038922	ANAPOLIS UNIVERSITARIO S1	11/12/2020 09:13	11/12/2020 21:31	11/12/2020 09:13	11/12/2020 21:31	12,30	1	12,30	CHI
20201259995	CRIXAS	10027001456	RUBIATABA	11/12/2020 09:13	11/12/2020 14:40	11/12/2020 09:13	11/12/2020 14:40	5,44	1	5,44	CHI
20201260020	SILVANIA	VN21060818	VIANOPOLIS	11/12/2020 09:15	11/12/2020 11:37	11/12/2020 09:15	11/12/2020 11:37	2,35	2	4,70	CHI
20201260669	DOVERLANDIA	DV12139906	CAIAPONIA	11/12/2020 09:15	11/12/2020 16:18	11/12/2020 09:15	11/12/2020 16:18	7,04	10	70,41	CHI
20201260024	NIQUELANDIA	NQ12237324	URUACU	11/12/2020 09:16	11/12/2020 10:43	11/12/2020 09:16	11/12/2020 10:43	1,44	46	66,33	CHI
20201260679	CATALAO	CT12130972	CATALAO S2	11/12/2020 09:16	12/12/2020 10:04	11/12/2020 09:16	11/12/2020 13:51	4,58	16	73,32	CHI
20201260679	CATALAO	CT12130972	CATALAO S2	11/12/2020 09:16	12/12/2020 10:04	11/12/2020 09:16	12/12/2020 10:04	24,81	10	248,06	CHI
20201260679	CUMARI	CT12130972	CATALAO S2	11/12/2020 09:16	12/12/2020 10:04	11/12/2020 09:16	12/12/2020 10:04	24,81	1	24,81	CHI
20201260679	CATALAO	CT12316068	CATALAO S2	11/12/2020 09:16	12/12/2020 10:04	11/12/2020 12:00	12/12/2020 10:04	22,08	1	22,08	CHI
20201260031	CATALAO	1990238273	CATALAO S2	11/12/2020 09:17	11/12/2020 10:25	11/12/2020 09:17	11/12/2020 10:25	1,13	1	1,13	CHI
20201260033	NOVA ROMA	ND12392238	IACIARA S2	11/12/2020 09:17	11/12/2020 18:00	11/12/2020 09:17	11/12/2020 18:00	8,71	245	2133,75	CHI
20201260038	SAO LUIZ DO NORTE	SZ12348617	ITAPACI	11/12/2020 09:17	11/12/2020 16:28	11/12/2020 09:17	11/12/2020 16:28	7,17	32	229,39	CHI
20201260050	MINEIROS	MY12296320RE	PARQUE DAS EMAS	11/12/2020 09:17	12/12/2020 02:05	11/12/2020 09:17	12/12/2020 02:05	16,79	11	184,69	CHI
20201261036	PARAUNA	PU12228071	PARAUNA	11/12/2020 09:17	11/12/2020 14:58	11/12/2020 09:17	11/12/2020 14:58	5,67	5	28,37	CHI
20201260039	DOVERLANDIA	DV11138412	CAIAPONIA	11/12/2020 09:18	11/12/2020 13:45	11/12/2020 09:18	11/12/2020 13:45	4,45	3	13,35	CHI
20201260041	APARECIDA DE GOIANIA	200253955	INDEPENDENCIA S2	11/12/2020 09:18	11/12/2020 11:02	11/12/2020 09:18	11/12/2020 11:02	1,73	1	1,73	CHI
20201260043	JATAI	JT21000177	JATAI S2	11/12/2020 09:18	12/12/2020 04:30	11/12/2020 09:18	12/12/2020 04:30	19,20	1	19,20	CHI
20201260045	EDEALINA	ED12223301	PONTALINA	11/12/2020 09:18	11/12/2020 14:36	11/12/2020 09:18	11/12/2020 14:36	5,30	4	21,18	CHI
20201260064	NOVO BRASIL	NB12020215	JUSSARA	11/12/2020 09:21	11/12/2020 14:41	11/12/2020 09:21	11/12/2020 14:41	5,33	23	122,61	CHI
20201260071	MAURILANDIA	ML21303718	SANTA HELENA S1	11/12/2020 09:21	11/12/2020 22:49	11/12/2020 09:21	11/12/2020 22:49	13,46	1	13,46	CHI
20201260077	CRISTALINA	KR21351499	CRISTALINA S1	11/12/2020 09:22	11/12/2020 13:43	11/12/2020 09:22	11/12/2020 13:43	4,35	1	4,35	CHI
20201260078	CAIAPONIA	MV21295832	MONTIVIDIU T	11/12/2020 09:22	11/12/2020 10:42	11/12/2020 09:22	11/12/2020 10:42	1,33	1	1,33	CHI
20201260081	CACHOEIRA ALTA	CA21078874	CACHOEIRA ALTA	11/12/2020 09:22	11/12/2020 12:04	11/12/2020 09:22	11/12/2020 12:04	2,70	1	2,70	CHI
20201260082	GOIANIA	14142260	CARAIAS S2	11/12/2020 09:22	11/12/2020 11:48	11/12/2020 09:22	11/12/2020 11:48	2,42	1	2,42	CHI
20201260952	SAO MIGUEL DO ARAGUAIA	SM12252091	SAO MIGUEL DO ARAGUAIA	11/12/2020 09:23	11/12/2020 14:29	11/12/2020 09:23	11/12/2020 14:29	5,09	61	310,78	CHI
20201260094	JUSSARA	JR12009961	JUSSARA	11/12/2020 09:24	11/12/2020 15:15	11/12/2020 09:24	11/12/2020 15:15	5,84	3	17,53	CHI
20201260101	TRINDADE	TR12222070	TRINDADE	11/12/2020 09:24	11/12/2020 15:09	11/12/2020 09:24	11/12/2020 15:09	5,74	1	5,74	CHI
20201260111	DIORAMA	DI21231106	ARENOPOLIS	11/12/2020 09:25	11/12/2020 11:40	11/12/2020 09:25	11/12/2020 11:40	2,24	1	2,24	CHI
20201260112	JATAI	290048138	JATAI S3	11/12/2020 09:25	11/12/2020 20:53	11/12/2020 09:25	11/12/2020 20:53	11,45	1	11,45	CHI
20201260118	CACU	1140001696	CACHOEIRA ALTA	11/12/2020 09:26	11/12/2020 16:21	11/12/2020 09:26	11/12/2020 16:21	6,91	1	6,91	CHI
20201260120	PADRE BERNARDO	PB12376756	PADRE BERNARDO	11/12/2020 09:26	11/12/2020 13:47	11/12/2020 09:26	11/12/2020 13:47	4,34	5	21,71	CHI
20201260122	GAMELEIRA DE GOIAS	SV21287750	DAIA S2	11/12/2020 09:26	11/12/2020 11:26	11/12/2020 09:26	11/12/2020 11:26	1,98	1	1,98	CHI
20201260133	ITUMBIARA	CD21000313	BOM JESUS DE GOIAS	11/12/2020 09:28	11/12/2020 20:45	11/12/2020 09:28	11/12/2020 20:45	11,28	1	11,28	CHI
20201260135	JATAI	290173097	JATAI S2	11/12/2020 09:28	11/12/2020 13:35	11/12/2020 09:28	11/12/2020 13:35	4,11	1	4,11	CHI
20201260252	PARAUNA	00190214	PALMEIRAS	11/12/2020 09:29	12/12/2020 11:00	11/12/2020 17:46	11/12/2020 17:52	0,10	46	4,60	CHI
20201260252	JANDAIA	00190214	PALMEIRAS	11/12/2020 09:29	12/12/2020 11:00	11/12/2020 17:46	11/12/2020 17:52	0,10	1908	190,80	CHI
20201260252	JANDAIA	JD13000008	PALMEIRAS	11/12/2020 09:29	12/12/2020 11:00	11/12/2020 09:29	11/12/2020 20:53	11,39	16	182,18	CHI
20201260252	INDIARA	JD13000008	PALMEIRAS	11/12/2020 09:29	12/12/2020 11:00	11/12/2020 09:29	11/12/2020 20:53	11,39	49	557,93	CHI
20201260252	JANDAIA	JD13000008	PALMEIRAS	11/12/2020 09:29	12/12/2020 11:00	11/12/2020 09:29	12/12/2020 00:56	15,44	21	324,19	CHI
20201260252	JANDAIA	JD13000008	PALMEIRAS	11/12/2020 09:29	12/12/2020 11:00	11/12/2020 14:42	12/12/2020 00:56	10,23	1	10,23	CHI
20201260252	JANDAIA	JD10394978	PALMEIRAS	11/12/2020 09:29	12/12/2020 11:00	11/12/2020 17:46	12/12/2020 00:56	7,16	1	7,16	CHI
20201260252	PARAUNA	JD12308479	PALMEIRAS	11/12/2020 09:29	12/12/2020 11:00	11/12/2020 09:29	12/12/2020 01:41	16,19	6	97,13	CHI
20201260252	JANDAIA	JD12308479	PALMEIRAS	11/12/2020 09:29	12/12/2020 11:00	11/12/2020 09:29	12/12/2020 01:41	16,19	148	2395,83	CHI

20201260252	JANDAIA	00190214	PALMEIRAS	11/12/2020 09:29	12/12/2020 11:00	12/12/2020 01:42	12/12/2020 01:53	0,19	2082	393,27	CHI
20201260252	PARAUNA	00190214	PALMEIRAS	11/12/2020 09:29	12/12/2020 11:00	12/12/2020 01:42	12/12/2020 01:53	0,19	52	9,82	CHI
20201260252	PALMEIRAS DE GOIAS	JD12005507LD	PALMEIRAS	11/12/2020 09:29	12/12/2020 11:00	11/12/2020 09:29	12/12/2020 04:12	18,71	38	710,92	CHI
20201260252	JANDAIA	JD12005507LD	PALMEIRAS	11/12/2020 09:29	12/12/2020 11:00	11/12/2020 09:29	12/12/2020 04:12	18,71	31	579,96	CHI
20201260252	INDIARA	JD12005507LD	PALMEIRAS	11/12/2020 09:29	12/12/2020 11:00	11/12/2020 09:29	12/12/2020 04:12	18,71	132	2469,50	CHI
20201260252	JANDAIA	JD12308472	PALMEIRAS	11/12/2020 09:29	12/12/2020 11:00	11/12/2020 09:29	12/12/2020 11:00	25,51	2	51,03	CHI
20201260143	MATRINCHA	4370002255	MATRINCHA	11/12/2020 09:30	11/12/2020 17:01	11/12/2020 09:30	11/12/2020 17:01	7,52	1	7,52	CHI
20201260146	APARECIDA DE GOIANIA	AP21127432	ANHANGUERA	11/12/2020 09:30	11/12/2020 18:10	11/12/2020 09:30	11/12/2020 18:10	8,67	1	8,67	CHI
20201260152	NOVO BRASIL	NB12019355	JUSSARA	11/12/2020 09:30	11/12/2020 13:25	11/12/2020 09:30	11/12/2020 13:25	3,90	5	19,52	CHI
20201260842	MINEIROS	MY12303343RE	PARQUE DAS EMAS	11/12/2020 09:30	11/12/2020 17:13	11/12/2020 09:30	11/12/2020 17:13	7,71	10	77,13	CHI
20201260157	GOIANIA	12602589	ATLANTICO S1	11/12/2020 09:31	11/12/2020 11:38	11/12/2020 09:31	11/12/2020 11:38	2,11	1	2,11	CHI
20201260167	MUTUNOPOLIS	MU12129781	MARA ROSA	11/12/2020 09:32	11/12/2020 11:19	11/12/2020 09:32	11/12/2020 11:19	1,77	7	12,40	CHI
20201260171	RIO VERDE	630571752	CABRIUVA S1	11/12/2020 09:32	11/12/2020 12:17	11/12/2020 09:32	11/12/2020 12:17	2,73	1	2,73	CHI
20201260177	GUAPO	GA21141586	INDEPENDENCIA S2	11/12/2020 09:33	11/12/2020 12:17	11/12/2020 09:33	11/12/2020 12:17	2,72	2	5,44	CHI
20201260366	CAIAPONIA	CP12268503	CAIAPONIA	11/12/2020 09:33	11/12/2020 18:42	11/12/2020 09:33	11/12/2020 18:42	9,14	11	100,57	CHI
20201260689	ITAPACI	IW12405289	ITAPACI	11/12/2020 09:33	11/12/2020 12:57	11/12/2020 09:33	11/12/2020 12:57	3,40	14	47,54	CHI
20201258423	JOVIANIA	JV21087243	GOIATUBA S1	11/12/2020 09:34	12/12/2020 15:59	11/12/2020 09:34	12/12/2020 15:17	29,71	1	29,71	CHI
20201258423	JOVIANIA	JV12052761	GOIATUBA S1	11/12/2020 09:34	12/12/2020 15:59	12/12/2020 11:23	12/12/2020 15:59	4,59	5	22,93	CHI
20201260179	CRISTALINA	KR21385520	CRISTALINA S2	11/12/2020 09:34	11/12/2020 14:38	11/12/2020 09:34	11/12/2020 14:38	5,06	1	5,06	CHI
20201261687	NOVA GLORIA	GE12241509	GOIANESIA S1	11/12/2020 09:34	11/12/2020 22:24	11/12/2020 09:34	11/12/2020 22:24	12,83	2	25,65	CHI
20201261687	SANTA ISABEL	GE12241509	GOIANESIA S1	11/12/2020 09:34	11/12/2020 22:24	11/12/2020 09:34	11/12/2020 22:24	12,83	2	25,65	CHI
20201261687	GOIANESIA	GE12241509	GOIANESIA S1	11/12/2020 09:34	11/12/2020 22:24	11/12/2020 09:34	11/12/2020 22:24	12,83	2	25,65	CHI
20201260188	APARECIDA DE GOIANIA	10000772362	INDEPENDENCIA S2	11/12/2020 09:35	11/12/2020 10:28	11/12/2020 09:35	11/12/2020 10:28	0,87	1	0,87	CHI
20201262649	PIRENOPOLIS	PV12377430	GOIANESIA S1	11/12/2020 09:35	11/12/2020 19:20	11/12/2020 09:35	11/12/2020 19:20	9,75	10	97,48	CHI
20201260192	CACHOEIRA DOURADA	10032151444	CACHOEIRA DOURADA	11/12/2020 09:36	11/12/2020 14:04	11/12/2020 09:36	11/12/2020 14:04	4,47	1	4,47	CHI
20201260197	APORE	AE12340774	ITAJA S2	11/12/2020 09:36	11/12/2020 16:49	11/12/2020 09:36	11/12/2020 16:49	7,21	1	7,21	CHI
20201260206	CATALAO	9580011004	CATALAO S1	11/12/2020 09:36	11/12/2020 15:48	11/12/2020 09:36	11/12/2020 15:48	6,18	1	6,18	CHI
20201260307	GOIANIA	GN11001154	GOIANIA LESTE S1	11/12/2020 09:36	11/12/2020 12:08	11/12/2020 09:36	11/12/2020 12:08	2,52	215	542,04	CHI
20201261286	INDIARA	IY12010814	EDEIA	11/12/2020 09:36	11/12/2020 14:04	11/12/2020 09:36	11/12/2020 14:04	4,45	10	44,52	CHI
20201260214	GOIANIA	GN12169506	GOYA S2	11/12/2020 09:37	11/12/2020 15:14	11/12/2020 12:10	11/12/2020 15:14	3,07	8	24,58	CHI
20201260216	VIANOPOLIS	VN21136784	VIANOPOLIS	11/12/2020 09:38	11/12/2020 16:12	11/12/2020 09:38	11/12/2020 16:12	6,57	1	6,57	CHI
20201260218	ANAPOLIS	21246865	JUNDIAI S2	11/12/2020 09:38	11/12/2020 12:28	11/12/2020 09:38	11/12/2020 12:28	2,83	1	2,83	CHI
20201260225	CORUMBAIBA	CI21041818	VILA CORUMBA	11/12/2020 09:39	11/12/2020 12:24	11/12/2020 09:39	11/12/2020 12:24	2,74	1	2,74	CHI
20201260229	QUIRINOPOLIS	CC21378077	CACHOEIRA ALTA	11/12/2020 09:40	11/12/2020 21:00	11/12/2020 09:40	11/12/2020 21:00	11,33	1	11,33	CHI
20201260232	FORMOSA	FA12322753	ITUIQUIRA	11/12/2020 09:40	11/12/2020 10:56	11/12/2020 09:40	11/12/2020 10:56	1,26	2	2,51	CHI
20201260233	BONOPOLIS	BX12334612	SAO MIGUEL DO ARAGUAIA	11/12/2020 09:40	12/12/2020 00:05	11/12/2020 09:40	12/12/2020 00:05	14,41	2	28,81	CHI
20201260301	CACHOEIRA ALTA	CA10395315	CACHOEIRA ALTA	11/12/2020 09:40	11/12/2020 10:15	11/12/2020 09:40	11/12/2020 10:15	0,57	3	1,72	CHI
20201260301	RIO VERDE	CA10395315	CACHOEIRA ALTA	11/12/2020 09:40	11/12/2020 10:15	11/12/2020 09:40	11/12/2020 10:15	0,57	10	5,75	CHI
20201260301	APARECIDA DO RIO DOCE	CA10395315	CACHOEIRA ALTA	11/12/2020 09:40	11/12/2020 10:15	11/12/2020 09:40	11/12/2020 10:15	0,57	641	368,40	CHI
20201260301	JATAI	CA10395315	CACHOEIRA ALTA	11/12/2020 09:40	11/12/2020 10:15	11/12/2020 09:40	11/12/2020 10:15	0,57	1	0,57	CHI
20201260301	JATAI	CA10395315	CACHOEIRA ALTA	11/12/2020 09:40	11/12/2020 10:15	11/12/2020 09:40	11/12/2020 10:15	0,57	36	20,69	CHI
20201260301	CACHOEIRA ALTA	CA10395315	CACHOEIRA ALTA	11/12/2020 09:40	11/12/2020 10:15	11/12/2020 09:40	11/12/2020 10:15	0,57	67	38,51	CHI
20201260301	APARECIDA DO RIO DOCE	CA10395315	CACHOEIRA ALTA	11/12/2020 09:40	11/12/2020 10:15	11/12/2020 09:40	11/12/2020 10:15	0,57	604	347,13	CHI
20201260301	RIO VERDE	CA10395315	CACHOEIRA ALTA	11/12/2020 09:40	11/12/2020 10:15	11/12/2020 09:40	11/12/2020 10:15	0,57	169	97,13	CHI
20201260301	RIO VERDE	CA10395315	CACHOEIRA ALTA	11/12/2020 09:40	11/12/2020 10:15	11/12/2020 09:40	11/12/2020 10:15	0,57	7	4,02	CHI
20201260301	CACHOEIRA ALTA	CA10395315	CACHOEIRA ALTA	11/12/2020 09:40	11/12/2020 10:15	11/12/2020 09:40	11/12/2020 10:15	0,57	58	33,33	CHI
20201260389	MINACU	IH16404039	MINACU	11/12/2020 09:41	11/12/2020 10:16	11/12/2020 09:53	11/12/2020 10:16	0,39	178	69,02	CHI
20201260241	EDEIA	EA12086996	EDEIA	11/12/2020 09:42	11/12/2020 16:16	11/12/2020 09:42	11/12/2020 16:16	6,58	2	13,16	CHI
20201260248	INHUMAS	IN21247255	INHUMAS S2	11/12/2020 09:42	11/12/2020 22:17	11/12/2020 09:42	11/12/2020 22:17	12,57	1	12,57	CHI
20201260251	JUSSARA	RN21405870	BRITANIA	11/12/2020 09:43	11/12/2020 11:22	11/12/2020 09:43	11/12/2020 11:22	1,64	1	1,64	CHI
20201260256	FLORES DE GOIAS	FB21044975	IACIARA S2	11/12/2020 09:43	11/12/2020 12:04	11/12/2020 09:43	11/12/2020 12:04	2,34	1	2,34	CHI

20201260493	ALEXANIA	AX12190681	ALEXANIA	11/12/2020 09:43	11/12/2020 13:00	11/12/2020 09:43	11/12/2020 13:00	3,27	21	68,66	CHI
20201260489	MONTES CLAROS DE GOIAS	ME11040179	IPORA	11/12/2020 09:44	11/12/2020 20:33	11/12/2020 09:44	11/12/2020 20:33	10,81	125	1351,74	CHI
20201260271	APARECIDA DE GOIANIA	200626048	INDEPENDENCIA S1	11/12/2020 09:45	11/12/2020 11:07	11/12/2020 09:45	11/12/2020 11:07	1,36	1	1,36	CHI
20201260441	MUTUNOPOLIS	MU12336210	MARA ROSA	11/12/2020 09:45	11/12/2020 12:03	11/12/2020 09:45	11/12/2020 12:03	2,30	4	9,19	CHI
20201260582	JUSSARA	JR12019908	JUSSARA	11/12/2020 09:46	11/12/2020 12:02	11/12/2020 09:46	11/12/2020 12:02	2,26	4	9,02	CHI
20201260279	TURVELANDIA	TD21384563	RIO DOS BOIS	11/12/2020 09:47	11/12/2020 13:41	11/12/2020 09:47	11/12/2020 13:41	3,90	1	3,90	CHI
2020121100036	ANAPOLIS	00050404	ANAPOLIS UNIVERSITARIO S1	11/12/2020 09:47	11/12/2020 09:51	11/12/2020 09:47	11/12/2020 09:51	0,07	1	0,07	CHI
2020121100036	ABADIANIA	00232	ANAPOLIS UNIVERSITARIO S1	11/12/2020 09:47	11/12/2020 09:51	11/12/2020 09:47	11/12/2020 09:51	0,07	30	2,00	CHI
2020121100036	ANAPOLIS	00201	ANAPOLIS UNIVERSITARIO S1	11/12/2020 09:47	11/12/2020 09:51	11/12/2020 09:47	11/12/2020 09:51	0,07	101	6,73	CHI
20201260289	CATALAO	CT21195432	CATALAO S1	11/12/2020 09:48	11/12/2020 13:32	11/12/2020 09:48	11/12/2020 13:32	3,73	1	3,73	CHI
20201260291	GOIANIA	10365783	CAMPINAS S1	11/12/2020 09:48	11/12/2020 11:52	11/12/2020 09:48	11/12/2020 11:52	2,06	1	2,06	CHI
20201260298	MINEIROS	MY11036154	PARQUE DAS EMAS	11/12/2020 09:49	12/12/2020 10:00	12/12/2020 09:49	12/12/2020 10:00	0,19	102	18,95	CHI
20201260299	CRIXAS	CX21246440	SANTA TEREZINHA	11/12/2020 09:49	11/12/2020 19:17	11/12/2020 09:49	11/12/2020 19:17	9,46	1	9,46	CHI
20201260306	PIRACANJUBA	PJ21287317	PIRACANJUBA	11/12/2020 09:50	11/12/2020 23:01	11/12/2020 09:50	11/12/2020 23:01	13,18	1	13,18	CHI
20201260314	SANTA HELENA DE GOIAS	400092074	IPEGUARI	11/12/2020 09:51	11/12/2020 23:27	11/12/2020 09:51	11/12/2020 23:27	13,59	1	13,59	CHI
20201260348	PALMEIRAS DE GOIAS	PL21259138	EDEIA	11/12/2020 09:51	11/12/2020 12:57	11/12/2020 09:51	11/12/2020 12:57	3,10	1	3,10	CHI
20201260320	SAO LUIS DE MONTES BELOS	SL21186363	SAO LUIZ DOS MONTES BELOS	11/12/2020 09:52	11/12/2020 11:40	11/12/2020 09:52	11/12/2020 11:40	1,80	1	1,80	CHI
20201260332	MATRINCHA	MP21064992	MATRINCHA	11/12/2020 09:53	12/12/2020 00:44	11/12/2020 09:53	12/12/2020 00:44	14,84	1	14,84	CHI
20201261336	CUMARI	CY12203050	CATALAO S1	11/12/2020 09:53	11/12/2020 16:04	11/12/2020 09:53	11/12/2020 16:04	6,18	13	80,29	CHI
20201260336	MAIRIPOTABA	10019559915	PONTALINA	11/12/2020 09:54	11/12/2020 18:12	11/12/2020 09:54	11/12/2020 18:12	8,30	1	8,30	CHI
20201260428	ITABERAI	IB12336256	ITABERAI S1	11/12/2020 09:54	11/12/2020 12:26	11/12/2020 09:54	11/12/2020 12:26	2,53	7	17,70	CHI
20201256508	SAO DOMINGOS	SD12383360	SAO DOMINGOS	11/12/2020 09:55	11/12/2020 10:36	11/12/2020 09:55	11/12/2020 10:36	0,68	28	18,92	CHI
20201256508	GUARANI DE GOIAS	SD12383360	SAO DOMINGOS	11/12/2020 09:55	11/12/2020 10:36	11/12/2020 09:55	11/12/2020 10:36	0,68	2	1,35	CHI
20201260353	GOIANIA	16371537	FERROVIARIO S1	11/12/2020 09:55	11/12/2020 15:52	11/12/2020 09:55	11/12/2020 15:52	5,94	1	5,94	CHI
20201260355	DAVINOPOLIS	IO21074886	CATALAO S1	11/12/2020 09:55	12/12/2020 00:24	11/12/2020 09:55	12/12/2020 00:24	14,47	1	14,47	CHI
20201261305	PALMEIRAS DE GOIAS	PL21233304	EDEIA	11/12/2020 09:55	11/12/2020 13:03	11/12/2020 09:55	11/12/2020 13:03	3,13	1	3,13	CHI
20201260357	FORMOSA	FA11245416	ITUIQUIRA	11/12/2020 09:56	11/12/2020 14:53	11/12/2020 09:56	11/12/2020 14:53	4,96	9	44,65	CHI
20201260373	CAMPINORTE	MQ12338206	MARA ROSA	11/12/2020 09:58	12/12/2020 01:38	11/12/2020 09:58	12/12/2020 01:38	15,65	0	0,00	CHI
20201260384	ALEXANIA	AX11000006	ALEXANIA	11/12/2020 09:58	11/12/2020 11:38	11/12/2020 09:58	11/12/2020 11:38	1,66	75	124,77	CHI
20201264142	CAMPINORTE	2040025413	MARA ROSA	11/12/2020 09:58	12/12/2020 02:35	11/12/2020 09:58	12/12/2020 02:35	16,60	1	16,60	CHI
20201262923	CAMPO ALEGRE DE GOIAS	CM12077548	CAMPO ALEGRE DE GOIAS	11/12/2020 09:59	11/12/2020 20:53	11/12/2020 09:59	11/12/2020 20:53	10,90	6	65,40	CHI
20201260392	PALMEIRAS DE GOIAS	TV12005723	FIRMINOPOLIS S2	11/12/2020 10:01	11/12/2020 11:24	11/12/2020 10:01	11/12/2020 11:24	1,38	4	5,53	CHI
20201260393	PIRACANJUBA	PJ12000082	PIRACANJUBA	11/12/2020 10:01	12/12/2020 08:59	11/12/2020 10:01	12/12/2020 08:59	22,96	4	91,86	CHI
20201260399	APORE	AE21154106	ITAJA S1	11/12/2020 10:01	11/12/2020 18:43	11/12/2020 10:01	11/12/2020 18:43	8,69	2	17,38	CHI
20201260411	CRISTALINA	KR11184825	CRISTALINA S1	11/12/2020 10:02	11/12/2020 11:40	11/12/2020 10:02	11/12/2020 11:40	1,63	1	1,63	CHI
20201260417	ANAPOLIS	AN21353204	ANAPOLIS UNIVERSITARIO S1	11/12/2020 10:03	11/12/2020 12:46	11/12/2020 10:03	11/12/2020 12:46	2,71	1	2,71	CHI
20201260423	TRINDADE	10013325530	TRINDADE	11/12/2020 10:04	11/12/2020 14:03	11/12/2020 10:04	11/12/2020 14:03	3,97	1	3,97	CHI
20201260435	MINEIROS	PW21200609	PARQUE DAS EMAS	11/12/2020 10:06	11/12/2020 13:59	11/12/2020 10:06	11/12/2020 13:59	3,87	1	3,87	CHI
20201260437	NOVA ROMA	ND21327507	IACIARA S2	11/12/2020 10:06	11/12/2020 18:58	11/12/2020 10:06	11/12/2020 18:58	8,86	2	17,71	CHI
20201260439	LUZIANIA	LZ10404052	RIO VERMELHO	11/12/2020 10:06	12/12/2020 10:50	11/12/2020 12:32	11/12/2020 14:44	2,20	24	52,89	CHI
20201260439	LUZIANIA	LZ12056764LD	RIO VERMELHO	11/12/2020 10:06	12/12/2020 10:50	11/12/2020 12:32	11/12/2020 18:49	6,30	36	226,68	CHI
20201260439	LUZIANIA	LZ12110889	RIO VERMELHO	11/12/2020 10:06	12/12/2020 10:50	11/12/2020 10:06	12/12/2020 10:27	24,34	5	121,69	CHI
20201260439	LUZIANIA	LZ12110889	RIO VERMELHO	11/12/2020 10:06	12/12/2020 10:50	11/12/2020 10:06	12/12/2020 10:50	24,73	1	24,73	CHI
20201260439	LUZIANIA	LZ12110889	RIO VERMELHO	11/12/2020 10:06	12/12/2020 10:50	11/12/2020 16:52	12/12/2020 10:50	17,98	1	17,98	CHI
20201260439	LUZIANIA	LZ12110889	RIO VERMELHO	11/12/2020 10:06	12/12/2020 10:50	12/12/2020 10:38	12/12/2020 10:50	0,20	5	0,99	CHI
20201260440	PROFESSOR JAMIL SAFADY	PJ21357803	ROCHEDO	11/12/2020 10:06	11/12/2020 14:38	11/12/2020 10:06	11/12/2020 14:38	4,52	2	9,04	CHI
20201260614	JUSSARA	JR12114079	BRITANIA	11/12/2020 10:06	11/12/2020 15:31	11/12/2020 10:06	11/12/2020 15:31	5,41	2	10,82	CHI
20201260442	CIDADE OCIDENTAL	DH11324645	MARAJOARA	11/12/2020 10:07	11/12/2020 11:47	11/12/2020 10:07	11/12/2020 11:47	1,66	34	56,44	CHI
20201261641	GOIAS	GS12071261	GOIAS	11/12/2020 10:07	11/12/2020 17:28	11/12/2020 10:07	11/12/2020 17:28	7,33	7	51,34	CHI
20201260445	APARECIDA DE GOIANIA	200072274	INDEPENDENCIA S1	11/12/2020 10:08	11/12/2020 12:05	11/12/2020 10:08	11/12/2020 12:05	1,95	1	1,95	CHI
20201260454	EDEIA	EA21128596	EDEIA	11/12/2020 10:08	11/12/2020 11:49	11/12/2020 10:08	11/12/2020 11:49	1,68	1	1,68	CHI

20201261111	ABADIANIA	AN12001083	ANAPOLIS UNIVERSITARIO S2	11/12/2020 10:08	11/12/2020 20:07	11/12/2020 10:08	11/12/2020 20:07	9,97	31	309,11	CHI
20201260459	GOIANIA	AP11008303	CEPAIGO S1	11/12/2020 10:09	11/12/2020 11:52	11/12/2020 10:09	11/12/2020 11:52	1,71	58	99,28	CHI
20201260470	MORRINHOS	MR21000079	MORRINHOS	11/12/2020 10:10	11/12/2020 13:52	11/12/2020 10:10	11/12/2020 13:52	3,69	1	3,69	CHI
20201260472	PALESTINA DE GOIAS	PY21240390	PALESTINA	11/12/2020 10:11	11/12/2020 14:51	11/12/2020 10:11	11/12/2020 14:51	4,66	1	4,66	CHI
20201260473	JARAGUA	70042986	JARAGUA	11/12/2020 10:11	12/12/2020 13:16	11/12/2020 10:11	12/12/2020 13:16	27,08	1	27,08	CHI
20201260474	MONTIVIDIU	MV21075508	MONTIVIDIU T	11/12/2020 10:11	11/12/2020 11:44	11/12/2020 10:11	11/12/2020 11:44	1,54	1	1,54	CHI
20201260476	MONTES CLAROS DE GOIAS	ME12204903	IPORA	11/12/2020 10:11	11/12/2020 15:44	11/12/2020 10:11	11/12/2020 15:44	5,54	3	16,61	CHI
20201260477	JATAI	JT21136074	JATAI S1	11/12/2020 10:11	11/12/2020 13:44	11/12/2020 10:11	11/12/2020 13:44	3,53	1	3,53	CHI
20201260481	APARECIDA DE GOIANIA	10012864780	INDEPENDENCIA S2	11/12/2020 10:13	11/12/2020 11:10	11/12/2020 10:13	11/12/2020 11:10	0,95	1	0,95	CHI
20201260485	RIO VERDE	630477292	RIO VERDE S1	11/12/2020 10:13	11/12/2020 14:58	11/12/2020 10:13	11/12/2020 14:58	4,74	1	4,74	CHI
20201260486	LUZIANIA	120257774	RIO VERMELHO	11/12/2020 10:13	11/12/2020 10:56	11/12/2020 10:13	11/12/2020 10:56	0,71	1	0,71	CHI
20201261708	SAO JOAO D ALIANCA	JL12049201	SAO JOAO D ALIANCA	11/12/2020 10:14	11/12/2020 14:21	11/12/2020 10:14	11/12/2020 14:21	4,11	95	390,79	CHI
20201260502	MONTES CLAROS DE GOIAS	2700001686	IPORA	11/12/2020 10:15	11/12/2020 13:44	11/12/2020 10:15	11/12/2020 13:44	3,48	1	3,48	CHI
20201260698	PALMINOPOLIS	PP12118035	PALMEIRAS	11/12/2020 10:15	11/12/2020 19:13	11/12/2020 10:15	11/12/2020 19:13	8,95	7	62,68	CHI
20201261515	PALMINOPOLIS	PP12259881	PALMEIRAS	11/12/2020 10:15	11/12/2020 18:19	11/12/2020 10:15	11/12/2020 18:19	8,06	6	48,37	CHI
20201260518	CAIAPONIA	MV12267740	MONTIVIDIU T	11/12/2020 10:16	11/12/2020 12:34	11/12/2020 10:16	11/12/2020 12:34	2,29	11	25,17	CHI
20201260518	MONTIVIDIU	MV12267740	MONTIVIDIU T	11/12/2020 10:16	11/12/2020 12:34	11/12/2020 10:16	11/12/2020 12:34	2,29	1	2,29	CHI
20201260519	RIO VERDE	RV12305777	CABRIUVA S2	11/12/2020 10:16	11/12/2020 11:29	11/12/2020 10:16	11/12/2020 11:29	1,20	2	2,41	CHI
20201261377	SERRANOPOLIS	SX12260308	JATAI S1	11/12/2020 10:16	11/12/2020 18:49	11/12/2020 10:16	11/12/2020 18:49	8,54	7	59,78	CHI
20201260525	ANAPOLIS	AN11135844	ANAPOLIS UNIVERSITARIO S2	11/12/2020 10:17	11/12/2020 12:43	11/12/2020 10:17	11/12/2020 12:43	2,43	107	259,86	CHI
20201260765	PADRE BERNARDO	PB12163212	PADRE BERNARDO	11/12/2020 10:17	11/12/2020 12:42	11/12/2020 10:17	11/12/2020 12:42	2,41	23	55,32	CHI
20201260537	RIO VERDE	630153097	RIO VERDE S1	11/12/2020 10:18	11/12/2020 15:34	11/12/2020 10:18	11/12/2020 15:34	5,26	1	5,26	CHI
20201260546	JATAI	290151041	JATAI S2	11/12/2020 10:19	11/12/2020 20:50	11/12/2020 10:19	11/12/2020 20:50	10,50	1	10,50	CHI
20201260918	IPORA	IR12207857	IPORA	11/12/2020 10:20	11/12/2020 15:45	11/12/2020 10:20	11/12/2020 15:45	5,40	13	70,21	CHI
20201260554	FAINA	FC21237757	GOIAS	11/12/2020 10:21	11/12/2020 14:16	11/12/2020 10:21	11/12/2020 14:16	3,92	1	3,92	CHI
20201260560	APARECIDA DE GOIANIA	15102294	ATLANTICO S2	11/12/2020 10:22	11/12/2020 12:13	11/12/2020 10:22	11/12/2020 12:13	1,84	1	1,84	CHI
20201260561	URUACU	UR21222633	URUACU	11/12/2020 10:22	11/12/2020 13:05	11/12/2020 10:22	11/12/2020 13:05	2,71	1	2,71	CHI
20201260563	GOIATUBA	GT21346874	RIO DOS BOIS	11/12/2020 10:23	12/12/2020 08:52	11/12/2020 10:23	12/12/2020 08:52	22,48	1	22,48	CHI
20201260567	GOIANIA	10070977	CAMPINAS S1	11/12/2020 10:24	11/12/2020 15:02	11/12/2020 10:24	11/12/2020 15:02	4,63	1	4,63	CHI
20201260569	FORMOSA	10006550396	ITUIQUIRA	11/12/2020 10:24	11/12/2020 13:51	11/12/2020 10:24	11/12/2020 13:51	3,44	1	3,44	CHI
20201260579	GOIANIA	200598193	INDEPENDENCIA S2	11/12/2020 10:26	11/12/2020 14:47	11/12/2020 10:26	11/12/2020 14:47	4,35	1	4,35	CHI
20201261281	SANTA ROSA DE GOIAS	SR12019030	INHUMAS S1	11/12/2020 10:27	11/12/2020 23:14	11/12/2020 10:27	11/12/2020 23:14	12,78	16	204,48	CHI
20201261281	TAQUARAL DE GOIAS	SR12019030	INHUMAS S1	11/12/2020 10:27	11/12/2020 23:14	11/12/2020 10:27	11/12/2020 23:14	12,78	12	153,36	CHI
20201260593	QUIRINOPOLIS	QI12189210	QUIRINOPOLIS	11/12/2020 10:28	11/12/2020 11:53	11/12/2020 10:28	11/12/2020 11:53	1,40	4	5,61	CHI
20201260602	CACHOEIRA DOURADA	CD21000001	CACHOEIRA DOURADA	11/12/2020 10:30	11/12/2020 12:50	11/12/2020 10:30	11/12/2020 12:50	2,32	2	4,65	CHI
20201264038	TAQUARAL DE GOIAS	TQ12019064	INHUMAS S1	11/12/2020 10:30	11/12/2020 23:53	11/12/2020 10:30	11/12/2020 23:53	13,38	11	147,20	CHI
20201260609	APARECIDA DE GOIANIA	AP11203596	INDEPENDENCIA S2	11/12/2020 10:31	11/12/2020 12:54	11/12/2020 10:31	11/12/2020 12:54	2,37	153	362,69	CHI
20201260610	APARECIDA DE GOIANIA	200359125	INDEPENDENCIA S2	11/12/2020 10:31	11/12/2020 11:46	11/12/2020 10:31	11/12/2020 11:46	1,24	1	1,24	CHI
20201260613	PORANGATU	PO21230438	NOVO PLANALTO	11/12/2020 10:32	11/12/2020 13:14	11/12/2020 10:32	11/12/2020 13:14	2,70	1	2,70	CHI
20201260617	PIRACANJUBA	PJ21000004	PIRACANJUBA	11/12/2020 10:32	11/12/2020 23:32	11/12/2020 10:32	11/12/2020 23:32	12,99	1	12,99	CHI
20201260626	CATALAO	CT11023027	CATALAO S2	11/12/2020 10:34	11/12/2020 11:08	11/12/2020 10:34	11/12/2020 11:08	0,56	152	85,08	CHI
20201260628	PALMINOPOLIS	PP21372127	FIRMINOPOLIS S2	11/12/2020 10:34	12/12/2020 09:47	11/12/2020 10:34	12/12/2020 09:47	23,21	1	23,21	CHI
20201260638	FORMOSA	610010748	ITUIQUIRA	11/12/2020 10:35	11/12/2020 15:39	11/12/2020 10:35	11/12/2020 15:39	5,05	1	5,05	CHI
20201260955	MUTUNOPOLIS	MU12214693	MARA ROSA	11/12/2020 10:35	11/12/2020 12:47	11/12/2020 10:35	11/12/2020 12:47	2,20	9	19,79	CHI
20201261117	JATAI	JT12072427	JATAI S1	11/12/2020 10:35	12/12/2020 09:02	11/12/2020 10:35	12/12/2020 09:02	22,44	4	89,78	CHI
20201260640	ANICUNS	910051999	ANICUNS	11/12/2020 10:36	11/12/2020 13:48	11/12/2020 10:36	11/12/2020 13:48	3,20	1	3,20	CHI
20201260641	CABECEIRAS	CW21344407	ITUIQUIRA	11/12/2020 10:36	11/12/2020 14:29	11/12/2020 10:36	11/12/2020 14:29	3,88	2	7,76	CHI
20201260643	APARECIDA DE GOIANIA	AP12414498	ANHANGUERA	11/12/2020 10:36	11/12/2020 12:02	11/12/2020 10:36	11/12/2020 12:02	1,42	42	59,83	CHI
20201260647	APARECIDA DE GOIANIA	10002933908	REAL S1	11/12/2020 10:36	11/12/2020 14:00	11/12/2020 10:36	11/12/2020 14:00	3,39	1	3,39	CHI
20201260648	CATALAO	CT11000069	CATALAO S2	11/12/2020 10:36	11/12/2020 15:32	11/12/2020 10:36	11/12/2020 15:32	4,92	144	708,28	CHI
20201260649	PIRACANJUBA	PJ12249876	PIRACANJUBA	11/12/2020 10:37	11/12/2020 17:57	11/12/2020 10:37	11/12/2020 17:57	7,33	37	271,10	CHI

20201261413	PIRACANJUBA	PJ12263230	CALDAS NOVAS S1	11/12/2020 10:37	11/12/2020 17:01	11/12/2020 10:37	11/12/2020 17:01	6,39	17	108,63	CHI
20201261413	CALDAS NOVAS	PJ12263230	CALDAS NOVAS S1	11/12/2020 10:37	11/12/2020 17:01	11/12/2020 10:37	11/12/2020 17:01	6,39	1	6,39	CHI
20201260654	NOVA AURORA	NE21082762	CATALAO S1	11/12/2020 10:38	11/12/2020 19:14	11/12/2020 10:38	11/12/2020 19:14	8,60	1	8,60	CHI
20201260655	COCALZINHO DE GOIAS	9970028734	AGUAS LINDAS DE GOIAS S2	11/12/2020 10:38	11/12/2020 12:42	11/12/2020 10:38	11/12/2020 12:42	2,06	1	2,06	CHI
20201262238	ORIZONA	OZ12300550	PIRES DO RIO S2	11/12/2020 10:38	11/12/2020 17:26	11/12/2020 10:38	11/12/2020 17:26	6,80	53	360,27	CHI
20201260667	URUACU	UR12398066	CAMPINORTE	11/12/2020 10:40	11/12/2020 22:37	11/12/2020 10:40	11/12/2020 22:37	11,94	6	71,66	CHI
20201260668	NOVO PLANALTO	TA12358155	SAO MIGUEL DO ARAGUAIA	11/12/2020 10:40	11/12/2020 13:15	11/12/2020 10:40	11/12/2020 13:15	2,58	16	41,20	CHI
20201261759	MINACU	IH12348089	MINACU	11/12/2020 10:41	12/12/2020 00:05	11/12/2020 10:41	12/12/2020 00:05	13,39	12	160,67	CHI
20201260676	GOIANIA	16715330	CARAJAS S1	11/12/2020 10:42	11/12/2020 15:00	11/12/2020 10:42	11/12/2020 15:00	4,30	1	4,30	CHI
20201260677	BOM JESUS DE GOIAS	BJ12198549	BOM JESUS DE GOIAS	11/12/2020 10:42	11/12/2020 12:48	11/12/2020 10:42	11/12/2020 12:48	2,10	8	16,77	CHI
20201255699	CAMPINACU	IH13052553	MINACU	11/12/2020 10:43	11/12/2020 22:55	11/12/2020 13:06	11/12/2020 22:55	9,80	29	284,25	CHI
20201255699	MINACU	IH13052553	MINACU	11/12/2020 10:43	11/12/2020 22:55	11/12/2020 13:06	11/12/2020 22:55	9,80	351	3440,39	CHI
20201255699	MINACU	IH13052553	MINACU	11/12/2020 10:43	11/12/2020 22:55	11/12/2020 19:41	11/12/2020 22:55	3,23	6	19,37	CHI
20201260688	CIDADE OCIDENTAL	2680026282	MARAJOARA	11/12/2020 10:43	11/12/2020 12:16	11/12/2020 10:43	11/12/2020 12:16	1,54	1	1,54	CHI
202012179350	MOZARLANDIA	MZ21055662	MOZARLANDIA	11/12/2020 10:43	11/12/2020 19:50	11/12/2020 10:43	11/12/2020 19:50	9,12	2	18,24	CHI
20201260696	HIDROLINA	HL21233264	ITAPACI	11/12/2020 10:44	11/12/2020 15:00	11/12/2020 10:44	11/12/2020 15:00	4,26	1	4,26	CHI
20201260697	MINEIROS	1390167188	PARQUE DAS EMAS	11/12/2020 10:44	12/12/2020 07:33	11/12/2020 10:44	12/12/2020 07:33	20,81	1	20,81	CHI
20201260699	FLORES DE GOIAS	FB12325413	FLORES DE GOIAS	11/12/2020 10:44	11/12/2020 11:16	11/12/2020 10:44	11/12/2020 11:16	0,52	1	0,52	CHI
20201261401	MOZARLANDIA	MZ18055650TS	MOZARLANDIA	11/12/2020 10:44	11/12/2020 16:27	11/12/2020 10:44	11/12/2020 16:27	5,71	5	28,55	CHI
20201261401	NOVA CRIXAS	MZ18055650TS	MOZARLANDIA	11/12/2020 10:44	11/12/2020 16:27	11/12/2020 10:44	11/12/2020 16:27	5,71	28	159,90	CHI
20201261401	CRIXAS	MZ18055650TS	MOZARLANDIA	11/12/2020 10:44	11/12/2020 16:27	11/12/2020 10:44	11/12/2020 16:27	5,71	73	416,89	CHI
20201260700	VALPARAISO DE GOIAS	10002773188	PACAEMBU S1	11/12/2020 10:45	11/12/2020 12:03	11/12/2020 10:45	11/12/2020 12:03	1,29	1	1,29	CHI
20201260701	SENADOR CANEDO	16112489	SENADOR CANEDO	11/12/2020 10:45	11/12/2020 11:51	11/12/2020 10:45	11/12/2020 11:51	1,09	1	1,09	CHI
20201260703	PIRES DO RIO	PR12083163	PIRES DO RIO S1	11/12/2020 10:45	12/12/2020 01:09	11/12/2020 10:45	12/12/2020 01:09	14,39	5	71,94	CHI
20201260704	QUIRINOPOLIS	10014843534	QUIRINOPOLIS	11/12/2020 10:45	11/12/2020 12:50	11/12/2020 10:45	11/12/2020 12:50	2,07	1	2,07	CHI
20201260706	SANTA HELENA DE GOIAS	SH11393317	IPEGUARI	11/12/2020 10:45	12/12/2020 00:04	11/12/2020 10:45	11/12/2020 23:53	13,13	4	52,51	CHI
20201260706	SANTA HELENA DE GOIAS	SH12393309	IPEGUARI	11/12/2020 10:45	12/12/2020 00:04	11/12/2020 21:32	12/12/2020 00:04	2,53	11	27,79	CHI
20201260709	ANAPOLIS	AN21362290	ANAPOLIS UNIVERSITARIO S1	11/12/2020 10:46	11/12/2020 12:19	11/12/2020 10:46	11/12/2020 12:19	1,55	1	1,55	CHI
20201260715	PONTALINA	PK12070376	PONTALINA	11/12/2020 10:46	11/12/2020 21:39	11/12/2020 10:46	11/12/2020 21:39	10,87	3	32,61	CHI
20201260846	BALIZA	BH12358780	BOM JARDIM	11/12/2020 10:46	11/12/2020 12:52	11/12/2020 10:46	11/12/2020 12:52	2,10	16	33,59	CHI
20201260719	PORANGATU	PO21361685	PORANGATU	11/12/2020 10:47	11/12/2020 15:44	11/12/2020 10:47	11/12/2020 15:44	4,94	1	4,94	CHI
20201260722	CALDAS NOVAS	760109473	SERRA DE CALDAS	11/12/2020 10:47	11/12/2020 18:02	11/12/2020 10:47	11/12/2020 18:02	7,23	1	7,23	CHI
20201260726	FORMOSA	610278204	ITUIQUIRA	11/12/2020 10:48	11/12/2020 13:48	11/12/2020 10:48	11/12/2020 13:48	2,99	1	2,99	CHI
20201260731	FORMOSA	10028656227	ITUIQUIRA	11/12/2020 10:49	11/12/2020 11:44	11/12/2020 10:49	11/12/2020 11:44	0,92	1	0,92	CHI
20201260733	HIDROLANDIA	HD11313034	CEPAIGO S2	11/12/2020 10:49	11/12/2020 23:53	11/12/2020 10:49	11/12/2020 23:53	13,06	4	52,26	CHI
20201260734	DIORAMA	DI11023259	IPORA	11/12/2020 10:49	12/12/2020 11:12	12/12/2020 07:32	12/12/2020 11:12	3,66	111	406,54	CHI
20201260737	BARRO ALTO	10016091610	BARRO ALTO	11/12/2020 10:49	12/12/2020 15:17	11/12/2020 10:49	12/12/2020 15:17	28,46	1	28,46	CHI
20201260744	LUZIANIA	LZ11164911	VIANOPOLIS	11/12/2020 10:50	11/12/2020 13:05	11/12/2020 10:50	11/12/2020 13:05	2,24	1	2,24	CHI
20201260746	ANAPOLIS	20640640	JUNDIAI S2	11/12/2020 10:50	11/12/2020 12:37	11/12/2020 10:50	11/12/2020 12:37	1,77	1	1,77	CHI
20201260752	PARAUNA	PU21203970	PARAUNA	11/12/2020 10:52	11/12/2020 14:36	11/12/2020 10:52	11/12/2020 14:36	3,73	1	3,73	CHI
20201260754	CATALAO	CT12399870	CATALAO S1	11/12/2020 10:53	11/12/2020 17:06	11/12/2020 10:53	11/12/2020 17:06	6,22	13	80,80	CHI
20201260758	ACREUNA	EU21260916	ACREUNA	11/12/2020 10:53	11/12/2020 14:14	11/12/2020 10:53	11/12/2020 14:14	3,34	1	3,34	CHI
20201260760	GOIANIA	12623581	CAMPINAS S1	11/12/2020 10:53	11/12/2020 15:15	11/12/2020 10:53	11/12/2020 15:15	4,36	1	4,36	CHI
20201260771	PALMEIRAS DE GOIAS	PL12000065	PALMEIRAS	11/12/2020 10:53	11/12/2020 20:01	11/12/2020 10:53	11/12/2020 20:01	9,12	9	82,07	CHI
20201260774	LUZIANIA	LZ11164911	PIRES DO RIO S2	11/12/2020 10:55	12/12/2020 01:36	11/12/2020 10:55	12/12/2020 01:36	14,67	126	1848,94	CHI
20201260775	FORMOSA	610235369	ITUIQUIRA	11/12/2020 10:55	11/12/2020 12:41	11/12/2020 10:55	11/12/2020 12:41	1,76	1	1,76	CHI
20201260866	PIRES DO RIO	PR12064889LD	PIRES DO RIO S1	11/12/2020 10:56	11/12/2020 11:48	11/12/2020 10:56	11/12/2020 11:48	0,86	865	741,98	CHI
20201260792	PIRENOPOLIS	PV21382854	CORUMBA	11/12/2020 10:57	11/12/2020 15:47	11/12/2020 10:57	11/12/2020 15:47	4,82	2	9,64	CHI
20201261599	ANAPOLIS	AN11127763	JUNDIAI S2	11/12/2020 10:57	11/12/2020 17:47	11/12/2020 10:57	11/12/2020 17:47	6,82	71	484,44	CHI
20201260807	SAO MIGUEL DO ARAGUAIA	SM11000020	SAO MIGUEL DO ARAGUAIA	11/12/2020 11:00	11/12/2020 17:18	11/12/2020 11:00	11/12/2020 17:18	6,28	94	590,76	CHI
20201260816	SERRANOPOLIS	SX12390577	JATAI S1	11/12/2020 11:03	12/12/2020 12:14	11/12/2020 11:03	12/12/2020 12:14	25,18	6	151,08	CHI

20201260820	PORTEIRAO	2470005857	RIO DOS BOIS	11/12/2020 11:04	11/12/2020 16:29	11/12/2020 11:04	11/12/2020 16:29	5,42	1	5,42	CHI
20201260830	JATAI	JT21319343	JATAI S2	11/12/2020 11:04	11/12/2020 13:57	11/12/2020 11:04	11/12/2020 13:57	2,87	1	2,87	CHI
20201260977	PILAR DE GOIAS	GG12353572	SANTA TEREZINHA	11/12/2020 11:05	11/12/2020 16:47	11/12/2020 11:05	11/12/2020 16:47	5,70	2	11,39	CHI
20201260837	LUZIANIA	LZ21335899	MARAJOARA	11/12/2020 11:06	11/12/2020 14:13	11/12/2020 11:06	11/12/2020 14:13	3,11	1	3,11	CHI
20201260841	ANAPOLIS	AN21262482	ANAPOLIS UNIVERSITARIO S1	11/12/2020 11:06	12/12/2020 00:27	11/12/2020 11:06	12/12/2020 00:27	13,34	1	13,34	CHI
20201260847	SANTA HELENA DE GOIAS	400114483	IPEGUARI	11/12/2020 11:07	11/12/2020 14:03	11/12/2020 11:07	11/12/2020 14:03	2,92	1	2,92	CHI
20201260848	TRINDADE	40095149	TRINDADE	11/12/2020 11:07	11/12/2020 12:06	11/12/2020 11:07	11/12/2020 12:06	0,98	1	0,98	CHI
20201261063	CAMPINACU	UC12239716	PORANGATU	11/12/2020 11:09	11/12/2020 13:50	11/12/2020 11:09	11/12/2020 13:50	2,68	36	96,57	CHI
20201262519	GUARANI DE GOIAS	GY12267998	IACIARA S1	11/12/2020 11:09	11/12/2020 17:21	11/12/2020 11:09	11/12/2020 17:21	6,19	16	99,04	CHI
20201260868	TRES RANCHOS	2170002450	CATALAO S1	11/12/2020 11:11	11/12/2020 18:22	11/12/2020 11:11	11/12/2020 18:22	7,18	1	7,18	CHI
20201260870	PLANALTINA	2960028140	PLANALTINA	11/12/2020 11:11	11/12/2020 13:57	11/12/2020 11:11	11/12/2020 13:57	2,76	1	2,76	CHI
20201261015	LUZIANIA	LZ12330544	MARAJOARA	11/12/2020 11:11	11/12/2020 16:44	11/12/2020 11:11	11/12/2020 16:44	5,55	8	44,40	CHI
20201260876	SILVANIA	SV21196584	VIANOPOLIS	11/12/2020 11:13	12/12/2020 14:17	11/12/2020 11:13	12/12/2020 14:17	27,06	2	54,13	CHI
20201261913	AMORINOPOLIS	IR12091436	IPORA	11/12/2020 11:14	11/12/2020 15:45	11/12/2020 11:14	11/12/2020 15:45	4,51	3	13,53	CHI
20201261913	IPORA	IR12091436	IPORA	11/12/2020 11:14	11/12/2020 15:45	11/12/2020 11:14	11/12/2020 15:45	4,51	5	22,55	CHI
20201260922	PARAUNA	PU21318235	PARAUNA	11/12/2020 11:15	11/12/2020 16:04	11/12/2020 11:15	11/12/2020 16:04	4,82	1	4,82	CHI
20201260925	CAMPO ALEGRE DE GOIAS	1160019360	CAMPO ALEGRE DE GOIAS	11/12/2020 11:15	11/12/2020 14:17	11/12/2020 11:15	11/12/2020 14:17	3,02	1	3,02	CHI
20201260937	MINACU	4020119741	MINACU	11/12/2020 11:17	12/12/2020 00:46	11/12/2020 11:17	12/12/2020 00:46	13,48	1	13,48	CHI
20201261120	PIRES DO RIO	PR12000096RE	PIRES DO RIO S1	11/12/2020 11:17	11/12/2020 15:53	11/12/2020 11:17	11/12/2020 15:53	4,59	22	101,00	CHI
20201261120	PALMELO	PR12000096RE	PIRES DO RIO S1	11/12/2020 11:17	11/12/2020 15:53	11/12/2020 11:17	11/12/2020 15:53	4,59	6	27,55	CHI
20201260940	JUSSARA	JR21313201	JUSSARA	11/12/2020 11:18	11/12/2020 17:10	11/12/2020 11:18	11/12/2020 17:10	5,87	1	5,87	CHI
20201260944	RIO VERDE	RV21231879	CACHOEIRA ALTA	11/12/2020 11:19	11/12/2020 13:51	11/12/2020 11:19	11/12/2020 13:51	2,53	1	2,53	CHI
20201261100	FIRMINOPOLIS	FR12096758	FIRMINOPOLIS S1	11/12/2020 11:19	11/12/2020 16:38	11/12/2020 11:19	11/12/2020 16:38	5,31	6	31,88	CHI
20201260949	LEOPOLDO DE BULHOES	LB21347831	CEPAIGO S2	11/12/2020 11:20	11/12/2020 17:36	11/12/2020 11:20	11/12/2020 17:36	6,25	1	6,25	CHI
20201260953	URUTAI	UT21075306	PIRES DO RIO S2	11/12/2020 11:21	11/12/2020 14:37	11/12/2020 11:21	11/12/2020 14:37	3,26	1	3,26	CHI
20201260962	APORE	3110010031	ITAJA S1	11/12/2020 11:22	11/12/2020 15:35	11/12/2020 11:22	11/12/2020 15:35	4,20	1	4,20	CHI
20201260964	SAO MIGUEL DO ARAGUAIA	SM12046407	SAO MIGUEL DO ARAGUAIA	11/12/2020 11:22	13/12/2020 11:24	11/12/2020 11:22	12/12/2020 13:16	25,89	4	103,55	CHI
20201260964	SAO MIGUEL DO ARAGUAIA	SM12046407	SAO MIGUEL DO ARAGUAIA	11/12/2020 11:22	13/12/2020 11:24	12/12/2020 13:19	12/12/2020 14:04	0,76	3	2,28	CHI
20201260964	SAO MIGUEL DO ARAGUAIA	SM12313436LD	SAO MIGUEL DO ARAGUAIA	11/12/2020 11:22	13/12/2020 11:24	12/12/2020 13:19	13/12/2020 09:37	20,30	1	20,30	CHI
20201260964	SAO MIGUEL DO ARAGUAIA	SM13380778	SAO MIGUEL DO ARAGUAIA	11/12/2020 11:22	13/12/2020 11:24	12/12/2020 14:13	13/12/2020 11:24	21,18	3	63,55	CHI
20201260965	ANAPOLIS	20742344	ANAPOLIS UNIVERSITARIO S2	11/12/2020 11:23	11/12/2020 20:53	11/12/2020 11:23	11/12/2020 20:53	9,50	1	9,50	CHI
20201260966	CATALAO	CT12195295	CATALAO S1	11/12/2020 11:23	11/12/2020 23:45	11/12/2020 11:23	11/12/2020 23:45	12,35	3	37,06	CHI
20201260968	OUVIDOR	10027806071	CATALAO S1	11/12/2020 11:24	11/12/2020 14:20	11/12/2020 11:24	11/12/2020 14:20	2,93	1	2,93	CHI
20201260976	BOM JESUS DE GOIAS	BJ12000256	BOM JESUS DE GOIAS	11/12/2020 11:25	12/12/2020 00:44	11/12/2020 11:25	12/12/2020 00:44	13,31	1	13,31	CHI
20201260979	ALVORADA DO NORTE	AQ21099891	IACIARA S2	11/12/2020 11:25	11/12/2020 19:44	11/12/2020 11:25	11/12/2020 19:44	8,31	1	8,31	CHI
20201260981	PARANAIGUARA	PC21277339	QUIRINOPOLIS	11/12/2020 11:25	11/12/2020 16:55	11/12/2020 11:25	11/12/2020 16:55	5,48	2	10,97	CHI
20201261123	BALIZA	BH12380942	BOM JARDIM	11/12/2020 11:25	12/12/2020 17:47	11/12/2020 11:25	12/12/2020 17:47	30,38	7	212,65	CHI
20201260982	ORIZONA	OZ21155583	VIANOPOLIS	11/12/2020 11:26	11/12/2020 17:06	11/12/2020 11:26	11/12/2020 17:06	5,67	1	5,67	CHI
20201260984	ABADIANIA	AA21122887	DAIA S2	11/12/2020 11:26	11/12/2020 18:22	11/12/2020 11:26	11/12/2020 18:22	6,93	1	6,93	CHI
20201260985	CATURAI	CK21066138	ARACU	11/12/2020 11:26	11/12/2020 21:58	11/12/2020 11:26	11/12/2020 21:58	10,52	1	10,52	CHI
20201262268	FORMOSA	FA12051040	ITUIQUIRA	11/12/2020 11:27	11/12/2020 19:29	11/12/2020 11:27	11/12/2020 19:29	8,02	11	88,27	CHI
20201261507	NEROPOLIS	NR12010422	NEROPOLIS S2	11/12/2020 11:30	11/12/2020 17:26	11/12/2020 11:30	11/12/2020 17:26	5,92	4	23,69	CHI
20201261006	SANTA FE DE GOIAS	RN12378892	BRITANIA	11/12/2020 11:31	11/12/2020 16:10	11/12/2020 11:31	11/12/2020 16:10	4,64	19	88,12	CHI
20201261013	ITABERAI	IB11336373	ITABERAI S2	11/12/2020 11:33	11/12/2020 13:57	11/12/2020 11:33	11/12/2020 13:57	2,39	43	102,69	CHI
20201261017	CUMARI	CY21287024	CATALAO S1	11/12/2020 11:34	11/12/2020 22:34	11/12/2020 11:34	11/12/2020 22:34	11,00	1	11,00	CHI
20201261022	POSSE	PS21206166	IACIARA S2	11/12/2020 11:35	11/12/2020 19:21	11/12/2020 11:35	11/12/2020 19:21	7,77	1	7,77	CHI
20201261025	SANTA CRUZ DE GOIAS	BC21031893	PIRES DO RIO S2	11/12/2020 11:35	11/12/2020 18:37	11/12/2020 11:35	11/12/2020 18:37	7,02	1	7,02	CHI
20201261233	APARECIDA DE GOIANIA	AP11315445	INDEPENDENCIA S2	11/12/2020 11:36	11/12/2020 13:29	11/12/2020 11:36	11/12/2020 13:29	1,87	178	332,71	CHI
20201261369	FLORES DE GOIAS	FB12286863	FLORES DE GOIAS	11/12/2020 11:37	11/12/2020 21:01	11/12/2020 11:37	11/12/2020 21:01	9,38	78	731,96	CHI
20201261041	GOIANIA	14880878	CAMPINAS S1	11/12/2020 11:38	11/12/2020 15:41	11/12/2020 11:38	11/12/2020 15:41	4,04	1	4,04	CHI
20201261053	GOIANIA	10032824910	GOYA S2	11/12/2020 11:40	11/12/2020 14:04	11/12/2020 11:40	11/12/2020 14:04	2,39	1	2,39	CHI

20201261061	GOIANIA	13943443	MEIA PONTE	11/12/2020 11:40	11/12/2020 15:29	11/12/2020 11:40	11/12/2020 15:29	3,82	1	3,82	CHI
20201261056	CALDAS NOVAS	RQ21196405	VILA CORUMBA	11/12/2020 11:41	11/12/2020 14:00	11/12/2020 11:41	11/12/2020 14:00	2,32	2	4,63	CHI
20201261064	CAMPO ALEGRE DE GOIAS	CM12192740	CAMPO ALEGRE DE GOIAS	11/12/2020 11:42	12/12/2020 09:59	11/12/2020 11:42	12/12/2020 09:59	22,28	5	111,41	CHI
20201261132	ALEXANIA	AX11000006	ALEXANIA	11/12/2020 11:46	11/12/2020 14:59	11/12/2020 11:46	11/12/2020 14:59	3,21	75	240,46	CHI
20201261091	CATALAO	CT21216928	CATALAO S1	11/12/2020 11:47	11/12/2020 16:42	11/12/2020 11:47	11/12/2020 16:42	4,92	1	4,92	CHI
20201261605	GOIAS	00880234	ITABERAI S2	11/12/2020 11:47	11/12/2020 15:06	11/12/2020 14:32	11/12/2020 14:41	0,14	108	14,85	CHI
20201261605	ITABERAI	00880234	ITABERAI S2	11/12/2020 11:47	11/12/2020 15:06	11/12/2020 14:32	11/12/2020 14:41	0,14	1209	166,24	CHI
20201261605	ITABERAI	00880234	ITABERAI S2	11/12/2020 11:47	11/12/2020 15:06	11/12/2020 14:32	11/12/2020 14:41	0,14	8232	1131,90	CHI
20201261605	ITABERAI	IB13410185	ITABERAI S2	11/12/2020 11:47	11/12/2020 15:06	11/12/2020 14:32	11/12/2020 15:06	0,57	52	29,55	CHI
20201261605	ITABERAI	IB11000012	ITABERAI S2	11/12/2020 11:47	11/12/2020 15:06	11/12/2020 11:47	11/12/2020 15:06	3,32	17	56,51	CHI
20201261098	EDEIA	1120031981	EDEIA	11/12/2020 11:48	12/12/2020 03:07	11/12/2020 11:48	12/12/2020 03:07	15,31	1	15,31	CHI
20201261103	RIO VERDE	RV12091878	MONTIVIDIU T	11/12/2020 11:49	12/12/2020 03:51	11/12/2020 11:49	12/12/2020 03:51	16,02	1	16,02	CHI
20201261106	CACU	CC12234294	CACHOEIRA ALTA	11/12/2020 11:50	11/12/2020 18:23	11/12/2020 11:50	11/12/2020 18:23	6,54	1	6,54	CHI
20201261114	APARECIDA DE GOIANIA	200252148	INDEPENDENCIA S1	11/12/2020 11:51	11/12/2020 15:04	11/12/2020 11:51	11/12/2020 15:04	3,22	1	3,22	CHI
20201261119	CACU	CC21357957	CACHOEIRA ALTA	11/12/2020 11:52	11/12/2020 15:02	11/12/2020 11:52	11/12/2020 15:02	3,17	1	3,17	CHI
20201261129	CACHOEIRA ALTA	CA21196168	CACHOEIRA ALTA	11/12/2020 11:53	11/12/2020 21:14	11/12/2020 11:53	11/12/2020 21:14	9,34	1	9,34	CHI
20201261161	GOIANIA	GN11199212	FERROVIARIO S2	11/12/2020 11:53	11/12/2020 14:46	11/12/2020 11:53	11/12/2020 14:46	2,88	69	198,80	CHI
20201261133	AGUAS LINDAS DE GOIAS	4830098157	AGUAS LINDAS DE GOIAS S1	11/12/2020 11:54	11/12/2020 13:30	11/12/2020 11:54	11/12/2020 13:30	1,59	1	1,59	CHI
20201261139	CRISTALINA	KR11276489	CRISTALINA S2	11/12/2020 11:54	11/12/2020 16:14	11/12/2020 11:54	11/12/2020 16:14	4,32	2	8,64	CHI
20201261187	CAMPINORTE	CR12070384	CAMPINORTE	11/12/2020 11:55	11/12/2020 14:58	11/12/2020 11:55	11/12/2020 14:58	3,04	8	24,29	CHI
20201261187	NOVA IGUACU DE GOIAS	CR12070384	CAMPINORTE	11/12/2020 11:55	11/12/2020 14:58	11/12/2020 11:55	11/12/2020 14:58	3,04	23	69,84	CHI
20201261149	ARAGUAPAZ	AZ21143381	MOZARLANDIA	11/12/2020 11:57	11/12/2020 13:36	11/12/2020 11:57	11/12/2020 13:36	1,64	1	1,64	CHI
20201261150	CAVALCANTE	CJ12063197	FLORES DE GOIAS	11/12/2020 11:57	11/12/2020 16:11	11/12/2020 11:57	11/12/2020 16:11	4,22	1	4,22	CHI
20201261162	RIO VERDE	RV21305667	CABRIUVA S2	11/12/2020 11:59	11/12/2020 17:21	11/12/2020 11:59	11/12/2020 17:21	5,36	1	5,36	CHI
20201262050	MONTIVIDIU	MV21260810	MONTIVIDIU T	11/12/2020 12:00	11/12/2020 21:57	11/12/2020 12:00	11/12/2020 21:57	9,94	1	9,94	CHI
20201261174	GOIANIA	16986714	MEIA PONTE	11/12/2020 12:01	11/12/2020 17:00	11/12/2020 12:01	11/12/2020 17:00	4,97	1	4,97	CHI
20201261175	NOVO BRASIL	1460009578	JUSSARA	11/12/2020 12:02	11/12/2020 21:40	11/12/2020 12:02	11/12/2020 21:40	9,63	1	9,63	CHI
20201261177	MONTIVIDIU DO NORTE	9660000904	PORANGATU	11/12/2020 12:02	11/12/2020 14:44	11/12/2020 12:02	11/12/2020 14:44	2,69	1	2,69	CHI
20201261183	GOIANIA	GN11000852	FERROVIARIO S2	11/12/2020 12:03	11/12/2020 14:48	11/12/2020 13:26	11/12/2020 14:48	1,37	110	150,36	CHI
20201261185	ANAPOLIS	AN12258705	ANAPOLIS UNIVERSITARIO S2	11/12/2020 12:04	11/12/2020 20:55	11/12/2020 12:04	11/12/2020 20:55	8,86	15	132,86	CHI
20201261191	PORANGATU	PO12202569	PORANGATU	11/12/2020 12:04	11/12/2020 16:00	11/12/2020 12:04	11/12/2020 16:00	3,92	7	27,42	CHI
20201261366	MUTUNOPOLIS	PO12360454	PORANGATU	11/12/2020 12:04	11/12/2020 13:42	11/12/2020 12:04	11/12/2020 13:42	1,62	34	55,00	CHI
20201261366	PORANGATU	PO12360454	PORANGATU	11/12/2020 12:04	11/12/2020 13:42	11/12/2020 12:04	11/12/2020 13:42	1,62	45	72,79	CHI
20201261806	MOSSAMEDES	MD12000195	FIRMINOPOLIS S2	11/12/2020 12:04	11/12/2020 15:35	11/12/2020 12:04	11/12/2020 15:35	3,50	4	14,01	CHI
20201261193	PLANALTINA	3890000482	PLANALTINA	11/12/2020 12:05	11/12/2020 13:57	11/12/2020 12:05	11/12/2020 13:57	1,86	1	1,86	CHI
20201261199	GOIAS	GS12307622	GOIAS	11/12/2020 12:06	11/12/2020 17:07	11/12/2020 12:06	11/12/2020 17:07	5,01	1	5,01	CHI
20201261204	MONTES CLAROS DE GOIAS	ME12251375	IPORA	11/12/2020 12:07	11/12/2020 16:34	11/12/2020 12:07	11/12/2020 16:34	4,44	7	31,06	CHI
20201261204	BOM JARDIM DE GOIAS	ME12251375	IPORA	11/12/2020 12:07	11/12/2020 16:34	11/12/2020 12:07	11/12/2020 16:34	4,44	18	79,87	CHI
20201261264	PIRES DO RIO	PR11186713	PIRES DO RIO S1	11/12/2020 12:07	11/12/2020 13:05	11/12/2020 12:07	11/12/2020 13:05	0,96	151	145,38	CHI
20201261210	LUZIANIA	3200127889	MARAJOARA	11/12/2020 12:08	11/12/2020 15:22	11/12/2020 12:08	11/12/2020 15:22	3,22	1	3,22	CHI
20201261569	MONTES CLAROS DE GOIAS	ME12244013	IPORA	11/12/2020 12:08	12/12/2020 13:18	11/12/2020 12:08	12/12/2020 13:18	25,16	11	276,74	CHI
20201261213	VIANOPOLIS	510051194	VIANOPOLIS	11/12/2020 12:09	11/12/2020 16:00	11/12/2020 12:09	11/12/2020 16:00	3,85	1	3,85	CHI
20201261216	MINACU	4020119285	MINACU	11/12/2020 12:10	11/12/2020 14:57	11/12/2020 12:10	11/12/2020 14:57	2,77	1	2,77	CHI
20201261218	PIRANHAS	PH12247806	ARENOPOLIS	11/12/2020 12:10	11/12/2020 15:55	11/12/2020 12:10	11/12/2020 15:55	3,73	7	26,14	CHI
20201261220	PADRE BERNARDO	PB21097179	PADRE BERNARDO	11/12/2020 12:11	11/12/2020 17:22	11/12/2020 12:11	11/12/2020 17:22	5,17	1	5,17	CHI
20201261221	NOVA GLORIA	NG21089691	ITAPACI	11/12/2020 12:12	11/12/2020 14:05	11/12/2020 12:12	11/12/2020 14:05	1,87	1	1,87	CHI
20201261223	HIDROLANDIA	HD12402110	INDEPENDENCIA S1	11/12/2020 12:13	11/12/2020 21:10	11/12/2020 12:13	11/12/2020 21:10	8,95	2	17,89	CHI
20201261225	MINACU	IH21182347	MINACU	11/12/2020 12:13	11/12/2020 23:11	11/12/2020 12:13	11/12/2020 23:11	10,95	15	164,30	CHI
20201261226	ARAGARCAS	1820051393	ARAGARCAS	11/12/2020 12:14	11/12/2020 14:01	11/12/2020 12:14	11/12/2020 14:01	1,78	1	1,78	CHI
20201261240	NIQUELANDIA	NQ12135523	URUACU	11/12/2020 12:14	11/12/2020 14:50	11/12/2020 12:14	11/12/2020 14:50	2,59	2	5,19	CHI
20201261229	ANAPOLIS	20592875	ANAPOLIS UNIVERSITARIO S2	11/12/2020 12:15	11/12/2020 20:04	11/12/2020 12:15	11/12/2020 20:04	7,82	1	7,82	CHI

20201261231	BELA VISTA DE GOIAS	BV12242076LD	BELA VISTA S1	11/12/2020 12:15	11/12/2020 20:38	11/12/2020 12:15	11/12/2020 20:38	8,39	25	209,71	CHI
20201261453	FLORADA DO NORTE	FB12143258	IACIARA S2	11/12/2020 12:15	11/12/2020 15:51	11/12/2020 12:15	11/12/2020 15:51	3,60	30	107,96	CHI
20201261453	FLORES DE GOIAS	FB12143258	IACIARA S2	11/12/2020 12:15	11/12/2020 15:51	11/12/2020 12:15	11/12/2020 15:51	3,60	27	97,16	CHI
20201261235	MARA ROSA	LC12308828	MARA ROSA	11/12/2020 12:16	11/12/2020 14:40	11/12/2020 12:16	11/12/2020 14:40	2,40	1	2,40	CHI
20201261235	AMARALINA	LC12308828	MARA ROSA	11/12/2020 12:16	11/12/2020 14:40	11/12/2020 12:16	11/12/2020 14:40	2,40	2	4,79	CHI
20201261236	NAZARIO	440023373	ANICUNS	11/12/2020 12:16	11/12/2020 16:26	11/12/2020 12:16	11/12/2020 16:26	4,15	1	4,15	CHI
20201261238	CACU	1140049097	CACHOEIRA ALTA	11/12/2020 12:17	12/12/2020 01:23	11/12/2020 12:17	12/12/2020 01:23	13,09	1	13,09	CHI
20201261638	CAMPO ALEGRE DE GOIAS	CM12358429	CAMPO ALEGRE DE GOIAS	11/12/2020 12:18	12/12/2020 17:34	11/12/2020 12:18	12/12/2020 17:34	29,25	3	87,75	CHI
20201262133	MINACU	IH122020680	MINACU	11/12/2020 12:18	13/12/2020 00:28	11/12/2020 12:18	13/12/2020 00:28	36,17	13	470,16	CHI
20201261247	SAO MIGUEL DO ARAGUAIA	SM11000017	SAO MIGUEL DO ARAGUAIA	11/12/2020 12:20	12/12/2020 11:05	12/12/2020 09:18	12/12/2020 11:05	1,78	99	176,44	CHI
20201261248	CIDADE OCIDENTAL	2680175937	MARAJOARA	11/12/2020 12:20	11/12/2020 13:27	11/12/2020 12:20	11/12/2020 13:27	1,12	1	1,12	CHI
20201266287	MONTES CLAROS DE GOIAS	ME12380972	IPORA	11/12/2020 12:20	12/12/2020 13:59	11/12/2020 12:20	12/12/2020 13:59	25,64	8	205,15	CHI
20201262511	DAMIANOPOLIS	DA21180676	IACIARA S2	11/12/2020 12:21	11/12/2020 19:44	11/12/2020 12:21	11/12/2020 19:44	7,38	1	7,38	CHI
20201261327	URUACU	UR12317135	URUACU	11/12/2020 12:22	11/12/2020 17:01	11/12/2020 12:22	11/12/2020 17:01	4,65	11	51,10	CHI
20201261265	PORTELANDIA	PW12331831	PARQUE DAS EMAS	11/12/2020 12:23	12/12/2020 14:15	11/12/2020 12:23	12/12/2020 14:15	25,87	1	25,87	CHI
20201261272	ANAPOLIS	10001659080	JUNDIAI S1	11/12/2020 12:24	11/12/2020 22:30	11/12/2020 12:24	11/12/2020 22:30	10,10	1	10,10	CHI
20201261273	ITUMBIARA	IT12304206	ITUMBIARA NOVA	11/12/2020 12:24	11/12/2020 18:13	11/12/2020 12:24	11/12/2020 18:13	5,80	1	5,80	CHI
20201261627	JATAI	JT1234889RE	JATAI S2	11/12/2020 12:25	12/12/2020 02:52	11/12/2020 12:25	12/12/2020 02:52	14,45	2	28,90	CHI
20201261282	DOVERLANDIA	DV11253421	CAIAPONIA	11/12/2020 12:26	11/12/2020 21:51	11/12/2020 12:26	11/12/2020 21:51	9,41	1	9,41	CHI
20201261283	GOIANESIA	GE11215134	GOIANESIA S2	11/12/2020 12:26	11/12/2020 15:44	11/12/2020 12:26	11/12/2020 15:44	3,29	79	259,82	CHI
20201261285	CAMPOS VERDES	VD12049788	SANTA TEREZINHA	11/12/2020 12:26	11/12/2020 18:37	11/12/2020 12:26	11/12/2020 18:37	6,17	1	6,17	CHI
20201261288	RIO VERDE	10031306282	CABRIUVA S1	11/12/2020 12:27	11/12/2020 20:17	11/12/2020 12:27	11/12/2020 20:17	7,83	1	7,83	CHI
20201261296	NOVA AURORA	NE12327244	CATALAO S1	11/12/2020 12:28	11/12/2020 19:51	11/12/2020 12:28	11/12/2020 19:51	7,37	2	14,74	CHI
20201261692	EDEIA	EA12000001	EDEIA	11/12/2020 12:28	11/12/2020 20:44	11/12/2020 12:28	11/12/2020 20:44	8,26	19	156,95	CHI
20201261626	ANAPOLIS	AN12000204LD	JUNDIAI S2	11/12/2020 12:29	11/12/2020 18:48	11/12/2020 12:29	11/12/2020 17:52	5,37	98	526,23	CHI
20201261626	ANAPOLIS	AN12000204LD	JUNDIAI S2	11/12/2020 12:29	11/12/2020 18:48	11/12/2020 18:38	11/12/2020 18:48	0,18	98	17,80	CHI
20201261302	SANTA FE DE GOIAS	RN12391528	BRITANIA	11/12/2020 12:30	11/12/2020 18:30	11/12/2020 12:30	11/12/2020 18:30	6,00	6	36,03	CHI
20201261306	GUAPO	3040002324	GUAPO S2	11/12/2020 12:31	11/12/2020 17:51	11/12/2020 12:31	11/12/2020 17:51	5,33	1	5,33	CHI
20201261311	TRINDADE	10024018030	GOYA S1	11/12/2020 12:32	11/12/2020 17:44	11/12/2020 12:32	11/12/2020 17:44	5,19	1	5,19	CHI
20201261316	PALMEIRAS DE GOIAS	PL11277547	PALMEIRAS	11/12/2020 12:33	11/12/2020 17:13	11/12/2020 12:33	11/12/2020 17:13	4,66	1	4,66	CHI
20201261322	CACHOEIRA DOURADA	IT21081122	CACHOEIRA DOURADA	11/12/2020 12:34	11/12/2020 21:35	11/12/2020 12:34	11/12/2020 21:35	9,01	1	9,01	CHI
20201261325	ARAGOIANIA	AO12092573	GUAPO S2	11/12/2020 12:34	11/12/2020 16:49	11/12/2020 12:34	11/12/2020 16:49	4,24	38	160,97	CHI
20201261325	APARECIDA DE GOIANIA	AO12092573	GUAPO S2	11/12/2020 12:34	11/12/2020 16:49	11/12/2020 12:34	11/12/2020 16:49	4,24	2	8,47	CHI
20201261671	CAVALCANTE	CJ12346073	MINACU	11/12/2020 12:34	11/12/2020 22:15	11/12/2020 12:34	11/12/2020 22:15	9,68	197	1906,14	CHI
20201261682	PETROLINA DE GOIAS	PG12216919	PETROLINA	11/12/2020 12:36	11/12/2020 16:55	11/12/2020 12:36	11/12/2020 16:55	4,31	9	38,82	CHI
20201261682	SAO FRANCISCO DE GOIAS	PG12216919	PETROLINA	11/12/2020 12:36	11/12/2020 16:55	11/12/2020 12:36	11/12/2020 16:55	4,31	1	4,31	CHI
20201261618	JARAGUA	JA12414669	JARAGUA	11/12/2020 12:37	11/12/2020 15:09	11/12/2020 12:37	11/12/2020 15:09	2,53	222	561,11	CHI
20201261350	ITAJA	IM10394710	CACHOEIRA ALTA	11/12/2020 12:38	12/12/2020 16:20	11/12/2020 12:38	12/12/2020 16:20	27,70	1	27,70	CHI
20201261350	SERRANOPOLIS	IM10394710	CACHOEIRA ALTA	11/12/2020 12:38	12/12/2020 16:20	11/12/2020 12:38	12/12/2020 16:20	27,70	51	1412,91	CHI
20201261350	ITARUMA	IM10394710	CACHOEIRA ALTA	11/12/2020 12:38	12/12/2020 16:20	11/12/2020 12:38	12/12/2020 16:20	27,70	123	3407,61	CHI
20201261350	JATAI	IM10394710	CACHOEIRA ALTA	11/12/2020 12:38	12/12/2020 16:20	11/12/2020 12:38	12/12/2020 16:20	27,70	12	332,45	CHI
20201263295	NOVA CRIXAS	NA12158757	NOVA CRIXAS	11/12/2020 12:39	12/12/2020 18:49	11/12/2020 12:39	12/12/2020 18:49	30,16	161	4855,13	CHI
20201261352	NOVO GAMA	LZ12000279	PACAEMBU S2	11/12/2020 12:40	11/12/2020 15:22	11/12/2020 12:40	11/12/2020 15:22	2,69	18	48,38	CHI
20201263176	PILAR DE GOIAS	GG12318429	URUACU	11/12/2020 12:40	11/12/2020 19:43	11/12/2020 12:40	11/12/2020 19:43	7,04	3	21,13	CHI
20201261707	FAINA	FC12038664	GOIAS	11/12/2020 12:41	11/12/2020 17:59	11/12/2020 12:41	11/12/2020 17:59	5,29	10	52,87	CHI
20201261358	NOVO GAMA	NJ1211976	PACAEMBU S2	11/12/2020 12:42	11/12/2020 13:59	11/12/2020 12:42	11/12/2020 13:59	1,28	15	19,25	CHI
20201261362	VIANOPOLIS	VN21060535	PIRES DO RIO S2	11/12/2020 12:43	11/12/2020 14:52	11/12/2020 12:43	11/12/2020 14:52	2,15	1	2,15	CHI
20201261385	IPAMERI	IP21300935	IPAMERI	11/12/2020 12:46	11/12/2020 14:28	11/12/2020 12:46	11/12/2020 14:28	1,69	1	1,69	CHI
20201261600	CAIAPONIA	CP12334953	CAIAPONIA	11/12/2020 12:46	11/12/2020 16:11	11/12/2020 12:46	11/12/2020 16:11	3,40	12	40,81	CHI
20201261390	AGUA LIMPA	430000273	VILA CORUMBA	11/12/2020 12:47	11/12/2020 18:22	11/12/2020 12:47	11/12/2020 18:22	5,57	1	5,57	CHI
20201261411	CABECEIRAS	CW21090893	ITUIQUIRA	11/12/2020 12:50	11/12/2020 17:47	11/12/2020 12:50	11/12/2020 17:47	4,94	1	4,94	CHI

20201261418	LUZIANIA	LZ12330887	RIO VERMELHO	11/12/2020 12:51	11/12/2020 14:33	11/12/2020 12:51	11/12/2020 14:33	1,70	137	232,60	CHI
20201261421	MORRINHOS	MR21038352	MORRINHOS	11/12/2020 12:51	11/12/2020 22:47	11/12/2020 12:51	11/12/2020 22:47	9,94	1	9,94	CHI
20201261440	GUARANI DE GOIAS	GY12195884	IACIARA S1	11/12/2020 12:51	11/12/2020 16:16	11/12/2020 12:51	11/12/2020 16:16	3,42	10	34,15	CHI
20201261439	APARECIDA DE GOIANIA	200068982	INDEPENDENCIA S1	11/12/2020 12:54	11/12/2020 15:48	11/12/2020 12:54	11/12/2020 15:48	2,90	1	2,90	CHI
20201261442	CALDAZINHA	LB21187214	DAIA S2	11/12/2020 12:54	11/12/2020 14:39	11/12/2020 12:54	11/12/2020 14:39	1,75	1	1,75	CHI
20201261444	JUSSARA	JR21250531	JUSSARA	11/12/2020 12:54	11/12/2020 16:28	11/12/2020 12:54	11/12/2020 16:28	3,56	1	3,56	CHI
20201261481	MONTIVIDIU	MV21147841	MONTIVIDIU T	11/12/2020 12:54	11/12/2020 20:19	11/12/2020 12:54	11/12/2020 20:19	7,41	1	7,41	CHI
20201261564	SILVANIA	SV12172117	DAIA S2	11/12/2020 12:54	11/12/2020 18:19	11/12/2020 12:54	11/12/2020 18:19	5,41	170	920,36	CHI
20201261564	BELA VISTA DE GOIAS	SV12172117	DAIA S2	11/12/2020 12:54	11/12/2020 18:19	11/12/2020 12:54	11/12/2020 18:19	5,41	8	43,31	CHI
20201261449	OURO VERDE DE GOIAS	OV12033148	NEROPOLIS S1	11/12/2020 12:55	11/12/2020 15:12	11/12/2020 12:55	11/12/2020 15:12	2,28	2	4,56	CHI
20201261449	CAMPO LIMPO	OV12033148	NEROPOLIS S1	11/12/2020 12:55	11/12/2020 15:12	11/12/2020 12:55	11/12/2020 15:12	2,28	2	4,56	CHI
20201261460	PIRACANJUBA	60049741	PIRACANJUBA	11/12/2020 12:56	11/12/2020 16:02	11/12/2020 12:56	11/12/2020 16:02	3,10	1	3,10	CHI
20201261463	AGUAS LINDAS DE GOIAS	SN21203230	AGUAS LINDAS DE GOIAS S1	11/12/2020 12:57	11/12/2020 19:06	11/12/2020 12:57	11/12/2020 18:42	5,76	2	11,52	CHI
20201261463	AGUAS LINDAS DE GOIAS	LA12290651LD	AGUAS LINDAS DE GOIAS S1	11/12/2020 12:57	11/12/2020 19:06	11/12/2020 15:36	11/12/2020 19:06	3,50	3	10,50	CHI
20201261466	PORANGATU	PO21150704	PORANGATU	11/12/2020 12:57	11/12/2020 13:57	11/12/2020 12:57	11/12/2020 13:57	1,00	1	1,00	CHI
20201261472	RUBIATABA	3710000371	RUBIATABA	11/12/2020 12:58	11/12/2020 19:57	11/12/2020 12:58	11/12/2020 19:57	6,97	1	6,97	CHI
20201261477	SANTO ANTONIO DA BARRA	BZ21196645	SANTA HELENA S1	11/12/2020 12:59	11/12/2020 23:54	11/12/2020 12:59	11/12/2020 23:54	10,91	1	10,91	CHI
20201261502	LUZIANIA	LZ11261051	RIO VERMELHO	11/12/2020 13:04	11/12/2020 17:30	11/12/2020 13:04	11/12/2020 17:30	4,42	150	663,04	CHI
20201261512	PORTELANDIA	PW21066469	PARQUE DAS EMAS	11/12/2020 13:05	11/12/2020 21:35	11/12/2020 13:05	11/12/2020 21:35	8,50	1	8,50	CHI
20201261513	MINEIROS	1390019140	PARQUE DAS EMAS	11/12/2020 13:05	12/12/2020 13:09	11/12/2020 13:05	12/12/2020 13:09	24,06	1	24,06	CHI
20201261736	SAO JOAO D ALIANCA	JL12268121	SAO JOAO D ALIANCA	11/12/2020 13:05	11/12/2020 18:05	11/12/2020 13:05	11/12/2020 18:05	4,99	8	39,90	CHI
20201261517	LAGOA SANTA	IJ21203986	ITAJA S2	11/12/2020 13:06	11/12/2020 17:14	11/12/2020 13:06	11/12/2020 17:14	4,12	1	4,12	CHI
20201262359	PETROLINA DE GOIAS	PG12297874	PETROLINA	11/12/2020 13:06	11/12/2020 19:10	11/12/2020 13:06	11/12/2020 19:10	6,07	14	84,92	CHI
20201264046	SANTA ROSA DE GOIAS	SR12019043	INHUMAS S1	11/12/2020 13:09	12/12/2020 00:13	11/12/2020 13:09	12/12/2020 00:13	11,07	3	33,20	CHI
20201261539	FAINA	FC12190720	GOIAS	11/12/2020 13:11	12/12/2020 08:06	11/12/2020 13:11	12/12/2020 08:06	18,91	4	75,62	CHI
20201261172	ORIZONA	OZ21159625	PIRES DO RIO S1	11/12/2020 13:13	11/12/2020 15:40	11/12/2020 13:13	11/12/2020 15:40	2,45	1	2,45	CHI
20201261555	FLORES DE GOIAS	FB12044974RE	IACIARA S2	11/12/2020 13:13	11/12/2020 13:54	11/12/2020 13:13	11/12/2020 13:54	0,68	6	4,10	CHI
20201261587	PIRENOPOLIS	PV21244365	CORUMBA	11/12/2020 13:20	11/12/2020 21:38	11/12/2020 13:20	11/12/2020 21:38	8,28	1	8,28	CHI
20201261592	TURVELANDIA	TD12384559	RIO DOS BOIS	11/12/2020 13:20	11/12/2020 22:14	11/12/2020 13:20	11/12/2020 22:14	8,90	4	35,59	CHI
20201261590	LUZIANIA	LZ12025119	RIO VERMELHO	11/12/2020 13:21	11/12/2020 17:08	11/12/2020 13:21	11/12/2020 17:08	3,78	23	87,00	CHI
20201261594	ANAPOLIS	AN21262511	ANAPOLIS UNIVERSITARIO S1	11/12/2020 13:21	11/12/2020 14:50	11/12/2020 13:21	11/12/2020 14:50	1,48	1	1,48	CHI
20201261595	SENADOR CANEDO	190093330	SENADOR CANEDO	11/12/2020 13:21	11/12/2020 15:30	11/12/2020 13:21	11/12/2020 15:30	2,14	1	2,14	CHI
20201261737	CRIXAS	CX12295212	SERRA DO OURO	11/12/2020 13:21	11/12/2020 15:44	11/12/2020 13:21	11/12/2020 15:44	2,37	28	66,49	CHI
20201261809	ORIZONA	OZ12114504	PIRES DO RIO S2	11/12/2020 13:22	11/12/2020 20:52	11/12/2020 13:22	11/12/2020 20:52	7,48	10	74,84	CHI
20201261612	BRAZABRANTES	10030117907	NEROPOLIS S1	11/12/2020 13:26	11/12/2020 21:10	11/12/2020 13:26	11/12/2020 21:10	7,73	0	0,00	CHI
20201261619	SILVANIA	SV21284547	VIANOPOLIS	11/12/2020 13:28	11/12/2020 16:47	11/12/2020 13:28	11/12/2020 16:47	3,31	1	3,31	CHI
20201261620	CALDAS NOVAS	CN21060243	CALDAS NOVAS S1	11/12/2020 13:28	11/12/2020 18:11	11/12/2020 13:28	11/12/2020 18:11	4,71	1	4,71	CHI
20201261635	EDEIA	EA21084059	EDEIA	11/12/2020 13:31	12/12/2020 01:26	11/12/2020 13:31	12/12/2020 01:26	11,90	2	23,80	CHI
20201262122	MARA ROSA	MQ12120038	MARA ROSA	11/12/2020 13:31	11/12/2020 19:43	11/12/2020 13:31	11/12/2020 19:43	6,19	2	12,38	CHI
20201261645	AMARALINA	LC12170975	MARA ROSA	11/12/2020 13:34	11/12/2020 15:31	11/12/2020 13:34	11/12/2020 15:31	1,94	11	21,38	CHI
20201261646	MINEIROS	MY21209752	PARQUE DAS EMAS	11/12/2020 13:34	11/12/2020 16:57	11/12/2020 13:34	11/12/2020 16:57	3,38	1	3,38	CHI
20201261647	TROMBAS	PO12297140RE	PORANGATU	11/12/2020 13:34	12/12/2020 02:42	11/12/2020 13:34	12/12/2020 02:42	13,13	169	2218,69	CHI
20201261647	PORANGATU	PO12297140RE	PORANGATU	11/12/2020 13:34	12/12/2020 02:42	11/12/2020 13:34	12/12/2020 02:42	13,13	5	65,64	CHI
20201261647	SANTA TEREZA DE GOIAS	PO12297140RE	PORANGATU	11/12/2020 13:34	12/12/2020 02:42	11/12/2020 13:34	12/12/2020 02:42	13,13	11	144,41	CHI
20201261647	PORANGATU	PO12297140RE	PORANGATU	11/12/2020 13:34	12/12/2020 02:42	11/12/2020 20:10	12/12/2020 02:42	6,52	11	71,71	CHI
20201264130	RIO VERDE	RV12246766	ACREUNA	11/12/2020 13:35	12/12/2020 10:52	11/12/2020 13:35	12/12/2020 10:52	21,28	2	42,56	CHI
20201261653	ITAPURANGA	10026965885	ITAPURANGA	11/12/2020 13:36	11/12/2020 16:43	11/12/2020 13:36	11/12/2020 16:43	3,12	1	3,12	CHI
20201261662	MONTIVIDIU DO NORTE	MX21139212	PORANGATU	11/12/2020 13:37	11/12/2020 17:23	11/12/2020 13:37	11/12/2020 17:23	3,76	1	3,76	CHI
20201261664	LEOPOLDO DE BULHOES	870026045	DAIA S2	11/12/2020 13:37	11/12/2020 22:05	11/12/2020 13:37	11/12/2020 22:05	8,47	1	8,47	CHI
20201261674	APARECIDA DE GOIANIA	11452122	INDEPENDENCIA S2	11/12/2020 13:39	11/12/2020 16:41	11/12/2020 13:39	11/12/2020 16:41	3,02	1	3,02	CHI
20201261676	FORMOSA	610122198	ITUIQUIRA	11/12/2020 13:40	11/12/2020 17:01	11/12/2020 13:40	11/12/2020 17:01	3,34	1	3,34	CHI

20201261688	FIRMINOPOLIS	FR21096978	FIRMINOPOLIS S1	11/12/2020 13:42	12/12/2020 10:25	11/12/2020 13:42	12/12/2020 10:25	20,71	1	20,71	CHI
20201261702	EDEIA	10020998307	EDEIA	11/12/2020 13:44	12/12/2020 03:30	11/12/2020 13:44	12/12/2020 03:30	13,76	1	13,76	CHI
20201261710	CRISTALINA	KR21431402	CRISTALINA S2	11/12/2020 13:45	11/12/2020 22:10	11/12/2020 13:45	11/12/2020 22:10	8,40	1	8,40	CHI
20201259203	RIO VERDE	630246506	CABRIUVA S2	11/12/2020 13:46	12/12/2020 18:36	11/12/2020 13:46	12/12/2020 18:36	28,84	1	28,84	CHI
20201261711	PLANALTINA	PI21218353	PLANALTINA	11/12/2020 13:46	11/12/2020 18:29	11/12/2020 13:46	11/12/2020 18:29	4,70	1	4,70	CHI
20201261716	TURVANIA	1220015481	FIRMINOPOLIS S2	11/12/2020 13:47	11/12/2020 19:27	11/12/2020 13:47	11/12/2020 19:27	5,66	1	5,66	CHI
20201261719	COLINAS DO SUL	TI12155523RE	MINACU	11/12/2020 13:48	12/12/2020 05:42	11/12/2020 13:48	12/12/2020 05:42	15,89	18	286,05	CHI
20201261720	APARECIDA DE GOIANIA	12431266	INDEPENDENCIA S2	11/12/2020 13:48	11/12/2020 16:16	11/12/2020 13:48	11/12/2020 16:16	2,45	1	2,45	CHI
20201261722	CRIXAS	NM12141217	RUBIATABA	11/12/2020 13:48	11/12/2020 17:49	11/12/2020 13:48	11/12/2020 17:49	4,00	2	8,00	CHI
20201261722	NOVA AMERICA	NM12141217	RUBIATABA	11/12/2020 13:48	11/12/2020 17:49	11/12/2020 13:48	11/12/2020 17:49	4,00	1	4,00	CHI
20201261985	ITAPURANGA	IK12186816	ITAPURANGA	11/12/2020 13:48	11/12/2020 21:51	11/12/2020 13:48	11/12/2020 21:51	8,04	6	48,21	CHI
20201261723	FORMOSA	610308063	ITUIQUIRA	11/12/2020 13:49	11/12/2020 15:28	11/12/2020 13:49	11/12/2020 15:28	1,64	1	1,64	CHI
20201262056	ORIZONA	OZ12084921RE	PIRES DO RIO S2	11/12/2020 13:49	11/12/2020 19:16	11/12/2020 13:49	11/12/2020 19:16	5,44	110	597,91	CHI
20201262056	VIANOPOLIS	OZ12084921RE	PIRES DO RIO S2	11/12/2020 13:49	11/12/2020 19:16	11/12/2020 13:49	11/12/2020 19:16	5,44	17	92,40	CHI
20201261725	CALDAS NOVAS	760373929	CALDAS NOVAS S2	11/12/2020 13:50	11/12/2020 20:54	11/12/2020 13:50	11/12/2020 20:54	7,07	1	7,07	CHI
20201261732	PORANGATU	TA12114216	NOVO PLANALTO	11/12/2020 13:51	11/12/2020 16:08	11/12/2020 13:51	11/12/2020 16:08	2,27	6	13,61	CHI
20201261733	PETROLINA DE GOIAS	PG21230691	PETROLINA	11/12/2020 13:52	11/12/2020 16:54	11/12/2020 13:52	11/12/2020 16:54	3,03	1	3,03	CHI
20201261735	PLANALTINA	PI12375541	PLANALTINA	11/12/2020 13:52	11/12/2020 15:36	11/12/2020 13:52	11/12/2020 15:36	1,73	186	321,68	CHI
20201261751	CRISTALINA	KR21163139	CRISTALINA S1	11/12/2020 13:56	11/12/2020 16:15	11/12/2020 13:56	11/12/2020 16:15	2,31	1	2,31	CHI
20201261752	GOIANIA	GN21387788	GOIANIA LESTE S2	11/12/2020 13:56	11/12/2020 15:31	11/12/2020 15:23	11/12/2020 15:31	0,13	2	0,27	CHI
20201261767	TRINDADE	40291066	GOYA S1	11/12/2020 13:59	11/12/2020 20:06	11/12/2020 13:59	11/12/2020 20:06	6,11	1	6,11	CHI
20201261801	ALTO PARAISO DE GOIAS	TI10398398	NIQUELANDIA SUBTRANSMISSAO	11/12/2020 14:00	11/12/2020 18:55	11/12/2020 14:00	11/12/2020 14:03	0,05	538	28,84	CHI
20201261801	ALTO PARAISO DE GOIAS	TI10398398	NIQUELANDIA SUBTRANSMISSAO	11/12/2020 14:00	11/12/2020 18:55	11/12/2020 14:00	11/12/2020 15:21	1,36	9	12,21	CHI
20201261801	CAVALCANTE	TI10398398	NIQUELANDIA SUBTRANSMISSAO	11/12/2020 14:00	11/12/2020 18:55	11/12/2020 14:00	11/12/2020 15:21	1,36	58	78,70	CHI
20201261801	COLINAS DO SUL	TI10398398	NIQUELANDIA SUBTRANSMISSAO	11/12/2020 14:00	11/12/2020 18:55	11/12/2020 14:00	11/12/2020 15:21	1,36	53	71,92	CHI
20201261801	COLINAS DO SUL	TI10398398	NIQUELANDIA SUBTRANSMISSAO	11/12/2020 14:00	11/12/2020 18:55	11/12/2020 14:02	11/12/2020 15:21	1,33	5	6,64	CHI
20201261801	ALTO PARAISO DE GOIAS	TI10398398	NIQUELANDIA SUBTRANSMISSAO	11/12/2020 14:00	11/12/2020 18:55	11/12/2020 14:00	11/12/2020 15:46	1,77	4	7,08	CHI
20201261801	COLINAS DO SUL	TI10398398	NIQUELANDIA SUBTRANSMISSAO	11/12/2020 14:00	11/12/2020 18:55	11/12/2020 14:00	11/12/2020 18:44	4,73	17	80,45	CHI
20201261801	NIQUELANDIA	TI10398398	NIQUELANDIA SUBTRANSMISSAO	11/12/2020 14:00	11/12/2020 18:55	11/12/2020 14:00	11/12/2020 18:44	4,73	4	18,93	CHI
20201261801	ALTO PARAISO DE GOIAS	TI10398398	NIQUELANDIA SUBTRANSMISSAO	11/12/2020 14:00	11/12/2020 18:55	11/12/2020 14:00	11/12/2020 18:44	4,73	13	61,52	CHI
20201261801	COLINAS DO SUL	BF10400725	NIQUELANDIA SUBTRANSMISSAO	11/12/2020 14:00	11/12/2020 18:55	11/12/2020 18:49	11/12/2020 18:55	0,10	17	1,76	CHI
20201261801	NIQUELANDIA	BF10400725	NIQUELANDIA SUBTRANSMISSAO	11/12/2020 14:00	11/12/2020 18:55	11/12/2020 18:49	11/12/2020 18:55	0,10	4	0,41	CHI
20201261801	ALTO PARAISO DE GOIAS	BF10400725	NIQUELANDIA SUBTRANSMISSAO	11/12/2020 14:00	11/12/2020 18:55	11/12/2020 18:49	11/12/2020 18:55	0,10	17	1,76	CHI
20201261822	ABADIANIA	AA12221425	ANAPOLIS UNIVERSITARIO S1	11/12/2020 14:00	11/12/2020 16:56	11/12/2020 14:00	11/12/2020 16:56	2,93	45	131,75	CHI
20201261822	GAMELEIRA DE GOIAS	AA12221425	ANAPOLIS UNIVERSITARIO S1	11/12/2020 14:00	11/12/2020 16:56	11/12/2020 14:00	11/12/2020 16:56	2,93	1	2,93	CHI
20201261777	AGUAS LINDAS DE GOIAS	4830268075	AGUAS LINDAS DE GOIAS S1	11/12/2020 14:01	11/12/2020 14:53	11/12/2020 14:01	11/12/2020 14:53	0,87	1	0,87	CHI
20201262084	SAO FRANCISCO DE GOIAS	SF12008967	SAO FRANCISCO DE GOIAS	11/12/2020 14:01	11/12/2020 18:23	11/12/2020 14:01	11/12/2020 18:23	4,36	18	78,41	CHI
20201261784	LZIANIA	LZ11084541	RIO VERMELHO	11/12/2020 14:02	11/12/2020 15:45	11/12/2020 14:02	11/12/2020 15:45	1,73	80	138,13	CHI
20201262177	CAMPINACU	UC12244555	PORANGATU	11/12/2020 14:02	11/12/2020 17:13	11/12/2020 14:02	11/12/2020 17:13	3,18	17	54,02	CHI
20201261790	CRISTALINA	KR12118520	PAMPLONA	11/12/2020 14:03	11/12/2020 16:07	11/12/2020 14:03	11/12/2020 16:07	2,06	2	4,13	CHI
20201263134	AMARALINA	LC12216163	MARA ROSA	11/12/2020 14:04	11/12/2020 21:08	11/12/2020 14:04	11/12/2020 21:08	7,06	5	35,29	CHI
20201261798	ANAPOLIS	20870620	ANAPOLIS UNIVERSITARIO S2	11/12/2020 14:05	11/12/2020 17:32	11/12/2020 14:05	11/12/2020 17:32	3,46	1	3,46	CHI
20201261805	TROMBAS	TB11364367	PORANGATU	11/12/2020 14:07	11/12/2020 15:53	11/12/2020 14:07	11/12/2020 15:53	1,77	1	1,77	CHI
20201261816	MINACU	IH21236247	MINACU	11/12/2020 14:09	11/12/2020 17:53	11/12/2020 14:09	11/12/2020 17:53	3,72	1	3,72	CHI
20201262355	QUIRINOPOLIS	QI32052465	SANTA HELENA S1	11/12/2020 14:09	11/12/2020 21:24	11/12/2020 14:09	11/12/2020 21:24	7,23	6	43,41	CHI
20201261825	APARECIDA DO RIO DOCE	JT21093824	CACHOEIRA ALTA	11/12/2020 14:11	11/12/2020 21:16	11/12/2020 14:11	11/12/2020 21:16	7,08	1	7,08	CHI
20201261826	GOIAS	GS12028005	GOIAS	11/12/2020 14:11	12/12/2020 16:11	11/12/2020 14:11	12/12/2020 16:11	26,00	4	103,98	CHI
20201261830	RIO VERDE	630395780	CABRIUVA S1	11/12/2020 14:11	11/12/2020 15:28	11/12/2020 14:11	11/12/2020 15:28	1,27	1	1,27	CHI
20201262247	GOIANIA	GN11291720	XAVANTES	11/12/2020 14:11	11/12/2020 18:16	11/12/2020 14:11	11/12/2020 18:16	4,07	26	105,77	CHI
20201267606	GOIAS	GS12028005	GOIAS	11/12/2020 14:11	12/12/2020 18:40	12/12/2020 18:33	12/12/2020 18:40	0,12	4	0,47	CHI
20201261834	APORE	AE12219493	ITAJA S1	11/12/2020 14:12	11/12/2020 19:50	11/12/2020 14:12	11/12/2020 19:50	5,63	3	16,89	CHI

20201261835	ANAPOLIS	20585263	ANAPOLIS UNIVERSITARIO S1	11/12/2020 14:12	11/12/2020 23:04	11/12/2020 14:12	11/12/2020 23:04	8,86	1	8,86	CHI
20201261837	CIDADE OCIDENTAL	2680130401	MARAJOARA	11/12/2020 14:12	11/12/2020 21:44	11/12/2020 14:12	11/12/2020 21:44	7,52	1	7,52	CHI
20201262342	VICENTINOPOLIS	VI12071025	VICENTINOPOLIS	11/12/2020 14:12	11/12/2020 17:40	11/12/2020 14:12	11/12/2020 16:40	2,46	413	1017,82	CHI
20201262342	VICENTINOPOLIS	VI12071025	VICENTINOPOLIS	11/12/2020 14:12	11/12/2020 17:40	11/12/2020 14:12	11/12/2020 17:40	3,46	143	495,38	CHI
20201261838	LUZIANIA	LZ21230117	PACAEMBU S2	11/12/2020 14:13	11/12/2020 20:41	11/12/2020 14:13	11/12/2020 20:41	6,47	2	12,93	CHI
20201261861	FLORES DE GOIAS	FB12320627	FLORES DE GOIAS	11/12/2020 14:13	11/12/2020 19:41	11/12/2020 14:13	11/12/2020 19:41	5,46	1	5,46	CHI
20201261861	FLORES DE GOIAS	FB12320627	FLORES DE GOIAS	11/12/2020 14:13	11/12/2020 19:41	11/12/2020 14:13	11/12/2020 19:41	5,47	27	147,69	CHI
20201261844	BALIZA	BH12358780	BOM JARDIM	11/12/2020 14:16	11/12/2020 15:39	11/12/2020 14:16	11/12/2020 15:39	1,39	15	20,82	CHI
20201261846	CAVALCANTE	TI12156216RE	MINACU	11/12/2020 14:16	12/12/2020 14:42	11/12/2020 14:16	12/12/2020 14:42	24,42	68	1660,77	CHI
20201261846	COLINAS DO SUL	TI12156216RE	MINACU	11/12/2020 14:16	12/12/2020 14:42	11/12/2020 14:16	12/12/2020 14:42	24,42	42	1025,77	CHI
20201261850	MINEIROS	MY21210406	PARQUE DAS EMAS	11/12/2020 14:16	12/12/2020 11:40	11/12/2020 14:16	12/12/2020 11:40	21,38	1	21,38	CHI
20201261853	POSSE	PS12302641	IACIARA S2	11/12/2020 14:18	11/12/2020 17:59	11/12/2020 14:18	11/12/2020 17:59	3,68	2	7,37	CHI
20201261855	ABADIANIA	350034539	ANAPOLIS UNIVERSITARIO S1	11/12/2020 14:18	11/12/2020 18:37	11/12/2020 14:18	11/12/2020 18:37	4,30	1	4,30	CHI
20201261899	PIRACANJUBA	PJ12013344	MORRINHOS	11/12/2020 14:18	12/12/2020 08:23	11/12/2020 14:18	12/12/2020 08:23	18,07	12	216,81	CHI
20201261869	ITABERAI	IB21336276	ITABERAI S1	11/12/2020 14:20	11/12/2020 16:01	11/12/2020 14:20	11/12/2020 16:01	1,67	1	1,67	CHI
20201261943	NIQUELANDIA	NQ12221620	URUACU	11/12/2020 14:21	11/12/2020 17:02	11/12/2020 14:21	11/12/2020 17:02	2,67	148	395,00	CHI
20201262198	SAO MIGUEL DO ARAGUAIA	SM12020625	SAO MIGUEL DO ARAGUAIA	11/12/2020 14:21	12/12/2020 04:57	11/12/2020 14:21	12/12/2020 04:57	14,59	6	87,52	CHI
20201261884	CIDADE OCIDENTAL	LZ21000293	MARAJOARA	11/12/2020 14:22	11/12/2020 15:40	11/12/2020 14:22	11/12/2020 15:40	1,29	1	1,29	CHI
20201261914	PETROLINA DE GOIAS	O3040214	INHUMAS S1	11/12/2020 14:22	11/12/2020 15:40	11/12/2020 14:22	11/12/2020 15:40	1,30	116	150,61	CHI
20201261914	SANTA ROSA DE GOIAS	O3040214	INHUMAS S1	11/12/2020 14:22	11/12/2020 15:40	11/12/2020 14:22	11/12/2020 15:40	1,30	414	537,51	CHI
20201261914	ITAUCU	O3040214	INHUMAS S1	11/12/2020 14:22	11/12/2020 15:40	11/12/2020 14:22	11/12/2020 15:40	1,30	6	7,79	CHI
20201261920	ORIZONA	OZ12079955	VIANOPOLIS	11/12/2020 14:23	11/12/2020 16:33	11/12/2020 14:23	11/12/2020 16:33	2,16	15	32,40	CHI
20201261920	VIANOPOLIS	OZ12079955	VIANOPOLIS	11/12/2020 14:23	11/12/2020 16:33	11/12/2020 14:23	11/12/2020 16:33	2,16	11	23,76	CHI
20201260341	FORMOSA	O2590206	ITUIQUIRA	11/12/2020 14:24	11/12/2020 18:15	11/12/2020 14:24	11/12/2020 18:15	3,84	492	1891,60	CHI
20201260341	VILA BOA	O2590206	ITUIQUIRA	11/12/2020 14:24	11/12/2020 18:15	11/12/2020 14:24	11/12/2020 18:15	3,84	6	23,07	CHI
20201260341	FLORES DE GOIAS	O2590206	ITUIQUIRA	11/12/2020 14:24	11/12/2020 18:15	11/12/2020 14:24	11/12/2020 18:15	3,84	2	7,69	CHI
20201260341	SAO JOAO D ALIANCA	O2590206	ITUIQUIRA	11/12/2020 14:24	11/12/2020 18:15	11/12/2020 14:24	11/12/2020 18:15	3,84	230	884,29	CHI
20201261908	JATAI	JT11377803	JATAI S2	11/12/2020 14:27	12/12/2020 08:59	11/12/2020 14:27	12/12/2020 08:59	18,53	1	18,53	CHI
20201262175	VILA PROPICIO	NP12339454	GOIANESIA S1	11/12/2020 14:28	12/12/2020 09:51	11/12/2020 14:28	12/12/2020 09:51	19,38	112	2170,40	CHI
20201262523	ORIZONA	OZ11140712	PIRES DO RIO S2	11/12/2020 14:29	11/12/2020 18:55	11/12/2020 14:29	11/12/2020 18:55	4,42	149	659,16	CHI
20201262561	ORIZONA	OZ12114547	PIRES DO RIO S2	11/12/2020 14:31	11/12/2020 20:52	11/12/2020 14:31	11/12/2020 20:52	6,35	8	50,80	CHI
20201261938	ITAPIRAPUA	IU12236488	JUSSARA	11/12/2020 14:32	11/12/2020 18:52	11/12/2020 14:32	11/12/2020 18:52	4,35	3	13,04	CHI
20201261939	QUIRINOPOLIS	QI21091033	QUIRINOPOLIS	11/12/2020 14:32	11/12/2020 21:18	11/12/2020 14:32	11/12/2020 21:18	6,76	1	6,76	CHI
20201262700	ITAJA	IM12303219	CACHOEIRA ALTA	11/12/2020 14:32	12/12/2020 09:01	11/12/2020 14:32	12/12/2020 09:01	18,48	5	92,40	CHI
20201262700	ITARUMA	IM12303219	CACHOEIRA ALTA	11/12/2020 14:32	12/12/2020 09:01	11/12/2020 14:32	12/12/2020 09:01	18,48	2	36,96	CHI
20201261950	QUIRINOPOLIS	QI21349466	QUIRINOPOLIS	11/12/2020 14:33	11/12/2020 16:45	11/12/2020 14:33	11/12/2020 16:45	2,18	1	2,18	CHI
20201261961	RIO VERDE	RV12000254	RIO VERDE S1	11/12/2020 14:36	11/12/2020 20:08	11/12/2020 14:36	11/12/2020 20:08	5,54	9	49,84	CHI
20201262065	URUTAI	UT12016978RE	URUTAI	11/12/2020 14:36	11/12/2020 17:03	11/12/2020 14:36	11/12/2020 17:03	2,45	111	271,73	CHI
20201261962	CORUMBAIBA	CI11057440	VILA CORUMBA	11/12/2020 14:37	11/12/2020 19:16	11/12/2020 14:37	11/12/2020 19:16	4,65	25	116,24	CHI
20201261965	APARECIDA DE GOIANIA	10007283278	INDEPENDENCIA S2	11/12/2020 14:37	11/12/2020 16:36	11/12/2020 14:37	11/12/2020 16:36	1,97	1	1,97	CHI
20201262108	POSSE	PS12132045	IACIARA S2	11/12/2020 14:38	11/12/2020 16:16	11/12/2020 14:38	11/12/2020 16:16	1,62	202	328,19	CHI
20201262689	NIQUELANDIA	NQ21253830	URUACU	11/12/2020 14:38	11/12/2020 22:30	11/12/2020 14:38	11/12/2020 22:30	7,86	1	7,86	CHI
20201261981	GOIANIA	GN12111420	REAL S2	11/12/2020 14:39	11/12/2020 16:19	11/12/2020 14:39	11/12/2020 16:19	1,65	134	221,36	CHI
20201261986	ORIZONA	O1480414	PIRES DO RIO S2	11/12/2020 14:39	11/12/2020 23:44	11/12/2020 14:39	11/12/2020 15:18	0,66	9	5,93	CHI
20201261986	URUTAI	O1480414	PIRES DO RIO S2	11/12/2020 14:39	11/12/2020 23:44	11/12/2020 14:39	11/12/2020 15:18	0,66	103	67,92	CHI
20201261986	IPAMERI	O1480414	PIRES DO RIO S2	11/12/2020 14:39	11/12/2020 23:44	11/12/2020 14:39	11/12/2020 15:18	0,66	94	61,99	CHI
20201261986	PIRES DO RIO	O1480414	PIRES DO RIO S2	11/12/2020 14:39	11/12/2020 23:44	11/12/2020 14:39	11/12/2020 15:18	0,66	10	6,59	CHI
20201261986	URUTAI	O1480414	PIRES DO RIO S2	11/12/2020 14:39	11/12/2020 23:44	11/12/2020 15:28	11/12/2020 15:57	0,49	104	51,13	CHI
20201261986	PIRES DO RIO	O1480414	PIRES DO RIO S2	11/12/2020 14:39	11/12/2020 23:44	11/12/2020 15:28	11/12/2020 15:57	0,49	10	4,92	CHI
20201261986	ORIZONA	O1480414	PIRES DO RIO S2	11/12/2020 14:39	11/12/2020 23:44	11/12/2020 15:28	11/12/2020 15:57	0,49	9	4,43	CHI
20201261986	IPAMERI	O1480414	PIRES DO RIO S2	11/12/2020 14:39	11/12/2020 23:44	11/12/2020 15:28	11/12/2020 15:57	0,49	94	46,22	CHI

20201261986	URUTAI	01480414	PIRES DO RIO S2	11/12/2020 14:39	11/12/2020 23:44	11/12/2020 16:00	11/12/2020 17:06	1,10	104	114,14	CHI
20201261986	PIRES DO RIO	01480414	PIRES DO RIO S2	11/12/2020 14:39	11/12/2020 23:44	11/12/2020 16:00	11/12/2020 17:06	1,10	10	10,98	CHI
20201261986	ORIZONA	01480414	PIRES DO RIO S2	11/12/2020 14:39	11/12/2020 23:44	11/12/2020 16:00	11/12/2020 17:06	1,10	9	9,88	CHI
20201261986	IPAMERI	01480414	PIRES DO RIO S2	11/12/2020 14:39	11/12/2020 23:44	11/12/2020 16:00	11/12/2020 17:06	1,10	94	103,17	CHI
20201261986	ORIZONA	01480414	PIRES DO RIO S2	11/12/2020 14:39	11/12/2020 23:44	11/12/2020 17:21	11/12/2020 18:24	1,05	8	8,41	CHI
20201261986	PIRES DO RIO	01480414	PIRES DO RIO S2	11/12/2020 14:39	11/12/2020 23:44	11/12/2020 17:21	11/12/2020 18:24	1,05	10	10,51	CHI
20201261986	URUTAI	01480414	PIRES DO RIO S2	11/12/2020 14:39	11/12/2020 23:44	11/12/2020 17:21	11/12/2020 18:24	1,05	98	102,98	CHI
20201261986	IPAMERI	IP13186518	PIRES DO RIO S2	11/12/2020 14:39	11/12/2020 23:44	11/12/2020 17:21	11/12/2020 20:39	3,31	84	277,74	CHI
20201261986	URUTAI	UT13216020	PIRES DO RIO S2	11/12/2020 14:39	11/12/2020 23:44	11/12/2020 17:21	11/12/2020 23:44	6,38	6	38,28	CHI
20201261986	IPAMERI	UT13216020	PIRES DO RIO S2	11/12/2020 14:39	11/12/2020 23:44	11/12/2020 17:21	11/12/2020 23:44	6,38	10	63,80	CHI
20201261986	ORIZONA	UT13216020	PIRES DO RIO S2	11/12/2020 14:39	11/12/2020 23:44	11/12/2020 17:21	11/12/2020 23:44	6,38	1	6,38	CHI
20201261989	SAO JOAO D ALIANCA	JL12383335	SAO JOAO D ALIANCA	11/12/2020 14:39	11/12/2020 17:39	11/12/2020 14:39	11/12/2020 17:39	2,99	11	32,90	CHI
20201262088	MINEIROS	MY12377570	PARQUE DAS EMAS	11/12/2020 14:41	11/12/2020 16:30	11/12/2020 14:41	11/12/2020 16:30	1,81	105	190,40	CHI
20201261999	PORANGATU	PO12000010	PORANGATU	11/12/2020 14:43	11/12/2020 16:35	11/12/2020 14:43	11/12/2020 16:35	1,86	5	9,28	CHI
20201262005	PORANGATU	PO12252122	PORANGATU	11/12/2020 14:44	11/12/2020 15:43	11/12/2020 14:44	11/12/2020 15:43	0,97	18	17,44	CHI
20201262054	NEROPOLIS	NR12000048	NEROPOLIS S2	11/12/2020 14:45	12/12/2020 19:02	11/12/2020 14:45	11/12/2020 19:40	4,91	8	39,26	CHI
20201262054	NEROPOLIS	NR12000048	NEROPOLIS S2	11/12/2020 14:45	12/12/2020 19:02	12/12/2020 13:40	12/12/2020 14:20	0,67	8	5,33	CHI
20201262054	NEROPOLIS	NR12000048	NEROPOLIS S2	11/12/2020 14:45	12/12/2020 19:02	11/12/2020 14:45	12/12/2020 19:02	28,27	8	226,19	CHI
20201262070	NAZARIO	NZ12003900	ANICUNS	11/12/2020 14:45	11/12/2020 16:18	11/12/2020 14:45	11/12/2020 16:18	1,54	12	18,48	CHI
20201262357	PIRACANJUBA	PJ12082694	PIRACANJUBA	11/12/2020 14:46	11/12/2020 22:28	11/12/2020 14:46	11/12/2020 22:28	7,69	6	46,14	CHI
20201262023	BARRO ALTO	1150025041	BARRO ALTO	11/12/2020 14:47	12/12/2020 21:34	11/12/2020 14:47	12/12/2020 21:34	30,77	1	30,77	CHI
20201262027	PIRENOPOLIS	AN21325301	ANAPOLIS UNIVERSITARIO S2	11/12/2020 14:48	11/12/2020 22:03	11/12/2020 14:48	11/12/2020 22:03	7,24	1	7,24	CHI
20201262030	LEOPOLDO DE BULHOES	LB21334094	CEPAIGO S2	11/12/2020 14:49	11/12/2020 21:10	11/12/2020 14:49	11/12/2020 21:10	6,35	5	31,74	CHI
20201262031	LUZIANIA	LZ11370735	RIO VERMELHO	11/12/2020 14:49	11/12/2020 19:36	11/12/2020 14:49	11/12/2020 19:36	4,78	16	76,48	CHI
20201262034	NIQUELANDIA	NQ12264219	BARRO ALTO	11/12/2020 14:49	11/12/2020 20:35	11/12/2020 14:49	11/12/2020 20:35	5,75	1	5,75	CHI
20201262308	AGUA FRIA DE GOIAS	TL12048061	SAO JOAO D ALIANCA	11/12/2020 14:49	11/12/2020 21:39	11/12/2020 14:49	11/12/2020 21:39	6,82	56	381,98	CHI
20201262045	SANTA TEREZINHA DE GOIAS	SG12320672	SANTA TEREZINHA	11/12/2020 14:51	11/12/2020 20:34	11/12/2020 14:51	11/12/2020 20:34	5,71	6	34,24	CHI
20201262207	ESTRELA DO NORTE	ET18050738FS	MARA ROSA	11/12/2020 14:51	11/12/2020 18:01	11/12/2020 14:51	11/12/2020 18:01	3,16	12	37,89	CHI
20201262207	MARA ROSA	ET18050738FS	MARA ROSA	11/12/2020 14:51	11/12/2020 18:01	11/12/2020 14:51	11/12/2020 18:01	3,16	64	202,10	CHI
20201262207	FORMOSO	ET18050738FS	MARA ROSA	11/12/2020 14:51	11/12/2020 18:01	11/12/2020 14:51	11/12/2020 18:01	3,16	74	233,68	CHI
20201262049	GUARANI DE GOIAS	GY21142694	IACIARA S1	11/12/2020 14:52	11/12/2020 21:15	11/12/2020 14:52	11/12/2020 21:15	6,38	2	12,75	CHI
20201262053	JATAI	290142969	JATAI S3	11/12/2020 14:52	12/12/2020 10:55	11/12/2020 14:52	12/12/2020 10:55	20,04	1	20,04	CHI
20201262057	INDIARA	IY12233349	CEZARINA	11/12/2020 14:53	11/12/2020 19:22	11/12/2020 14:53	11/12/2020 19:22	4,47	6	26,84	CHI
20201262498	MONTES CLAROS DE GOIAS	ME12140008	IPORA	11/12/2020 14:54	12/12/2020 10:07	11/12/2020 14:54	12/12/2020 10:07	19,22	18	345,89	CHI
20201262155	CIDADE OCIDENTAL	DH12356099	MARAJOARA	11/12/2020 14:56	11/12/2020 16:30	11/12/2020 14:56	11/12/2020 16:30	1,56	29	45,10	CHI
20201262078	TURVANIA	TV12259071	FIRMINOPOLIS S2	11/12/2020 14:57	12/12/2020 11:58	11/12/2020 14:57	12/12/2020 11:58	21,00	5	105,01	CHI
20201262174	ANAPOLIS	AN12258782	ANAPOLIS UNIVERSITARIO S2	11/12/2020 14:57	12/12/2020 22:07	11/12/2020 14:57	12/12/2020 11:05	20,13	19	382,54	CHI
20201262174	ANAPOLIS	AN12258782	ANAPOLIS UNIVERSITARIO S2	11/12/2020 14:57	12/12/2020 22:07	12/12/2020 11:07	12/12/2020 11:45	0,64	11	7,00	CHI
20201262174	ANAPOLIS	AN21283874	ANAPOLIS UNIVERSITARIO S2	11/12/2020 14:57	12/12/2020 22:07	12/12/2020 11:07	12/12/2020 18:41	7,55	1	7,55	CHI
20201262174	ANAPOLIS	AN21258550	ANAPOLIS UNIVERSITARIO S2	11/12/2020 14:57	12/12/2020 22:07	12/12/2020 11:07	12/12/2020 19:02	7,91	2	15,81	CHI
20201262174	ANAPOLIS	AN21059012	ANAPOLIS UNIVERSITARIO S2	11/12/2020 14:57	12/12/2020 22:07	12/12/2020 11:07	12/12/2020 19:34	8,44	4	33,78	CHI
20201262174	ANAPOLIS	AN12258782	ANAPOLIS UNIVERSITARIO S2	11/12/2020 14:57	12/12/2020 22:07	12/12/2020 11:07	12/12/2020 21:16	10,14	1	10,14	CHI
20201262174	ANAPOLIS	AN12258782	ANAPOLIS UNIVERSITARIO S2	11/12/2020 14:57	12/12/2020 22:07	12/12/2020 20:19	12/12/2020 21:16	0,96	14	13,38	CHI
20201262174	ANAPOLIS	AN21059012	ANAPOLIS UNIVERSITARIO S2	11/12/2020 14:57	12/12/2020 22:07	12/12/2020 20:19	12/12/2020 22:07	1,81	4	7,25	CHI
20201263693	FORMOSA	FA12204709	ITIQUEIRA	11/12/2020 14:58	12/12/2020 12:00	11/12/2020 14:58	12/12/2020 12:00	21,02	5	105,10	CHI
20201262095	OUVIDOR	2180014771	CATALAO S1	11/12/2020 15:01	11/12/2020 16:39	11/12/2020 15:01	11/12/2020 16:39	1,63	1	1,63	CHI
20201262532	CRISTALINA	KR12133541LD	CRISTALINA S1	11/12/2020 15:01	11/12/2020 19:49	11/12/2020 15:01	11/12/2020 19:49	4,79	14	67,09	CHI
20201262378	OURO VERDE DE GOIAS	OV12215905	NEROPOLIS S2	11/12/2020 15:02	11/12/2020 22:55	11/12/2020 15:02	11/12/2020 22:55	7,87	10	78,74	CHI
20201262110	FORMOSA	FA11051114	ITIQUEIRA	11/12/2020 15:03	12/12/2020 12:18	11/12/2020 15:03	12/12/2020 12:18	21,24	2	42,49	CHI
20201262116	RIO VERDE	MV12303520	MONTIVIDIU T	11/12/2020 15:05	12/12/2020 01:07	11/12/2020 15:05	12/12/2020 01:07	10,03	1	10,03	CHI
20201262116	MONTIVIDIU	MV12303520	MONTIVIDIU T	11/12/2020 15:05	12/12/2020 01:07	11/12/2020 15:05	12/12/2020 01:07	10,03	3	30,08	CHI

20201262119	UIRAPURU	UP21257305	SANTA TEREZINHA	11/12/2020 15:05	12/12/2020 07:32	11/12/2020 15:05	12/12/2020 07:32	16,44	1	16,44	CHI
20201262120	SILVANIA	SV11247218	VIANOPOLIS	11/12/2020 15:06	11/12/2020 19:12	11/12/2020 15:06	11/12/2020 19:12	4,09	1	4,09	CHI
20201262121	RIO VERDE	10019387618	RIO VERDE S2	11/12/2020 15:06	11/12/2020 17:11	11/12/2020 15:06	11/12/2020 17:11	2,07	1	2,07	CHI
20201262128	GOIANIA	10013855954	FERROVIARIO S2	11/12/2020 15:07	11/12/2020 17:30	11/12/2020 15:07	11/12/2020 17:30	2,38	1	2,38	CHI
20201262136	CACHOEIRA ALTA	CA21075277	CACHOEIRA ALTA	11/12/2020 15:09	11/12/2020 20:44	11/12/2020 15:09	11/12/2020 20:44	5,58	2	11,17	CHI
20201262140	JARAGUA	JA21227851	JARAGUA	11/12/2020 15:09	12/12/2020 15:05	11/12/2020 15:09	12/12/2020 15:05	23,93	2	47,85	CHI
20201262149	CAMPINACU	UC11269602	MARA ROSA	11/12/2020 15:10	11/12/2020 18:59	11/12/2020 15:10	11/12/2020 18:59	3,80	1	3,80	CHI
20201262150	CAIAPONIA	CP12184232	MONTIVIDIU T	11/12/2020 15:11	12/12/2020 08:20	11/12/2020 15:11	12/12/2020 08:20	17,15	1	17,15	CHI
20201262159	JUSSARA	JR12008743	BRITANIA	11/12/2020 15:12	11/12/2020 17:35	11/12/2020 15:12	11/12/2020 17:35	2,37	38	90,12	CHI
20201262160	SERRANOPOLIS	SX12254103	CHAPADAO DO CEU	11/12/2020 15:12	12/12/2020 09:42	11/12/2020 15:12	12/12/2020 09:42	18,49	9	166,40	CHI
20201262164	RIO VERDE	630521098	RIO VERDE S2	11/12/2020 15:13	11/12/2020 23:13	11/12/2020 15:13	11/12/2020 23:13	7,99	1	7,99	CHI
20201262173	LUZIANIA	120312580	RIO VERMELHO	11/12/2020 15:14	11/12/2020 16:48	11/12/2020 15:14	11/12/2020 16:48	1,55	1	1,55	CHI
20201262180	SANTA HELENA DE GOIAS	400081910	IPEGUARI	11/12/2020 15:16	12/12/2020 01:09	11/12/2020 15:16	12/12/2020 01:09	9,88	1	9,88	CHI
20201262184	ITUMBIARA	BG12000055	ITUMBIARA VELHA S2	11/12/2020 15:17	11/12/2020 23:33	11/12/2020 15:17	11/12/2020 23:33	8,25	1	8,25	CHI
20201262186	GOIANIA	10305646	CAMPINAS S2	11/12/2020 15:18	11/12/2020 19:10	11/12/2020 15:18	11/12/2020 19:10	3,86	1	3,86	CHI
20201262187	CAVALCANTE	MA12405108	SAO DOMINGOS	11/12/2020 15:18	11/12/2020 22:00	11/12/2020 18:41	11/12/2020 22:00	3,31	245	812,11	CHI
20201262187	MONTE ALEGRE DE GOIAS	MA12405108	SAO DOMINGOS	11/12/2020 15:18	11/12/2020 22:00	11/12/2020 18:41	11/12/2020 22:00	3,31	530	1756,80	CHI
20201262187	NOVA ROMA	MA12405108	SAO DOMINGOS	11/12/2020 15:18	11/12/2020 22:00	11/12/2020 18:41	11/12/2020 22:00	3,31	57	188,94	CHI
20201262188	GOIANIA	10027402280	ATLANTICO S1	11/12/2020 15:18	11/12/2020 16:20	11/12/2020 15:18	11/12/2020 16:20	1,03	1	1,03	CHI
20201262375	CRIXAS	CX12318471	SERRA DO OURO	11/12/2020 15:18	11/12/2020 18:27	11/12/2020 15:18	11/12/2020 18:27	3,13	12	37,62	CHI
202012117176	MONTE ALEGRE DE GOIAS	MA21356692	SAO DOMINGOS	11/12/2020 15:18	11/12/2020 22:00	11/12/2020 15:18	11/12/2020 22:00	6,69	1	6,69	CHI
20201262193	VILA PROPICIO	NP12402058	GOIANESIA S1	11/12/2020 15:19	11/12/2020 20:20	11/12/2020 15:19	11/12/2020 20:20	5,01	95	476,37	CHI
20201262193	COCALZINHO DE GOIAS	NP12402058	GOIANESIA S1	11/12/2020 15:19	11/12/2020 20:20	11/12/2020 15:19	11/12/2020 20:20	5,01	1	5,01	CHI
20201262193	PADRE BERNARDO	NP12402058	GOIANESIA S1	11/12/2020 15:19	11/12/2020 20:20	11/12/2020 15:19	11/12/2020 20:20	5,01	11	55,16	CHI
20201262200	SILVANIA	SV21157830	VIANOPOLIS	11/12/2020 15:20	11/12/2020 19:05	11/12/2020 15:20	11/12/2020 19:05	3,73	1	3,73	CHI
20201262834	FORMOSA	FA12146111	ITUIQUIRA	11/12/2020 15:20	12/12/2020 10:01	11/12/2020 15:20	12/12/2020 10:01	18,68	11	205,46	CHI
20201262203	URUACU	UR12325185	URUACU	11/12/2020 15:21	11/12/2020 21:15	11/12/2020 15:21	11/12/2020 21:15	5,90	22	129,89	CHI
20201262203	PILAR DE GOIAS	UR12325185	URUACU	11/12/2020 15:21	11/12/2020 21:15	11/12/2020 15:21	11/12/2020 21:15	5,90	1	5,90	CHI
20201262209	GOIAS	GS11162333	GOIAS	11/12/2020 15:21	12/12/2020 08:43	11/12/2020 15:21	12/12/2020 08:43	17,35	2	34,70	CHI
20201262790	PIRACANJUBA	PJ12212205	PIRACANJUBA	11/12/2020 15:21	11/12/2020 21:56	11/12/2020 15:21	11/12/2020 21:56	6,57	22	144,53	CHI
20201262258	GOIANIA	GN10380025	FERROVIARIO S1	11/12/2020 15:23	11/12/2020 17:32	11/12/2020 15:23	11/12/2020 15:27	0,07	858	59,11	CHI
20201262258	GOIANIA	GN16426132	FERROVIARIO S1	11/12/2020 15:23	11/12/2020 17:32	11/12/2020 15:23	11/12/2020 16:29	1,09	336	366,99	CHI
20201262258	GOIANIA	GN16426132	FERROVIARIO S1	11/12/2020 15:23	11/12/2020 17:32	11/12/2020 15:23	11/12/2020 16:44	1,35	297	399,55	CHI
20201262258	GOIANIA	GN16426132	FERROVIARIO S1	11/12/2020 15:23	11/12/2020 17:32	11/12/2020 15:23	11/12/2020 17:32	2,15	257	553,55	CHI
20201262221	PLANALTINA	PI21125112	SAO JOAO D ALIANCA	11/12/2020 15:24	11/12/2020 20:39	11/12/2020 15:24	11/12/2020 20:39	5,24	2	10,48	CHI
20201262224	SANTA HELENA DE GOIAS	400009353	IPEGUARI	11/12/2020 15:25	11/12/2020 16:26	11/12/2020 15:25	11/12/2020 16:26	1,01	1	1,01	CHI
20201262227	LUZIANIA	LZ21031997	RIO VERMELHO	11/12/2020 15:25	11/12/2020 19:30	11/12/2020 15:25	11/12/2020 19:30	4,07	1	4,07	CHI
20201262313	ANAPOLIS	AN12258125	ANAPOLIS UNIVERSITARIO S2	11/12/2020 15:26	11/12/2020 17:11	11/12/2020 15:26	11/12/2020 17:11	1,74	372	647,90	CHI
20201262371	IVOLANDIA	IV12390185	IPORA	11/12/2020 15:26	11/12/2020 19:38	11/12/2020 15:26	11/12/2020 19:38	4,19	13	54,48	CHI
20201262235	SANCLERLANDIA	SC21032587	FIRMINOPOLIS S2	11/12/2020 15:27	11/12/2020 18:40	11/12/2020 15:27	11/12/2020 18:40	3,22	1	3,22	CHI
20201262237	NIQUELANDIA	NQ12228246	NIQUELANDIA SUBTRANSMISSAO	11/12/2020 15:27	11/12/2020 19:17	11/12/2020 15:27	11/12/2020 19:17	3,83	2	7,66	CHI
20201262242	ITABERAI	IB12359511	ITABERAI S1	11/12/2020 15:27	11/12/2020 17:07	11/12/2020 15:27	11/12/2020 17:07	1,66	3	4,97	CHI
20201262335	ESTRELA DO NORTE	MU12075219	MARA ROSA	11/12/2020 15:27	11/12/2020 18:18	11/12/2020 15:27	11/12/2020 18:18	2,85	1	2,85	CHI
20201262335	MUTUNOPOLIS	MU12075219	MARA ROSA	11/12/2020 15:27	11/12/2020 18:18	11/12/2020 15:27	11/12/2020 18:18	2,85	8	22,77	CHI
20201262244	MINACU	IH21314261	MINACU	11/12/2020 15:28	11/12/2020 15:56	11/12/2020 15:28	11/12/2020 15:56	0,46	2	0,93	CHI
20201262266	PARAUNA	PU12228071	PARAUNA	11/12/2020 15:31	11/12/2020 16:17	11/12/2020 15:31	11/12/2020 16:17	0,76	5	3,81	CHI
20201262644	ITARUMA	IM12107399	CACHOEIRA ALTA	11/12/2020 15:31	12/12/2020 03:24	11/12/2020 15:31	12/12/2020 03:24	11,88	4	47,53	CHI
20201262270	MINACU	IH21220754	MINACU	11/12/2020 15:32	12/12/2020 00:01	11/12/2020 15:32	12/12/2020 00:01	8,47	1	8,47	CHI
20201262273	ITAPURANGA	170057653	ITAPURANGA	11/12/2020 15:33	12/12/2020 12:50	11/12/2020 15:33	12/12/2020 12:50	21,28	1	21,28	CHI
20201262274	NOVA AURORA	2220008156	CATALAO S1	11/12/2020 15:33	11/12/2020 18:35	11/12/2020 15:33	11/12/2020 18:35	3,02	1	3,02	CHI
20201262276	RIO VERDE	RV12271690	MONTIVIDIU T	11/12/2020 15:34	11/12/2020 18:46	11/12/2020 15:34	11/12/2020 18:46	3,20	1	3,20	CHI

20201262280	RIO VERDE	RV21331622	SANTA HELENA S1	11/12/2020 15:34	11/12/2020 22:30	11/12/2020 15:34	11/12/2020 22:30	6,92	1	6,92	CHI
20201262283	GUAPO	710026225	GUAPO S1	11/12/2020 15:34	11/12/2020 19:27	11/12/2020 15:34	11/12/2020 19:27	3,87	1	3,87	CHI
20201262288	NOVO GAMA	LZ12000471	PACAEMBU S2	11/12/2020 15:35	11/12/2020 20:07	11/12/2020 15:35	11/12/2020 20:07	4,53	3	13,58	CHI
20201262291	GUAPO	GA21000025	GUAPO S1	11/12/2020 15:36	11/12/2020 22:50	11/12/2020 15:36	11/12/2020 22:50	7,23	1	7,23	CHI
20201262292	RIO VERDE	RV21191768	MONTIVIDIU T	11/12/2020 15:36	11/12/2020 22:13	11/12/2020 15:36	11/12/2020 22:13	6,62	1	6,62	CHI
20201262295	MUTUNOPOLIS	MU21086714	MARA ROSA	11/12/2020 15:36	11/12/2020 16:02	11/12/2020 15:36	11/12/2020 16:02	0,43	1	0,43	CHI
20201262299	CIDADE OCIDENTAL	DH12136565	MARAJOARA	11/12/2020 15:37	11/12/2020 22:58	11/12/2020 15:37	11/12/2020 22:58	7,34	5	36,70	CHI
20201262304	BALIZA	BH11331305	CAIAPONIA	11/12/2020 15:38	11/12/2020 23:25	11/12/2020 15:38	11/12/2020 23:25	7,77	1	7,77	CHI
20201262307	MINACU	4020024328	MINACU	11/12/2020 15:38	12/12/2020 02:42	11/12/2020 15:38	12/12/2020 02:42	11,06	1	11,06	CHI
20201262309	INHUMAS	IN21132777	ARACU	11/12/2020 15:38	12/12/2020 00:02	11/12/2020 15:38	12/12/2020 00:02	8,38	1	8,38	CHI
20201262311	TRINDADE	TR12000053	TRINDADE	11/12/2020 15:39	11/12/2020 22:09	11/12/2020 15:39	11/12/2020 22:09	6,50	3	19,49	CHI
20201262333	GOIANIA	10019648993	CARAJAS S1	11/12/2020 15:39	11/12/2020 16:56	11/12/2020 15:39	11/12/2020 16:56	1,27	0	0,00	CHI
20201262513	ORIZONA	OZ12043232RE	PIRES DO RIO S2	11/12/2020 15:40	11/12/2020 20:07	11/12/2020 15:40	11/12/2020 20:07	4,43	51	226,14	CHI
20201262918	POSSE	PS12302648	IACIARA S2	11/12/2020 15:40	11/12/2020 18:31	11/12/2020 15:40	11/12/2020 18:31	2,85	4	11,38	CHI
20201262320	SANTA CRUZ DE GOIAS	PJ12212206	CALDAS NOVAS S1	11/12/2020 15:41	12/12/2020 11:26	11/12/2020 15:41	12/12/2020 11:26	19,75	1	19,75	CHI
20201262326	NEROPOLIS	10030401966	NEROPOLIS S2	11/12/2020 15:41	11/12/2020 21:27	11/12/2020 15:41	11/12/2020 21:27	5,76	1	5,76	CHI
20201262327	GOIANIA	GN12035847	GOIANIA LESTE S1	11/12/2020 15:42	11/12/2020 18:25	11/12/2020 15:42	11/12/2020 17:06	1,40	83	116,18	CHI
20201262327	GOIANIA	GN11188893	GOIANIA LESTE S1	11/12/2020 15:42	11/12/2020 18:25	11/12/2020 15:42	11/12/2020 18:25	2,71	50	135,56	CHI
20201262337	GOIANIA	GN11216848	ATLANTICO S1	11/12/2020 15:45	11/12/2020 17:46	11/12/2020 15:45	11/12/2020 17:46	2,02	42	84,65	CHI
20201262340	FORMOSA	610223409	ITUIQUIRA	11/12/2020 15:45	11/12/2020 19:25	11/12/2020 15:45	11/12/2020 19:25	3,66	1	3,66	CHI
20201262503	COCALZINHO DE GOIAS	PB12382216	PADRE BERNARDO	11/12/2020 15:45	11/12/2020 17:22	11/12/2020 15:45	11/12/2020 17:22	1,60	1	1,60	CHI
20201262503	PADRE BERNARDO	PB12382216	PADRE BERNARDO	11/12/2020 15:45	11/12/2020 17:22	11/12/2020 15:45	11/12/2020 17:22	1,60	6	9,62	CHI
20201262937	PIRENOPOLIS	PV12227987	CORUMBA	11/12/2020 15:45	11/12/2020 22:00	11/12/2020 15:45	11/12/2020 22:00	6,25	6	37,50	CHI
20201263998	SILVANIA	SV12400022	VIANOPOLIS	11/12/2020 15:45	11/12/2020 22:50	11/12/2020 15:45	11/12/2020 22:50	7,08	28	198,15	CHI
20201262341	SENADOR CANEDO	16061901	SENADOR CANEDO	11/12/2020 15:46	11/12/2020 16:52	11/12/2020 15:46	11/12/2020 16:52	1,10	1	1,10	CHI
20201262344	MINEIROS	MY21303918	PARQUE DAS EMAS	11/12/2020 15:46	12/12/2020 00:40	11/12/2020 15:46	12/12/2020 00:40	8,89	1	8,89	CHI
20201262346	JATAI	290066736	JATAI S3	11/12/2020 15:47	12/12/2020 08:48	11/12/2020 15:47	12/12/2020 08:48	17,01	1	17,01	CHI
20201262348	GOIANIA	10004381392	ATLANTICO S1	11/12/2020 15:48	11/12/2020 16:55	11/12/2020 15:48	11/12/2020 16:55	1,11	1	1,11	CHI
20201262369	MORRINHOS	MR32060369	MORRINHOS	11/12/2020 15:48	11/12/2020 21:07	11/12/2020 15:48	11/12/2020 21:07	5,31	23	122,03	CHI
20201263498	NOVA CRIXAS	NA11320889	NOVA CRIXAS	11/12/2020 15:48	12/12/2020 01:55	11/12/2020 15:48	12/12/2020 01:55	10,11	139	1404,71	CHI
20201262356	GOIANIA	AP12008304	CEPAIGO S1	11/12/2020 15:49	11/12/2020 18:15	11/12/2020 15:49	11/12/2020 18:15	2,43	60	145,88	CHI
20201262356	SENADOR CANEDO	AP12008304	CEPAIGO S1	11/12/2020 15:49	11/12/2020 18:15	11/12/2020 15:49	11/12/2020 18:15	2,43	426	1035,77	CHI
20201262360	JATAI	JT21172273	JATAI S1	11/12/2020 15:49	11/12/2020 17:55	11/12/2020 15:49	11/12/2020 17:55	2,09	1	2,09	CHI
20201262394	GOIANIA	GN11039764	FERROVIARIO S3	11/12/2020 15:49	11/12/2020 20:22	11/12/2020 15:49	11/12/2020 20:22	4,54	32	145,23	CHI
20201262710	CABECEIRAS	CW12398925	ITUIQUIRA	11/12/2020 15:49	11/12/2020 19:06	11/12/2020 15:49	11/12/2020 19:06	3,27	28	91,54	CHI
20201262368	CRISTALINA	KR12348546RE	PAMPLONA	11/12/2020 15:50	11/12/2020 20:02	11/12/2020 15:50	11/12/2020 20:02	4,19	22	92,24	CHI
20201262381	PORANGATU	PO12104373	PORANGATU	11/12/2020 15:52	11/12/2020 15:59	11/12/2020 15:52	11/12/2020 15:59	0,11	32	3,66	CHI
20201262712	PADRE BERNARDO	PB12163217	PADRE BERNARDO	11/12/2020 15:52	11/12/2020 18:05	11/12/2020 15:52	11/12/2020 18:05	2,22	120	266,03	CHI
20201262387	APARECIDA DE GOIANIA	AP11168024	ANHANGUERA	11/12/2020 15:54	11/12/2020 22:52	11/12/2020 15:54	11/12/2020 22:52	6,97	54	376,18	CHI
20201262395	GOIANIA	GN11291453	AEROPORTO S1	11/12/2020 15:54	12/12/2020 01:22	11/12/2020 15:54	11/12/2020 19:05	3,17	83	263,18	CHI
20201262395	GOIANIA	GN12001859	AEROPORTO S1	11/12/2020 15:54	12/12/2020 01:22	11/12/2020 19:03	12/12/2020 01:22	6,31	213	1343,85	CHI
20201262412	GOIANIA	GN11001601	REAL S2	11/12/2020 15:54	11/12/2020 18:35	11/12/2020 15:54	11/12/2020 18:35	2,68	159	425,59	CHI
20201262520	APARECIDA DE GOIANIA	AP11158615	REAL S1	11/12/2020 15:54	11/12/2020 17:25	11/12/2020 15:54	11/12/2020 17:25	1,51	81	121,93	CHI
20201262436	PLANALTINA	PI11164615	PLANALTINA	11/12/2020 15:55	11/12/2020 17:24	11/12/2020 15:55	11/12/2020 17:24	1,47	74	108,80	CHI
20201262404	TROMBAS	TB21256981	PORANGATU	11/12/2020 15:56	11/12/2020 18:59	11/12/2020 15:56	11/12/2020 18:59	3,05	1	3,05	CHI
20201262535	GOIANIA	GN10380019	FERROVIARIO S1	11/12/2020 15:56	11/12/2020 16:01	11/12/2020 15:56	11/12/2020 16:01	0,09	2285	200,57	CHI
20201262415	SAO LUIS DE MONTES BELOS	SL12167244	FIRMINOPOLIS S2	11/12/2020 15:57	11/12/2020 18:56	11/12/2020 15:57	11/12/2020 18:56	2,97	2	5,93	CHI
20201263009	CORUMBA DE GOIAS	PV12295561	CORUMBA	11/12/2020 15:58	12/12/2020 09:36	11/12/2020 15:58	12/12/2020 09:36	17,63	4	70,52	CHI
20201263009	PIRENOPOLIS	PV12295561	CORUMBA	11/12/2020 15:58	12/12/2020 09:36	11/12/2020 15:58	12/12/2020 09:36	17,63	31	546,55	CHI
20201262430	GOIATUBA	GT21052888	GOIATUBA S1	11/12/2020 15:59	12/12/2020 03:08	11/12/2020 15:59	12/12/2020 03:08	11,14	1	11,14	CHI
20201262925	GOIANIA	GN11170726	GOIANIA LESTE S1	11/12/2020 15:59	11/12/2020 21:43	11/12/2020 15:59	11/12/2020 21:43	5,72	42	240,17	CHI

20201262440	AMARALINA	LC21200457	SAO MIGUEL DO ARAGUAIA	11/12/2020 16:01	13/12/2020 10:36	11/12/2020 16:01	13/12/2020 10:36	42,58	2	85,16	CHI
20201262441	SANTA TEREZINHA DE GOIAS	SG21141134	SANTA TEREZINHA	11/12/2020 16:01	11/12/2020 17:59	11/12/2020 16:01	11/12/2020 17:59	1,96	1	1,96	CHI
20201262445	JATAI	JT21214325	JATAI S2	11/12/2020 16:01	12/12/2020 10:37	11/12/2020 16:01	12/12/2020 10:37	18,59	1	18,59	CHI
20201263184	MATRINCHA	MP12231985	MATRINCHA	11/12/2020 16:01	12/12/2020 08:23	11/12/2020 16:01	12/12/2020 08:23	16,36	3	49,09	CHI
20201262450	SAO DOMINGOS	SD12268132	SAO DOMINGOS	11/12/2020 16:02	11/12/2020 18:18	11/12/2020 16:02	11/12/2020 18:18	2,26	35	79,19	CHI
20201262470	ARAGOIANA	AO11132422	GUAPO S2	11/12/2020 16:04	11/12/2020 18:20	11/12/2020 16:04	11/12/2020 18:20	2,26	26	58,70	CHI
20201262471	PORANGATU	PO21230394	NOVO PLANALTO	11/12/2020 16:04	12/12/2020 00:59	11/12/2020 16:04	12/12/2020 00:59	8,91	1	8,91	CHI
20201262567	QUIRINOPOLIS	QI31260991	QUIRINOPOLIS	11/12/2020 16:05	11/12/2020 18:08	11/12/2020 16:05	11/12/2020 18:08	2,04	1	2,04	CHI
20201262484	CACU	CC12322236	CACHOEIRA ALTA	11/12/2020 16:07	12/12/2020 11:48	11/12/2020 16:07	12/12/2020 11:48	19,68	1	19,68	CHI
20201262500	JARAGUA	JA12000117	JARAGUA	11/12/2020 16:09	12/12/2020 11:16	11/12/2020 16:09	12/12/2020 11:16	19,10	3	57,31	CHI
20201262575	BELA VISTA DE GOIAS	BV12020433	BELA VISTA S2	11/12/2020 16:10	11/12/2020 18:22	11/12/2020 16:10	11/12/2020 18:22	2,20	9	19,79	CHI
20201262509	ITAJA	IJ12370148	ITAJA S2	11/12/2020 16:11	12/12/2020 01:05	11/12/2020 16:11	12/12/2020 01:05	8,88	2	17,77	CHI
20201262550	AGUA FRIA DE GOIAS	MJ12320111	PADRE BERNARDO	11/12/2020 16:11	11/12/2020 19:59	11/12/2020 16:11	11/12/2020 19:59	3,79	9	34,13	CHI
20201262512	RIO VERDE	10024879396	RIO VERDE S1	11/12/2020 16:12	11/12/2020 18:46	11/12/2020 16:12	11/12/2020 18:46	2,55	1	2,55	CHI
20201262515	NIQUELANDIA	NQ21135619	URUACU	11/12/2020 16:13	11/12/2020 21:53	11/12/2020 16:13	11/12/2020 21:53	5,66	1	5,66	CHI
20201262529	BOM JESUS DE GOIAS	BJ12010140	BOM JESUS DE GOIAS	11/12/2020 16:15	11/12/2020 22:02	11/12/2020 16:15	11/12/2020 22:02	5,77	4	23,07	CHI
20201262536	GOIANIA	GN12001605	AEROPORTO S2	11/12/2020 16:17	12/12/2020 06:00	11/12/2020 16:17	12/12/2020 06:00	13,71	74	1014,87	CHI
20201262538	CASTELANDIA	DM121252740	RIO DOS BOIS	11/12/2020 16:17	11/12/2020 23:48	11/12/2020 16:17	11/12/2020 23:48	7,51	7	52,55	CHI
20201262545	APARECIDA DE GOIANIA	12637191	INDEPENDENCIA S2	11/12/2020 16:18	11/12/2020 17:37	11/12/2020 16:18	11/12/2020 17:37	1,32	1	1,32	CHI
20201262551	GOIANIA	10942440	FERROVIARIO S2	11/12/2020 16:18	11/12/2020 17:58	11/12/2020 16:18	11/12/2020 17:58	1,66	1	1,66	CHI
20201262553	CRISTALINA	KR21304899	PAMPLONA	11/12/2020 16:18	11/12/2020 21:27	11/12/2020 16:18	11/12/2020 21:27	5,14	1	5,14	CHI
20201262605	APARECIDA DE GOIANIA	AP11156897	REAL S1	11/12/2020 16:18	11/12/2020 17:19	11/12/2020 16:18	11/12/2020 17:19	1,01	131	132,27	CHI
20201262755	PADRE BERNARDO	PB12317821	PADRE BERNARDO	11/12/2020 16:19	11/12/2020 18:35	11/12/2020 16:19	11/12/2020 18:35	2,26	75	169,19	CHI
20201262578	JARAGUA	JA21000176	JARAGUA	11/12/2020 16:21	12/12/2020 08:37	11/12/2020 16:21	12/12/2020 08:37	16,25	1	16,25	CHI
20201262334	VIANOPOLIS	SV12400020	VIANOPOLIS	11/12/2020 16:22	11/12/2020 22:23	11/12/2020 16:22	11/12/2020 22:23	6,01	1	6,01	CHI
20201262334	SILVANIA	SV12400020	VIANOPOLIS	11/12/2020 16:22	11/12/2020 22:23	11/12/2020 16:22	11/12/2020 22:23	6,01	46	276,36	CHI
20201262579	NIQUELANDIA	NQ21316231	NIQUELANDIA SUBTRANSMISSAO	11/12/2020 16:22	12/12/2020 01:47	11/12/2020 16:22	12/12/2020 01:47	9,41	1	9,41	CHI
20201262585	SIMOLANDIA	SA12180855	IACIARA S2	11/12/2020 16:23	11/12/2020 19:48	11/12/2020 16:23	11/12/2020 19:48	3,41	234	798,33	CHI
20201262984	ITAPIRAPUA	IU12206870	MATRINCHA	11/12/2020 16:23	12/12/2020 08:09	11/12/2020 16:23	12/12/2020 08:09	15,76	8	126,12	CHI
20201262716	COCALZINHO DE GOIAS	ZN12084617	AGUAS LINDAS DE GOIAS S2	11/12/2020 16:24	11/12/2020 20:29	11/12/2020 16:24	11/12/2020 20:29	4,07	26	105,93	CHI
20201262593	JATAI	290153220	JATAI S2	11/12/2020 16:25	11/12/2020 08:32	11/12/2020 16:25	12/12/2020 08:32	16,10	1	16,10	CHI
20201262594	ARUANA	AK12292820	BRITANIA	11/12/2020 16:25	11/12/2020 18:30	11/12/2020 16:25	11/12/2020 18:30	2,07	4	8,27	CHI
20201262603	NOVA CRIXAS	NA12027813	MOZARLANDIA	11/12/2020 16:26	11/12/2020 22:01	11/12/2020 16:26	11/12/2020 22:01	5,57	1	5,57	CHI
20201262913	SAO LUIS DE MONTES BELOS	SL11259146	SAO LUIZ DOS MONTES BELOS	11/12/2020 16:26	11/12/2020 19:35	11/12/2020 16:26	11/12/2020 19:35	3,15	34	107,00	CHI
20201262906	ARAGOIANA	AO32021484	GUAPO S2	11/12/2020 16:27	11/12/2020 20:13	11/12/2020 16:27	11/12/2020 20:13	3,76	5	18,78	CHI
20201263186	MUTUNOPOLIS	MU12320905	MARA ROSA	11/12/2020 16:27	11/12/2020 21:58	11/12/2020 16:27	11/12/2020 21:58	5,51	6	33,05	CHI
20201262612	CAIAPONIA	CP12231263LD	MONTIVIDIU T	11/12/2020 16:28	12/12/2020 19:27	11/12/2020 16:28	12/12/2020 19:27	26,98	73	1969,30	CHI
20201262616	CAMPO ALEGRE DE GOIAS	CM21042423	CAMPO ALEGRE DE GOIAS	11/12/2020 16:28	12/12/2020 11:37	11/12/2020 16:28	12/12/2020 11:37	19,13	1	19,13	CHI
20201262630	BELA VISTA DE GOIAS	BV12402718	BELA VISTA S1	11/12/2020 16:28	11/12/2020 19:46	11/12/2020 16:28	11/12/2020 19:46	3,30	13	42,84	CHI
20201262687	CRISTALINA	KR12160112	CRISTALINA S2	11/12/2020 16:28	11/12/2020 20:32	11/12/2020 16:28	11/12/2020 20:32	4,06	18	73,02	CHI
20201262618	APARECIDA DE GOIANIA	15524358	INDEPENDENCIA S1	11/12/2020 16:29	11/12/2020 19:31	11/12/2020 16:29	11/12/2020 19:31	3,03	1	3,03	CHI
20201262692	CRISTALINA	KR12304869	CRISTALINA S2	11/12/2020 16:29	11/12/2020 21:36	11/12/2020 16:29	11/12/2020 21:36	5,11	16	81,74	CHI
20201262623	COCALZINHO DE GOIAS	CB21028345	COCALZINHO	11/12/2020 16:30	11/12/2020 21:43	11/12/2020 16:30	11/12/2020 21:43	5,21	1	5,21	CHI
20201262626	CRISTALINA	KR11040618	CRISTALINA S1	11/12/2020 16:30	11/12/2020 18:50	11/12/2020 16:30	11/12/2020 18:50	2,33	171	398,81	CHI
20201262633	ITUMBIARA	IT21304285	PARANAIBA	11/12/2020 16:32	11/12/2020 19:32	11/12/2020 16:32	11/12/2020 19:32	3,00	1	3,00	CHI
20201262640	GOIANIA	GN11167920	GOIANIA LESTE S3	11/12/2020 16:33	12/12/2020 03:06	11/12/2020 16:33	12/12/2020 03:06	10,55	8	84,38	CHI
20201262930	LUZIANIA	LZ11209614	MARAJOARA	11/12/2020 16:33	11/12/2020 21:46	11/12/2020 16:33	11/12/2020 21:46	5,21	34	176,97	CHI
20201262647	PIRANHAS	PH21092244	BOM JARDIM	11/12/2020 16:34	11/12/2020 18:41	11/12/2020 16:34	11/12/2020 18:41	2,11	1	2,11	CHI
20201262663	ITUMBIARA	10015629390	PARANAIBA	11/12/2020 16:38	11/12/2020 21:30	11/12/2020 16:38	11/12/2020 21:30	4,86	1	4,86	CHI
20201262688	CRIXAS	MZ10404285	MOZARLANDIA	11/12/2020 16:39	13/12/2020 21:20	11/12/2020 16:39	11/12/2020 19:50	3,18	26	82,77	CHI
20201262688	MOZARLANDIA	MZ10404285	MOZARLANDIA	11/12/2020 16:39	13/12/2020 21:20	11/12/2020 16:39	11/12/2020 19:50	3,18	74	235,57	CHI

20201262688	MOZARLANDIA	MZ10404285	MOZARLANDIA	11/12/2020 16:39	13/12/2020 21:20	11/12/2020 16:39	11/12/2020 23:44	7,08	2	14,17	CHI
20201262688	NOVA CRIXAS	MZ10404285	MOZARLANDIA	11/12/2020 16:39	13/12/2020 21:20	11/12/2020 16:39	11/12/2020 23:44	7,08	24	170,03	CHI
20201262688	MOZARLANDIA	MZ12150974LD	MOZARLANDIA	11/12/2020 16:39	13/12/2020 21:20	11/12/2020 16:39	12/12/2020 01:06	8,44	3	25,33	CHI
20201262688	CRIXAS	MZ12150974LD	MOZARLANDIA	11/12/2020 16:39	13/12/2020 21:20	11/12/2020 16:39	12/12/2020 01:06	8,44	74	624,81	CHI
20201262688	NOVA CRIXAS	MZ12150974LD	MOZARLANDIA	11/12/2020 16:39	13/12/2020 21:20	11/12/2020 16:39	12/12/2020 01:06	8,44	4	33,77	CHI
20201262688	NOVA CRIXAS	MZ18055650TS	MOZARLANDIA	11/12/2020 16:39	13/12/2020 21:20	12/12/2020 01:09	12/12/2020 01:19	0,16	24	3,83	CHI
20201262688	MOZARLANDIA	MZ18055650TS	MOZARLANDIA	11/12/2020 16:39	13/12/2020 21:20	12/12/2020 01:09	12/12/2020 01:19	0,16	2	0,32	CHI
20201262688	NOVA CRIXAS	MZ12150974LD	MOZARLANDIA	11/12/2020 16:39	13/12/2020 21:20	12/12/2020 01:09	12/12/2020 12:18	11,15	4	44,59	CHI
20201262688	CRIXAS	MZ12150974LD	MOZARLANDIA	11/12/2020 16:39	13/12/2020 21:20	12/12/2020 01:09	12/12/2020 12:18	11,15	4	44,59	CHI
20201262688	NOVA CRIXAS	MZ10404285	MOZARLANDIA	11/12/2020 16:39	13/12/2020 21:20	12/12/2020 18:19	12/12/2020 18:38	0,32	28	8,90	CHI
20201262688	MOZARLANDIA	MZ10404285	MOZARLANDIA	11/12/2020 16:39	13/12/2020 21:20	12/12/2020 18:19	12/12/2020 18:38	0,32	78	24,79	CHI
20201262688	CRIXAS	MZ10404285	MOZARLANDIA	11/12/2020 16:39	13/12/2020 21:20	12/12/2020 18:19	12/12/2020 18:38	0,32	29	9,22	CHI
20201262688	CRIXAS	CX13307450	MOZARLANDIA	11/12/2020 16:39	13/12/2020 21:20	12/12/2020 01:09	13/12/2020 21:20	44,18	49	2164,70	CHI
20201262688	CRIXAS	MZ12150974LD	MOZARLANDIA	11/12/2020 16:39	13/12/2020 21:20	12/12/2020 01:09	13/12/2020 21:20	44,18	21	927,73	CHI
20201262688	MOZARLANDIA	MZ12150974LD	MOZARLANDIA	11/12/2020 16:39	13/12/2020 21:20	12/12/2020 01:09	13/12/2020 21:20	44,18	3	132,53	CHI
20201262679	CAMPOS BELOS	CH12264917	SAO DOMINGOS	11/12/2020 16:41	11/12/2020 18:40	11/12/2020 16:41	11/12/2020 18:40	1,98	11	21,75	CHI
20201262877	FIRMINOPOLIS	SL12111560RE	FIRMINOPOLIS S1	11/12/2020 16:42	11/12/2020 21:39	11/12/2020 16:42	11/12/2020 21:39	4,95	6	29,69	CHI
20201262877	SAO LUIS DE MONTES BELOS	SL12111560RE	FIRMINOPOLIS S1	11/12/2020 16:42	11/12/2020 21:39	11/12/2020 16:42	11/12/2020 21:39	4,95	34	168,22	CHI
20201262695	GOIANIA	GN11151331	GOIANIA LESTE S3	11/12/2020 16:43	11/12/2020 19:02	11/12/2020 16:43	11/12/2020 19:02	2,30	3	6,91	CHI
20201262709	NOVA CRIXAS	NA12334349	NOVA CRIXAS	11/12/2020 16:45	12/12/2020 21:48	11/12/2020 16:45	12/12/2020 21:48	29,05	85	2469,18	CHI
20201262715	NIQUELANDIA	10005745789	NIQUELANDIA SUBTRANSMISSAO	11/12/2020 16:45	11/12/2020 19:36	11/12/2020 16:45	11/12/2020 19:36	2,84	1	2,84	CHI
20201262830	MONTIVIDIU	MV12301552	MONTIVIDIU T	11/12/2020 16:45	12/12/2020 00:02	11/12/2020 16:45	12/12/2020 00:02	7,28	9	65,48	CHI
20201262721	FAINA	2580023921	GOIAS	11/12/2020 16:46	11/12/2020 23:41	11/12/2020 16:46	11/12/2020 23:41	6,90	1	6,90	CHI
20201263057	PORANGATU	PO12390255	PORANGATU	11/12/2020 16:47	11/12/2020 21:37	11/12/2020 16:47	11/12/2020 21:37	4,82	4	19,30	CHI
20201262727	CATALAO	1990151751	CATALAO S2	11/12/2020 16:48	12/12/2020 01:53	11/12/2020 16:48	12/12/2020 01:53	9,08	1	9,08	CHI
20201262734	GOIANIA	10646607	AEROPORTO S3	11/12/2020 16:49	11/12/2020 19:07	11/12/2020 16:49	11/12/2020 19:07	2,29	1	2,29	CHI
20201262738	FLORES DE GOIAS	FB21419146	FLORES DE GOIAS	11/12/2020 16:49	11/12/2020 20:19	11/12/2020 16:49	11/12/2020 20:19	3,48	1	3,48	CHI
20201262742	INDIARA	IY21392949	ACREUNA	11/12/2020 16:50	13/12/2020 09:14	11/12/2020 16:50	13/12/2020 09:14	40,39	1	40,39	CHI
20201262744	DOVERLANDIA	DV12207836	CAIAPONIA	11/12/2020 16:50	12/12/2020 20:00	11/12/2020 16:50	12/12/2020 20:00	27,16	11	298,76	CHI
20201262747	RIO VERDE	RV21093054	RIO VERDE S1	11/12/2020 16:50	11/12/2020 19:38	11/12/2020 16:50	11/12/2020 19:38	2,78	1	2,78	CHI
20201262776	GOIANIA	GN10385851	REAL S1	11/12/2020 16:52	12/12/2020 01:07	11/12/2020 16:52	11/12/2020 17:32	0,66	613	407,47	CHI
20201262776	GOIANIA	GN12000169LD	REAL S1	11/12/2020 16:52	12/12/2020 01:07	11/12/2020 16:52	12/12/2020 01:07	8,25	974	8037,39	CHI
20201262773	PIRANHAS	PH12188274	PIRANHAS	11/12/2020 16:54	11/12/2020 22:01	11/12/2020 16:54	11/12/2020 22:01	5,10	1	5,10	CHI
20201262778	CRISTALINA	KR12330572	PAMPLONA	11/12/2020 16:55	11/12/2020 21:12	11/12/2020 16:55	11/12/2020 21:12	4,28	2	8,55	CHI
20201262782	MIMOSO DE GOIAS	MJ21348995	PADRE BERNARDO	11/12/2020 16:56	12/12/2020 08:27	11/12/2020 16:56	12/12/2020 08:27	15,51	1	15,51	CHI
20201262783	MUTUNOPOLIS	MU12129781	MARA ROSA	11/12/2020 16:56	11/12/2020 20:53	11/12/2020 16:56	11/12/2020 20:53	3,94	7	27,57	CHI
20201262799	GOIANIA	10008932512	CAMPINAS S2	11/12/2020 16:59	11/12/2020 21:47	11/12/2020 16:59	11/12/2020 21:47	4,80	1	4,80	CHI
20201262801	ALTO HORIZONTE	AJ21135677	SANTA TEREZINHA	11/12/2020 16:59	11/12/2020 21:04	11/12/2020 16:59	11/12/2020 21:04	4,08	1	4,08	CHI
20201262805	MARA ROSA	2260004940	MARA ROSA	11/12/2020 17:00	11/12/2020 22:55	11/12/2020 17:00	11/12/2020 22:55	5,90	1	5,90	CHI
20201262808	APARECIDA DE GOIANIA	200329625	INDEPENDENCIA S1	11/12/2020 17:01	11/12/2020 20:20	11/12/2020 17:01	11/12/2020 20:20	3,31	1	3,31	CHI
20201262811	JANDAIA	JD21328166	PALMEIRAS	11/12/2020 17:02	11/12/2020 20:52	11/12/2020 17:02	11/12/2020 20:52	3,83	1	3,83	CHI
20201262817	SAO LUIZ DO NORTE	3090007512	ITAPACI	11/12/2020 17:02	11/12/2020 20:07	11/12/2020 17:02	11/12/2020 20:07	3,07	1	3,07	CHI
20201262821	CAMPO ALEGRE DE GOIAS	CM12086086	CAMPO ALEGRE DE GOIAS	11/12/2020 17:04	12/12/2020 13:10	11/12/2020 17:04	12/12/2020 13:10	20,10	6	120,60	CHI
20201262823	PLANALTINA	2960089930	PLANALTINA	11/12/2020 17:04	11/12/2020 19:33	11/12/2020 17:04	11/12/2020 19:33	2,48	1	2,48	CHI
20201262824	SAO LUIS DE MONTES BELOS	SL21145950	SAO LUIZ DOS MONTES BELOS	11/12/2020 17:04	11/12/2020 21:40	11/12/2020 17:04	11/12/2020 21:40	4,59	1	4,59	CHI
20201262827	SILVANIA	SV21094739	DAIA S2	11/12/2020 17:04	11/12/2020 21:19	11/12/2020 17:04	11/12/2020 21:19	4,24	1	4,24	CHI
20201262828	EDEALINA	ED21108416	PONTALINA	11/12/2020 17:05	12/12/2020 04:56	11/12/2020 17:05	12/12/2020 04:56	11,85	2	23,70	CHI
20201262836	URUACU	UR12201756	URUACU	11/12/2020 17:06	11/12/2020 20:19	11/12/2020 17:06	11/12/2020 20:19	3,20	3	9,61	CHI
20201262841	TRINDADE	40055050	TRINDADE	11/12/2020 17:07	11/12/2020 21:34	11/12/2020 17:07	11/12/2020 21:34	4,44	1	4,44	CHI
20201262842	JARAGUA	JA21049593	JARAGUA	11/12/2020 17:07	12/12/2020 01:06	11/12/2020 17:07	12/12/2020 01:06	7,97	3	23,91	CHI
20201262846	CRISTALINA	KR12110413	CRISTALINA S2	11/12/2020 17:08	11/12/2020 20:17	11/12/2020 17:08	11/12/2020 20:17	3,15	6	18,90	CHI

20201262850	GOIANIA	12808167	ATLANTICO S3	11/12/2020 17:09	11/12/2020 18:48	11/12/2020 17:09	11/12/2020 18:48	1,65	1	1,65	CHI
20201262855	LUZIANIA	LZ21381863	MARAJOARA	11/12/2020 17:10	12/12/2020 00:09	11/12/2020 17:10	12/12/2020 00:09	6,98	1	6,98	CHI
20201262858	BELA VISTA DE GOIAS	BV12033288	BELA VISTA S1	11/12/2020 17:10	11/12/2020 21:08	11/12/2020 17:10	11/12/2020 21:08	3,96	4	15,84	CHI
20201263946	SILVANIA	SV12202383	CEPAIGO S2	11/12/2020 17:10	12/12/2020 00:47	11/12/2020 17:10	12/12/2020 00:47	7,61	4	30,45	CHI
20201263946	CALDAZINHA	SV12202383	CEPAIGO S2	11/12/2020 17:10	12/12/2020 00:47	11/12/2020 17:10	12/12/2020 00:47	7,61	14	106,56	CHI
20201262860	ITUMBIARA	10016535322	ITUMBIARA NOVA	11/12/2020 17:11	11/12/2020 21:40	11/12/2020 17:11	11/12/2020 21:40	4,48	1	4,48	CHI
20201262910	PARAUNA	PU12391518	PARAUNA	11/12/2020 17:11	12/12/2020 07:17	11/12/2020 17:11	12/12/2020 07:17	14,08	26	366,18	CHI
20201262867	CAIAPONIA	930009848	CAIAPONIA	11/12/2020 17:14	12/12/2020 12:45	11/12/2020 17:14	12/12/2020 12:45	19,52	1	19,52	CHI
20201263642	INHUMAS	IN11012225	INHUMAS S2	11/12/2020 17:15	11/12/2020 20:47	11/12/2020 17:15	11/12/2020 20:47	3,52	68	239,15	CHI
20201262879	SAO LUIS DE MONTES BELOS	SL31111604	FIRMINOPOLIS S1	11/12/2020 17:17	11/12/2020 22:37	11/12/2020 17:17	11/12/2020 22:37	5,32	1	5,32	CHI
20201262885	AMARALINA	LC21278475	MARA ROSA	11/12/2020 17:18	13/12/2020 08:50	11/12/2020 17:18	13/12/2020 08:50	39,52	1	39,52	CHI
20201262929	APARECIDA DE GOIANIA	AP11276931	INDEPENDENCIA S1	11/12/2020 17:18	11/12/2020 19:18	11/12/2020 17:18	11/12/2020 19:18	1,99	116	230,49	CHI
20201262887	CRIXAS	CX12295212	SERRA DO OURO	11/12/2020 17:19	12/12/2020 02:09	11/12/2020 17:19	12/12/2020 02:09	8,83	28	247,25	CHI
20201263212	PILAR DE GOIAS	GG12181017	SANTA TEREZINHA	11/12/2020 17:20	11/12/2020 23:43	11/12/2020 17:20	11/12/2020 23:43	6,37	9	57,37	CHI
20201262894	JANDAIA	JD21104577	PALMEIRAS	11/12/2020 17:21	11/12/2020 21:36	11/12/2020 17:21	11/12/2020 21:36	4,25	2	8,50	CHI
20201262899	ITUMBIARA	690178128	ITUMBIARA VELHA S1	11/12/2020 17:21	11/12/2020 22:24	11/12/2020 17:21	11/12/2020 22:24	5,04	1	5,04	CHI
20201262904	APARECIDA DE GOIANIA	15454010	INDEPENDENCIA S1	11/12/2020 17:22	11/12/2020 22:40	11/12/2020 17:22	11/12/2020 22:40	5,30	1	5,30	CHI
20201262963	SAO LUIS DE MONTES BELOS	SL32111610	FIRMINOPOLIS S1	11/12/2020 17:25	11/12/2020 22:08	11/12/2020 17:25	11/12/2020 22:08	4,70	30	141,06	CHI
20201262920	MUNDO NOVO DE GOIAS	4240005426	NOVA CRIXAS	11/12/2020 17:26	12/12/2020 05:18	11/12/2020 17:26	12/12/2020 05:18	11,86	1	11,86	CHI
20201262928	FORMOSA	FA12261996	ITUIQUIRA	11/12/2020 17:28	11/12/2020 23:50	11/12/2020 17:28	11/12/2020 23:50	6,36	4	25,45	CHI
20201263291	JARAGUA	JA12278881	JARAGUA	11/12/2020 17:28	11/12/2020 21:39	11/12/2020 17:28	11/12/2020 21:39	4,18	12	50,20	CHI
20201262939	CHAPADAO DO CEU	9880014230	CHAPADAO DO CEU	11/12/2020 17:30	11/12/2020 20:38	11/12/2020 17:30	11/12/2020 20:38	3,13	1	3,13	CHI
20201262941	GOIANIA	GN21133779	CEPAIGO S1	11/12/2020 17:31	11/12/2020 22:53	11/12/2020 17:31	11/12/2020 22:53	5,37	2	10,73	CHI
20201262950	PONTALINA	PK21346389	PONTALINA	11/12/2020 17:32	11/12/2020 19:35	11/12/2020 17:32	11/12/2020 19:35	2,04	1	2,04	CHI
20201262955	CAMPO ALEGRE DE GOIAS	CM21203073	CAMPO ALEGRE DE GOIAS	11/12/2020 17:33	12/12/2020 10:52	11/12/2020 17:33	12/12/2020 10:52	17,30	1	17,30	CHI
20201263755	JATAI	JT12264404	JATAI S1	11/12/2020 17:33	11/12/2020 22:47	11/12/2020 17:33	11/12/2020 22:47	5,22	6	31,32	CHI
20201262962	ITUMBIARA	10024488591	ITUMBIARA VELHA S1	11/12/2020 17:36	11/12/2020 22:44	11/12/2020 17:36	11/12/2020 22:44	5,13	1	5,13	CHI
20201262965	ITUMBIARA	690349233	ITUMBIARA NOVA	11/12/2020 17:36	11/12/2020 20:41	11/12/2020 17:36	11/12/2020 20:41	3,08	1	3,08	CHI
20201262966	PIRES DO RIO	BC12051685	PIRES DO RIO S2	11/12/2020 17:36	11/12/2020 21:42	11/12/2020 17:36	11/12/2020 21:42	4,09	64	261,78	CHI
20201262966	SANTA CRUZ DE GOIAS	BC12051685	PIRES DO RIO S2	11/12/2020 17:36	11/12/2020 21:42	11/12/2020 17:36	11/12/2020 21:42	4,09	27	110,44	CHI
20201262967	RIO VERDE	10012708095	RIO VERDE S1	11/12/2020 17:36	11/12/2020 19:21	11/12/2020 17:36	11/12/2020 19:21	1,74	1	1,74	CHI
20201262968	GUARANI DE GOIAS	GY12393812	IACIARA S1	11/12/2020 17:36	11/12/2020 20:31	11/12/2020 17:36	11/12/2020 20:31	2,91	22	63,94	CHI
20201262974	NOVO PLANALTO	TA11293683	SAO MIGUEL DO ARAGUAIA	11/12/2020 17:37	11/12/2020 21:26	11/12/2020 17:37	11/12/2020 21:26	3,81	1	3,81	CHI
20201262979	SENADOR CANEDO	SW12080143	SENADOR CANEDO	11/12/2020 17:38	11/12/2020 19:54	11/12/2020 17:38	11/12/2020 19:54	2,25	5	11,26	CHI
20201264150	PROFESSOR JAMIL SAFADY	PJ13375764B	PIRACANJUBA	11/12/2020 17:38	12/12/2020 05:12	11/12/2020 17:38	12/12/2020 05:12	11,57	3	34,70	CHI
20201264150	PIRACANJUBA	PJ13375764B	PIRACANJUBA	11/12/2020 17:38	12/12/2020 05:12	11/12/2020 17:38	12/12/2020 05:12	11,57	313	3620,45	CHI
20201262986	SANTA RITA DO ARAGUAIA	2130005580	SANTA RITA DO ARAGUAIA	11/12/2020 17:40	12/12/2020 10:39	11/12/2020 17:40	12/12/2020 10:39	16,98	1	16,98	CHI
20201262989	GOIANIA	10007817167	CAMPINAS S1	11/12/2020 17:40	11/12/2020 22:35	11/12/2020 17:40	11/12/2020 22:35	4,91	1	4,91	CHI
20201263138	LUZIANIA	LZ11000284	RIO VERMELHO	11/12/2020 17:40	11/12/2020 22:07	11/12/2020 17:40	11/12/2020 22:07	4,44	41	182,04	CHI
20201263296	GOIANIA	GN12054915	XAVANTES	11/12/2020 17:40	11/12/2020 20:59	11/12/2020 17:40	11/12/2020 20:59	3,31	26	85,95	CHI
20201262998	ALEXANIA	AX11000006	ALEXANIA	11/12/2020 17:42	11/12/2020 21:53	11/12/2020 17:42	11/12/2020 21:53	4,18	75	313,60	CHI
20201262999	NIQUELANDIA	NQ21342782	BARRO ALTO	11/12/2020 17:42	11/12/2020 23:03	11/12/2020 17:42	11/12/2020 23:03	5,35	1	5,35	CHI
20201263001	COCALZINHO DE GOIAS	ZN21063260	AGUAS LINDAS DE GOIAS S2	11/12/2020 17:42	11/12/2020 19:37	11/12/2020 17:42	11/12/2020 19:37	1,91	2	3,82	CHI
20201263005	PLANALTINA	10015939837	PLANALTINA	11/12/2020 17:43	11/12/2020 20:11	11/12/2020 17:43	11/12/2020 20:11	2,47	1	2,47	CHI
20201263087	COCALZINHO DE GOIAS	CB12043409	COCALZINHO	11/12/2020 17:43	11/12/2020 20:18	11/12/2020 17:43	11/12/2020 20:18	2,58	20	51,61	CHI
20201263012	CALDAS NOVAS	760021200	SERRA DE CALDAS	11/12/2020 17:45	11/12/2020 18:48	11/12/2020 17:45	11/12/2020 18:48	1,05	1	1,05	CHI
20201263013	CRIXAS	CX11083039	SERRA DO OURO	11/12/2020 17:45	11/12/2020 22:41	11/12/2020 17:45	11/12/2020 22:41	4,93	4	19,72	CHI
20201263019	SANTA CRUZ DE GOIAS	BC21186567	CRISTIANOPOLIS	11/12/2020 17:46	11/12/2020 21:10	11/12/2020 17:46	11/12/2020 21:10	3,39	1	3,39	CHI
20201263023	GAMELEIRA DE GOIAS	SV12077018	DAIA S2	11/12/2020 17:46	11/12/2020 20:24	11/12/2020 17:46	11/12/2020 20:24	2,63	3	7,88	CHI
20201263030	GOIANIA	12832560	GOIANIA LESTE S3	11/12/2020 17:48	11/12/2020 20:02	11/12/2020 17:48	11/12/2020 20:02	2,22	1	2,22	CHI
20201263333	CATALAO	CT12061234	CATALAO S1	11/12/2020 17:49	11/12/2020 22:24	11/12/2020 17:49	11/12/2020 22:24	4,57	17	77,74	CHI

20201263045	GOIANIA	13154394	XAVANTES	11/12/2020 17:51	11/12/2020 22:59	11/12/2020 17:51	11/12/2020 22:59	5,13	1	5,13	CHI
20201263046	JATAI	290295490	JATAI S2	11/12/2020 17:51	12/12/2020 12:08	11/12/2020 17:51	12/12/2020 12:08	18,28	1	18,28	CHI
20201263053	LEOPOLDO DE BULHOES	LB12100600	DAIA S2	11/12/2020 17:53	11/12/2020 23:49	11/12/2020 17:53	11/12/2020 23:49	5,93	54	319,96	CHI
20201263377	DOVERLANDIA	DV12139906	CAIAPONIA	11/12/2020 17:54	12/12/2020 07:46	11/12/2020 17:54	12/12/2020 07:46	13,86	10	138,56	CHI
20201263384	SANTO ANTONIO DA BARRA	BZ12303302	ACREUNA	11/12/2020 17:54	12/12/2020 00:15	11/12/2020 17:54	12/12/2020 00:15	6,33	12	76,02	CHI
20201263064	APARECIDA DE GOIANIA	AP21162018	CEPAIGO S1	11/12/2020 17:55	11/12/2020 20:46	11/12/2020 17:55	11/12/2020 20:46	2,85	1	2,85	CHI
20201263250	ANAPOLIS	AN12258125	ANAPOLIS UNIVERSITARIO S2	11/12/2020 17:55	11/12/2020 19:40	11/12/2020 17:55	11/12/2020 19:40	1,74	372	648,83	CHI
20201263112	LUZIANIA	LZ12330544	MARAJOARA	11/12/2020 17:56	11/12/2020 23:01	11/12/2020 17:56	11/12/2020 23:01	5,07	8	40,55	CHI
20201263287	PORANGATU	PO12192252	PORANGATU	11/12/2020 18:00	11/12/2020 23:15	11/12/2020 18:00	11/12/2020 23:15	5,23	25	130,87	CHI
20201263100	APARECIDA DE GOIANIA	10001922163	INDEPENDENCIA S2	11/12/2020 18:03	11/12/2020 20:10	11/12/2020 18:03	11/12/2020 20:10	2,11	1	2,11	CHI
20201263762	CRISTALINA	KR12153067	CRISTALINA S2	11/12/2020 18:05	12/12/2020 12:40	11/12/2020 18:05	12/12/2020 12:40	18,58	3	55,74	CHI
20201263111	GOIAS	90022543	GOIAS	11/12/2020 18:06	12/12/2020 08:56	11/12/2020 18:06	12/12/2020 08:56	14,82	1	14,82	CHI
20201263117	ITUMBIARA	690347390	ITUMBIARA VELHA S1	11/12/2020 18:08	12/12/2020 07:48	11/12/2020 18:08	12/12/2020 07:48	13,66	1	13,66	CHI
20201263125	GOIAS	GS21274361	GOIAS	11/12/2020 18:10	11/12/2020 23:29	11/12/2020 18:10	11/12/2020 23:29	5,31	1	5,31	CHI
20201263129	SANTA HELENA DE GOIAS	SH21301724	ACREUNA	11/12/2020 18:11	11/12/2020 20:10	11/12/2020 18:11	11/12/2020 20:10	1,97	4	7,88	CHI
20201263131	RIO VERDE	630104189	RIO VERDE S1	11/12/2020 18:12	12/12/2020 09:57	11/12/2020 18:12	12/12/2020 09:57	15,74	1	15,74	CHI
20201263133	GOIANIA	10013205550	CAMPINAS S2	11/12/2020 18:13	11/12/2020 22:33	11/12/2020 18:13	11/12/2020 22:33	4,33	1	4,33	CHI
20201263137	TRES RANCHOS	TH12195259RE	CATALAO S1	11/12/2020 18:13	11/12/2020 20:30	11/12/2020 18:13	11/12/2020 20:30	2,28	248	564,96	CHI
20201263140	CAMPOS VERDES	SG12335777	SANTA TEREZINHA	11/12/2020 18:13	11/12/2020 23:16	11/12/2020 18:13	11/12/2020 23:16	5,04	1	5,04	CHI
20201263142	CRIXAS	CX12055157	SERRA DO OURO	11/12/2020 18:14	12/12/2020 03:23	11/12/2020 18:14	12/12/2020 03:23	9,14	8	73,16	CHI
20201263144	RUBIATABA	RB12201363	RUBIATABA	11/12/2020 18:14	11/12/2020 23:43	11/12/2020 18:14	11/12/2020 23:43	5,48	2	10,95	CHI
20201263156	APARECIDA DE GOIANIA	10024171458	INDEPENDENCIA S1	11/12/2020 18:16	11/12/2020 20:48	11/12/2020 18:16	11/12/2020 20:48	2,53	1	2,53	CHI
20201263163	CRISTALINA	KR21139066	CRISTALINA S1	11/12/2020 18:17	12/12/2020 12:05	11/12/2020 18:17	12/12/2020 12:05	17,79	1	17,79	CHI
20201263164	CAMPO ALEGRE DE GOIAS	CM12347169	CAMPO ALEGRE DE GOIAS	11/12/2020 18:17	11/12/2020 22:32	11/12/2020 18:17	11/12/2020 22:32	4,24	7	29,66	CHI
20201263191	MONTIVIDIU DO NORTE	MX12203423	PORANGATU	11/12/2020 18:17	11/12/2020 22:18	11/12/2020 18:17	11/12/2020 22:18	4,00	17	68,04	CHI
20201263382	HIDROLANDIA	180054030	BELA VISTA S1	11/12/2020 18:17	11/12/2020 23:00	11/12/2020 18:17	11/12/2020 23:00	4,71	1	4,71	CHI
20201263171	PARAUNA	PU21301681	ACREUNA	11/12/2020 18:19	12/12/2020 08:21	11/12/2020 18:19	12/12/2020 08:21	14,03	1	14,03	CHI
20201263174	MINACU	IH21192326	MINACU	11/12/2020 18:19	12/12/2020 09:14	11/12/2020 18:19	12/12/2020 09:14	14,90	1	14,90	CHI
20201263244	RIO VERDE	RV12303300	ACREUNA	11/12/2020 18:19	12/12/2020 10:20	11/12/2020 18:19	12/12/2020 10:20	16,01	3	48,03	CHI
20201263179	MUNDO NOVO DE GOIAS	MH11357663	NOVA CRIXAS	11/12/2020 18:21	11/12/2020 20:02	11/12/2020 18:21	11/12/2020 20:02	1,68	1	1,68	CHI
20201263180	QUIRINOPOLIS	QI21101234	QUIRINOPOLIS	11/12/2020 18:21	12/12/2020 02:56	11/12/2020 18:21	12/12/2020 02:56	8,58	1	8,58	CHI
20201263181	RUBIATABA	RB21068756	RUBIATABA	11/12/2020 18:21	11/12/2020 21:35	11/12/2020 18:21	11/12/2020 21:35	3,23	1	3,23	CHI
20201263182	GOIANIA	GN11001819	AEROPORTO S2	11/12/2020 18:21	11/12/2020 22:13	11/12/2020 22:05	11/12/2020 22:13	0,14	5	0,70	CHI
20201263183	APARECIDA DE GOIANIA	17122958	REAL S1	11/12/2020 18:21	11/12/2020 19:33	11/12/2020 18:21	11/12/2020 19:33	1,20	1	1,20	CHI
20201263188	MONTIVIDIU	MV21091854	MONTIVIDIU T	11/12/2020 18:21	12/12/2020 02:18	11/12/2020 18:21	12/12/2020 02:18	7,94	1	7,94	CHI
20201263194	IPAMERI	IP12057877RE	PIRES DO RIO S2	11/12/2020 18:23	12/12/2020 15:10	11/12/2020 18:23	12/12/2020 15:10	20,78	17	353,30	CHI
20201263195	TRINDADE	10007874322	GOYA S2	11/12/2020 18:23	11/12/2020 19:27	11/12/2020 18:23	11/12/2020 19:27	1,06	1	1,06	CHI
20201263306	ANICUNS	AC11361630	ANICUNS	11/12/2020 18:24	11/12/2020 19:28	11/12/2020 18:24	11/12/2020 19:28	1,06	63	66,83	CHI
20201263222	PONTALINA	PK32046032	PONTALINA	11/12/2020 18:26	12/12/2020 07:45	11/12/2020 18:26	12/12/2020 07:45	13,31	15	199,70	CHI
20201263215	PIRENOPOLIS	PV21062020	SAO FRANCISCO DE GOIAS	11/12/2020 18:28	11/12/2020 23:11	11/12/2020 18:28	11/12/2020 23:11	4,72	2	9,43	CHI
20201263253	CEZARINA	CZ12314845	CEZARINA	11/12/2020 18:28	11/12/2020 19:43	11/12/2020 18:28	11/12/2020 19:43	1,24	8	9,95	CHI
20201263225	PIRES DO RIO	PR21073003	PIRES DO RIO S1	11/12/2020 18:29	12/12/2020 07:49	11/12/2020 18:29	12/12/2020 07:49	13,32	1	13,32	CHI
20201263226	DIORAMA	DI12024594	ARENOPOLIS	11/12/2020 18:29	12/12/2020 00:01	11/12/2020 18:29	12/12/2020 00:01	5,53	5	27,67	CHI
20201263236	SENADOR CANEDO	190107571	SENADOR CANEDO	11/12/2020 18:32	11/12/2020 21:11	11/12/2020 18:32	11/12/2020 21:11	2,63	1	2,63	CHI
20201263240	ANHANGUERA	AH11000072	CATALAO S1	11/12/2020 18:33	11/12/2020 20:11	11/12/2020 18:33	11/12/2020 20:11	1,62	103	167,26	CHI
20201263246	FORMOSA	610252033	ITIQUIRA	11/12/2020 18:34	11/12/2020 20:23	11/12/2020 18:34	11/12/2020 20:23	1,82	1	1,82	CHI
20201263467	CAIAPONIA	CP12301812	CAIAPONIA	11/12/2020 18:34	11/12/2020 22:52	11/12/2020 18:34	11/12/2020 22:52	4,29	9	38,57	CHI
20201263724	CRIXAS	CX12202125	SERRA DO OURO	11/12/2020 18:34	11/12/2020 23:16	11/12/2020 18:34	11/12/2020 23:16	4,69	3	14,07	CHI
20201263256	ANAPOLIS	10020023179	JUNDIAI S2	11/12/2020 18:36	11/12/2020 23:31	11/12/2020 18:36	11/12/2020 23:31	4,91	1	4,91	CHI
20201263263	ABADIA DE GOIAS	TR31050565	TRINDADE	11/12/2020 18:38	11/12/2020 21:39	11/12/2020 18:38	11/12/2020 21:39	3,01	1	3,01	CHI
20201263266	GOIANIA	11493793	CAMPINAS S2	11/12/2020 18:39	11/12/2020 20:08	11/12/2020 18:39	11/12/2020 20:08	1,48	1	1,48	CHI

20201263267	JATAI	JT21106067	JATAI S2	11/12/2020 18:39	12/12/2020 07:40	11/12/2020 18:39	12/12/2020 07:40	13,01	1	13,01	CHI
20201263271	FORMOSA	FA21013377	ITIQUEIRA	11/12/2020 18:40	12/12/2020 04:39	11/12/2020 18:40	12/12/2020 04:39	9,99	1	9,99	CHI
20201263276	TRINDADE	10010194620	TRINDADE	11/12/2020 18:41	11/12/2020 22:04	11/12/2020 18:41	11/12/2020 22:04	3,37	1	3,37	CHI
20201263281	CORREGO DO OURO	CO21081205	FIRMINOPOLIS S2	11/12/2020 18:42	11/12/2020 19:47	11/12/2020 18:42	11/12/2020 19:47	1,07	1	1,07	CHI
20201263282	ITARUMA	IJ13306274	CACHOEIRA ALTA	11/12/2020 18:43	12/12/2020 14:28	11/12/2020 18:43	12/12/2020 14:28	19,76	1	19,76	CHI
20201263282	ITAJA	IJ13306274	CACHOEIRA ALTA	11/12/2020 18:43	12/12/2020 14:28	11/12/2020 18:43	12/12/2020 14:28	19,76	1	19,76	CHI
20201263282	LAGOA SANTA	IJ13306274	CACHOEIRA ALTA	11/12/2020 18:43	12/12/2020 14:28	12/12/2020 11:26	12/12/2020 14:28	3,04	13	39,47	CHI
20201263282	ITAJA	IJ13306274	CACHOEIRA ALTA	11/12/2020 18:43	12/12/2020 14:28	12/12/2020 11:26	12/12/2020 14:28	3,04	16	48,58	CHI
20201263540	GOIANIA	GN11001029	ATLANTICO S1	11/12/2020 18:44	11/12/2020 21:15	11/12/2020 18:44	11/12/2020 21:15	2,50	130	325,61	CHI
20201263339	GOIANIA	GN11002718	ATLANTICO S1	11/12/2020 18:47	11/12/2020 20:04	11/12/2020 18:47	11/12/2020 20:04	1,27	82	103,91	CHI
20201263300	GOIANIA	16552921	GOIANIA LESTE S3	11/12/2020 18:48	12/12/2020 02:25	11/12/2020 18:48	12/12/2020 02:25	7,61	1	7,61	CHI
20201263313	GOIANIA	15052278	GOYA S2	11/12/2020 18:51	11/12/2020 21:51	11/12/2020 18:51	11/12/2020 21:51	3,00	1	3,00	CHI
20201263315	ALTO PARAISO DE GOIAS	BF12302848	FLORES DE GOIAS	11/12/2020 18:51	11/12/2020 21:34	11/12/2020 18:51	11/12/2020 21:34	2,71	10	27,06	CHI
20201263320	PIRES DO RIO	460101870	PIRES DO RIO S1	11/12/2020 18:52	12/12/2020 01:22	11/12/2020 18:52	12/12/2020 01:22	6,49	1	6,49	CHI
20201263380	MORRINHOS	MR12307887	MORRINHOS	11/12/2020 18:54	11/12/2020 21:31	11/12/2020 18:54	11/12/2020 21:31	2,61	98	255,34	CHI
20201263325	SAO MIGUEL DO ARAGUAIA	SM12096368	NOVA CRIXAS	11/12/2020 18:55	13/12/2020 12:35	11/12/2020 18:55	12/12/2020 12:51	17,93	1	17,93	CHI
20201263325	SAO MIGUEL DO ARAGUAIA	SM12096368	NOVA CRIXAS	11/12/2020 18:55	13/12/2020 12:35	11/12/2020 18:55	13/12/2020 12:35	41,66	1	41,66	CHI
20201263326	AGUAS LINDAS DE GOIAS	4830221174	AGUAS LINDAS DE GOIAS S1	11/12/2020 18:55	11/12/2020 20:08	11/12/2020 18:55	11/12/2020 20:08	1,21	1	1,21	CHI
20201263331	PIRENOPOLIS	10015056846	CORUMBA	11/12/2020 18:55	11/12/2020 23:07	11/12/2020 18:55	11/12/2020 23:07	4,19	1	4,19	CHI
20201263335	AGUAS LINDAS DE GOIAS	10023231120	AGUAS LINDAS DE GOIAS S2	11/12/2020 18:56	11/12/2020 21:20	11/12/2020 18:56	11/12/2020 21:20	2,39	1	2,39	CHI
20201263410	FORMOSA	FA11129924	ITIQUEIRA	11/12/2020 18:57	11/12/2020 20:01	11/12/2020 18:57	11/12/2020 20:01	1,06	253	269,44	CHI
20201263655	GOIANIA	GN11291567	CAMPINAS S1	11/12/2020 18:59	11/12/2020 21:13	11/12/2020 18:59	11/12/2020 21:13	2,23	116	258,16	CHI
20201263353	FAZENDA NOVA	2290002453	IPORA	11/12/2020 19:00	12/12/2020 11:20	11/12/2020 19:00	12/12/2020 11:20	16,33	1	16,33	CHI
20201263361	SENADOR CANEDO	10013205046	SENADOR CANEDO	11/12/2020 19:02	11/12/2020 20:06	11/12/2020 19:02	11/12/2020 20:06	1,06	1	1,06	CHI
20201263362	SANTA HELENA DE GOIAS	SH21301265	ACREUNA	11/12/2020 19:02	11/12/2020 22:26	11/12/2020 19:02	11/12/2020 22:26	3,39	1	3,39	CHI
20201263366	ALTO PARAISO DE GOIAS	BF21228726	FLORES DE GOIAS	11/12/2020 19:02	11/12/2020 21:01	11/12/2020 19:02	11/12/2020 21:01	1,97	1	1,97	CHI
20201263370	RIO VERDE	10004732110	RIO VERDE S2	11/12/2020 19:03	12/12/2020 00:04	11/12/2020 19:03	12/12/2020 00:04	5,01	1	5,01	CHI
20201263519	MONTES CLAROS DE GOIAS	ME12038971	IPORA	11/12/2020 19:03	12/12/2020 10:07	11/12/2020 19:03	12/12/2020 10:07	15,06	4	60,22	CHI
20201263385	FAINA	GK12274573	ITAPURANGA	11/12/2020 19:07	11/12/2020 21:08	11/12/2020 19:07	11/12/2020 21:08	2,00	2	4,01	CHI
20201263389	MINEIROS	10006188964	PARQUE DAS EMAS	11/12/2020 19:09	12/12/2020 15:34	11/12/2020 19:09	12/12/2020 15:34	20,42	1	20,42	CHI
20201263392	APARECIDA DE GOIANIA	16707473	REAL S1	11/12/2020 19:10	11/12/2020 21:21	11/12/2020 19:10	11/12/2020 21:21	2,18	1	2,18	CHI
20201263393	PADRE BERNARDO	PB12284769	PADRE BERNARDO	11/12/2020 19:10	12/12/2020 00:33	11/12/2020 19:10	12/12/2020 00:33	5,38	69	371,14	CHI
20201263399	PARANAIGUARA	PC21193920	QUIRINOPOLIS	11/12/2020 19:11	11/12/2020 22:28	11/12/2020 19:11	11/12/2020 22:28	3,28	1	3,28	CHI
20201263402	GOIANIA	10001423329	REAL S2	11/12/2020 19:12	12/12/2020 00:27	11/12/2020 19:12	12/12/2020 00:27	5,24	1	5,24	CHI
20201263620	MONTIVIDIU	MV12030664	MONTIVIDIU T	11/12/2020 19:13	12/12/2020 00:09	11/12/2020 19:13	12/12/2020 00:09	4,93	14	68,97	CHI
20201263411	APARECIDA DE GOIANIA	14869676	REAL S1	11/12/2020 19:14	11/12/2020 22:32	11/12/2020 19:14	11/12/2020 22:32	3,29	1	3,29	CHI
20201263413	GOIANIA	12557420	MEIA PONTE	11/12/2020 19:14	11/12/2020 21:50	11/12/2020 19:14	11/12/2020 21:50	2,59	1	2,59	CHI
20201263414	SAO LUIS DE MONTES BELOS	SL21259964	FIRMINOPOLIS S2	11/12/2020 19:15	12/12/2020 15:12	11/12/2020 19:15	12/12/2020 15:12	19,95	1	19,95	CHI
20201263423	SENADOR CANEDO	10020731602	SENADOR CANEDO	11/12/2020 19:16	11/12/2020 20:08	11/12/2020 19:16	11/12/2020 20:08	0,85	1	0,85	CHI
20201263444	EDEIA	IY12010954	EDEIA	11/12/2020 19:16	11/12/2020 22:02	11/12/2020 19:16	11/12/2020 22:02	2,76	5	13,80	CHI
20201263444	INDIARA	IY12010954	EDEIA	11/12/2020 19:16	11/12/2020 22:02	11/12/2020 19:16	11/12/2020 22:02	2,76	46	126,92	CHI
20201263474	GOIANIA	GN11077779	REAL S1	11/12/2020 19:16	12/12/2020 00:04	11/12/2020 19:16	12/12/2020 00:04	4,80	61	292,68	CHI
20201263425	RIO VERDE	630590679	CABRIUVA S1	11/12/2020 19:17	12/12/2020 01:15	11/12/2020 19:17	12/12/2020 01:15	5,98	1	5,98	CHI
20201263779	COLINAS DO SUL	TI12355513	NIQUELANDIA SUBTRANSMISSAO	11/12/2020 19:17	12/12/2020 03:39	11/12/2020 19:17	12/12/2020 03:39	8,35	12	100,24	CHI
20201263440	BALIZA	BH12331400	CAIAPONIA	11/12/2020 19:19	12/12/2020 00:30	11/12/2020 19:19	12/12/2020 00:30	5,18	4	20,71	CHI
20201263461	APORE	IJ10401500	ITAJA S2	11/12/2020 19:20	11/12/2020 23:06	11/12/2020 19:20	11/12/2020 20:20	0,99	4	3,97	CHI
20201263461	ITAJA	IJ10401500	ITAJA S2	11/12/2020 19:20	11/12/2020 23:06	11/12/2020 19:20	11/12/2020 20:20	0,99	92	91,28	CHI
20201263461	ITARUMA	IJ10401500	ITAJA S2	11/12/2020 19:20	11/12/2020 23:06	11/12/2020 19:20	11/12/2020 20:20	0,99	1	0,99	CHI
20201263461	ITAJA	IM13082115	ITAJA S2	11/12/2020 19:20	11/12/2020 23:06	11/12/2020 19:20	11/12/2020 21:28	2,13	13	27,65	CHI
20201263461	ITARUMA	IM13082115	ITAJA S2	11/12/2020 19:20	11/12/2020 23:06	11/12/2020 19:20	11/12/2020 21:28	2,13	80	170,16	CHI
20201263461	ITARUMA	IM13303140	ITAJA S2	11/12/2020 19:20	11/12/2020 23:06	11/12/2020 19:20	11/12/2020 22:43	3,39	18	60,95	CHI

20201263461	ITARUMA	IM12205203LD	ITAJA S2	11/12/2020 19:20	11/12/2020 23:06	11/12/2020 19:20	11/12/2020 23:06	3,76	2	7,53	CHI
20201263912	DOVERLANDIA	CP12139786	CAIAPONIA	11/12/2020 19:20	12/12/2020 11:15	11/12/2020 19:20	12/12/2020 11:15	15,90	3	47,71	CHI
20201263912	CAIAPONIA	CP12139786	CAIAPONIA	11/12/2020 19:20	12/12/2020 11:15	11/12/2020 19:20	12/12/2020 11:15	15,90	12	190,82	CHI
20201263447	NOVA IGUACU DE GOIAS	NH12166555	SANTA TEREZINHA	11/12/2020 19:21	12/12/2020 00:18	11/12/2020 19:21	12/12/2020 00:18	4,94	2	9,88	CHI
20201263447	PILAR DE GOIAS	NH12166555	SANTA TEREZINHA	11/12/2020 19:21	12/12/2020 00:18	11/12/2020 19:21	12/12/2020 00:18	4,94	2	9,88	CHI
20201263450	JATAI	JT21324677	JATAI S2	11/12/2020 19:21	11/12/2020 21:20	11/12/2020 19:21	11/12/2020 21:20	1,97	1	1,97	CHI
20201263451	GOIANIA	12552756	GOYA S2	11/12/2020 19:22	12/12/2020 02:07	11/12/2020 19:22	12/12/2020 02:07	6,75	1	6,75	CHI
20201263453	SANCLERLANDIA	SC21361574	SAO LUIZ DOS MONTES BELOS	11/12/2020 19:22	12/12/2020 04:12	11/12/2020 19:22	12/12/2020 04:12	8,82	2	17,65	CHI
20201263455	CAIAPONIA	CP12404850	CAIAPONIA	11/12/2020 19:22	12/12/2020 11:40	11/12/2020 19:22	12/12/2020 11:40	16,29	6	97,72	CHI
20201263458	GOIATUBA	10008300087	GOIATUBA S2	11/12/2020 19:23	12/12/2020 10:13	11/12/2020 19:23	12/12/2020 10:13	14,83	1	14,83	CHI
20201263492	CACU	CC11194916	CACHOEIRA ALTA	11/12/2020 19:23	12/12/2020 00:21	11/12/2020 19:23	12/12/2020 00:21	4,95	132	653,73	CHI
20201263496	RIO VERDE	RV11213527	RIO VERDE S1	11/12/2020 19:23	11/12/2020 22:12	11/12/2020 19:23	11/12/2020 22:12	2,80	174	487,78	CHI
20201263464	ITAPACI	100035796	ITAPACI	11/12/2020 19:24	12/12/2020 08:26	11/12/2020 19:24	12/12/2020 08:26	13,03	1	13,03	CHI
202012179336	NOVO BRASIL	JUS-TR2	JUSSARA	11/12/2020 19:25	12/12/2020 00:25	11/12/2020 19:25	12/12/2020 00:25	5,00	12	60,04	CHI
202012179336	JUSSARA	JUS-TR2	JUSSARA	11/12/2020 19:25	12/12/2020 00:25	11/12/2020 19:25	12/12/2020 00:25	5,00	2368	11847,89	CHI
202012179336	ITAPIRAPUA	JUS-TR2	JUSSARA	11/12/2020 19:25	12/12/2020 00:25	11/12/2020 19:25	12/12/2020 00:25	5,00	169	845,56	CHI
202012179336	JUSSARA	JUS-TR2	JUSSARA	11/12/2020 19:25	12/12/2020 00:25	11/12/2020 19:25	12/12/2020 00:25	5,01	6127	30670,74	CHI
20201263541	PONTALINA	JV12208117	VICENTINOPOLIS	11/12/2020 19:26	11/12/2020 21:23	11/12/2020 19:26	11/12/2020 21:23	1,94	5	9,68	CHI
20201263478	CAIAPONIA	CP21259323	CAIAPONIA	11/12/2020 19:27	12/12/2020 10:18	11/12/2020 19:27	12/12/2020 10:18	14,84	1	14,84	CHI
20201264005	ANAPOLIS	AN21130772	JUNDIAI S2	11/12/2020 19:28	12/12/2020 00:35	11/12/2020 19:28	12/12/2020 00:35	5,11	64	327,02	CHI
20201263924	ITARUMA	IM12226622	CACHOEIRA ALTA	11/12/2020 19:29	12/12/2020 05:47	11/12/2020 19:29	12/12/2020 05:47	10,30	2	20,59	CHI
20201263562	JUSSARA	JR12396091	JUSSARA	11/12/2020 19:30	12/12/2020 02:50	11/12/2020 19:30	12/12/2020 02:50	7,32	9	65,88	CHI
20201263744	NOVA CRIXAS	NA12201789	NOVA CRIXAS	11/12/2020 19:30	12/12/2020 11:34	11/12/2020 19:30	12/12/2020 11:34	16,06	28	449,73	CHI
20201263506	EDEALINA	ED21366450	VICENTINOPOLIS	11/12/2020 19:31	11/12/2020 23:10	11/12/2020 19:31	11/12/2020 23:10	3,64	2	7,28	CHI
20201263524	SILVANIA	SV12172117	DAIA S2	11/12/2020 19:34	11/12/2020 23:17	11/12/2020 19:34	11/12/2020 23:17	3,71	170	631,17	CHI
20201263524	BELA VISTA DE GOIAS	SV12172117	DAIA S2	11/12/2020 19:34	11/12/2020 23:17	11/12/2020 19:34	11/12/2020 23:17	3,71	8	29,70	CHI
20201263534	PIRES DO RIO	10028477225	PIRES DO RIO S1	11/12/2020 19:35	11/12/2020 23:59	11/12/2020 19:35	11/12/2020 23:59	4,39	1	4,39	CHI
20201263546	PORANGATU	PO12048411	PORANGATU	11/12/2020 19:38	12/12/2020 10:50	11/12/2020 19:38	12/12/2020 05:00	9,36	6	56,17	CHI
20201263546	PORANGATU	PO12048411	PORANGATU	11/12/2020 19:38	12/12/2020 10:50	11/12/2020 19:38	12/12/2020 10:50	15,20	11	167,21	CHI
20201263600	GOIATUBA	GT12296905	GOIATUBA S2	11/12/2020 19:38	12/12/2020 11:10	11/12/2020 19:38	12/12/2020 11:03	15,43	6	92,56	CHI
20201263600	GOIATUBA	GT12296905	GOIATUBA S2	11/12/2020 19:38	12/12/2020 11:10	11/12/2020 19:38	12/12/2020 11:10	15,55	1	15,55	CHI
20201263553	ITABERAI	50060508	ITABERAI S2	11/12/2020 19:39	11/12/2020 21:54	11/12/2020 19:39	11/12/2020 21:54	2,25	1	2,25	CHI
20201264011	FORMOSA	FA12218264	ITUIQUIRA	11/12/2020 19:39	11/12/2020 23:50	11/12/2020 19:39	11/12/2020 23:50	4,17	88	367,35	CHI
20201264011	VILA BOA	FA12218264	ITUIQUIRA	11/12/2020 19:39	11/12/2020 23:50	11/12/2020 19:39	11/12/2020 23:50	4,17	4	16,70	CHI
20201263560	RUBIATABA	RB21242397	RUBIATABA	11/12/2020 19:41	11/12/2020 23:01	11/12/2020 19:41	11/12/2020 23:01	3,33	1	3,33	CHI
20201263612	SAO LUIS DE MONTES BELOS	SL10419312	SAO LUIZ DOS MONTES BELOS	11/12/2020 19:42	12/12/2020 13:37	11/12/2020 19:42	11/12/2020 19:52	0,16	349	56,13	CHI
20201263612	SAO LUIS DE MONTES BELOS	SL16418791	SAO LUIZ DOS MONTES BELOS	11/12/2020 19:42	12/12/2020 13:37	11/12/2020 19:42	11/12/2020 19:56	0,23	614	140,37	CHI
20201263612	SAO LUIS DE MONTES BELOS	SL16419303	SAO LUIZ DOS MONTES BELOS	11/12/2020 19:42	12/12/2020 13:37	11/12/2020 19:42	11/12/2020 19:57	0,24	414	99,47	CHI
20201263612	SAO LUIS DE MONTES BELOS	SL16419303	SAO LUIZ DOS MONTES BELOS	11/12/2020 19:42	12/12/2020 13:37	11/12/2020 19:54	11/12/2020 19:57	0,05	202	10,55	CHI
20201263612	SAO LUIS DE MONTES BELOS	SL16418878	SAO LUIZ DOS MONTES BELOS	11/12/2020 19:42	12/12/2020 13:37	11/12/2020 19:42	11/12/2020 20:37	0,92	670	613,24	CHI
20201263612	SAO LUIS DE MONTES BELOS	SL16418878	SAO LUIZ DOS MONTES BELOS	11/12/2020 19:42	12/12/2020 13:37	11/12/2020 19:42	11/12/2020 22:14	2,52	11	27,73	CHI
20201263612	SAO LUIS DE MONTES BELOS	SL16314930	SAO LUIZ DOS MONTES BELOS	11/12/2020 19:42	12/12/2020 13:37	11/12/2020 19:42	12/12/2020 04:07	8,40	28	235,25	CHI
20201263612	SAO LUIS DE MONTES BELOS	BJ24358290	SAO LUIZ DOS MONTES BELOS	11/12/2020 19:42	12/12/2020 13:37	11/12/2020 19:54	12/12/2020 04:07	8,21	90	739,25	CHI
20201263612	SAO LUIS DE MONTES BELOS	SL16314930	SAO LUIZ DOS MONTES BELOS	11/12/2020 19:42	12/12/2020 13:37	11/12/2020 19:42	12/12/2020 13:37	17,90	2	35,81	CHI
20201263659	VALPARAISO DE GOIAS	VA11041589	PACAEMBU S1	11/12/2020 19:42	11/12/2020 21:24	11/12/2020 19:42	11/12/2020 21:24	1,70	144	244,60	CHI
20201263578	AGUAS LINDAS DE GOIAS	4830168809	AGUAS LINDAS DE GOIAS S1	11/12/2020 19:46	11/12/2020 21:52	11/12/2020 19:46	11/12/2020 21:52	2,09	1	2,09	CHI
20201263580	DISTRITO FEDERAL	10014134592	MARAJOARA	11/12/2020 19:46	11/12/2020 21:00	11/12/2020 19:46	11/12/2020 21:00	1,22	1	1,22	CHI
20201263615	GOIANIA	GN11142838	GOYA S2	11/12/2020 19:46	11/12/2020 21:51	11/12/2020 19:46	11/12/2020 21:51	2,07	195	404,14	CHI
20201263703	CALDAS NOVAS	8065347	SERRA DE CALDAS	11/12/2020 19:47	11/12/2020 22:50	11/12/2020 19:47	11/12/2020 22:21	2,58	38	97,95	CHI
20201263703	CALDAS NOVAS	CN11363681	SERRA DE CALDAS	11/12/2020 19:47	11/12/2020 22:50	11/12/2020 19:47	11/12/2020 22:33	2,77	45	124,79	CHI
20201263703	CALDAS NOVAS	CN11363679	SERRA DE CALDAS	11/12/2020 19:47	11/12/2020 22:50	11/12/2020 19:47	11/12/2020 22:50	3,06	43	131,53	CHI

20201263763	APARECIDA DE GOIANIA	AP11169621	ATLANTICO S3	11/12/2020 19:48	11/12/2020 21:35	11/12/2020 19:48	11/12/2020 21:35	1,78	72	128,18	CHI
20201263604	APARECIDA DE GOIANIA	10019289250	INDEPENDENCIA S2	11/12/2020 19:49	12/12/2020 04:42	11/12/2020 19:49	12/12/2020 04:42	8,88	1	8,88	CHI
20201263610	INACIOLANDIA	ID11305467	CACHOEIRA DOURADA	11/12/2020 19:49	11/12/2020 21:10	11/12/2020 19:49	11/12/2020 21:10	1,34	1	1,34	CHI
20201263614	FORMOSA	FA21218703	ITUIQUIRA	11/12/2020 19:49	12/12/2020 10:32	11/12/2020 19:49	12/12/2020 10:32	14,70	1	14,70	CHI
20201263632	NIQUELANDIA	NQ11057939	NIQUELANDIA SUBTRANSMISSAO	11/12/2020 19:52	12/12/2020 00:03	11/12/2020 19:52	12/12/2020 00:03	4,18	178	744,19	CHI
20201263636	APARECIDA DE GOIANIA	10032799690	INDEPENDENCIA S2	11/12/2020 19:52	11/12/2020 22:34	11/12/2020 19:52	11/12/2020 22:34	2,69	1	2,69	CHI
20201263640	CRIXAS	CX21309317	SERRA DO OURO	11/12/2020 19:53	12/12/2020 11:00	11/12/2020 19:53	12/12/2020 11:00	15,10	1	15,10	CHI
20201263647	SAO MIGUEL DO ARAGUAIA	SM12220658	SAO MIGUEL DO ARAGUAIA	11/12/2020 19:56	12/12/2020 13:41	11/12/2020 19:56	12/12/2020 13:41	17,75	4	70,98	CHI
20201263651	APARECIDA DE GOIANIA	200260649	INDEPENDENCIA S1	11/12/2020 19:57	11/12/2020 21:42	11/12/2020 19:57	11/12/2020 21:42	1,76	1	1,76	CHI
20201263652	VALPARAISO DE GOIAS	VA12381888	MARAJOARA	11/12/2020 19:57	11/12/2020 22:03	11/12/2020 19:57	11/12/2020 22:03	2,09	632	1321,93	CHI
20201264009	APARECIDA DE GOIANIA	200260649	INDEPENDENCIA S1	11/12/2020 19:57	12/12/2020 00:34	11/12/2020 19:57	12/12/2020 00:34	4,61	1	4,61	CHI
20201263658	PIRACANJUBA	PJ12038648	PIRACANJUBA	11/12/2020 19:58	12/12/2020 12:44	11/12/2020 19:58	12/12/2020 12:44	16,76	2	33,52	CHI
20201263861	JUSSARA	JR12008743	BRITANIA	11/12/2020 19:58	12/12/2020 07:40	11/12/2020 19:58	12/12/2020 07:40	11,70	38	444,60	CHI
20201263671	CRISTALINA	KR12163117	CRISTALINA S1	11/12/2020 20:01	11/12/2020 23:45	11/12/2020 20:01	11/12/2020 23:45	3,73	7	26,11	CHI
20201263702	ANAPOLIS	AN11130801	JUNDIAI S2	11/12/2020 20:01	11/12/2020 21:50	11/12/2020 20:01	11/12/2020 21:50	1,82	126	229,88	CHI
20201263677	PILAR DE GOIAS	GG21141542	URUACU	11/12/2020 20:02	11/12/2020 22:11	11/12/2020 20:02	11/12/2020 22:11	2,15	1	2,15	CHI
20201263679	TRINDADE	40098631	TRINDADE	11/12/2020 20:02	11/12/2020 23:19	11/12/2020 20:02	11/12/2020 23:19	3,28	1	3,28	CHI
20201263694	ITUMBIARA	10025027415	ITUMBIARA VELHA S1	11/12/2020 20:05	11/12/2020 23:39	11/12/2020 20:05	11/12/2020 23:39	3,56	1	3,56	CHI
20201263699	PILAR DE GOIAS	GG21212336	SANTA TEREZINHA	11/12/2020 20:07	12/12/2020 02:00	11/12/2020 20:07	12/12/2020 02:00	5,87	1	5,87	CHI
20201263706	GOIANIA	12544140	CAMPINAS S1	11/12/2020 20:08	11/12/2020 23:31	11/12/2020 20:08	11/12/2020 23:31	3,37	1	3,37	CHI
20201263863	ESTRELA DO NORTE	MU12076698	MARA ROSA	11/12/2020 20:09	12/12/2020 10:03	11/12/2020 20:09	12/12/2020 10:03	13,90	1	13,90	CHI
20201263863	MUTUNOPOLIS	MU12076698	MARA ROSA	11/12/2020 20:09	12/12/2020 10:03	11/12/2020 20:09	12/12/2020 10:03	13,90	31	430,77	CHI
20201263748	FORMOSA	FA12204778	ITUIQUIRA	11/12/2020 20:10	11/12/2020 22:44	11/12/2020 20:10	11/12/2020 22:44	2,56	19	48,69	CHI
20201264106	PADRE BERNARDO	PB12275452	PADRE BERNARDO	11/12/2020 20:11	12/12/2020 02:59	11/12/2020 20:11	12/12/2020 02:59	6,79	28	190,24	CHI
20201263717	AGUAS LINDAS DE GOIAS	10010621685	AGUAS LINDAS DE GOIAS S1	11/12/2020 20:12	12/12/2020 01:06	11/12/2020 20:12	12/12/2020 01:06	4,90	1	4,90	CHI
20201263720	AGUAS LINDAS DE GOIAS	10008732912	AGUAS LINDAS DE GOIAS S1	11/12/2020 20:13	11/12/2020 21:39	11/12/2020 20:13	11/12/2020 21:39	1,43	1	1,43	CHI
20201263722	CALDAS NOVAS	760258960	SERRA DE CALDAS	11/12/2020 20:14	11/12/2020 23:36	11/12/2020 20:14	11/12/2020 23:36	3,36	1	3,36	CHI
20201263723	CATALAO	CT12428083	CATALAO S1	11/12/2020 20:14	12/12/2020 08:41	11/12/2020 20:14	12/12/2020 08:41	12,44	2	24,88	CHI
20201263828	ANAPOLIS	AN11258178	ANAPOLIS UNIVERSITARIO S2	11/12/2020 20:18	11/12/2020 21:20	11/12/2020 20:18	11/12/2020 21:20	1,03	89	91,37	CHI
20201263733	GOIANIA	13896842	GOYA S2	11/12/2020 20:20	11/12/2020 22:45	11/12/2020 20:20	11/12/2020 22:45	2,41	1	2,41	CHI
20201263835	ANAPOLIS	AN11210796	JUNDIAI S1	11/12/2020 20:20	11/12/2020 22:49	11/12/2020 20:20	11/12/2020 22:49	2,47	125	308,61	CHI
20201263738	GOIANIA	12133255	AEROPORTO S1	11/12/2020 20:22	11/12/2020 23:28	11/12/2020 20:22	11/12/2020 23:28	3,10	1	3,10	CHI
20201263740	PIRENOPOLIS	220009259	CORUMBA	11/12/2020 20:23	12/12/2020 10:12	11/12/2020 20:23	12/12/2020 10:12	13,81	1	13,81	CHI
20201263745	TRINDADE	40054172	GOYA S1	11/12/2020 20:24	12/12/2020 00:58	11/12/2020 20:24	12/12/2020 00:58	4,56	1	4,56	CHI
20201263747	FORMOSA	FA21156107	SAO JOAO D ALIANCA	11/12/2020 20:24	11/12/2020 21:25	11/12/2020 20:24	11/12/2020 21:25	1,02	1	1,02	CHI
20201263805	SENADOR CANEDO	SW11092634	SENADOR CANEDO	11/12/2020 20:27	12/12/2020 02:00	11/12/2020 20:27	12/12/2020 02:00	5,54	198	1097,08	CHI
20201263767	GOIANIA	15816412	GOYA S2	11/12/2020 20:29	12/12/2020 00:50	11/12/2020 20:29	12/12/2020 00:50	4,34	1	4,34	CHI
20201263869	ANAPOLIS	AN11258140	ANAPOLIS UNIVERSITARIO S2	11/12/2020 20:30	11/12/2020 21:47	11/12/2020 20:30	11/12/2020 21:47	1,28	104	133,38	CHI
20201263773	CATURAI	CK21017184	INHUMAS S1	11/12/2020 20:31	12/12/2020 01:00	11/12/2020 20:31	12/12/2020 01:00	4,47	1	4,47	CHI
20201263784	VALPARAISO DE GOIAS	VA11169042	MARAJOARA	11/12/2020 20:31	11/12/2020 21:58	11/12/2020 20:31	11/12/2020 21:58	1,44	190	273,18	CHI
20201263778	PIRENOPOLIS	PV12062894	SAO FRANCISCO DE GOIAS	11/12/2020 20:32	12/12/2020 09:49	11/12/2020 20:32	12/12/2020 09:49	13,27	22	292,03	CHI
20201263778	PETROLINA DE GOIAS	PV12062894	SAO FRANCISCO DE GOIAS	11/12/2020 20:32	12/12/2020 09:49	11/12/2020 20:32	12/12/2020 09:49	13,27	3	39,82	CHI
20201263780	COCALZINHO DE GOIAS	LA12275354	AGUAS LINDAS DE GOIAS S2	11/12/2020 20:33	12/12/2020 08:04	11/12/2020 20:33	12/12/2020 08:04	11,51	2	23,02	CHI
20201267027	SAO JOAO D ALIANCA	JL12049201	SAO JOAO D ALIANCA	11/12/2020 20:35	12/12/2020 20:34	11/12/2020 20:35	12/12/2020 20:34	23,97	95	2276,97	CHI
20201263798	PORANGATU	PO12348288	PORANGATU	11/12/2020 20:38	12/12/2020 04:09	11/12/2020 20:38	12/12/2020 04:09	7,51	8	60,04	CHI
20201263823	ITAPURANGA	IK12187039	ITAPURANGA	11/12/2020 20:38	12/12/2020 00:27	11/12/2020 20:38	12/12/2020 00:27	3,81	21	80,05	CHI
20201263804	ARAGARCAS	AG12380911	ARAGARCAS	11/12/2020 20:40	12/12/2020 09:09	11/12/2020 20:40	12/12/2020 09:09	12,48	1	12,48	CHI
20201263817	NOVA CRIXAS	8570010920	NOVA CRIXAS	11/12/2020 20:46	11/12/2020 23:44	11/12/2020 20:46	11/12/2020 23:44	2,96	1	2,96	CHI
20201263826	LEOPOLDO DE BULHOES	LB12351258	DAIA S2	11/12/2020 20:46	11/12/2020 22:29	11/12/2020 20:46	11/12/2020 22:29	1,71	9	15,39	CHI
20201263818	SILVANIA	SV21282363	VIANOPOLIS	11/12/2020 20:47	11/12/2020 23:37	11/12/2020 20:47	11/12/2020 23:37	2,83	1	2,83	CHI
20201263819	VIANOPOLIS	1490011940	CRISTIANOPOLIS	11/12/2020 20:47	12/12/2020 02:44	11/12/2020 20:47	12/12/2020 02:44	5,94	1	5,94	CHI

20201263820	CORUMBA DE GOIAS	CB21335629	CORUMBA	11/12/2020 20:47	12/12/2020 07:47	11/12/2020 20:47	12/12/2020 07:47	10,98	2	21,97	CHI
20201264461	AGUA FRIA DE GOIAS	NQ12270128RE	SAO JOAO D ALIANCA	11/12/2020 20:48	12/12/2020 13:19	11/12/2020 20:48	12/12/2020 13:19	16,51	70	1155,76	CHI
20201264461	NIQUELANDIA	NQ12270128RE	SAO JOAO D ALIANCA	11/12/2020 20:48	12/12/2020 13:19	11/12/2020 20:48	12/12/2020 13:19	16,51	17	280,68	CHI
20201263829	ITAPIRAPUA	IU12142823	MATRINCHA	11/12/2020 20:50	12/12/2020 08:15	11/12/2020 20:50	12/12/2020 08:15	11,40	3	34,21	CHI
20201263842	GOIANIA	16879867	GOYA S1	11/12/2020 20:57	12/12/2020 05:16	11/12/2020 20:57	12/12/2020 05:16	8,31	1	8,31	CHI
20201263846	GOIANIA	16264800	MEIA PONTE	11/12/2020 20:59	12/12/2020 01:34	11/12/2020 20:59	12/12/2020 01:34	4,58	1	4,58	CHI
20201263848	PORANGATU	PO12000010	PORANGATU	11/12/2020 20:59	12/12/2020 09:22	11/12/2020 20:59	12/12/2020 09:22	12,37	5	61,84	CHI
20201263850	LUZIANIA	LZ11162755	MARAJOARA	11/12/2020 21:00	11/12/2020 23:36	11/12/2020 21:00	11/12/2020 23:36	2,60	196	509,33	CHI
20201263860	NOVA AMERICA	NM21187161	RUBIATABA	11/12/2020 21:02	12/12/2020 14:19	11/12/2020 21:02	12/12/2020 14:19	17,27	1	17,27	CHI
20201263862	CRISTALINA	KR21330696	CRISTALINA S2	11/12/2020 21:03	12/12/2020 01:00	11/12/2020 21:03	12/12/2020 01:00	3,95	1	3,95	CHI
20201263874	ITABERAI	IB12206921	ITABERAI S2	11/12/2020 21:07	12/12/2020 08:11	11/12/2020 21:07	12/12/2020 08:11	11,06	4	44,25	CHI
20201263897	CRISTALINA	KR10406652	CRISTALINA S1	11/12/2020 21:11	12/12/2020 09:34	11/12/2020 21:11	12/12/2020 08:18	11,11	14	155,59	CHI
20201263897	CRISTALINA	KR12373404LD	CRISTALINA S1	11/12/2020 21:11	12/12/2020 09:34	11/12/2020 21:11	12/12/2020 09:20	12,15	94	1141,97	CHI
20201263897	CRISTALINA	KR12370868LD	CRISTALINA S1	11/12/2020 21:11	12/12/2020 09:34	11/12/2020 21:11	12/12/2020 09:34	12,39	5	61,95	CHI
20201263884	GOIANIA	16610155	SENADOR CANEDO	11/12/2020 21:12	12/12/2020 02:45	11/12/2020 21:12	12/12/2020 02:45	5,54	1	5,54	CHI
20201263910	COCALZINHO DE GOIAS	CB12043409	COCALZINHO	11/12/2020 21:12	11/12/2020 23:16	11/12/2020 21:12	11/12/2020 23:16	2,05	20	41,02	CHI
20201263889	ANAPOLIS	AN21265113	NEROPOLIS S1	11/12/2020 21:13	11/12/2020 22:36	11/12/2020 21:13	11/12/2020 22:36	1,37	2	2,74	CHI
20201263951	RIO VERDE	RV12135950	CABRIUVA S2	11/12/2020 21:13	12/12/2020 00:49	11/12/2020 21:13	12/12/2020 00:49	3,60	20	71,90	CHI
20201263890	NOVO GAMA	2460071389	PACAEMBU S1	11/12/2020 21:15	11/12/2020 23:41	11/12/2020 21:15	11/12/2020 23:41	2,43	1	2,43	CHI
20201263901	TRINDADE	10009087417	TRINDADE	11/12/2020 21:21	12/12/2020 01:40	11/12/2020 21:21	12/12/2020 01:40	4,31	1	4,31	CHI
20201263911	NIQUELANDIA	NQ21317641	BARRO ALTO	11/12/2020 21:23	12/12/2020 08:12	11/12/2020 21:23	12/12/2020 08:12	10,81	1	10,81	CHI
20201263915	FORMOSA	FA12202274	ITUIQUIRA	11/12/2020 21:25	12/12/2020 09:10	11/12/2020 21:25	12/12/2020 09:10	11,74	5	58,70	CHI
20201264073	PORANGATU	TA12114216	NOVO PLANALTO	11/12/2020 21:25	12/12/2020 04:11	11/12/2020 21:25	12/12/2020 04:11	6,76	6	40,58	CHI
20201263943	APARECIDA DE GOIANIA	AP11251770	INDEPENDENCIA S1	11/12/2020 21:31	12/12/2020 02:34	11/12/2020 21:31	12/12/2020 02:34	5,04	58	292,59	CHI
20201263936	ABADIANIA	AA12414271	ANAPOLIS UNIVERSITARIO S1	11/12/2020 21:34	13/12/2020 03:30	11/12/2020 21:34	13/12/2020 03:30	29,94	3	89,81	CHI
20201263938	CAIAPONIA	CP12200875	CAIAPONIA	11/12/2020 21:34	12/12/2020 08:04	11/12/2020 21:34	12/12/2020 08:04	10,48	9	94,36	CHI
20201263942	CHAPADAO DO CEU	9880017012	CHAPADAO DO CEU	11/12/2020 21:36	12/12/2020 08:11	11/12/2020 21:36	12/12/2020 08:11	10,57	1	10,57	CHI
20201263947	ARAGUAPAZ	AZ11328953	MOZARLANDIA	11/12/2020 21:41	12/12/2020 08:21	11/12/2020 21:41	12/12/2020 08:21	10,66	1	10,66	CHI
20201264002	MATRINCHA	MP12010442	MOZARLANDIA	11/12/2020 21:41	12/12/2020 02:18	11/12/2020 21:41	12/12/2020 02:18	4,61	4	18,42	CHI
20201263954	GOIANIA	10006518867	CARAJAS S2	11/12/2020 21:46	11/12/2020 23:53	11/12/2020 21:46	11/12/2020 23:53	2,11	1	2,11	CHI
20201263956	VICENTINOPOLIS	VI21218159	VICENTINOPOLIS	11/12/2020 21:48	11/12/2020 23:27	11/12/2020 21:48	11/12/2020 23:27	1,65	2	3,30	CHI
20201263957	CACHOEIRA ALTA	CA12137760	CACHOEIRA ALTA	11/12/2020 21:48	12/12/2020 11:33	11/12/2020 21:48	12/12/2020 11:33	13,75	10	137,46	CHI
20201263960	JANDAIA	JD21328166	PALMEIRAS	11/12/2020 21:48	13/12/2020 12:35	11/12/2020 21:48	13/12/2020 12:35	38,79	1	38,79	CHI
20201264094	PIRES DO RIO	PR12000096RE	PIRES DO RIO S1	11/12/2020 21:48	12/12/2020 07:32	11/12/2020 21:48	12/12/2020 07:32	9,73	22	214,03	CHI
20201264094	PALMELO	PR12000096RE	PIRES DO RIO S1	11/12/2020 21:48	12/12/2020 07:32	11/12/2020 21:48	12/12/2020 07:32	9,73	6	58,37	CHI
20201263961	QUIRINOPOLIS	QI12326641	QUIRINOPOLIS	11/12/2020 21:49	12/12/2020 00:57	11/12/2020 21:49	12/12/2020 00:57	3,13	2	6,27	CHI
20201263962	ITABERAI	IB12021840	ITABERAI S2	11/12/2020 21:49	12/12/2020 03:50	11/12/2020 21:49	12/12/2020 03:50	6,00	12	72,03	CHI
20201263967	ANAPOLIS	10014410387	ANAPOLIS UNIVERSITARIO S1	11/12/2020 21:53	11/12/2020 23:51	11/12/2020 21:53	11/12/2020 23:51	1,96	1	1,96	CHI
20201263970	CALDAS NOVAS	10028018697	SERRA DE CALDAS	11/12/2020 21:54	11/12/2020 23:52	11/12/2020 21:54	11/12/2020 23:52	1,96	1	1,96	CHI
20201263974	CACHOEIRA ALTA	CA21094402	CACHOEIRA ALTA	11/12/2020 21:58	12/12/2020 10:36	11/12/2020 21:58	12/12/2020 10:36	12,62	1	12,62	CHI
20201263977	AGUAS LINDAS DE GOIAS	4830080931	AGUAS LINDAS DE GOIAS S1	11/12/2020 22:00	12/12/2020 02:12	11/12/2020 22:00	12/12/2020 02:12	4,20	1	4,20	CHI
20201263979	ABADIA DE GOIAS	TR31048077	GUAPO S1	11/12/2020 22:01	12/12/2020 01:16	11/12/2020 22:01	12/12/2020 01:16	3,24	1	3,24	CHI
20201264378	GOIAS	GS12206865	MATRINCHA	11/12/2020 22:01	12/12/2020 09:17	11/12/2020 22:01	12/12/2020 09:17	11,26	68	765,53	CHI
20201263982	VALPARAISO DE GOIAS	10027235716	MARAJOARA	11/12/2020 22:06	12/12/2020 02:01	11/12/2020 22:06	12/12/2020 02:01	3,91	1	3,91	CHI
20201264835	SANTA FE DE GOIAS	RN12391528	BRITANIA	11/12/2020 22:07	12/12/2020 19:16	11/12/2020 22:07	12/12/2020 19:16	21,14	6	126,86	CHI
20201263991	GOIAS	GS21027673	MATRINCHA	11/12/2020 22:12	12/12/2020 07:36	11/12/2020 22:12	12/12/2020 07:36	9,39	1	9,39	CHI
20201264337	ANAPOLIS	OV12115764	NEROPOLIS S1	11/12/2020 22:15	12/12/2020 10:02	11/12/2020 22:15	12/12/2020 10:02	11,78	8	94,25	CHI
20201264337	PETROLINA DE GOIAS	OV12115764	NEROPOLIS S1	11/12/2020 22:15	12/12/2020 10:02	11/12/2020 22:15	12/12/2020 10:02	11,78	9	106,03	CHI
20201264337	PIRENOPOLIS	OV12115764	NEROPOLIS S1	11/12/2020 22:15	12/12/2020 10:02	11/12/2020 22:15	12/12/2020 10:02	11,78	29	341,65	CHI
20201264007	DIVINOPOLIS DE GOIAS	2570008728	SAO DOMINGOS	11/12/2020 22:18	11/12/2020 23:37	11/12/2020 22:18	11/12/2020 23:37	1,30	1	1,30	CHI
20201264010	ANAPOLIS	AN21258254	ANAPOLIS UNIVERSITARIO S2	11/12/2020 22:22	11/12/2020 23:29	11/12/2020 22:22	11/12/2020 23:29	1,11	1	1,11	CHI

20201264086	PIRACANJUBA	PJ12182740	PIRACANJUBA	11/12/2020 22:23	12/12/2020 00:34	11/12/2020 22:23	12/12/2020 00:34	2,18	14	30,54	CHI
20201264020	PADRE BERNARDO	PB12377203	PADRE BERNARDO	11/12/2020 22:28	12/12/2020 04:25	11/12/2020 22:28	12/12/2020 04:25	5,94	14	83,11	CHI
20201264946	GOIAS	GS12188036	GOIAS	11/12/2020 22:31	12/12/2020 11:39	11/12/2020 22:31	12/12/2020 11:39	13,13	38	498,98	CHI
20201264024	NAZARIO	NZ12299190	ANICUNS	11/12/2020 22:32	12/12/2020 10:05	11/12/2020 22:32	12/12/2020 10:05	11,55	8	92,38	CHI
20201264026	VILA BOA	2880000574	IACIARA S2	11/12/2020 22:33	12/12/2020 07:27	11/12/2020 22:33	12/12/2020 07:27	8,89	1	8,89	CHI
20201264029	CRISTALINA	KR21165892	CRISTALINA S2	11/12/2020 22:37	12/12/2020 12:18	11/12/2020 22:37	12/12/2020 12:18	13,67	1	13,67	CHI
20201264035	MORRINHOS	MR12399813	MORRINHOS	11/12/2020 22:44	12/12/2020 07:00	11/12/2020 22:44	12/12/2020 07:00	8,27	19	157,04	CHI
20201264053	PALMEIRAS DE GOIAS	PP12233536	PALMEIRAS	11/12/2020 22:48	12/12/2020 09:38	11/12/2020 22:48	12/12/2020 09:38	10,83	10	108,33	CHI
20201264053	PALMINOPOLIS	PP12233536	PALMEIRAS	11/12/2020 22:48	12/12/2020 09:38	11/12/2020 22:48	12/12/2020 09:38	10,83	1	10,83	CHI
20201264333	EDEIA	IY12010954	EDEIA	11/12/2020 22:49	12/12/2020 07:34	11/12/2020 22:49	12/12/2020 07:34	8,74	5	43,72	CHI
20201264333	INDIARA	IY12010954	EDEIA	11/12/2020 22:49	12/12/2020 07:34	11/12/2020 22:49	12/12/2020 07:34	8,74	46	402,18	CHI
20201264057	GOIANIA	10013857434	MEIA PONTE	11/12/2020 22:50	12/12/2020 03:52	11/12/2020 22:50	12/12/2020 03:52	5,03	1	5,03	CHI
20201264061	TURVANIA	NZ12382571	ANICUNS	11/12/2020 22:52	12/12/2020 05:11	11/12/2020 22:52	12/12/2020 05:11	6,30	14	88,27	CHI
20201264061	NAZARIO	NZ12382571	ANICUNS	11/12/2020 22:52	12/12/2020 05:11	11/12/2020 22:52	12/12/2020 05:11	6,30	29	182,84	CHI
20201264101	SAO MIGUEL DO ARAGUAIA	SM12013236	SAO MIGUEL DO ARAGUAIA	11/12/2020 22:52	12/12/2020 09:22	11/12/2020 22:52	12/12/2020 09:22	10,50	11	115,48	CHI
20201264083	SANTA ROSA DE GOIAS	IX12013157	INHUMAS S2	11/12/2020 22:55	12/12/2020 01:21	11/12/2020 22:55	12/12/2020 01:21	2,42	11	26,60	CHI
20201264083	ITAUCU	IX12013157	INHUMAS S2	11/12/2020 22:55	12/12/2020 01:21	11/12/2020 22:55	12/12/2020 01:21	2,42	5	12,09	CHI
20201264067	GOIANIA	GN11001167	CAMPINAS S1	11/12/2020 22:59	12/12/2020 02:39	11/12/2020 22:59	12/12/2020 02:39	3,65	94	343,23	CHI
20201264587	MINACU	IH12230480	MINACU	11/12/2020 23:02	12/12/2020 19:09	11/12/2020 23:02	12/12/2020 19:09	20,11	17	341,85	CHI
20201264075	SANTA HELENA DE GOIAS	SH21159373	IPEGUARI	11/12/2020 23:04	12/12/2020 03:23	11/12/2020 23:04	12/12/2020 03:23	4,30	4	17,22	CHI
20201264085	MOSSAMEDES	MD21336456	ITABERAI S2	11/12/2020 23:17	12/12/2020 01:02	11/12/2020 23:17	12/12/2020 01:02	1,75	1	1,75	CHI
20201264087	GUARANI DE GOIAS	GY12271764	IACIARA S1	11/12/2020 23:21	12/12/2020 01:20	11/12/2020 23:21	12/12/2020 01:20	1,97	4	7,87	CHI
20201264089	APARECIDA DE GOIANIA	16713023	REAL S1	11/12/2020 23:24	12/12/2020 00:44	11/12/2020 23:24	12/12/2020 00:44	1,32	1	1,32	CHI
20201264092	VARJAO	GA21235827	GUAPO S2	11/12/2020 23:27	12/12/2020 00:45	11/12/2020 23:27	12/12/2020 00:45	1,29	1	1,29	CHI
20201264096	JATAI	JT21419977	JATAI S1	11/12/2020 23:33	12/12/2020 09:25	11/12/2020 23:33	12/12/2020 09:25	9,85	1	9,85	CHI
20201264103	SAO MIGUEL DO PASSA QUATRO	SQ32097884	BELA VISTA S2	11/12/2020 23:44	12/12/2020 03:10	11/12/2020 23:44	12/12/2020 03:10	3,43	15	51,45	CHI
20201264202	PIRENOPOLIS	PV12384891	CORUMBA	11/12/2020 23:52	12/12/2020 10:49	11/12/2020 23:52	12/12/2020 10:49	10,95	15	164,20	CHI
20201264180	NOVA CRIXAS	NA12391603	NOVA CRIXAS	11/12/2020 23:55	12/12/2020 09:01	11/12/2020 23:55	12/12/2020 09:01	9,10	40	363,96	CHI
20201264112	CORREGO DO OURO	CO21400912	FIRMINOPOLIS S2	11/12/2020 23:56	12/12/2020 02:41	11/12/2020 23:56	12/12/2020 02:41	2,75	1	2,75	CHI
20201264113	GOIANIA	16389906	GOYA S2	11/12/2020 23:56	12/12/2020 04:34	11/12/2020 23:56	12/12/2020 04:34	4,62	1	4,62	CHI
20201264115	HIDROLANDIA	HD12320422	CEPAIGO S1	12/12/2020 00:01	12/12/2020 01:43	12/12/2020 00:01	12/12/2020 01:43	1,69	13	21,99	CHI
20201265072	EDEIA	EA12257973	EDEIA	12/12/2020 00:02	12/12/2020 10:36	12/12/2020 00:02	12/12/2020 10:36	10,56	33	348,44	CHI
20201265072	INDIARA	EA12257973	EDEIA	12/12/2020 00:02	12/12/2020 10:36	12/12/2020 00:02	12/12/2020 10:36	10,56	7	73,91	CHI
20201265072	ACREUNA	EA12257973	EDEIA	12/12/2020 00:02	12/12/2020 10:36	12/12/2020 00:02	12/12/2020 10:36	10,56	13	137,27	CHI
20201265147	CROMINIA	CQ12000304RE	PONTALINA	12/12/2020 00:04	12/12/2020 11:46	12/12/2020 00:04	12/12/2020 11:46	11,69	25	292,21	CHI
20201265040	COCALZINHO DE GOIAS	19798530	COCALZINHO	12/12/2020 00:34	12/12/2020 12:06	12/12/2020 00:34	12/12/2020 12:06	11,52	16	184,34	CHI
20201264603	ITAGUARI	IC12036612	ITABERAI S1	12/12/2020 00:49	12/12/2020 11:13	12/12/2020 00:49	12/12/2020 11:13	10,39	16	166,19	CHI
20201264603	JARAGUA	IC12036612	ITABERAI S1	12/12/2020 00:49	12/12/2020 11:13	12/12/2020 00:49	12/12/2020 11:13	10,39	96	997,12	CHI
20201264603	ITAGUARU	IC12036612	ITABERAI S1	12/12/2020 00:49	12/12/2020 11:13	12/12/2020 00:49	12/12/2020 11:13	10,39	21	218,12	CHI
20201264550	CAIAPONIA	PY12244702	PALESTINA	12/12/2020 01:02	12/12/2020 10:25	12/12/2020 01:02	12/12/2020 10:25	9,38	48	450,35	CHI
20201264550	PALESTINA DE GOIAS	PY12244702	PALESTINA	12/12/2020 01:02	12/12/2020 10:25	12/12/2020 01:02	12/12/2020 10:25	9,38	2	18,76	CHI
20201264151	QUIRINOPOLIS	QI32052465	SANTA HELENA S1	12/12/2020 01:21	12/12/2020 13:42	12/12/2020 01:21	12/12/2020 13:42	12,35	6	74,10	CHI
20201264152	LUZIANIA	KR12080375	PAMPLONA	12/12/2020 01:22	12/12/2020 07:38	12/12/2020 01:22	12/12/2020 07:38	6,26	1	6,26	CHI
20201264154	ORIZONA	OZ21248900	PIRES DO RIO S2	12/12/2020 01:31	12/12/2020 09:55	12/12/2020 01:31	12/12/2020 09:55	8,40	1	8,40	CHI
20201264155	INHUMAS	IN12346355	ARACU	12/12/2020 01:36	12/12/2020 04:14	12/12/2020 01:36	12/12/2020 04:14	2,63	4	10,53	CHI
20201264156	GOIANIA	GN11139595	REAL S1	12/12/2020 01:38	12/12/2020 04:35	12/12/2020 01:38	12/12/2020 04:35	2,94	224	659,31	CHI
20201264157	TRINDADE	TR21165739	TRINDADE	12/12/2020 01:43	12/12/2020 02:58	12/12/2020 01:43	12/12/2020 02:58	1,24	1	1,24	CHI
20201264159	ACREUNA	EU12075087	ACREUNA	12/12/2020 01:47	12/12/2020 04:37	12/12/2020 01:47	12/12/2020 04:37	2,83	11	31,12	CHI
20201264914	ITAPIRAPUA	IU12020119	MATRINCHA	12/12/2020 01:50	12/12/2020 10:06	12/12/2020 01:50	12/12/2020 10:06	8,25	42	346,70	CHI
20201264914	BRITANIA	IU12020119	MATRINCHA	12/12/2020 01:50	12/12/2020 10:06	12/12/2020 01:50	12/12/2020 10:06	8,25	6	49,53	CHI
20201264165	SANTO ANTONIO DO DESCOBERTO	2210059982	AGUAS LINDAS DE GOIAS S2	12/12/2020 02:02	12/12/2020 05:24	12/12/2020 02:02	12/12/2020 05:24	3,38	1	3,38	CHI

20201264876	JATAI	JT11348512	JATAI S3	12/12/2020 02:02	12/12/2020 08:59	12/12/2020 02:02	12/12/2020 08:59	6,93	40	277,36	CHI
20201264167	CAIAPONIA	PW12374317RE	PARQUE DAS EMAS	12/12/2020 02:13	12/12/2020 05:09	12/12/2020 02:13	12/12/2020 05:09	2,93	1	2,93	CHI
20201264167	PORTELANDIA	PW12374317RE	PARQUE DAS EMAS	12/12/2020 02:13	12/12/2020 05:09	12/12/2020 02:13	12/12/2020 05:09	2,93	4	11,73	CHI
20201264167	DOVERLANDIA	PW12374317RE	PARQUE DAS EMAS	12/12/2020 02:13	12/12/2020 05:09	12/12/2020 02:13	12/12/2020 05:09	2,93	4	11,73	CHI
20201264167	MINEIROS	PW12374317RE	PARQUE DAS EMAS	12/12/2020 02:13	12/12/2020 05:09	12/12/2020 02:13	12/12/2020 05:09	2,93	16	46,92	CHI
20201264167	PEROLANDIA	PW12374317RE	PARQUE DAS EMAS	12/12/2020 02:13	12/12/2020 05:09	12/12/2020 02:13	12/12/2020 05:09	2,93	3	8,80	CHI
20201264169	ESTRELA DO NORTE	SE12053851	MARA ROSA	12/12/2020 02:21	12/12/2020 08:38	12/12/2020 02:21	12/12/2020 08:38	6,28	3	18,83	CHI
20201264169	SANTA TEREZA DE GOIAS	SE12053851	MARA ROSA	12/12/2020 02:21	12/12/2020 08:38	12/12/2020 02:21	12/12/2020 08:38	6,28	11	69,03	CHI
20201264172	AMERICANO DO BRASIL	IB12000066	ITABERAI S2	12/12/2020 02:33	12/12/2020 09:02	12/12/2020 02:33	12/12/2020 09:02	6,47	1	6,47	CHI
20201264189	MINEIROS	MY12219457RE	PARQUE DAS EMAS	12/12/2020 02:33	12/12/2020 10:20	12/12/2020 02:33	12/12/2020 10:20	7,78	22	171,07	CHI
20201264224	PETROLINA DE GOIAS	PG12216919	PETROLINA	12/12/2020 02:37	12/12/2020 13:54	12/12/2020 02:37	12/12/2020 13:54	11,27	9	101,42	CHI
20201264224	SAO FRANCISCO DE GOIAS	PG12216919	PETROLINA	12/12/2020 02:37	12/12/2020 13:54	12/12/2020 02:37	12/12/2020 13:54	11,27	1	11,27	CHI
20201264176	INHUMAS	IX12326257	INHUMAS S1	12/12/2020 02:58	12/12/2020 04:50	12/12/2020 02:58	12/12/2020 04:50	1,85	18	33,36	CHI
20201264670	ITAPURANGA	IK12300186	ITAPURANGA	12/12/2020 02:58	12/12/2020 08:51	12/12/2020 02:58	12/12/2020 08:51	5,87	40	234,80	CHI
20201264177	MOZARLANDIA	MZ12055628	MOZARLANDIA	12/12/2020 03:07	12/12/2020 10:20	12/12/2020 03:07	12/12/2020 10:20	7,20	40	288,12	CHI
20201264177	CRIXAS	MZ12055628	MOZARLANDIA	12/12/2020 03:07	12/12/2020 10:20	12/12/2020 03:07	12/12/2020 10:20	7,20	26	187,28	CHI
20201264201	GOIANAPOLIS	GP16418479	DAIA S2	12/12/2020 03:13	12/12/2020 16:00	12/12/2020 03:13	12/12/2020 05:04	1,85	339	625,93	CHI
20201264201	LEOPOLDO DE BULHOES	GP16418479	DAIA S2	12/12/2020 03:13	12/12/2020 16:00	12/12/2020 03:13	12/12/2020 05:04	1,85	342	631,47	CHI
20201264201	LEOPOLDO DE BULHOES	GP12210815	DAIA S2	12/12/2020 03:13	12/12/2020 16:00	12/12/2020 03:13	12/12/2020 05:07	1,91	2	3,81	CHI
20201264201	LEOPOLDO DE BULHOES	GP16418479	DAIA S2	12/12/2020 03:13	12/12/2020 16:00	12/12/2020 05:07	12/12/2020 05:11	0,06	342	20,62	CHI
20201264201	GOIANAPOLIS	GP16418479	DAIA S2	12/12/2020 03:13	12/12/2020 16:00	12/12/2020 05:07	12/12/2020 05:11	0,06	339	20,43	CHI
20201264201	GAMELEIRA DE GOIAS	GP12210815	DAIA S2	12/12/2020 03:13	12/12/2020 16:00	12/12/2020 03:13	12/12/2020 09:01	5,81	2	11,61	CHI
20201264201	GOIANAPOLIS	GP12210815	DAIA S2	12/12/2020 03:13	12/12/2020 16:00	12/12/2020 03:13	12/12/2020 09:01	5,81	33	191,59	CHI
20201264201	BONFINOPOLIS	GP12210815	DAIA S2	12/12/2020 03:13	12/12/2020 16:00	12/12/2020 03:13	12/12/2020 09:01	5,81	44	255,46	CHI
20201264201	LEOPOLDO DE BULHOES	GP12210815	DAIA S2	12/12/2020 03:13	12/12/2020 16:00	12/12/2020 03:13	12/12/2020 09:01	5,81	62	359,96	CHI
20201264201	LEOPOLDO DE BULHOES	GP12210815	DAIA S2	12/12/2020 03:13	12/12/2020 16:00	12/12/2020 03:13	12/12/2020 09:01	5,80	2	11,60	CHI
20201264201	BONFINOPOLIS	GP12210815	DAIA S2	12/12/2020 03:13	12/12/2020 16:00	12/12/2020 03:13	12/12/2020 16:00	12,79	9	115,10	CHI
20201264201	LEOPOLDO DE BULHOES	GP12210815	DAIA S2	12/12/2020 03:13	12/12/2020 16:00	12/12/2020 03:13	12/12/2020 16:00	12,79	1	12,79	CHI
20201264181	CAMPOS BELOS	CH12028137	SAO DOMINGOS	12/12/2020 03:17	12/12/2020 08:21	12/12/2020 03:17	12/12/2020 08:21	5,05	331	1672,47	CHI
20201264732	MINEIROS	MY12324340	PARQUE DAS EMAS	12/12/2020 03:27	12/12/2020 09:33	12/12/2020 03:27	12/12/2020 09:33	6,09	13	79,20	CHI
20201264604	CACHOEIRA DE GOIAS	CG12289761	FIRMINOPOLIS S2	12/12/2020 03:40	12/12/2020 15:38	12/12/2020 03:40	12/12/2020 15:38	11,96	18	215,29	CHI
20201264789	VILA PROPICIO	GE12243252	GOIANESIA S1	12/12/2020 03:45	12/12/2020 10:36	12/12/2020 03:45	12/12/2020 10:36	6,84	10	68,43	CHI
20201264196	DIORAMA	DI12066071	ARENOPOLIS	12/12/2020 03:57	12/12/2020 13:07	12/12/2020 03:57	12/12/2020 13:07	9,16	29	265,60	CHI
20201264312	JOVIANIA	JV12050204	VICENTINOPOLIS	12/12/2020 03:57	12/12/2020 07:41	12/12/2020 03:57	12/12/2020 07:41	3,73	2	7,46	CHI
20201264312	PONTALINA	JV12050204	VICENTINOPOLIS	12/12/2020 03:57	12/12/2020 07:41	12/12/2020 03:57	12/12/2020 07:41	3,73	26	96,96	CHI
20201264197	GOIATUBA	GT12296904	GOIATUBA S2	12/12/2020 04:01	13/12/2020 08:43	12/12/2020 04:01	13/12/2020 08:43	28,69	2	57,37	CHI
20201264199	SANCLERLANDIA	SC12008814	FIRMINOPOLIS S2	12/12/2020 04:03	12/12/2020 07:53	12/12/2020 04:03	12/12/2020 07:53	3,82	19	72,60	CHI
20201264329	FORMOSO	FO12377609	MARA ROSA	12/12/2020 04:17	12/12/2020 12:37	12/12/2020 04:17	12/12/2020 12:37	8,33	8	66,67	CHI
20201264287	NOVA AMERICA	NM12318470	RUBIATABA	12/12/2020 04:21	12/12/2020 10:29	12/12/2020 04:21	12/12/2020 10:29	6,12	16	97,93	CHI
20201264213	SANCLERLANDIA	SL12019498	SAO LUIZ DOS MONTES BELOS	12/12/2020 04:30	12/12/2020 07:52	12/12/2020 04:30	12/12/2020 07:52	3,35	4	13,41	CHI
20201264430	AURILANDIA	CG12391526	FIRMINOPOLIS S2	12/12/2020 04:33	12/12/2020 16:22	12/12/2020 04:33	12/12/2020 16:22	11,81	2	23,62	CHI
20201264430	PARAUNA	CG12391526	FIRMINOPOLIS S2	12/12/2020 04:33	12/12/2020 16:22	12/12/2020 04:33	12/12/2020 16:22	11,81	32	377,92	CHI
20201264430	CACHOEIRA DE GOIAS	CG12391526	FIRMINOPOLIS S2	12/12/2020 04:33	12/12/2020 16:22	12/12/2020 04:33	12/12/2020 16:22	11,81	11	129,91	CHI
20201264219	URUACU	UR12000054RE	CAMPINORTE	12/12/2020 04:41	12/12/2020 08:26	12/12/2020 04:41	12/12/2020 08:26	3,75	93	348,47	CHI
20201264219	NOVA IGUACU DE GOIAS	UR12000054RE	CAMPINORTE	12/12/2020 04:41	12/12/2020 08:26	12/12/2020 04:41	12/12/2020 08:26	3,75	19	71,19	CHI
20201264575	PALMEIRAS DE GOIAS	PL12016686	PALMEIRAS	12/12/2020 04:41	12/12/2020 11:03	12/12/2020 04:41	12/12/2020 11:03	6,35	11	69,88	CHI
20201264875	VILA BOA	FA12042061	ITUIQUIRA	12/12/2020 04:43	12/12/2020 11:35	12/12/2020 04:43	12/12/2020 11:35	6,86	1	6,86	CHI
20201264875	FLORES DE GOIAS	FA12042061	ITUIQUIRA	12/12/2020 04:43	12/12/2020 11:35	12/12/2020 04:43	12/12/2020 11:35	6,86	1	6,86	CHI
20201264277	MOSSAMEDES	SC12003889	FIRMINOPOLIS S2	12/12/2020 04:44	12/12/2020 07:27	12/12/2020 04:44	12/12/2020 07:27	2,71	5	13,53	CHI
20201264277	SANCLERLANDIA	SC12003889	FIRMINOPOLIS S2	12/12/2020 04:44	12/12/2020 07:27	12/12/2020 04:44	12/12/2020 07:27	2,71	16	43,30	CHI
20201264277	ADELANDIA	SC12003889	FIRMINOPOLIS S2	12/12/2020 04:44	12/12/2020 07:27	12/12/2020 04:44	12/12/2020 07:27	2,71	24	64,95	CHI

20201264225	PORANGATU	PO21135300	NOVO PLANALTO	12/12/2020 04:51	12/12/2020 07:45	12/12/2020 04:51	12/12/2020 07:45	2,89	2	5,79	CHI
20201264311	ABADIANIA	AA12180462	DAIA S2	12/12/2020 04:51	12/12/2020 18:21	12/12/2020 04:51	12/12/2020 18:21	13,49	5	67,46	CHI
20201264229	ITAPURANGA	00930224	ITAPURANGA	12/12/2020 04:55	12/12/2020 17:00	12/12/2020 04:55	12/12/2020 06:02	1,12	339	379,96	CHI
20201264229	ITAPURANGA	00930224	ITAPURANGA	12/12/2020 04:55	12/12/2020 17:00	12/12/2020 08:01	12/12/2020 08:04	0,05	339	17,52	CHI
20201264229	GOIAS	IK13000010	ITAPURANGA	12/12/2020 04:55	12/12/2020 17:00	12/12/2020 04:55	12/12/2020 11:45	6,85	1	6,85	CHI
20201264229	ITAPURANGA	IK13000010	ITAPURANGA	12/12/2020 04:55	12/12/2020 17:00	12/12/2020 04:55	12/12/2020 11:45	6,85	1	6,85	CHI
20201264229	ITAPURANGA	00930224	ITAPURANGA	12/12/2020 04:55	12/12/2020 17:00	12/12/2020 11:45	12/12/2020 12:06	0,34	339	114,98	CHI
20201264229	ITAPURANGA	00930224	ITAPURANGA	12/12/2020 04:55	12/12/2020 17:00	12/12/2020 12:36	12/12/2020 13:27	0,85	339	286,64	CHI
20201264229	GOIAS	00930224	ITAPURANGA	12/12/2020 04:55	12/12/2020 17:00	12/12/2020 04:55	12/12/2020 16:39	11,74	2	23,47	CHI
20201264229	ITAPURANGA	00930224	ITAPURANGA	12/12/2020 04:55	12/12/2020 17:00	12/12/2020 04:55	12/12/2020 16:39	11,74	648	7604,82	CHI
20201264229	GUARAITA	00930224	ITAPURANGA	12/12/2020 04:55	12/12/2020 17:00	12/12/2020 04:55	12/12/2020 16:39	11,74	18	211,25	CHI
20201264229	ITAPURANGA	IK13000010	ITAPURANGA	12/12/2020 04:55	12/12/2020 17:00	12/12/2020 04:57	12/12/2020 16:39	11,69	1	11,69	CHI
20201264229	GOIAS	IK13000010	ITAPURANGA	12/12/2020 04:55	12/12/2020 17:00	12/12/2020 04:55	12/12/2020 17:00	12,08	31	374,57	CHI
20201264229	GUARAITA	IK13000010	ITAPURANGA	12/12/2020 04:55	12/12/2020 17:00	12/12/2020 04:55	12/12/2020 17:00	12,08	1158	13991,86	CHI
20201264229	FAINA	IK13000010	ITAPURANGA	12/12/2020 04:55	12/12/2020 17:00	12/12/2020 04:55	12/12/2020 17:00	12,08	273	3298,60	CHI
20201264229	ITAPURANGA	IK13000010	ITAPURANGA	12/12/2020 04:55	12/12/2020 17:00	12/12/2020 04:55	12/12/2020 17:00	12,08	515	6222,63	CHI
20201264230	PALESTINA DE GOIAS	AY12000026RE	ARENOPOLIS	12/12/2020 05:02	12/12/2020 09:21	12/12/2020 05:02	12/12/2020 09:21	4,31	3	12,93	CHI
20201264230	ARENOPOLIS	AY12000026RE	ARENOPOLIS	12/12/2020 05:02	12/12/2020 09:21	12/12/2020 05:02	12/12/2020 09:21	4,31	81	349,20	CHI
20201264306	ITAPIRAPUA	IU12018852	MATRINCHA	12/12/2020 05:03	12/12/2020 08:21	12/12/2020 05:03	12/12/2020 08:21	3,30	36	118,70	CHI
20201264647	CAIAPONIA	MV12030666	MONTIVIDIU T	12/12/2020 05:06	12/12/2020 08:56	12/12/2020 05:06	12/12/2020 08:56	3,83	19	72,81	CHI
20201264647	MONTIVIDIU	MV12030666	MONTIVIDIU T	12/12/2020 05:06	12/12/2020 08:56	12/12/2020 05:06	12/12/2020 08:56	3,83	22	84,31	CHI
20201265769	JARAGUA	JA12298032	JARAGUA	12/12/2020 05:06	12/12/2020 11:47	12/12/2020 05:06	12/12/2020 11:47	6,68	141	942,00	CHI
20201264236	MORRINHOS	MR12000286	MORRINHOS	12/12/2020 05:08	13/12/2020 11:50	12/12/2020 05:08	13/12/2020 11:50	30,70	3	92,09	CHI
20201264237	ORIZONA	OZ12043232RE	PIRES DO RIO S2	12/12/2020 05:10	12/12/2020 11:12	12/12/2020 05:10	12/12/2020 11:12	6,03	51	307,46	CHI
20201264432	ITAUCU	IX12013157	INHUMAS S2	12/12/2020 05:11	12/12/2020 08:42	12/12/2020 05:11	12/12/2020 08:42	3,51	5	17,54	CHI
20201264432	SANTA ROSA DE GOIAS	IX12013157	INHUMAS S2	12/12/2020 05:11	12/12/2020 08:42	12/12/2020 05:11	12/12/2020 08:42	3,51	11	38,58	CHI
20201264239	GOIANIA	GN12040382	REAL S1	12/12/2020 05:12	12/12/2020 07:50	12/12/2020 05:12	12/12/2020 07:50	2,63	82	215,68	CHI
20201264240	ANICUNS	AC21000076	ANICUNS	12/12/2020 05:12	12/12/2020 10:53	12/12/2020 05:12	12/12/2020 10:53	5,68	2	11,36	CHI
20201264933	GOIANIA	GN11040981	REAL S1	12/12/2020 05:12	12/12/2020 10:19	12/12/2020 05:12	12/12/2020 10:19	5,11	128	654,58	CHI
20201264243	MUTUNOPOLIS	MU12391672	MARA ROSA	12/12/2020 05:18	12/12/2020 08:26	12/12/2020 05:18	12/12/2020 08:26	3,12	7	21,82	CHI
20201264243	AMARALINA	MU12391672	MARA ROSA	12/12/2020 05:18	12/12/2020 08:26	12/12/2020 05:18	12/12/2020 08:26	3,12	87	271,22	CHI
20201264650	NIQUELANDIA	NQ12262921	BARRO ALTO	12/12/2020 05:18	12/12/2020 10:04	12/12/2020 05:18	12/12/2020 10:04	4,75	6	28,51	CHI
20201264244	ANAPOLIS	AN21265113	NEROPOLIS S1	12/12/2020 05:21	12/12/2020 12:12	12/12/2020 05:21	12/12/2020 12:12	6,84	2	13,68	CHI
20201264245	TURVELANDIA	TD12213488	RIO DOS BOIS	12/12/2020 05:21	12/12/2020 08:17	12/12/2020 05:21	12/12/2020 08:17	2,92	6	17,54	CHI
20201264245	SANTA HELENA DE GOIAS	TD12213488	RIO DOS BOIS	12/12/2020 05:21	12/12/2020 08:17	12/12/2020 05:21	12/12/2020 08:17	2,92	3	8,77	CHI
20201265151	ITAJA	IM12205202	ITAJA S2	12/12/2020 05:24	12/12/2020 11:53	12/12/2020 05:24	12/12/2020 11:53	6,49	1	6,49	CHI
20201265151	ITARUMA	IM12205202	ITAJA S2	12/12/2020 05:24	12/12/2020 11:53	12/12/2020 05:24	12/12/2020 11:53	6,49	12	77,94	CHI
20201264249	PIRACANJUBA	PJ21009596	PIRACANJUBA	12/12/2020 05:25	12/12/2020 13:38	12/12/2020 05:25	12/12/2020 13:38	8,21	1	8,21	CHI
20201265216	MINEIROS	MY12303343RE	PARQUE DAS EMAS	12/12/2020 05:25	12/12/2020 11:53	12/12/2020 05:25	12/12/2020 11:53	6,47	8	51,73	CHI
20201264251	IPORA	IR12060716	IPORA	12/12/2020 05:26	12/12/2020 09:13	12/12/2020 05:26	12/12/2020 09:13	3,77	15	56,58	CHI
20201264580	BONOPOLIS	BX12079321RE	SAO MIGUEL DO ARAGUAIA	12/12/2020 05:27	12/12/2020 11:59	12/12/2020 05:27	12/12/2020 11:59	6,53	59	385,04	CHI
20201264253	CATALAO	CT12333638RE	CATALAO S1	12/12/2020 05:28	12/12/2020 09:03	12/12/2020 05:28	12/12/2020 09:03	3,58	64	229,28	CHI
20201264254	SAO DOMINGOS	SD21134762	SAO DOMINGOS	12/12/2020 05:28	12/12/2020 09:20	12/12/2020 05:28	12/12/2020 09:20	3,87	1	3,87	CHI
20201265181	CAMPINACU	IH12360453	MINACU	12/12/2020 05:28	12/12/2020 10:34	12/12/2020 05:28	12/12/2020 10:34	5,09	5	25,46	CHI
20201265181	MINACU	IH12360453	MINACU	12/12/2020 05:28	12/12/2020 10:34	12/12/2020 05:28	12/12/2020 10:34	5,09	72	366,66	CHI
20201264257	PORANGATU	PO12102916	PORANGATU	12/12/2020 05:30	12/12/2020 13:43	12/12/2020 05:30	12/12/2020 09:27	3,95	1	3,95	CHI
20201264257	PORANGATU	PO12102916	PORANGATU	12/12/2020 05:30	12/12/2020 13:43	12/12/2020 05:30	12/12/2020 10:13	4,72	4	18,86	CHI
20201264257	PORANGATU	PO12102916	PORANGATU	12/12/2020 05:30	12/12/2020 13:43	12/12/2020 09:27	12/12/2020 10:13	0,77	1	0,77	CHI
20201264257	PORANGATU	PO12102916	PORANGATU	12/12/2020 05:30	12/12/2020 13:43	12/12/2020 05:30	12/12/2020 13:43	8,21	20	164,24	CHI
20201264257	PORANGATU	PO13262746	PORANGATU	12/12/2020 05:30	12/12/2020 13:43	12/12/2020 09:27	12/12/2020 13:43	4,26	1	4,26	CHI
20201264258	ALOANDIA	AD12108925	GOIATUBA S1	12/12/2020 05:31	12/12/2020 09:27	12/12/2020 05:31	12/12/2020 09:27	3,93	5	19,65	CHI

20201264258	MORRINHOS	AD12108925	GOIATUBA S1	12/12/2020 05:31	12/12/2020 09:27	12/12/2020 05:31	12/12/2020 09:27	3,93	2	7,86	CHI
20201264259	FORMOSA	FA12404372	ITUIQUIRA	12/12/2020 05:32	12/12/2020 08:17	12/12/2020 05:32	12/12/2020 08:17	2,74	166	454,70	CHI
20201265443	GOIATUBA	GT12000178	BOM JESUS DE GOIAS	12/12/2020 05:32	12/12/2020 18:24	12/12/2020 05:32	12/12/2020 18:24	12,85	27	347,08	CHI
20201265891	SANTA ROSA DE GOIAS	SR12019043	INHUMAS S1	12/12/2020 05:32	12/12/2020 14:25	12/12/2020 05:32	12/12/2020 14:25	8,87	3	26,61	CHI
20201264264	ALTO HORIZONTE	AJ12100313	SANTA TEREZINHA	12/12/2020 05:34	12/12/2020 07:52	12/12/2020 05:34	12/12/2020 07:52	2,28	10	22,85	CHI
20201265015	LUZIANIA	LZ12320196	RIO VERMELHO	12/12/2020 05:34	12/12/2020 09:13	12/12/2020 05:34	12/12/2020 09:13	3,65	11	40,15	CHI
20201264314	CRISTALINA	LZ12120015	MARAJOARA	12/12/2020 05:35	12/12/2020 08:39	12/12/2020 05:35	12/12/2020 08:39	3,06	11	33,71	CHI
20201264435	INDIARA	IY12299110LD	EDEIA	12/12/2020 05:35	12/12/2020 08:58	12/12/2020 05:35	12/12/2020 08:58	3,37	39	131,51	CHI
20201264271	CALDAS NOVAS	CN21100172	SERRA DE CALDAS	12/12/2020 05:39	12/12/2020 10:25	12/12/2020 05:39	12/12/2020 10:25	4,76	1	4,76	CHI
20201264540	JARAGUA	JA12221352	JARAGUA	12/12/2020 05:39	12/12/2020 08:08	12/12/2020 05:39	12/12/2020 08:08	2,48	56	138,79	CHI
20201264272	PIRACANJUBA	PJ21182749	PIRACANJUBA	12/12/2020 05:40	12/12/2020 10:07	12/12/2020 05:40	12/12/2020 10:07	4,44	1	4,44	CHI
20201264274	PALESTINA DE GOIAS	PY21345495	PALESTINA	12/12/2020 05:41	12/12/2020 09:49	12/12/2020 05:41	12/12/2020 09:49	4,12	1	4,12	CHI
20201264275	ITAJA	IJ12161267	ITAJA S2	12/12/2020 05:43	12/12/2020 08:13	12/12/2020 05:43	12/12/2020 08:13	2,49	3	7,47	CHI
20201264275	APORE	IJ12161267	ITAJA S2	12/12/2020 05:43	12/12/2020 08:13	12/12/2020 05:43	12/12/2020 08:13	2,49	1	2,49	CHI
20201264284	FORMOSA	FA12038556	SAO JOAO D ALIANCA	12/12/2020 05:53	12/12/2020 11:07	12/12/2020 05:53	12/12/2020 11:07	5,22	101	527,50	CHI
20201264284	FLORES DE GOIAS	FA12038556	SAO JOAO D ALIANCA	12/12/2020 05:53	12/12/2020 11:07	12/12/2020 05:53	12/12/2020 11:07	5,22	7	36,56	CHI
20201264389	LUZIANIA	LZ12330783RE	MARAJOARA	12/12/2020 05:53	12/12/2020 08:04	12/12/2020 05:53	12/12/2020 08:04	2,18	214	465,51	CHI
20201264825	SAO FRANCISCO DE GOIAS	SF12039351	SAO FRANCISCO DE GOIAS	12/12/2020 05:53	12/12/2020 14:54	12/12/2020 05:53	12/12/2020 14:54	9,02	19	171,30	CHI
20201264285	MORRINHOS	MR21122156	MORRINHOS	12/12/2020 05:55	12/12/2020 07:29	12/12/2020 05:55	12/12/2020 07:29	1,57	1	1,57	CHI
20201264291	JATAI	JT12219503	JATAI S3	12/12/2020 05:55	12/12/2020 11:34	12/12/2020 05:55	12/12/2020 11:34	5,64	4	22,58	CHI
20201264292	LEOPOLDO DE BULHOES	SV21015251	DAIA S2	12/12/2020 05:55	12/12/2020 12:38	12/12/2020 05:55	12/12/2020 12:38	6,71	1	6,71	CHI
20201264293	CRIXAS	CX12319064	SERRA DO OURO	12/12/2020 05:55	12/12/2020 09:06	12/12/2020 05:55	12/12/2020 09:06	3,17	4	12,69	CHI
20201264401	SANTA FE DE GOIAS	RN12206843	BRITANIA	12/12/2020 05:55	12/12/2020 10:10	12/12/2020 05:55	12/12/2020 10:10	4,26	22	93,62	CHI
20201264294	GOIANDIRA	GD12078359	CATALAO S1	12/12/2020 05:56	12/12/2020 08:35	12/12/2020 05:56	12/12/2020 08:35	2,64	25	65,90	CHI
20201264300	EDEIA	EA12000048	EDEIA	12/12/2020 05:59	12/12/2020 09:19	12/12/2020 05:59	12/12/2020 09:19	3,32	32	106,20	CHI
20201264965	PORANGATU	PO12240217	MARA ROSA	12/12/2020 05:59	12/12/2020 10:37	12/12/2020 05:59	12/12/2020 10:37	4,62	4	18,48	CHI
20201265256	MONTES CLAROS DE GOIAS	JR12022269RE	BRITANIA	12/12/2020 05:59	12/12/2020 14:12	12/12/2020 05:59	12/12/2020 14:12	8,21	270	2217,23	CHI
20201265256	JUSSARA	JR12022269RE	BRITANIA	12/12/2020 05:59	12/12/2020 14:12	12/12/2020 05:59	12/12/2020 14:12	8,21	30	246,36	CHI
20201264303	JARAGUA	JA21027789	GOIANESIA S2	12/12/2020 06:00	12/12/2020 14:50	12/12/2020 06:00	12/12/2020 14:50	8,83	1	8,83	CHI
20201264304	PORANGATU	PO12088718	PORANGATU	12/12/2020 06:00	12/12/2020 10:45	12/12/2020 06:00	12/12/2020 10:45	4,75	4	19,00	CHI
20201264680	NOVA CRIXAS	NA12156613	MOZARLANDIA	12/12/2020 06:00	12/12/2020 12:19	12/12/2020 06:00	12/12/2020 12:19	6,33	34	215,25	CHI
20201264680	CRIXAS	NA12156613	MOZARLANDIA	12/12/2020 06:00	12/12/2020 12:19	12/12/2020 06:00	12/12/2020 12:19	6,33	2	12,66	CHI
20201264350	MINEIROS	7085043	PARQUE DAS EMAS	12/12/2020 06:01	12/12/2020 13:55	12/12/2020 06:01	12/12/2020 13:55	7,90	9	71,10	CHI
20201264350	DOVERLANDIA	7085043	PARQUE DAS EMAS	12/12/2020 06:01	12/12/2020 13:55	12/12/2020 06:01	12/12/2020 13:55	7,90	31	244,90	CHI
20201264756	CORUMBAIBA	CI12131032	VILA CORUMBA	12/12/2020 06:01	12/12/2020 14:36	12/12/2020 06:01	12/12/2020 14:36	8,59	21	180,33	CHI
20201264318	MIMOSO DE GOIAS	NQ12371855RE	BARRO ALTO	12/12/2020 06:02	12/12/2020 08:25	12/12/2020 06:02	12/12/2020 08:25	2,37	4	9,49	CHI
20201264318	NIQUELANDIA	NQ12371855RE	BARRO ALTO	12/12/2020 06:02	12/12/2020 08:25	12/12/2020 06:02	12/12/2020 08:25	2,37	246	583,77	CHI
20201264830	VILA PROPICIO	7587203	GOIANESIA S1	12/12/2020 06:02	12/12/2020 10:52	12/12/2020 06:02	12/12/2020 10:52	4,83	92	444,33	CHI
20201264321	ALTO PARAISO DE GOIAS	ND12302636	IACIARA S2	12/12/2020 06:03	12/12/2020 13:36	12/12/2020 06:03	12/12/2020 13:36	7,54	19	143,29	CHI
20201264321	NOVA ROMA	ND12302636	IACIARA S2	12/12/2020 06:03	12/12/2020 13:36	12/12/2020 06:03	12/12/2020 13:36	7,54	101	761,68	CHI
20201264321	SAO JOAO D ALIANCA	ND12302636	IACIARA S2	12/12/2020 06:03	12/12/2020 13:36	12/12/2020 06:03	12/12/2020 13:36	7,54	13	98,04	CHI
20201264322	ALTO PARAISO DE GOIAS	BF12349123	FLORES DE GOIAS	12/12/2020 06:03	12/12/2020 08:58	12/12/2020 06:03	12/12/2020 08:58	2,90	4	11,62	CHI
20201264322	SAO JOAO D ALIANCA	BF12349123	FLORES DE GOIAS	12/12/2020 06:03	12/12/2020 08:58	12/12/2020 06:03	12/12/2020 08:58	2,90	2	5,81	CHI
20201264323	SENADOR CANEDO	10020692011	GOIANIA LESTE S1	12/12/2020 06:03	12/12/2020 07:35	12/12/2020 06:03	12/12/2020 07:35	1,52	1	1,52	CHI
20201266021	CORUMBAIBA	CI12039771	VILA CORUMBA	12/12/2020 06:04	12/12/2020 15:33	12/12/2020 06:04	12/12/2020 15:33	9,47	3	28,40	CHI
20201264331	ITABERAI	IB12108138	ITABERAI S2	12/12/2020 06:05	12/12/2020 10:24	12/12/2020 06:05	12/12/2020 10:24	4,31	29	124,86	CHI
20201264332	EDEALINA	EA12257919RE	EDEIA	12/12/2020 06:05	12/12/2020 07:41	12/12/2020 06:05	12/12/2020 07:41	1,59	1	1,59	CHI
20201264332	EDEIA	EA12257919RE	EDEIA	12/12/2020 06:05	12/12/2020 07:41	12/12/2020 06:05	12/12/2020 07:41	1,59	48	76,15	CHI
20201264662	NOVA ROMA	MA12236705	SAO DOMINGOS	12/12/2020 06:06	12/12/2020 09:03	12/12/2020 06:06	12/12/2020 09:03	2,94	57	167,74	CHI
20201264662	MONTE ALEGRE DE GOIAS	MA12236705	SAO DOMINGOS	12/12/2020 06:06	12/12/2020 09:03	12/12/2020 06:06	12/12/2020 09:03	2,94	10	29,43	CHI
20201265155	NOVA CRIXAS	NA12330161	NOVA CRIXAS	12/12/2020 06:06	13/12/2020 09:51	12/12/2020 06:06	13/12/2020 09:51	27,74	4	110,97	CHI

20201264339	EDEIA	EA12089863	EDEIA	12/12/2020 06:07	12/12/2020 09:03	12/12/2020 06:07	12/12/2020 09:03	2,93	3	8,78	CHI
20201264342	GOIATUBA	GT12030782	RIO DOS BOIS	12/12/2020 06:07	12/12/2020 10:47	12/12/2020 06:07	12/12/2020 10:47	4,65	1	4,65	CHI
20201264342	PORTEIRAO	GT12030782	RIO DOS BOIS	12/12/2020 06:07	12/12/2020 10:47	12/12/2020 06:07	12/12/2020 10:47	4,65	3	13,96	CHI
20201266263	NOVA CRIXAS	NA12075890	MOZARLANDIA	12/12/2020 06:07	12/12/2020 21:57	12/12/2020 06:07	12/12/2020 21:57	15,83	6	94,97	CHI
20201264344	APARECIDA DE GOIANIA	10013612245	INDEPENDENCIA S2	12/12/2020 06:08	12/12/2020 07:14	12/12/2020 06:08	12/12/2020 07:14	1,10	1	1,10	CHI
20201264345	FAZENDA NOVA	FN21295312	IPORA	12/12/2020 06:08	12/12/2020 11:36	12/12/2020 06:08	12/12/2020 11:36	5,46	1	5,46	CHI
20201264348	AMARALINA	MQ12208443	NOVA CRIXAS	12/12/2020 06:08	12/12/2020 10:49	12/12/2020 06:08	12/12/2020 10:49	4,67	1	4,67	CHI
20201264348	MARA ROSA	MQ12208443	NOVA CRIXAS	12/12/2020 06:08	12/12/2020 10:49	12/12/2020 06:08	12/12/2020 10:49	4,67	1	4,67	CHI
20201264413	ITAPIRAPUA	IU12121437	MATRINCHA	12/12/2020 06:08	12/12/2020 09:13	12/12/2020 06:08	12/12/2020 09:13	3,07	16	49,11	CHI
20201264353	ALTO PARAISO DE GOIAS	BF21146144	FLORES DE GOIAS	12/12/2020 06:09	12/12/2020 07:58	12/12/2020 06:09	12/12/2020 07:58	1,81	1	1,81	CHI
20201264355	CRISTALINA	KR12160086	PAMPLONA	12/12/2020 06:09	12/12/2020 14:48	12/12/2020 06:09	12/12/2020 14:48	8,64	1	8,64	CHI
20201264356	GUAPO	GA12008543	GUAPO S2	12/12/2020 06:09	12/12/2020 09:22	12/12/2020 06:09	12/12/2020 09:22	3,21	29	93,06	CHI
20201264356	CAMPESTRE DE GOIAS	GA12008543	GUAPO S2	12/12/2020 06:09	12/12/2020 09:22	12/12/2020 06:09	12/12/2020 09:22	3,21	12	38,51	CHI
20201264429	SAO MIGUEL DO ARAGUAIA	SM12384229	SAO MIGUEL DO ARAGUAIA	12/12/2020 06:09	12/12/2020 14:10	12/12/2020 06:09	12/12/2020 14:10	8,01	4	32,06	CHI
20201265466	CAIAPONIA	PH12390191	CAIAPONIA	12/12/2020 06:09	12/12/2020 11:47	12/12/2020 06:09	12/12/2020 11:47	5,62	2	11,25	CHI
20201265466	PIRANHAS	PH12390191	CAIAPONIA	12/12/2020 06:09	12/12/2020 11:47	12/12/2020 06:09	12/12/2020 11:47	5,62	7	39,36	CHI
20201264361	CRISTALINA	KR12313551	CRISTALINA S2	12/12/2020 06:10	12/12/2020 12:44	12/12/2020 06:10	12/12/2020 12:44	6,55	93	609,56	CHI
20201264943	FORMOSO	FO12185309	MARA ROSA	12/12/2020 06:10	12/12/2020 15:55	12/12/2020 06:10	12/12/2020 15:55	9,75	7	68,24	CHI
20201264973	FAINA	AZ12404563	GOIAS	12/12/2020 06:10	12/12/2020 14:52	12/12/2020 06:10	12/12/2020 14:52	8,70	1	8,70	CHI
20201264973	ARAGUAPAZ	AZ12404563	GOIAS	12/12/2020 06:10	12/12/2020 14:52	12/12/2020 06:10	12/12/2020 14:52	8,70	20	173,94	CHI
20201264365	JATAI	JT12213671	JATAI S1	12/12/2020 06:11	12/12/2020 11:17	12/12/2020 06:11	12/12/2020 11:17	5,09	5	25,46	CHI
20201264367	MONTES CLAROS DE GOIAS	ME12204903	IPORA	12/12/2020 06:11	12/12/2020 23:49	12/12/2020 06:11	12/12/2020 23:49	17,62	2	35,24	CHI
20201264471	AMARALINA	LC12182362	MARA ROSA	12/12/2020 06:11	12/12/2020 09:05	12/12/2020 06:11	12/12/2020 09:05	2,89	105	303,51	CHI
20201264471	MUTUNOPOLIS	LC12182362	MARA ROSA	12/12/2020 06:11	12/12/2020 09:05	12/12/2020 06:11	12/12/2020 09:05	2,89	2	5,78	CHI
20201264471	MARA ROSA	LC12182362	MARA ROSA	12/12/2020 06:11	12/12/2020 09:05	12/12/2020 06:11	12/12/2020 09:05	2,89	8	23,12	CHI
20201264512	BOM JARDIM DE GOIAS	BM12231130	BOM JARDIM	12/12/2020 06:13	12/12/2020 09:55	12/12/2020 06:13	12/12/2020 09:55	3,69	10	36,93	CHI
20201264374	CAMPO ALEGRE DE GOIAS	CM12203138	CAMPO ALEGRE DE GOIAS	12/12/2020 06:14	12/12/2020 08:10	12/12/2020 06:14	12/12/2020 08:10	1,93	5	9,65	CHI
20201264376	CAIAPONIA	CP12381055	CAIAPONIA	12/12/2020 06:14	12/12/2020 10:04	12/12/2020 06:14	12/12/2020 10:04	3,83	61	233,51	CHI
20201264377	PORTELANDIA	MY12303805	PARQUE DAS EMAS	12/12/2020 06:14	12/12/2020 08:21	12/12/2020 06:14	12/12/2020 08:21	2,11	2	4,22	CHI
20201264377	MINEIROS	MY12303805	PARQUE DAS EMAS	12/12/2020 06:14	12/12/2020 08:21	12/12/2020 06:14	12/12/2020 08:21	2,11	2	4,22	CHI
20201264614	PROFESSOR JAMIL SAFADY	PJ12063080	ROCHEDO	12/12/2020 06:14	12/12/2020 11:59	12/12/2020 06:14	12/12/2020 11:59	5,75	13	74,71	CHI
20201264383	FAINA	FC12376464	GOIAS	12/12/2020 06:16	12/12/2020 13:19	12/12/2020 06:16	12/12/2020 13:19	7,04	7	49,31	CHI
20201264384	BARRO ALTO	BA12210738	BARRO ALTO	12/12/2020 06:16	12/12/2020 23:37	12/12/2020 06:16	12/12/2020 23:37	17,34	1	17,34	CHI
20201264912	JAUPACI	JP12354611	IPORA	12/12/2020 06:16	12/12/2020 10:45	12/12/2020 06:16	12/12/2020 10:45	4,49	8	35,91	CHI
20201265411	GOIATUBA	GT12033074	BOM JESUS DE GOIAS	12/12/2020 06:18	12/12/2020 18:54	12/12/2020 06:18	12/12/2020 18:54	12,59	18	226,63	CHI
20201266524	VILA PROPICIO	GE12258997	GOIANESIA S2	12/12/2020 06:18	13/12/2020 18:08	12/12/2020 06:18	13/12/2020 18:08	35,83	10	358,29	CHI
20201264390	ANICUNS	TV12005709	FIRMINOPOLIS S2	12/12/2020 06:19	12/12/2020 09:10	12/12/2020 06:19	12/12/2020 09:10	2,84	18	51,20	CHI
20201264398	GOIANIA	10571814	GOIANIA LESTE S2	12/12/2020 06:20	12/12/2020 16:21	12/12/2020 06:20	12/12/2020 16:21	10,01	1	10,01	CHI
20201264795	CROMINIA	CQ12077788	PONTALINA	12/12/2020 06:20	12/12/2020 12:31	12/12/2020 06:20	12/12/2020 12:31	6,18	11	67,99	CHI
20201264795	PROFESSOR JAMIL SAFADY	CQ12077788	PONTALINA	12/12/2020 06:20	12/12/2020 12:31	12/12/2020 06:20	12/12/2020 12:31	6,18	6	37,09	CHI
20201264404	MUNDO NOVO DE GOIAS	MH12391949	NOVA CRIXAS	12/12/2020 06:21	12/12/2020 09:51	12/12/2020 06:21	12/12/2020 09:51	3,48	41	142,85	CHI
20201264405	FAINA	FC12204586	GOIAS	12/12/2020 06:22	12/12/2020 21:38	12/12/2020 06:22	12/12/2020 21:38	15,26	4	61,04	CHI
20201264522	IACIARA	GY12465246	IACIARA S1	12/12/2020 06:22	12/12/2020 08:52	12/12/2020 06:22	12/12/2020 08:52	2,49	3	7,46	CHI
20201264522	GUARANI DE GOIAS	GY12465246	IACIARA S1	12/12/2020 06:22	12/12/2020 08:52	12/12/2020 06:22	12/12/2020 08:52	2,49	14	34,81	CHI
20201264558	SILVANIA	SV12012809	VIANOPOLIS	12/12/2020 06:22	13/12/2020 08:52	12/12/2020 06:22	13/12/2020 08:52	26,49	68	1801,28	CHI
20201264411	VARJAO	VJ21381661	GUAPO S2	12/12/2020 06:23	12/12/2020 10:33	12/12/2020 06:23	12/12/2020 10:33	4,16	1	4,16	CHI
20201264412	MINACU	IH12242031	MINACU	12/12/2020 06:23	13/12/2020 08:26	12/12/2020 06:23	13/12/2020 08:26	26,04	4	104,17	CHI
20201264572	CAIAPONIA	CP12349672	CAIAPONIA	12/12/2020 06:23	12/12/2020 10:55	12/12/2020 06:23	12/12/2020 10:55	4,53	7	31,73	CHI
20201264416	QUIRINOPOLIS	QI12351556	SANTA HELENA S1	12/12/2020 06:24	12/12/2020 14:42	12/12/2020 06:24	12/12/2020 14:42	8,29	1	8,29	CHI
20201264420	PALMEIRAS DE GOIAS	PL12000059	PALMEIRAS	12/12/2020 06:25	12/12/2020 12:09	12/12/2020 06:25	12/12/2020 12:09	5,72	5	28,60	CHI
20201264772	RIO VERDE	RV12025958	RIO VERDE S1	12/12/2020 06:25	13/12/2020 00:16	12/12/2020 06:25	12/12/2020 19:15	12,82	28	359,07	CHI

20201264772	RIO VERDE	RV12025958	RIO VERDE S1	12/12/2020 06:25	13/12/2020 00:16	12/12/2020 06:25	12/12/2020 21:00	14,57	15	218,61	CHI
20201264772	RIO VERDE	RV12025958	RIO VERDE S1	12/12/2020 06:25	13/12/2020 00:16	12/12/2020 06:25	13/12/2020 00:16	17,86	4	71,43	CHI
20201265067	FAINA	FC12147790	GOIAS	12/12/2020 06:25	12/12/2020 15:54	12/12/2020 06:25	12/12/2020 15:54	9,47	6	56,80	CHI
20201264424	ITAJA	IJ12321778RE	CACHOEIRA ALTA	12/12/2020 06:26	13/12/2020 17:14	12/12/2020 06:26	12/12/2020 19:34	13,14	6	78,81	CHI
20201264424	ITAJA	IJ12321778RE	CACHOEIRA ALTA	12/12/2020 06:26	13/12/2020 17:14	12/12/2020 22:02	12/12/2020 23:22	1,35	6	8,07	CHI
20201264424	ITAJA	IJ12321778RE	CACHOEIRA ALTA	12/12/2020 06:26	13/12/2020 17:14	12/12/2020 06:26	13/12/2020 13:12	30,77	1	30,77	CHI
20201264424	ITARUMA	IJ12321778RE	CACHOEIRA ALTA	12/12/2020 06:26	13/12/2020 17:14	12/12/2020 06:26	13/12/2020 13:53	31,45	3	94,34	CHI
20201264424	ITARUMA	IJ12321778RE	CACHOEIRA ALTA	12/12/2020 06:26	13/12/2020 17:14	12/12/2020 06:26	13/12/2020 15:00	32,56	24	781,44	CHI
20201264424	ITAJA	IJ12321778RE	CACHOEIRA ALTA	12/12/2020 06:26	13/12/2020 17:14	12/12/2020 06:26	13/12/2020 17:14	34,80	1	34,80	CHI
20201264425	PORANGATU	PO12217306	PORANGATU	12/12/2020 06:26	12/12/2020 10:49	12/12/2020 06:26	12/12/2020 10:49	4,37	12	52,49	CHI
20201264437	TERESINA DE GOIAS	TE12328535	FLORES DE GOIAS	12/12/2020 06:31	12/12/2020 11:02	12/12/2020 06:31	12/12/2020 11:02	4,52	4	18,06	CHI
20201264438	URUACU	UC12237456	MARA ROSA	12/12/2020 06:31	12/12/2020 10:45	12/12/2020 06:31	12/12/2020 10:45	4,23	5	21,13	CHI
20201264438	CAMPINACU	UC12237456	MARA ROSA	12/12/2020 06:31	12/12/2020 10:45	12/12/2020 06:31	12/12/2020 10:45	4,23	7	29,59	CHI
20201264442	ACREUNA	EU21279070	ACREUNA	12/12/2020 06:32	12/12/2020 08:23	12/12/2020 06:32	12/12/2020 08:23	1,85	1	1,85	CHI
20201264446	CACHOEIRA ALTA	CA21084331	CACHOEIRA ALTA	12/12/2020 06:34	12/12/2020 10:37	12/12/2020 06:34	12/12/2020 10:37	4,05	2	8,10	CHI
20201264667	VILA PROPICIO	NP12231823	GOIANESIA S1	12/12/2020 06:34	12/12/2020 22:09	12/12/2020 06:34	12/12/2020 22:09	15,58	18	280,37	CHI
20201263637	ORIZONA	OZ12338865	PIRES DO RIO S2	12/12/2020 06:35	12/12/2020 10:10	12/12/2020 06:35	12/12/2020 10:10	3,58	79	282,95	CHI
20201264453	VIANOPOLIS	OZ12084921RE	PIRES DO RIO S2	12/12/2020 06:35	12/12/2020 09:31	12/12/2020 06:35	12/12/2020 09:31	2,93	17	49,82	CHI
20201264453	ORIZONA	OZ12084921RE	PIRES DO RIO S2	12/12/2020 06:35	12/12/2020 09:31	12/12/2020 06:35	12/12/2020 09:31	2,93	110	322,36	CHI
20201264455	CRISTALINA	KR21290678	CRISTALINA S2	12/12/2020 06:35	12/12/2020 14:02	12/12/2020 06:35	12/12/2020 14:02	7,44	1	7,44	CHI
20201264458	UIRAPURU	UP12287175	SANTA TEREZINHA	12/12/2020 06:35	12/12/2020 08:46	12/12/2020 06:35	12/12/2020 08:46	2,17	3	6,50	CHI
20201264460	SANTA TEREZINHA DE GOIAS	SG12380710	SANTA TEREZINHA	12/12/2020 06:36	12/12/2020 08:21	12/12/2020 06:36	12/12/2020 08:21	1,73	8	13,88	CHI
20201264464	GOIANIA	11439981	GOYA S1	12/12/2020 06:37	12/12/2020 09:01	12/12/2020 06:37	12/12/2020 09:01	2,38	1	2,38	CHI
20201264687	PETROLINA DE GOIAS	PG12377584	PETROLINA	12/12/2020 06:37	12/12/2020 15:00	12/12/2020 06:37	12/12/2020 15:00	8,38	4	33,51	CHI
20201264687	SAO FRANCISCO DE GOIAS	PG12377584	PETROLINA	12/12/2020 06:37	12/12/2020 15:00	12/12/2020 06:37	12/12/2020 15:00	8,38	12	100,52	CHI
20201264711	FORMOSA	FA12318517	ITUIQUIRA	12/12/2020 06:39	13/12/2020 10:00	12/12/2020 06:39	13/12/2020 10:00	27,36	5	136,80	CHI
20201265620	LUZIANIA	LZ11164911	PIRES DO RIO S2	12/12/2020 06:40	13/12/2020 17:13	12/12/2020 06:40	13/12/2020 16:28	33,81	126	4259,71	CHI
20201265620	LUZIANIA	LZ13399881	PIRES DO RIO S2	12/12/2020 06:40	13/12/2020 17:13	13/12/2020 12:33	13/12/2020 16:28	3,92	89	348,95	CHI
20201265620	LUZIANIA	LZ12114519	PIRES DO RIO S2	12/12/2020 06:40	13/12/2020 17:13	13/12/2020 12:33	13/12/2020 16:55	4,36	23	100,24	CHI
20201265620	ORIZONA	LZ12114519	PIRES DO RIO S2	12/12/2020 06:40	13/12/2020 17:13	13/12/2020 12:33	13/12/2020 16:55	4,36	36	156,89	CHI
20201265620	LUZIANIA	LZ13370732	PIRES DO RIO S2	12/12/2020 06:40	13/12/2020 17:13	13/12/2020 12:33	13/12/2020 17:13	4,66	16	74,60	CHI
20201264962	IPAMERI	IP12112268	PIRES DO RIO S2	12/12/2020 06:41	13/12/2020 22:21	12/12/2020 06:41	13/12/2020 17:09	34,47	12	413,68	CHI
20201264962	IPAMERI	IP12112268	PIRES DO RIO S2	12/12/2020 06:41	13/12/2020 22:21	12/12/2020 06:41	13/12/2020 17:09	34,47	8	275,79	CHI
20201264962	IPAMERI	IP21202982	PIRES DO RIO S2	12/12/2020 06:41	13/12/2020 22:21	13/12/2020 21:54	13/12/2020 22:21	0,44	3	1,33	CHI
20201264873	PORANGATU	PO12202569	PORANGATU	12/12/2020 06:42	12/12/2020 13:52	12/12/2020 06:42	12/12/2020 13:52	7,15	7	50,07	CHI
20201264487	INHUMAS	IN21132777	ARACU	12/12/2020 06:43	12/12/2020 10:16	12/12/2020 06:43	12/12/2020 10:16	3,53	1	3,53	CHI
20201264491	VILA BOA	FA21062366	ITUIQUIRA	12/12/2020 06:44	12/12/2020 12:20	12/12/2020 06:44	12/12/2020 12:20	5,59	1	5,59	CHI
20201264888	GOIAS	GS12073885	MATRINCHA	12/12/2020 06:44	12/12/2020 11:01	12/12/2020 06:44	12/12/2020 11:01	4,28	15	64,20	CHI
20201264911	OURO VERDE DE GOIAS	OV12215905	NEROPOLIS S2	12/12/2020 06:44	12/12/2020 11:20	12/12/2020 06:44	12/12/2020 11:20	4,59	10	45,89	CHI
20201264645	ITARUMA	IM12058351	CACHOEIRA ALTA	12/12/2020 06:45	12/12/2020 10:51	12/12/2020 06:45	12/12/2020 10:51	4,09	18	73,71	CHI
20201266399	ORIZONA	OZ12114504	PIRES DO RIO S2	12/12/2020 06:45	12/12/2020 23:29	12/12/2020 06:45	12/12/2020 23:29	16,73	10	167,30	CHI
20201264497	JATAI	JT12000164	JATAI S2	12/12/2020 06:46	12/12/2020 10:52	12/12/2020 06:46	12/12/2020 10:52	4,09	1	4,09	CHI
20201264502	GUARINOS	GF12243567	SANTA TEREZINHA	12/12/2020 06:47	12/12/2020 11:11	12/12/2020 06:47	12/12/2020 11:11	4,39	12	52,71	CHI
20201264505	HIDROLANDIA	BV12117089	BELA VISTA S1	12/12/2020 06:47	12/12/2020 09:10	12/12/2020 06:47	12/12/2020 09:10	2,37	5	11,85	CHI
20201264511	NOVA CRIXAS	NA12091638	NOVA CRIXAS	12/12/2020 06:47	12/12/2020 11:37	12/12/2020 06:47	12/12/2020 11:37	4,82	9	43,38	CHI
20201266003	MONTES CLAROS DE GOIAS	ME12212902	IPORA	12/12/2020 06:47	12/12/2020 16:55	12/12/2020 06:47	12/12/2020 16:55	10,12	10	101,24	CHI
20201264507	MONTIVIDIU	MV12303520	MONTIVIDIU T	12/12/2020 06:48	12/12/2020 09:08	12/12/2020 06:48	12/12/2020 09:08	2,33	3	6,99	CHI
20201264507	RIO VERDE	MV12303520	MONTIVIDIU T	12/12/2020 06:48	12/12/2020 09:08	12/12/2020 06:48	12/12/2020 09:08	2,33	1	2,33	CHI
20201264517	ARACU	AR21323664	ARACU	12/12/2020 06:50	12/12/2020 10:32	12/12/2020 06:50	12/12/2020 10:32	3,70	2	7,39	CHI
20201264520	PONTALINA	PK21151623	PONTALINA	12/12/2020 06:51	12/12/2020 09:10	12/12/2020 06:51	12/12/2020 09:10	2,30	2	4,60	CHI
20201264524	VALPARAISO DE GOIAS	3350065798	PACAEMBU S2	12/12/2020 06:52	12/12/2020 08:57	12/12/2020 06:52	12/12/2020 08:57	2,07	1	2,07	CHI

20201264531	ABADIANIA	AA21319833	DAIA S2	12/12/2020 06:54	12/12/2020 11:19	12/12/2020 06:54	12/12/2020 11:19	4,40	7	30,83	CHI
20201264533	PALESTINA DE GOIAS	PY21193404	PALESTINA	12/12/2020 06:54	12/12/2020 10:43	12/12/2020 06:54	12/12/2020 10:43	3,80	1	3,80	CHI
20201264668	ESTRELA DO NORTE	MQ12208361	MARA ROSA	12/12/2020 06:54	12/12/2020 13:49	12/12/2020 06:54	12/12/2020 13:49	6,92	4	27,67	CHI
20201264537	TERESINA DE GOIAS	TE12276937	FLORES DE GOIAS	12/12/2020 06:55	12/12/2020 12:48	12/12/2020 06:55	12/12/2020 12:48	5,88	39	229,18	CHI
20201264538	ORIZONA	VN12073848	VIANOPOLIS	12/12/2020 06:55	13/12/2020 17:00	12/12/2020 06:55	13/12/2020 17:00	34,07	3	102,21	CHI
20201264543	MAMBAI	BQ12344370RE	IACIARA S2	12/12/2020 06:56	12/12/2020 08:53	12/12/2020 06:56	12/12/2020 08:53	1,94	1	1,94	CHI
20201264543	BURITINOPOLIS	BQ12344370RE	IACIARA S2	12/12/2020 06:56	12/12/2020 08:53	12/12/2020 06:56	12/12/2020 08:53	1,94	267	518,80	CHI
20201264612	AGUAS LINDAS DE GOIAS	SN12103544	AGUAS LINDAS DE GOIAS S1	12/12/2020 06:56	12/12/2020 07:56	12/12/2020 06:56	12/12/2020 07:56	0,98	4	3,94	CHI
20201264551	APARECIDA DE GOIANIA	10020396471	ANHANGUERA	12/12/2020 06:57	12/12/2020 08:31	12/12/2020 06:57	12/12/2020 08:31	1,56	1	1,56	CHI
20201264555	CACHOEIRA ALTA	CA21196168	CACHOEIRA ALTA	12/12/2020 06:58	12/12/2020 10:01	12/12/2020 06:58	12/12/2020 10:01	3,06	1	3,06	CHI
20201264562	ITABERAI	IB12000047	ITABERAI S2	12/12/2020 06:59	12/12/2020 08:57	12/12/2020 06:59	12/12/2020 08:57	1,96	9	17,65	CHI
20201264563	PIRES DO RIO	PR12051695	PIRES DO RIO S2	12/12/2020 06:59	12/12/2020 13:38	12/12/2020 06:59	12/12/2020 13:38	6,66	9	59,91	CHI
20201264564	PORANGATU	PO21189536	PORANGATU	12/12/2020 06:59	12/12/2020 09:13	12/12/2020 06:59	12/12/2020 09:13	2,23	1	2,23	CHI
20201264566	BELA VISTA DE GOIAS	BV31197969	BELA VISTA S1	12/12/2020 06:59	12/12/2020 10:30	12/12/2020 06:59	12/12/2020 10:30	3,51	1	3,51	CHI
20201264567	FORMOSO	FO12151052	PORANGATU	12/12/2020 07:00	12/12/2020 09:00	12/12/2020 07:00	12/12/2020 09:00	2,00	6	11,99	CHI
20201264655	PARAUNA	PU12295868	ACREUNA	12/12/2020 07:00	12/12/2020 10:18	12/12/2020 07:00	12/12/2020 10:18	3,29	10	32,95	CHI
20201264813	PALMINOPOLIS	PP12307055	PALMEIRAS	12/12/2020 07:00	12/12/2020 10:25	12/12/2020 07:00	12/12/2020 10:25	3,40	2	6,80	CHI
20201265129	GOIANIA	GN12267330	GOYA S1	12/12/2020 07:01	12/12/2020 09:11	12/12/2020 07:01	12/12/2020 09:11	2,15	3	6,46	CHI
20201265308	PONTALINA	PK12050288	GOIATUBA S1	12/12/2020 07:01	12/12/2020 10:29	12/12/2020 07:01	12/12/2020 10:29	3,45	6	20,70	CHI
20201265586	SILVANIA	SV12116679	DAIA S2	12/12/2020 07:01	12/12/2020 14:28	12/12/2020 07:01	12/12/2020 14:28	7,44	6	44,62	CHI
20201265586	GAMELEIRA DE GOIAS	SV12116679	DAIA S2	12/12/2020 07:01	12/12/2020 14:28	12/12/2020 07:01	12/12/2020 14:28	7,44	16	118,98	CHI
20201264586	SANTO ANTONIO DO DESCOBERTO	SN124017011D	ALEXANIA	12/12/2020 07:03	12/12/2020 14:33	12/12/2020 07:03	12/12/2020 12:44	5,69	23	130,76	CHI
20201264586	SANTO ANTONIO DO DESCOBERTO	SN124017011D	ALEXANIA	12/12/2020 07:03	12/12/2020 14:33	12/12/2020 07:03	12/12/2020 14:33	7,50	57	427,77	CHI
20201264589	MOSSAMEDES	MD21022016	ITABERAI S2	12/12/2020 07:03	12/12/2020 10:21	12/12/2020 07:03	12/12/2020 10:21	3,29	1	3,29	CHI
20201265337	INDIARA	IY12010814	EDEIA	12/12/2020 07:04	14/12/2020 21:16	12/12/2020 07:04	12/12/2020 23:12	16,14	10	161,42	CHI
20201265337	INDIARA	IY12010814	EDEIA	12/12/2020 07:04	14/12/2020 21:16	12/12/2020 23:14	14/12/2020 21:16	46,03	10	460,26	CHI
20201264601	SAO DOMINGOS	SD12302843	SAO DOMINGOS	12/12/2020 07:06	12/12/2020 10:34	12/12/2020 07:06	12/12/2020 10:34	3,46	5	17,29	CHI
20201264605	VILA PROPICIO	10002474989	GOIANESIA S1	12/12/2020 07:07	13/12/2020 13:30	12/12/2020 07:07	13/12/2020 13:30	30,38	1	30,38	CHI
20201264909	RIO VERDE	CP12000012	CAIAPONIA	12/12/2020 07:07	12/12/2020 10:21	12/12/2020 07:07	12/12/2020 10:21	3,22	1	3,22	CHI
20201264909	JATAI	CP12000012	CAIAPONIA	12/12/2020 07:07	12/12/2020 10:21	12/12/2020 07:07	12/12/2020 10:21	3,22	2	6,45	CHI
20201264909	CAIAPONIA	CP12000012	CAIAPONIA	12/12/2020 07:07	12/12/2020 10:21	12/12/2020 07:07	12/12/2020 10:21	3,22	53	170,81	CHI
20201264682	RIO VERDE	RV12301462	ACREUNA	12/12/2020 07:09	12/12/2020 09:44	12/12/2020 07:09	12/12/2020 09:44	2,57	16	41,17	CHI
20201264682	SANTO ANTONIO DA BARRA	RV12301462	ACREUNA	12/12/2020 07:09	12/12/2020 09:44	12/12/2020 07:09	12/12/2020 09:44	2,57	1	2,57	CHI
20201264935	FORMOSA	FA12262305	ITUIQUIRA	12/12/2020 07:09	12/12/2020 08:58	12/12/2020 07:09	12/12/2020 08:58	1,81	658	1188,79	CHI
20201265186	PIRANHAS	PH12247806	ARENOPOLIS	12/12/2020 07:09	12/12/2020 11:31	12/12/2020 07:09	12/12/2020 11:31	4,36	7	30,55	CHI
20201264626	CRIXAS	CX12394450	SERRA DO OURO	12/12/2020 07:10	12/12/2020 09:17	12/12/2020 07:10	12/12/2020 09:17	2,12	12	25,40	CHI
20201264641	MORRINHOS	MR12133255	MORRINHOS	12/12/2020 07:11	12/12/2020 08:14	12/12/2020 07:11	12/12/2020 08:14	1,04	12	12,54	CHI
20201264632	JARAGUA	JA12084575	JARAGUA	12/12/2020 07:12	12/12/2020 14:06	12/12/2020 07:12	12/12/2020 14:06	6,90	5	34,50	CHI
20201264633	DIORAMA	DI21135468	IPORAGA	12/12/2020 07:12	12/12/2020 10:08	12/12/2020 07:12	12/12/2020 10:08	2,93	1	2,93	CHI
20201264635	ARAGOIANIA	HD12000067	INDEPENDENCIA S1	12/12/2020 07:12	12/12/2020 10:25	12/12/2020 07:12	12/12/2020 10:25	3,21	5	16,04	CHI
20201264635	HIDROLANDIA	HD12000067	INDEPENDENCIA S1	12/12/2020 07:12	12/12/2020 10:25	12/12/2020 07:12	12/12/2020 10:25	3,21	11	35,29	CHI
20201264639	TRINDADE	TR32055832	TRINDADE	12/12/2020 07:12	12/12/2020 09:50	12/12/2020 07:12	12/12/2020 09:50	2,62	3	7,87	CHI
20201264869	GOIAS	GS12307625	GOIAS	12/12/2020 07:12	12/12/2020 18:17	12/12/2020 07:12	12/12/2020 18:17	11,08	5	55,39	CHI
20201264651	IACIARA	IA12302645	IACIARA S2	12/12/2020 07:14	12/12/2020 08:32	12/12/2020 07:14	12/12/2020 08:32	1,29	1	1,29	CHI
20201265149	MINEIROS	MY12202613RE	PARQUE DAS EMAS	12/12/2020 07:14	12/12/2020 16:38	12/12/2020 07:14	12/12/2020 16:38	9,40	10	93,96	CHI
20201264653	CAIAPONIA	RV12030683	MONTIVIDIU T	12/12/2020 07:15	12/12/2020 10:02	12/12/2020 07:15	12/12/2020 10:02	2,78	212	589,36	CHI
20201264653	RIO VERDE	RV12030683	MONTIVIDIU T	12/12/2020 07:15	12/12/2020 10:02	12/12/2020 07:15	12/12/2020 10:02	2,78	3	8,34	CHI
20201264664	CRISTALINA	KR12348546RE	PAMPLONA	12/12/2020 07:15	12/12/2020 11:35	12/12/2020 07:15	12/12/2020 11:35	4,33	25	108,26	CHI
20201264658	NOVO BRASIL	NB12396218	JUSSARA	12/12/2020 07:16	12/12/2020 13:28	12/12/2020 07:16	12/12/2020 13:28	6,20	2	12,39	CHI
20201264675	SENADOR CANEDO	13784407	GOIANIA LESTE S2	12/12/2020 07:18	12/12/2020 08:46	12/12/2020 07:18	12/12/2020 08:46	1,47	1	1,47	CHI
20201264683	BELA VISTA DE GOIAS	BV12360000	BELA VISTA S2	12/12/2020 07:18	12/12/2020 10:08	12/12/2020 07:18	12/12/2020 10:08	2,82	2	5,64	CHI

20201264726	ITABERAÍ	IB12300330	ITABERAÍ S2	12/12/2020 07:18	12/12/2020 08:55	12/12/2020 07:18	12/12/2020 08:55	1,60	14	22,42	CHI
20201264727	AMARALINA	LC12270741	SAO MIGUEL DO ARAGUAIA	12/12/2020 07:18	12/12/2020 16:32	12/12/2020 07:18	12/12/2020 16:32	9,23	10	92,30	CHI
20201265206	PEROLANDIA	DP12260465LD	JATAÍ S1	12/12/2020 07:18	12/12/2020 11:20	12/12/2020 07:18	12/12/2020 11:20	4,03	10	40,32	CHI
20201264689	GUARANI DE GOIAS	GY12267993	IACIARA S1	12/12/2020 07:20	12/12/2020 09:57	12/12/2020 07:20	12/12/2020 09:57	2,61	51	133,32	CHI
20201264692	FORMOSA	FA12020058	ITUIQUIRA	12/12/2020 07:20	12/12/2020 14:00	12/12/2020 07:20	12/12/2020 14:00	6,66	5	33,30	CHI
20201264693	SAO MIGUEL DO ARAGUAIA	SM12000023	SAO MIGUEL DO ARAGUAIA	12/12/2020 07:20	12/12/2020 13:03	12/12/2020 07:20	12/12/2020 13:03	5,71	2	11,42	CHI
20201265420	ABADIANIA	AA12221425	ANAPOLIS UNIVERSITARIO S1	12/12/2020 07:20	12/12/2020 09:53	12/12/2020 07:20	12/12/2020 09:53	2,53	45	114,03	CHI
20201265420	GAMELEIRA DE GOIAS	AA12221425	ANAPOLIS UNIVERSITARIO S1	12/12/2020 07:20	12/12/2020 09:53	12/12/2020 07:20	12/12/2020 09:53	2,53	1	2,53	CHI
20201265529	MINACU	IH12192271	MINACU	12/12/2020 07:20	13/12/2020 04:16	12/12/2020 07:20	13/12/2020 04:16	20,93	6	125,58	CHI
20201265260	CACU	CC12035157	CACHOEIRA ALTA	12/12/2020 07:21	12/12/2020 13:40	12/12/2020 07:21	12/12/2020 13:40	6,30	10	63,01	CHI
20201264702	GOIANIA	15886682	CAMPINAS S2	12/12/2020 07:22	12/12/2020 08:32	12/12/2020 07:22	12/12/2020 08:32	1,16	1	1,16	CHI
20201264704	ANAPOLIS	10026497580	ANAPOLIS UNIVERSITARIO S2	12/12/2020 07:22	12/12/2020 08:31	12/12/2020 07:22	12/12/2020 08:31	1,14	1	1,14	CHI
20201264710	VIANOPOLIS	510030312	VIANOPOLIS	12/12/2020 07:23	12/12/2020 09:20	12/12/2020 07:23	12/12/2020 09:20	1,94	1	1,94	CHI
20201264715	CRISTALINA	KR21237872	CRISTALINA S1	12/12/2020 07:23	12/12/2020 10:51	12/12/2020 07:23	12/12/2020 10:51	3,45	1	3,45	CHI
20201264928	MUNDO NOVO DE GOIAS	MH12242017	NOVA CRIXAS	12/12/2020 07:23	12/12/2020 08:46	12/12/2020 07:23	12/12/2020 08:46	1,37	4	5,47	CHI
20201264721	AGUA FRIA DE GOIAS	TL12220968LD	SAO JOAO D ALIANCA	12/12/2020 07:24	12/12/2020 13:02	12/12/2020 07:24	12/12/2020 13:02	5,62	13	73,10	CHI
20201264723	RUBIATABA	780081560	RUBIATABA	12/12/2020 07:24	12/12/2020 16:41	12/12/2020 07:24	12/12/2020 16:41	9,27	1	9,27	CHI
20201264899	PORANGATU	MU12192418	MARA ROSA	12/12/2020 07:24	12/12/2020 14:39	12/12/2020 07:24	12/12/2020 14:39	7,24	1	7,24	CHI
20201264899	AMARALINA	MU12192418	MARA ROSA	12/12/2020 07:24	12/12/2020 14:39	12/12/2020 07:24	12/12/2020 14:39	7,24	1	7,24	CHI
20201264734	BRITANIA	BT12009771	BRITANIA	12/12/2020 07:25	12/12/2020 17:40	12/12/2020 07:25	12/12/2020 17:40	10,24	18	184,29	CHI
20201264819	IACIARA	IA12211563	IACIARA S1	12/12/2020 07:26	13/12/2020 15:41	12/12/2020 07:26	13/12/2020 15:41	32,25	9	290,23	CHI
20201264741	INHUMAS	IN21132765	INHUMAS S2	12/12/2020 07:27	12/12/2020 11:13	12/12/2020 07:27	12/12/2020 11:13	3,76	1	3,76	CHI
20201264747	URUACU	UR11384350	URUACU	12/12/2020 07:27	12/12/2020 15:24	12/12/2020 07:27	12/12/2020 15:13	7,76	31	240,51	CHI
20201264747	URUACU	UR12088772	URUACU	12/12/2020 07:27	12/12/2020 15:24	12/12/2020 15:00	12/12/2020 15:24	0,39	105	41,24	CHI
20201264758	CRISTALINA	KR12118520	PAMPLONA	12/12/2020 07:30	12/12/2020 11:10	12/12/2020 07:30	12/12/2020 11:10	3,66	2	7,31	CHI
20201264765	ITAPURANGA	IK21300201	ITAPURANGA	12/12/2020 07:31	12/12/2020 11:37	12/12/2020 07:31	12/12/2020 11:37	4,08	2	8,17	CHI
20201264773	CAIAPONIA	CP12342197	CAIAPONIA	12/12/2020 07:32	12/12/2020 16:59	12/12/2020 07:32	12/12/2020 16:59	9,44	2	18,87	CHI
20201265344	JATAÍ	JT11337011	JATAÍ S2	12/12/2020 07:32	12/12/2020 10:12	12/12/2020 07:32	12/12/2020 10:12	2,66	130	346,09	CHI
20201264777	TRINDADE	TR21365667	TRINDADE	12/12/2020 07:33	12/12/2020 09:43	12/12/2020 07:33	12/12/2020 09:43	2,16	2	4,31	CHI
20201265005	ITUMBIARA	IT12000308RE	PARANAIBA	12/12/2020 07:33	13/12/2020 07:34	12/12/2020 07:33	13/12/2020 07:34	24,01	49	1176,41	CHI
20201264783	CUMARI	CY12281463	CATALAO S1	12/12/2020 07:34	12/12/2020 10:58	12/12/2020 07:34	12/12/2020 10:58	3,40	4	13,59	CHI
20201264908	SANTA RITA DO ARAGUAIA	SU12374375	SANTA RITA DO ARAGUAIA	12/12/2020 07:34	12/12/2020 12:43	12/12/2020 07:34	12/12/2020 12:43	5,15	6	30,88	CHI
20201264908	BURITINOPOLIS	SU12374375	SANTA RITA DO ARAGUAIA	12/12/2020 07:34	12/12/2020 12:43	12/12/2020 07:34	12/12/2020 12:43	5,15	1	5,15	CHI
20201265077	VICENTINOPOLIS	VI11128634	VICENTINOPOLIS	12/12/2020 07:34	13/12/2020 02:54	12/12/2020 07:34	13/12/2020 02:54	19,33	153	2957,45	CHI
20201264792	RIO VERDE	RV12247600	CACHOEIRA ALTA	12/12/2020 07:35	12/12/2020 12:40	12/12/2020 07:35	12/12/2020 12:40	5,08	6	30,50	CHI
20201264794	MUTUNOPOLIS	MU21143698	MARA ROSA	12/12/2020 07:35	12/12/2020 18:37	12/12/2020 07:35	12/12/2020 18:37	11,03	1	11,03	CHI
20201265285	CRISTALINA	KR12162511	CRISTALINA S2	12/12/2020 07:36	12/12/2020 12:19	12/12/2020 07:36	12/12/2020 12:19	4,71	9	42,43	CHI
20201264805	INHUMAS	IN11168391	INHUMAS S2	12/12/2020 07:37	12/12/2020 10:56	12/12/2020 07:37	12/12/2020 10:56	3,32	134	444,36	CHI
20201264806	PADRE BERNARDO	PB21273081	PADRE BERNARDO	12/12/2020 07:37	12/12/2020 09:35	12/12/2020 07:37	12/12/2020 09:35	1,97	1	1,97	CHI
20201264809	PALESTINA DE GOIAS	3370008073	PALESTINA	12/12/2020 07:37	12/12/2020 10:41	12/12/2020 07:37	12/12/2020 10:41	3,06	1	3,06	CHI
20201264816	FLORES DE GOIAS	FB21419115	FLORES DE GOIAS	12/12/2020 07:37	12/12/2020 15:21	12/12/2020 07:37	12/12/2020 15:21	7,72	1	7,72	CHI
20201265167	MUTUNOPOLIS	MU12354548	MARA ROSA	12/12/2020 07:37	12/12/2020 14:42	12/12/2020 07:37	12/12/2020 14:42	7,07	2	14,14	CHI
20201264820	ALTO PARAISO DE GOIAS	BF21129910	FLORES DE GOIAS	12/12/2020 07:38	12/12/2020 08:30	12/12/2020 07:38	12/12/2020 08:30	0,85	1	0,85	CHI
20201264822	APARECIDA DE GOIANIA	11513287	INDEPENDENCIA S2	12/12/2020 07:38	12/12/2020 09:12	12/12/2020 07:38	12/12/2020 09:12	1,55	1	1,55	CHI
20201264823	PADRE BERNARDO	PB12376755	PADRE BERNARDO	12/12/2020 07:38	12/12/2020 12:03	12/12/2020 07:38	12/12/2020 12:03	4,40	2	8,80	CHI
20201264834	PILAR DE GOIAS	GG21372473	SANTA TEREZINHA	12/12/2020 07:40	12/12/2020 12:47	12/12/2020 07:40	12/12/2020 12:47	5,10	1	5,10	CHI
20201264872	PIRANHAS	PH12355231	PIRANHAS	12/12/2020 07:40	12/12/2020 13:28	12/12/2020 07:40	12/12/2020 13:28	5,79	11	63,71	CHI
20201269433	MINEIROS	MY12336398RE	PARQUE DAS EMAS	12/12/2020 07:40	13/12/2020 00:20	12/12/2020 07:40	13/12/2020 00:20	16,66	26	433,07	CHI
20201264841	BOM JARDIM DE GOIAS	BM12064233	BOM JARDIM	12/12/2020 07:41	12/12/2020 11:18	12/12/2020 07:41	12/12/2020 11:18	3,61	6	21,65	CHI
20201264981	PIRANHAS	PH12380983	PIRANHAS	12/12/2020 07:41	12/12/2020 20:03	12/12/2020 07:41	12/12/2020 20:03	12,36	6	74,17	CHI
20201264843	GOIANDIRA	GD12127552	CATALAO S1	12/12/2020 07:42	12/12/2020 10:50	12/12/2020 07:42	12/12/2020 10:50	3,13	4	12,53	CHI

20201264849	FIRMINOPOLIS	FR12323489	FIRMINOPOLIS S2	12/12/2020 07:42	12/12/2020 12:39	12/12/2020 07:42	12/12/2020 12:39	4,94	1	4,94	CHI
20201264852	JARAGUA	10014849745	JARAGUA	12/12/2020 07:43	12/12/2020 17:09	12/12/2020 07:43	12/12/2020 17:09	9,43	1	9,43	CHI
20201266325	PLANALTINA	TL12320532	SAO JOAO D ALIANCA	12/12/2020 07:43	12/12/2020 17:58	12/12/2020 07:43	12/12/2020 17:58	10,25	2	20,49	CHI
20201266656	COCALZINHO DE GOIAS	ZN12351596	COCALZINHO	12/12/2020 07:43	12/12/2020 21:55	12/12/2020 07:43	12/12/2020 21:55	14,20	2	28,39	CHI
20201264860	ITUMBIARA	10024488591	ITUMBIARA VELHA S1	12/12/2020 07:44	12/12/2020 18:16	12/12/2020 07:44	12/12/2020 18:16	10,52	1	10,52	CHI
20201266748	CRISTALINA	KR12133541LD	CRISTALINA S1	12/12/2020 07:44	12/12/2020 17:04	12/12/2020 07:44	12/12/2020 17:04	9,33	20	186,63	CHI
20201264961	CIDADE OCIDENTAL	LZ12086008	MARAJOARA	12/12/2020 07:45	12/12/2020 09:44	12/12/2020 07:45	12/12/2020 09:44	1,97	2	3,94	CHI
20201264866	GOIANIA	GN12219050	NEROPOLIS S2	12/12/2020 07:46	12/12/2020 09:32	12/12/2020 07:46	12/12/2020 09:32	1,76	2	3,52	CHI
20201264866	NEROPOLIS	GN12219050	NEROPOLIS S2	12/12/2020 07:46	12/12/2020 09:32	12/12/2020 07:46	12/12/2020 09:32	1,76	6	10,55	CHI
20201264866	SANTO ANTONIO DE GOIAS	GN12219050	NEROPOLIS S2	12/12/2020 07:46	12/12/2020 09:32	12/12/2020 07:46	12/12/2020 09:32	1,76	28	49,24	CHI
20201264949	ARENOPOLIS	AY12231099	ARENOPOLIS	12/12/2020 07:46	12/12/2020 10:45	12/12/2020 07:46	12/12/2020 10:45	2,97	31	92,08	CHI
20201264877	MONTIVIDIU	MV21200179	MONTIVIDIU T	12/12/2020 07:48	12/12/2020 10:50	12/12/2020 07:48	12/12/2020 10:50	3,03	1	3,03	CHI
20201264887	GOIANIRA	390106458	MEIA PONTE	12/12/2020 07:49	12/12/2020 10:42	12/12/2020 07:49	12/12/2020 10:42	2,87	1	2,87	CHI
20201264894	TROMBAS	TB12288317	PORANGATU	12/12/2020 07:50	12/12/2020 12:37	12/12/2020 07:50	12/12/2020 12:37	4,77	6	28,61	CHI
20201265348	CATALAO	CT12010458	CATALAO S2	12/12/2020 07:50	12/12/2020 09:31	12/12/2020 07:50	12/12/2020 09:31	1,68	7	11,73	CHI
20201265348	CUMARI	CT12010458	CATALAO S2	12/12/2020 07:50	12/12/2020 09:31	12/12/2020 07:50	12/12/2020 09:31	1,68	8	13,40	CHI
20201264902	JATAI	JT12184203	JATAI S2	12/12/2020 07:52	12/12/2020 12:31	12/12/2020 07:52	12/12/2020 12:31	4,65	1	4,65	CHI
20201264903	FORMOSA	FA12042025	ITUIQUIRA	12/12/2020 07:52	12/12/2020 11:30	12/12/2020 07:52	12/12/2020 11:30	3,63	3	10,89	CHI
20201264904	SENADOR CANEDO	SW21083094	GOIANIA LESTE S3	12/12/2020 07:52	12/12/2020 09:31	12/12/2020 07:52	12/12/2020 09:31	1,65	1	1,65	CHI
20201264906	ITAJA	IJ12200688	ITAJA S2	12/12/2020 07:52	12/12/2020 09:39	12/12/2020 07:52	12/12/2020 09:39	1,77	2	3,55	CHI
20201264910	CAMPOS VERDES	VD12380750	SANTA TEREZINHA	12/12/2020 07:52	12/12/2020 13:26	12/12/2020 07:52	12/12/2020 13:26	5,55	3	16,66	CHI
20201264917	CAMPINACU	UC12239754	PORANGATU	12/12/2020 07:54	12/12/2020 10:43	12/12/2020 07:54	12/12/2020 10:43	2,82	4	11,27	CHI
20201264919	MORRINHOS	PJ12105736	MORRINHOS	12/12/2020 07:54	12/12/2020 09:09	12/12/2020 07:54	12/12/2020 09:09	1,25	1	1,25	CHI
20201264919	PIRACANJUBA	PJ12105736	MORRINHOS	12/12/2020 07:54	12/12/2020 09:09	12/12/2020 07:54	12/12/2020 09:09	1,25	3	3,74	CHI
20201264926	ITAPACI	IW12401689	ITAPACI	12/12/2020 07:54	12/12/2020 10:53	12/12/2020 07:54	12/12/2020 10:53	2,97	2	5,94	CHI
20201264938	VALPARAISO DE GOIAS	2860229043	PACAEMBU S1	12/12/2020 07:56	12/12/2020 10:02	12/12/2020 07:56	12/12/2020 10:02	2,10	1	2,10	CHI
20201264942	CAIAPONIA	CP12247446	PALESTINA	12/12/2020 07:57	12/12/2020 15:22	12/12/2020 07:57	12/12/2020 15:22	7,42	3	22,25	CHI
20201264947	ALTO PARAISO DE GOIAS	BF12072316	SAO JOAO D ALIANCA	12/12/2020 07:58	12/12/2020 10:24	12/12/2020 07:58	12/12/2020 10:24	2,43	11	26,76	CHI
20201264954	VILA PROPICIO	NP12235931	GOIANESIA S2	12/12/2020 07:58	12/12/2020 13:18	12/12/2020 07:58	12/12/2020 13:03	5,07	2	10,15	CHI
20201264954	VILA PROPICIO	GE12325266	GOIANESIA S2	12/12/2020 07:58	12/12/2020 13:18	12/12/2020 12:59	12/12/2020 13:18	0,31	1	0,31	CHI
20201265027	CACU	CC11000019	CACHOEIRA ALTA	12/12/2020 07:58	12/12/2020 08:58	12/12/2020 07:58	12/12/2020 08:58	1,00	163	162,28	CHI
20201265068	GUARINOS	IW12281203	ITAPACI	12/12/2020 07:59	12/12/2020 15:35	12/12/2020 07:59	12/12/2020 15:35	7,60	5	38,00	CHI
20201265068	ITAPACI	IW12281203	ITAPACI	12/12/2020 07:59	12/12/2020 15:35	12/12/2020 07:59	12/12/2020 15:35	7,60	2	15,20	CHI
20201264964	SANTA RITA DO ARAGUAIA	SU21301980	SANTA RITA DO ARAGUAIA	12/12/2020 08:00	12/12/2020 22:17	12/12/2020 08:00	12/12/2020 22:17	14,28	1	14,28	CHI
20201264969	ANICUNS	AC12391421	ANICUNS	12/12/2020 08:01	12/12/2020 14:35	12/12/2020 08:01	12/12/2020 14:35	6,56	3	19,68	CHI
20201264971	SAO DOMINGOS	SD12428597	SAO DOMINGOS	12/12/2020 08:01	12/12/2020 10:38	12/12/2020 08:01	12/12/2020 10:38	2,60	1	2,60	CHI
20201264975	SANTA CRUZ DE GOIAS	10003368740	PIRES DO RIO S2	12/12/2020 08:02	12/12/2020 12:09	12/12/2020 08:02	12/12/2020 12:09	4,12	1	4,12	CHI
20201264982	ACREUNA	EU21239463	ACREUNA	12/12/2020 08:02	12/12/2020 09:30	12/12/2020 08:02	12/12/2020 09:30	1,45	1	1,45	CHI
20201266241	RIO VERDE	QI12279632	QUIRINOPOLIS	12/12/2020 08:02	12/12/2020 15:00	12/12/2020 08:02	12/12/2020 15:00	6,96	19	132,17	CHI
20201266241	QUIRINOPOLIS	QI12279632	QUIRINOPOLIS	12/12/2020 08:02	12/12/2020 15:00	12/12/2020 08:02	12/12/2020 15:00	6,96	2	13,91	CHI
20201266241	CACHOEIRA ALTA	QI12279632	QUIRINOPOLIS	12/12/2020 08:02	12/12/2020 15:00	12/12/2020 08:02	12/12/2020 15:00	6,96	9	62,60	CHI
20201264984	ANICUNS	AC12323615	ANICUNS	12/12/2020 08:03	12/12/2020 11:18	12/12/2020 08:03	12/12/2020 11:18	3,25	5	16,24	CHI
20201264989	SAO FRANCISCO DE GOIAS	PV21185061	SAO FRANCISCO DE GOIAS	12/12/2020 08:03	12/12/2020 16:10	12/12/2020 08:03	12/12/2020 16:10	8,11	1	8,11	CHI
20201264991	MONTE ALEGRE DE GOIAS	MA12238057	SAO DOMINGOS	12/12/2020 08:03	12/12/2020 10:02	12/12/2020 08:03	12/12/2020 10:02	1,97	31	61,02	CHI
20201265054	RIO VERDE	RV12018096	SANTA HELENA S1	12/12/2020 08:03	12/12/2020 10:14	12/12/2020 08:03	12/12/2020 10:14	2,18	2	4,37	CHI
20201265000	ITAGUARI	IC12035368	ITABERAI S1	12/12/2020 08:04	12/12/2020 14:11	12/12/2020 08:04	12/12/2020 14:11	6,11	27	164,87	CHI
20201265000	JARAGUA	IC12035368	ITABERAI S1	12/12/2020 08:04	12/12/2020 14:11	12/12/2020 08:04	12/12/2020 14:11	6,11	9	54,96	CHI
20201265071	SANCLERLANDIA	MD12057741	FIRMINOPOLIS S2	12/12/2020 08:04	12/12/2020 08:59	12/12/2020 08:04	12/12/2020 08:59	0,91	1	0,91	CHI
20201265071	MOSSAMEDES	MD12057741	FIRMINOPOLIS S2	12/12/2020 08:04	12/12/2020 08:59	12/12/2020 08:04	12/12/2020 08:59	0,91	18	16,47	CHI
20201265898	MINACU	IH12181712	MINACU	12/12/2020 08:04	13/12/2020 14:52	12/12/2020 08:04	13/12/2020 14:52	30,78	81	2493,52	CHI
20201266192	PETROLINA DE GOIAS	PG12011518	PETROLINA	12/12/2020 08:04	12/12/2020 15:57	12/12/2020 08:04	12/12/2020 15:57	7,87	10	78,72	CHI

20201265006	AGUA FRIA DE GOIAS	TL21218618	SAO JOAO D ALIANCA	12/12/2020 08:05	12/12/2020 18:41	12/12/2020 08:05	12/12/2020 18:41	10,60	1	10,60	CHI
20201265009	JATAI	JT11166030	JATAI S2	12/12/2020 08:05	12/12/2020 10:56	12/12/2020 08:05	12/12/2020 10:56	2,85	123	350,04	CHI
20201265011	APARECIDA DE GOIANIA	11924846	INDEPENDENCIA S2	12/12/2020 08:05	12/12/2020 14:51	12/12/2020 08:05	12/12/2020 14:51	6,76	1	6,76	CHI
20201265013	CORUMBA DE GOIAS	AX12061914	CORUMBA	12/12/2020 08:05	12/12/2020 12:55	12/12/2020 08:05	12/12/2020 12:55	4,82	2	9,64	CHI
20201265014	NIQUELANDIA	NQ12292141LD	NIQUELANDIA SUBTRANSMISSAO	12/12/2020 08:05	12/12/2020 10:14	12/12/2020 08:05	12/12/2020 10:14	2,14	20	42,76	CHI
20201265016	NOVO GAMA	2460014175	PACAEMBU S1	12/12/2020 08:05	12/12/2020 10:41	12/12/2020 08:05	12/12/2020 10:41	2,59	1	2,59	CHI
20201265154	QUIRINOPOLIS	QI12191652	CACHOEIRA ALTA	12/12/2020 08:05	12/12/2020 17:38	12/12/2020 08:05	12/12/2020 17:38	9,55	9	85,92	CHI
20201265154	CACHOEIRA ALTA	QI12191652	CACHOEIRA ALTA	12/12/2020 08:05	12/12/2020 17:38	12/12/2020 08:05	12/12/2020 17:38	9,55	3	28,64	CHI
20201266145	CAMPINACU	UC12269890	MARA ROSA	12/12/2020 08:05	12/12/2020 23:57	12/12/2020 08:05	12/12/2020 23:57	15,86	34	539,14	CHI
20201265021	ANAPOLIS	OV21223924	NEROPOLIS S1	12/12/2020 08:06	12/12/2020 12:29	12/12/2020 08:06	12/12/2020 12:29	4,38	1	4,38	CHI
20201265028	PARAUNA	PU21417228	PARAUNA	12/12/2020 08:07	12/12/2020 11:53	12/12/2020 08:07	12/12/2020 11:53	3,77	1	3,77	CHI
20201265030	PARAUNA	PU12219751	MONTIVIDIU T	12/12/2020 08:07	12/12/2020 15:17	12/12/2020 08:07	12/12/2020 15:17	7,16	37	264,92	CHI
20201265032	BURITI ALEGRE	420010841	ALTO BURITI	12/12/2020 08:08	12/12/2020 17:49	12/12/2020 08:08	12/12/2020 17:49	9,68	1	9,68	CHI
20201265035	PARAUNA	PU21259245	PARAUNA	12/12/2020 08:08	12/12/2020 13:04	12/12/2020 08:08	12/12/2020 13:04	4,93	1	4,93	CHI
20201265037	VIANOPOLIS	VN13375193	VIANOPOLIS	12/12/2020 08:08	12/12/2020 14:52	12/12/2020 09:50	12/12/2020 14:52	5,03	13	65,45	CHI
20201265042	SAO JOAO D ALIANCA	JL21290390	SAO JOAO D ALIANCA	12/12/2020 08:09	12/12/2020 21:08	12/12/2020 08:09	12/12/2020 21:08	12,98	1	12,98	CHI
20201265044	CAMPO LIMPO	AN21055362	NEROPOLIS S1	12/12/2020 08:09	12/12/2020 14:14	12/12/2020 08:09	12/12/2020 14:14	6,07	6	36,44	CHI
20201265890	PIRACANJUBA	PJ12043108	PIRACANJUBA	12/12/2020 08:09	12/12/2020 11:37	12/12/2020 08:09	12/12/2020 11:37	3,45	12	41,44	CHI
20201265051	MUTUNOPOLIS	MU21132262	MARA ROSA	12/12/2020 08:10	12/12/2020 20:51	12/12/2020 08:10	12/12/2020 20:51	12,68	1	12,68	CHI
20201265530	CORUMBAIBA	CI12064619	VILA CORUMBA	12/12/2020 08:10	12/12/2020 13:10	12/12/2020 08:10	12/12/2020 13:10	4,99	38	189,65	CHI
20201265057	RIO VERDE	RV13219431	CABRIUVA S2	12/12/2020 08:11	13/12/2020 01:44	12/12/2020 19:58	12/12/2020 20:16	0,30	8	2,39	CHI
20201265057	RIO VERDE	RV21271513	CABRIUVA S2	12/12/2020 08:11	13/12/2020 01:44	12/12/2020 08:11	13/12/2020 01:29	17,30	1	17,30	CHI
20201265057	RIO VERDE	RV13271386	CABRIUVA S2	12/12/2020 08:11	13/12/2020 01:44	12/12/2020 19:58	13/12/2020 01:44	5,77	10	57,73	CHI
20201265136	JATAI	JT12303837	JATAI S1	12/12/2020 08:12	12/12/2020 11:18	12/12/2020 08:12	12/12/2020 11:18	3,10	26	80,57	CHI
20201265574	PIRES DO RIO	PR12000096RE	PIRES DO RIO S1	12/12/2020 08:12	12/12/2020 09:50	12/12/2020 08:12	12/12/2020 09:50	1,63	22	35,80	CHI
20201265574	PALMELO	PR12000096RE	PIRES DO RIO S1	12/12/2020 08:12	12/12/2020 09:50	12/12/2020 08:12	12/12/2020 09:50	1,63	6	9,76	CHI
20201265064	LUZANIA	LZ12383015	VIANOPOLIS	12/12/2020 08:13	12/12/2020 11:12	12/12/2020 08:13	12/12/2020 11:12	2,98	50	149,17	CHI
20201265095	AGUAS LINDAS DE GOIAS	4830152504	AGUAS LINDAS DE GOIAS S2	12/12/2020 08:17	12/12/2020 10:09	12/12/2020 08:17	12/12/2020 10:09	1,87	1	1,87	CHI
20201265096	APARECIDA DE GOIANIA	200568437	ANHANGUERA	12/12/2020 08:17	12/12/2020 10:10	12/12/2020 08:17	12/12/2020 10:10	1,88	1	1,88	CHI
20201265100	TRINDADE	40268100	GOYA S2	12/12/2020 08:17	12/12/2020 10:06	12/12/2020 08:17	12/12/2020 10:06	1,81	1	1,81	CHI
20201265102	PONTALINA	PK21074316	VICENTINOPOLIS	12/12/2020 08:17	12/12/2020 11:13	12/12/2020 08:17	12/12/2020 11:13	2,92	1	2,92	CHI
20201265105	ARAGUAPAZ	AZ12404519	MOZARLANDIA	12/12/2020 08:18	12/12/2020 16:30	12/12/2020 08:18	12/12/2020 16:30	8,20	10	81,98	CHI
20201265109	APARECIDA DE GOIANIA	10010929078	ATLANTICO S2	12/12/2020 08:18	12/12/2020 13:19	12/12/2020 08:18	12/12/2020 13:19	5,01	1	5,01	CHI
20201265110	FORMOSA	FA21153691	ITUIQUIRA	12/12/2020 08:18	12/12/2020 10:28	12/12/2020 08:18	12/12/2020 10:28	2,16	1	2,16	CHI
20201265113	MINACU	IH12325778	MINACU	12/12/2020 08:18	13/12/2020 11:03	12/12/2020 08:18	13/12/2020 11:03	26,74	5	133,68	CHI
20201265133	SAO FRANCISCO DE GOIAS	SF12278877	SAO FRANCISCO DE GOIAS	12/12/2020 08:18	12/12/2020 13:16	12/12/2020 08:18	12/12/2020 13:16	4,96	7	34,71	CHI
20201265117	CATURAI	CK21018945	INHUMAS S1	12/12/2020 08:19	12/12/2020 15:12	12/12/2020 08:19	12/12/2020 15:12	6,88	1	6,88	CHI
20201265124	APARECIDA DE GOIANIA	16764638	INDEPENDENCIA S1	12/12/2020 08:20	12/12/2020 14:35	12/12/2020 08:20	12/12/2020 14:35	6,23	1	6,23	CHI
20201265131	GOIANIA	10889991	GOIANIA LESTE S1	12/12/2020 08:22	12/12/2020 12:32	12/12/2020 08:22	12/12/2020 12:32	4,16	1	4,16	CHI
20201265132	PADRE BERNARDO	PB12216115	PADRE BERNARDO	12/12/2020 08:22	12/12/2020 16:25	12/12/2020 08:22	12/12/2020 16:25	8,04	15	120,58	CHI
20201265134	RIO VERDE	630164605	RIO VERDE S2	12/12/2020 08:22	12/12/2020 11:15	12/12/2020 08:22	12/12/2020 11:15	2,87	1	2,87	CHI
20201265135	CATALAO	CT11037436	CATALAO S2	12/12/2020 08:23	12/12/2020 10:41	12/12/2020 08:23	12/12/2020 10:41	2,30	130	299,00	CHI
20201266249	CORUMBA DE GOIAS	CB12243944	CORUMBA	12/12/2020 08:23	13/12/2020 12:45	12/12/2020 08:23	13/12/2020 12:45	28,36	4	113,46	CHI
20201267811	GOIANESIA	GE12382867	GOIANESIA S1	12/12/2020 08:23	13/12/2020 18:50	12/12/2020 08:23	13/12/2020 18:50	34,44	4	137,77	CHI
20201265144	MORRINHOS	MR12098617	MORRINHOS	12/12/2020 08:24	12/12/2020 12:54	12/12/2020 08:24	12/12/2020 12:54	4,50	5	22,49	CHI
20201265145	GOIATUBA	140067980	GOIATUBA S2	12/12/2020 08:24	12/12/2020 11:14	12/12/2020 08:24	12/12/2020 11:14	2,83	1	2,83	CHI
20201265146	COALZINHO DE GOIAS	LA12198642	AGUAS LINDAS DE GOIAS S1	12/12/2020 08:24	12/12/2020 09:55	12/12/2020 08:24	12/12/2020 09:55	1,51	2	3,02	CHI
20201265146	AGUAS LINDAS DE GOIAS	LA12198642	AGUAS LINDAS DE GOIAS S1	12/12/2020 08:24	12/12/2020 09:55	12/12/2020 08:24	12/12/2020 09:55	1,51	2	3,02	CHI
20201265153	POSSE	MB12376647	IACIARA S2	12/12/2020 08:25	12/12/2020 11:28	12/12/2020 08:25	12/12/2020 11:28	3,05	1	3,05	CHI
20201265479	SANTA FE DE GOIAS	RN12378892	BRITANIA	12/12/2020 08:25	12/12/2020 23:06	12/12/2020 08:25	12/12/2020 23:06	14,68	19	278,98	CHI
20201265162	URUACU	UR11395661	URUACU	12/12/2020 08:26	12/12/2020 10:51	12/12/2020 08:26	12/12/2020 10:51	2,40	1	2,40	CHI

20201265165	PORANGATU	PO12378923	PORANGATU	12/12/2020 08:27	12/12/2020 10:01	12/12/2020 08:27	12/12/2020 10:01	1,56	2	3,13	CHI
20201265169	BURITI ALEGRE	BG12000161	ITUMBIARA VELHA S2	12/12/2020 08:27	12/12/2020 17:32	12/12/2020 08:27	12/12/2020 17:32	9,07	2	18,15	CHI
20201265171	CAVALCANTE	CJ12346073	MINACU	12/12/2020 08:28	12/12/2020 22:23	12/12/2020 08:28	12/12/2020 22:23	13,91	129	1794,68	CHI
20201265175	PONTALINA	210011634	PONTALINA	12/12/2020 08:28	12/12/2020 12:32	12/12/2020 08:28	12/12/2020 12:32	4,06	1	4,06	CHI
20201265176	CRIXAS	20078745	RUBIATABA	12/12/2020 08:28	12/12/2020 16:35	12/12/2020 08:28	12/12/2020 16:35	8,10	5	40,52	CHI
20201265178	MAMBAI	10002332530	IACIARA S2	12/12/2020 08:28	12/12/2020 09:26	12/12/2020 08:28	12/12/2020 09:26	0,95	1	0,95	CHI
20201265183	GOIAS	GS21234132	GOIAS	12/12/2020 08:30	12/12/2020 17:08	12/12/2020 08:30	12/12/2020 17:08	8,63	1	8,63	CHI
20201265185	FORMOSA	FA12242845	ITUIQUIRA	12/12/2020 08:30	12/12/2020 12:25	12/12/2020 08:30	12/12/2020 12:25	3,91	4	15,63	CHI
20201265187	URUACU	UR12340206	CAMPINORTE	12/12/2020 08:30	12/12/2020 11:42	12/12/2020 08:30	12/12/2020 11:42	3,19	1	3,19	CHI
20201265188	NOVA VENEZA	10025704310	INHUMAS S1	12/12/2020 08:30	12/12/2020 15:09	12/12/2020 08:30	12/12/2020 15:09	6,64	1	6,64	CHI
20201265191	NOVA IGUACU DE GOIAS	UR12407359	URUACU	12/12/2020 08:31	13/12/2020 09:21	12/12/2020 08:31	13/12/2020 09:21	24,83	5	124,15	CHI
20201265191	URUACU	UR12407359	URUACU	12/12/2020 08:31	13/12/2020 09:21	12/12/2020 08:31	13/12/2020 09:21	24,83	3	74,49	CHI
20201265195	GOIATUBA	GT21247744	BOM JESUS DE GOIAS	12/12/2020 08:31	12/12/2020 19:14	12/12/2020 08:31	12/12/2020 19:14	10,71	3	32,12	CHI
20201265204	MINACU	IH21236207	MINACU	12/12/2020 08:32	12/12/2020 21:57	12/12/2020 08:32	12/12/2020 21:57	13,41	2	26,82	CHI
20201265205	ITAUUCU	IX11000008	INHUMAS S1	12/12/2020 08:32	12/12/2020 10:37	12/12/2020 08:32	12/12/2020 10:37	2,08	103	213,84	CHI
20201265207	CACHOEIRA ALTA	CA21036998	CACHOEIRA ALTA	12/12/2020 08:32	12/12/2020 14:08	12/12/2020 08:32	12/12/2020 14:08	5,60	1	5,60	CHI
20201265209	INHUMAS	10014093152	INHUMAS S2	12/12/2020 08:32	12/12/2020 13:34	12/12/2020 08:32	12/12/2020 13:34	5,02	1	5,02	CHI
20201266952	GOIANESIA	GE11091177	GOIANESIA S2	12/12/2020 08:32	12/12/2020 16:47	12/12/2020 08:32	12/12/2020 16:47	8,25	146	1204,46	CHI
20201265217	HIDROLANDIA	HD21092164	CEPAIGO S2	12/12/2020 08:33	12/12/2020 09:52	12/12/2020 08:33	12/12/2020 09:52	1,30	2	2,61	CHI
20201265367	PARAUNA	PU12083052	ACREUNA	12/12/2020 08:33	12/12/2020 14:02	12/12/2020 08:33	12/12/2020 14:02	5,48	16	87,61	CHI
20201265223	GOIANIA	14836117	MEIA PONTE	12/12/2020 08:34	12/12/2020 11:39	12/12/2020 08:34	12/12/2020 11:39	3,07	1	3,07	CHI
20201265500	RIO VERDE	RV12393335	MONTIVIDIU T	12/12/2020 08:34	12/12/2020 13:56	12/12/2020 08:34	12/12/2020 13:56	5,36	17	91,08	CHI
20201265225	CATALAO	00830204	IPAMERI	12/12/2020 08:35	12/12/2020 08:53	12/12/2020 08:35	12/12/2020 08:53	0,31	6	1,84	CHI
20201265225	CORUMBAIBA	00830204	IPAMERI	12/12/2020 08:35	12/12/2020 08:53	12/12/2020 08:35	12/12/2020 08:53	0,31	19	5,84	CHI
20201265225	CALDAS NOVAS	00830204	IPAMERI	12/12/2020 08:35	12/12/2020 08:53	12/12/2020 08:35	12/12/2020 08:53	0,31	9	2,77	CHI
20201265225	NOVA AURORA	00830204	IPAMERI	12/12/2020 08:35	12/12/2020 08:53	12/12/2020 08:35	12/12/2020 08:53	0,31	2	0,61	CHI
20201265225	GOIANDIRA	00830204	IPAMERI	12/12/2020 08:35	12/12/2020 08:53	12/12/2020 08:35	12/12/2020 08:53	0,31	6	1,84	CHI
20201265225	IPAMERI	00830204	IPAMERI	12/12/2020 08:35	12/12/2020 08:53	12/12/2020 08:35	12/12/2020 08:53	0,31	9718	2985,59	CHI
20201265225	URUTAI	00830204	IPAMERI	12/12/2020 08:35	12/12/2020 08:53	12/12/2020 08:35	12/12/2020 08:53	0,31	4	1,23	CHI
20201265237	NIQUELANDIA	NQ21232466	BARRO ALTO	12/12/2020 08:36	13/12/2020 04:36	12/12/2020 08:36	13/12/2020 04:36	20,00	1	20,00	CHI
20201265239	SILVANIA	SV12346293	VIANOPOLIS	12/12/2020 08:36	12/12/2020 20:30	12/12/2020 08:36	12/12/2020 20:30	11,89	5	59,46	CHI
20201265243	AMORINOPOLIS	AM12381023	IPORA	12/12/2020 08:36	12/12/2020 09:45	12/12/2020 08:36	12/12/2020 09:45	1,14	5	5,69	CHI
20201265249	CATURAI	CK31004763	TRINDADE	12/12/2020 08:37	12/12/2020 13:01	12/12/2020 08:37	12/12/2020 13:01	4,39	1	4,39	CHI
20201265265	SERRANOPOLIS	SX12372554	JATAI S1	12/12/2020 08:38	12/12/2020 13:26	12/12/2020 08:38	12/12/2020 13:26	4,79	9	43,15	CHI
20201265278	NOVA CRIXAS	8570012897	NOVA CRIXAS	12/12/2020 08:39	12/12/2020 19:50	12/12/2020 08:39	12/12/2020 19:50	11,18	1	11,18	CHI
20201265292	MONTES CLAROS DE GOIAS	ME12187647	IPORA	12/12/2020 08:40	12/12/2020 16:57	12/12/2020 08:40	12/12/2020 16:57	8,27	12	99,27	CHI
20201265295	SAO JOAO D ALIANCA	3840029154	SAO JOAO D ALIANCA	12/12/2020 08:41	12/12/2020 12:32	12/12/2020 08:41	12/12/2020 12:32	3,85	1	3,85	CHI
20201265570	QUIRINOPOLIS	QI12402325	QUIRINOPOLIS	12/12/2020 08:41	12/12/2020 11:52	12/12/2020 08:41	12/12/2020 11:52	3,18	15	47,67	CHI
20201265306	GOIANIA	14007642	GOIANIA LESTE S1	12/12/2020 08:42	12/12/2020 10:41	12/12/2020 08:42	12/12/2020 10:41	1,98	1	1,98	CHI
20201265312	GOIAS	GS11068545	MATRINCHA	12/12/2020 08:42	13/12/2020 10:31	12/12/2020 08:42	13/12/2020 10:31	25,80	1	25,80	CHI
20201265331	RIO VERDE	RV12207197	MONTIVIDIU T	12/12/2020 08:42	12/12/2020 11:59	12/12/2020 08:42	12/12/2020 11:59	3,27	18	58,86	CHI
20201265451	BURITI ALEGRE	BG12161876	ITUMBIARA VELHA S2	12/12/2020 08:42	12/12/2020 18:00	12/12/2020 08:42	12/12/2020 18:00	9,30	4	37,19	CHI
20201265318	NIQUELANDIA	NQ11364481	NIQUELANDIA SUBTRANSMISSAO	12/12/2020 08:43	12/12/2020 14:10	12/12/2020 08:43	12/12/2020 14:10	5,44	11	59,87	CHI
20201265321	GOIANIA	GN11078477	CAMPINAS S1	12/12/2020 08:43	12/12/2020 09:29	12/12/2020 08:43	12/12/2020 09:29	0,75	67	50,57	CHI
20201265401	GOIANIA	GN11035481	ATLANTICO S2	12/12/2020 08:43	12/12/2020 13:00	12/12/2020 08:43	12/12/2020 13:00	4,27	218	930,62	CHI
20201265524	JUSSARA	JR12396094	JUSSARA	12/12/2020 08:43	12/12/2020 11:51	12/12/2020 08:43	12/12/2020 11:51	3,12	26	81,21	CHI
20201265323	CATALAO	CT21231544	CATALAO S1	12/12/2020 08:44	12/12/2020 15:32	12/12/2020 08:44	12/12/2020 15:32	6,80	1	6,80	CHI
20201265327	MUTUNOPOLIS	MU21141659	MARA ROSA	12/12/2020 08:44	12/12/2020 12:43	12/12/2020 08:44	12/12/2020 12:43	3,98	1	3,98	CHI
20201266151	VIANOPOLIS	SQ12231379	CRISTIANOPOLIS	12/12/2020 08:44	12/12/2020 13:31	12/12/2020 08:44	12/12/2020 13:31	4,78	7	33,46	CHI
20201266151	SAO MIGUEL DO PASSA QUATRO	SQ12231379	CRISTIANOPOLIS	12/12/2020 08:44	12/12/2020 13:31	12/12/2020 08:44	12/12/2020 13:31	4,78	14	66,93	CHI
20201265341	CATALAO	8039758	CATALAO S1	12/12/2020 08:46	12/12/2020 10:55	12/12/2020 08:46	12/12/2020 10:55	2,16	5	10,78	CHI

20201265355	ALEXANIA	AX21318552	ALEXANIA	12/12/2020 08:47	12/12/2020 11:37	12/12/2020 08:47	12/12/2020 11:37	2,83	1	2,83	CHI
20201265361	SAO JOAO D ALIANCA	JL12383345	SAO JOAO D ALIANCA	12/12/2020 08:47	12/12/2020 11:23	12/12/2020 08:47	12/12/2020 11:23	2,58	5	12,92	CHI
20201265368	QUIRINOPOLIS	QI21279382	QUIRINOPOLIS	12/12/2020 08:48	13/12/2020 10:17	12/12/2020 08:48	13/12/2020 09:56	25,14	1	25,14	CHI
20201265368	QUIRINOPOLIS	QI21295193	QUIRINOPOLIS	12/12/2020 08:48	13/12/2020 10:17	12/12/2020 08:48	13/12/2020 10:17	25,48	1	25,48	CHI
20201265370	MORRINHOS	MR12273673	MORRINHOS	12/12/2020 08:48	12/12/2020 10:45	12/12/2020 08:48	12/12/2020 10:45	1,94	4	7,74	CHI
20201266087	JANDAIA	JD12008606	PALMEIRAS	12/12/2020 08:49	12/12/2020 12:10	12/12/2020 08:49	12/12/2020 12:10	3,34	82	273,65	CHI
20201266087	PARAUNA	JD12008606	PALMEIRAS	12/12/2020 08:49	12/12/2020 12:10	12/12/2020 08:49	12/12/2020 12:10	3,34	6	20,02	CHI
20201265378	GOIAS	IB21274479	ITABERAI S1	12/12/2020 08:50	12/12/2020 09:47	12/12/2020 08:50	12/12/2020 09:47	0,95	1	0,95	CHI
20201265385	CACHOEIRA ALTA	CA12071611	CACHOEIRA ALTA	12/12/2020 08:50	12/12/2020 11:38	12/12/2020 08:50	12/12/2020 11:38	2,79	19	52,94	CHI
20201265392	GOIANIA	13179809	CARAJAS S1	12/12/2020 08:51	12/12/2020 10:31	12/12/2020 08:51	12/12/2020 10:31	1,66	1	1,66	CHI
20201265661	MONTES CLAROS DE GOIAS	ME12198229	IPORA	12/12/2020 08:51	12/12/2020 15:32	12/12/2020 08:51	12/12/2020 15:32	6,67	8	53,37	CHI
20201265398	PIRACANJUBA	BV12057830	BELA VISTA S1	12/12/2020 08:52	12/12/2020 13:47	12/12/2020 08:52	12/12/2020 13:47	4,91	1	4,91	CHI
20201265657	MINEIROS	MY12296320RE	PARQUE DAS EMAS	12/12/2020 08:52	12/12/2020 16:08	12/12/2020 08:52	12/12/2020 16:08	7,26	11	79,89	CHI
20201265404	GOIANIA	GN12084316	GOIANIA LESTE S2	12/12/2020 08:53	12/12/2020 11:18	12/12/2020 08:53	12/12/2020 11:18	2,41	1	2,41	CHI
20201265404	SENADOR CANEDO	GN12084316	GOIANIA LESTE S2	12/12/2020 08:53	12/12/2020 11:18	12/12/2020 08:53	12/12/2020 11:18	2,41	2	4,83	CHI
20201265413	SIMOLANDIA	SA21246928	IACIARA S2	12/12/2020 08:54	12/12/2020 17:51	12/12/2020 08:54	12/12/2020 17:42	8,81	1	8,81	CHI
20201265413	SIMOLANDIA	SA12168085LD	IACIARA S2	12/12/2020 08:54	12/12/2020 17:51	12/12/2020 16:04	12/12/2020 17:51	1,79	39	69,87	CHI
20201265413	POSSE	SA12168085LD	IACIARA S2	12/12/2020 08:54	12/12/2020 17:51	12/12/2020 16:04	12/12/2020 17:51	1,79	14	25,08	CHI
20201265414	ITUMBIARA	CD12166368	BOM JESUS DE GOIAS	12/12/2020 08:54	13/12/2020 09:13	12/12/2020 08:54	13/12/2020 09:13	24,31	1	24,31	CHI
20201265414	CACHOEIRA DOURADA	CD12166368	BOM JESUS DE GOIAS	12/12/2020 08:54	13/12/2020 09:13	12/12/2020 08:54	13/12/2020 09:13	24,31	5	121,57	CHI
20201265416	APARECIDA DE GOIANIA	AP11329137	REAL S1	12/12/2020 08:54	12/12/2020 22:29	12/12/2020 13:24	12/12/2020 22:29	9,08	82	744,67	CHI
20201265417	MORRINHOS	MR12056739	MORRINHOS	12/12/2020 08:54	12/12/2020 13:51	12/12/2020 08:54	12/12/2020 13:51	4,94	3	14,81	CHI
20201265968	CRISTALINA	KR12304869	CRISTALINA S2	12/12/2020 08:55	12/12/2020 12:18	12/12/2020 08:55	12/12/2020 12:18	3,38	15	50,67	CHI
20201264699	ITAPIRAPUA	IU12020180LD	JUSSARA	12/12/2020 08:56	12/12/2020 13:29	12/12/2020 08:56	12/12/2020 13:29	4,54	81	368,08	CHI
20201264699	ITAPIRAPUA	IU12020180LD	JUSSARA	12/12/2020 08:56	12/12/2020 13:29	12/12/2020 11:06	12/12/2020 13:29	2,38	9	21,40	CHI
20201265427	GOIANIA	GN11077779	REAL S1	12/12/2020 08:57	12/12/2020 10:04	12/12/2020 09:42	12/12/2020 10:04	0,37	61	22,37	CHI
20201265454	QUIRINOPOLIS	QI12371291	QUIRINOPOLIS	12/12/2020 08:57	12/12/2020 16:25	12/12/2020 08:57	12/12/2020 16:25	7,46	4	29,86	CHI
20201265488	ACREUNA	EU12030223	ACREUNA	12/12/2020 08:58	12/12/2020 11:00	12/12/2020 08:58	12/12/2020 11:00	2,02	3	6,06	CHI
20201265503	ANICUNS	AC12259103	FIRMINOPOLIS S2	12/12/2020 08:58	12/12/2020 09:50	12/12/2020 08:58	12/12/2020 09:50	0,86	19	16,38	CHI
20201265739	CORUMBA DE GOIAS	AX12000109	CORUMBA	12/12/2020 08:59	12/12/2020 10:45	12/12/2020 08:59	12/12/2020 10:45	1,76	4	7,04	CHI
20201265739	ALEXANIA	AX12000109	CORUMBA	12/12/2020 08:59	12/12/2020 10:45	12/12/2020 08:59	12/12/2020 10:45	1,76	7	12,32	CHI
20201265455	CRISTALINA	KR12256292	CRISTALINA S1	12/12/2020 09:00	12/12/2020 12:02	12/12/2020 09:00	12/12/2020 12:02	3,03	224	678,72	CHI
20201265460	BELA VISTA DE GOIAS	BV21035315	BELA VISTA S1	12/12/2020 09:00	12/12/2020 10:26	12/12/2020 09:00	12/12/2020 10:26	1,42	1	1,42	CHI
20201265468	ITUMBIARA	BG21293166	ITUMBIARA VELHA S2	12/12/2020 09:00	12/12/2020 16:49	12/12/2020 09:00	12/12/2020 16:49	7,81	1	7,81	CHI
20201265465	RIO VERDE	10030945206	RIO VERDE S2	12/12/2020 09:01	12/12/2020 16:32	12/12/2020 09:01	12/12/2020 16:32	7,51	1	7,51	CHI
20201265999	JATAI	JT12105208	JATAI S1	12/12/2020 09:02	12/12/2020 12:33	12/12/2020 09:02	12/12/2020 12:33	3,50	9	31,53	CHI
20201265474	UIRAPURU	4200000405	SANTA TEREZINHA	12/12/2020 09:03	12/12/2020 09:59	12/12/2020 09:03	12/12/2020 09:59	0,92	1	0,92	CHI
20201265482	OUVIDOR	OU21134237	CATALAO S1	12/12/2020 09:05	12/12/2020 11:59	12/12/2020 09:05	12/12/2020 11:59	2,89	2	5,78	CHI
20201265484	PONTALINA	MI21030686	PONTALINA	12/12/2020 09:05	12/12/2020 17:30	12/12/2020 09:05	12/12/2020 17:30	8,40	1	8,40	CHI
20201265505	JARAGUA	JA21191290	JARAGUA	12/12/2020 09:09	12/12/2020 14:53	12/12/2020 09:09	12/12/2020 14:53	5,73	1	5,73	CHI
20201265514	AMARALINA	LC12215796	MARA ROSA	12/12/2020 09:09	14/12/2020 09:30	12/12/2020 09:09	14/12/2020 09:30	48,34	13	628,42	CHI
20201265581	INDIARA	IY12233476	EDEIA	12/12/2020 09:10	13/12/2020 14:54	12/12/2020 09:10	12/12/2020 21:32	12,37	39	482,27	CHI
20201265581	INDIARA	IY12299110LD	EDEIA	12/12/2020 09:10	13/12/2020 14:54	12/12/2020 21:33	13/12/2020 08:42	11,15	20	222,96	CHI
20201265581	INDIARA	IY12299110LD	EDEIA	12/12/2020 09:10	13/12/2020 14:54	13/12/2020 08:59	13/12/2020 10:45	1,77	20	35,32	CHI
20201265581	INDIARA	IY12299110LD	EDEIA	12/12/2020 09:10	13/12/2020 14:54	12/12/2020 21:33	13/12/2020 14:21	16,79	11	184,68	CHI
20201265581	INDIARA	IY12299110LD	EDEIA	12/12/2020 09:10	13/12/2020 14:54	13/12/2020 13:20	13/12/2020 14:21	1,01	20	20,11	CHI
20201265581	INDIARA	IY12124578	EDEIA	12/12/2020 09:10	13/12/2020 14:54	12/12/2020 21:33	13/12/2020 14:54	17,35	8	138,82	CHI
20201265520	JATAI	JT11377858	JATAI S2	12/12/2020 09:11	12/12/2020 12:52	12/12/2020 09:11	12/12/2020 12:52	3,67	1	3,67	CHI
20201265600	PIRENOPOLIS	PV12000461	SAO FRANCISCO DE GOIAS	12/12/2020 09:11	12/12/2020 22:31	12/12/2020 09:11	12/12/2020 22:31	13,32	68	905,80	CHI
20201265523	GOIAS	GS12250576	GOIAS	12/12/2020 09:12	12/12/2020 11:04	12/12/2020 09:12	12/12/2020 11:04	1,86	8	14,90	CHI
20201265553	NOVO GAMA	2900095962	PACAEMBU S2	12/12/2020 09:12	12/12/2020 12:12	12/12/2020 09:12	12/12/2020 12:12	2,99	1	2,99	CHI

20201265526	JOVIANIA	JV12071645	GOIATUBA S1	12/12/2020 09:13	12/12/2020 17:39	12/12/2020 09:13	12/12/2020 17:39	8,43	1	8,43	CHI
20201265531	ALEXANIA	AX21236666	ALEXANIA	12/12/2020 09:13	12/12/2020 13:18	12/12/2020 09:13	12/12/2020 13:18	4,07	1	4,07	CHI
20201265533	LUZIANIA	LZ12313537	CRISTALINA S2	12/12/2020 09:14	12/12/2020 12:25	12/12/2020 09:14	12/12/2020 12:25	3,18	6	19,06	CHI
20201266902	MINEIROS	MY12048095	PARQUE DAS EMAS	12/12/2020 09:14	12/12/2020 18:33	12/12/2020 09:14	12/12/2020 18:33	9,30	21	195,36	CHI
20201265540	TROMBAS	PO12354463	PORANGATU	12/12/2020 09:15	12/12/2020 22:29	12/12/2020 09:15	12/12/2020 22:29	13,22	1	13,22	CHI
20201265540	PORANGATU	PO12354463	PORANGATU	12/12/2020 09:15	12/12/2020 22:29	12/12/2020 09:15	12/12/2020 22:29	13,22	1	13,22	CHI
20201265541	SANTO ANTONIO DA BARRA	BZ21048997	ACREUNA	12/12/2020 09:15	12/12/2020 12:00	12/12/2020 09:15	12/12/2020 12:00	2,74	1	2,74	CHI
20201265712	COCALZINHO DE GOIAS	ZN12327436	GOIANESIA S1	12/12/2020 09:16	12/12/2020 23:12	12/12/2020 09:16	12/12/2020 23:12	13,92	14	194,91	CHI
20201265552	DIORAMA	DI12231285	ARENOPOLIS	12/12/2020 09:17	12/12/2020 11:53	12/12/2020 09:17	12/12/2020 11:53	2,59	1	2,59	CHI
20201265861	AGUA FRIA DE GOIAS	TL12279984	SAO JOAO D ALIANCA	12/12/2020 09:19	12/12/2020 13:16	12/12/2020 09:19	12/12/2020 13:16	3,94	5	19,71	CHI
20201265568	ANAPOLIS	AN21130772	JUNDIAI S2	12/12/2020 09:20	12/12/2020 13:18	12/12/2020 09:20	12/12/2020 13:18	3,95	64	253,03	CHI
20201265571	FLORES DE GOIAS	FB11286858	FLORES DE GOIAS	12/12/2020 09:21	12/12/2020 17:37	12/12/2020 09:21	12/12/2020 17:37	8,26	1	8,26	CHI
20201265677	PIRES DO RIO	PR12083163	PIRES DO RIO S1	12/12/2020 09:22	12/12/2020 11:39	12/12/2020 09:22	12/12/2020 11:39	2,28	5	11,40	CHI
20201265582	CRISTALINA	KR12386999	CRISTALINA S2	12/12/2020 09:23	12/12/2020 13:50	12/12/2020 09:23	12/12/2020 13:50	4,44	2	8,88	CHI
20201265590	GOIANIA	17004652	GOIANIA LESTE S2	12/12/2020 09:24	12/12/2020 11:26	12/12/2020 09:24	12/12/2020 11:26	2,02	1	2,02	CHI
20201265591	MINEIROS	DP12345408	PARQUE DAS EMAS	12/12/2020 09:25	12/12/2020 11:14	12/12/2020 09:25	12/12/2020 11:14	1,82	1	1,82	CHI
20201265591	JATAI	DP12345408	PARQUE DAS EMAS	12/12/2020 09:25	12/12/2020 11:14	12/12/2020 09:25	12/12/2020 11:14	1,82	3	5,45	CHI
20201265592	PORANGATU	PO21224148	PORANGATU	12/12/2020 09:25	12/12/2020 14:44	12/12/2020 09:25	12/12/2020 14:44	5,31	1	5,31	CHI
20201265596	HEITORAI	HE12223980	ITAPURANGA	12/12/2020 09:25	12/12/2020 11:18	12/12/2020 09:25	12/12/2020 11:18	1,87	6	11,24	CHI
20201265598	NOVO GAMA	2900100428	MARAJOARA	12/12/2020 09:25	12/12/2020 12:14	12/12/2020 09:25	12/12/2020 12:14	2,80	1	2,80	CHI
20201266304	CRISTALINA	KR12348534	PAMPLONA	12/12/2020 09:28	12/12/2020 17:02	12/12/2020 09:28	12/12/2020 17:02	7,56	5	37,79	CHI
20201268029	JARAGUA	JA12034846	JARAGUA	12/12/2020 09:28	12/12/2020 20:24	12/12/2020 09:28	12/12/2020 20:24	10,93	4	43,71	CHI
20201265610	MORRINHOS	MR21049688	MORRINHOS	12/12/2020 09:29	12/12/2020 11:59	12/12/2020 09:29	12/12/2020 11:59	2,50	1	2,50	CHI
20201265612	PORTELANDIA	PW21205295	PARQUE DAS EMAS	12/12/2020 09:30	12/12/2020 21:18	12/12/2020 09:30	12/12/2020 21:18	11,80	1	11,80	CHI
20201265614	SERRANOPOLIS	SX21209928	JATAI S1	12/12/2020 09:30	12/12/2020 17:50	12/12/2020 09:30	12/12/2020 17:50	8,32	1	8,32	CHI
20201266432	SILVANIA	SV12282710	VIANOPOLIS	12/12/2020 09:32	12/12/2020 16:50	12/12/2020 09:32	12/12/2020 16:50	7,28	4	29,14	CHI
20201265626	SAO MIGUEL DO PASSA QUATRO	SV12319545LD	BELA VISTA S2	12/12/2020 09:33	12/12/2020 12:12	12/12/2020 09:33	12/12/2020 12:12	2,64	2	5,28	CHI
20201265626	CALDAZINHA	SV12319545LD	BELA VISTA S2	12/12/2020 09:33	12/12/2020 12:12	12/12/2020 09:33	12/12/2020 12:12	2,64	6	15,83	CHI
20201265626	SILVANIA	SV12319545LD	BELA VISTA S2	12/12/2020 09:33	12/12/2020 12:12	12/12/2020 09:33	12/12/2020 12:12	2,64	77	203,11	CHI
20201265626	BELA VISTA DE GOIAS	SV12319545LD	BELA VISTA S2	12/12/2020 09:33	12/12/2020 12:12	12/12/2020 09:33	12/12/2020 12:12	2,64	75	197,83	CHI
20201265628	CAMPINACU	UC12239728	PORANGATU	12/12/2020 09:33	12/12/2020 13:07	12/12/2020 09:33	12/12/2020 13:07	3,55	9	31,97	CHI
20201266135	MONTES CLAROS DE GOIAS	DI12085423	IPORA	12/12/2020 09:33	12/12/2020 20:15	12/12/2020 09:33	12/12/2020 20:15	10,69	5	53,46	CHI
20201266135	DIORAMA	DI12085423	IPORA	12/12/2020 09:33	12/12/2020 20:15	12/12/2020 09:33	12/12/2020 20:15	10,69	1	10,69	CHI
20201265630	APARECIDA DE GOIANIA	10001366589	ANHANGUERA	12/12/2020 09:34	12/12/2020 10:50	12/12/2020 09:34	12/12/2020 10:50	1,25	1	1,25	CHI
20201265632	JATAI	290187503	JATAI S2	12/12/2020 09:35	12/12/2020 11:16	12/12/2020 09:35	12/12/2020 11:16	1,68	1	1,68	CHI
202012123783	ARENOPOLIS	AY12040870	ARENOPOLIS	12/12/2020 09:35	13/12/2020 12:13	12/12/2020 09:35	13/12/2020 12:13	26,62	24	638,96	CHI
20201265645	PORANGATU	PO21100766	PORANGATU	12/12/2020 09:36	12/12/2020 09:49	12/12/2020 09:36	12/12/2020 09:49	0,21	2	0,42	CHI
20201265642	GOIAS	GS21270989	ITABERAI S1	12/12/2020 09:37	12/12/2020 12:39	12/12/2020 09:37	12/12/2020 12:39	3,03	16	48,52	CHI
20201265650	PIRACANJUBA	PJ11171418	PIRACANJUBA	12/12/2020 09:38	13/12/2020 08:19	12/12/2020 09:38	13/12/2020 08:19	22,68	1	22,68	CHI
20201266189	SAO LUIZ DO NORTE	SZ21344746	BARRO ALTO	12/12/2020 09:38	12/12/2020 22:10	12/12/2020 09:38	12/12/2020 22:10	12,53	1	12,53	CHI
20201265654	BOM JARDIM DE GOIAS	BM12354692	BOM JARDIM	12/12/2020 09:40	12/12/2020 14:35	12/12/2020 09:40	12/12/2020 14:35	4,91	4	19,65	CHI
20201265660	PIRES DO RIO	PR12255823	PIRES DO RIO S1	12/12/2020 09:41	12/12/2020 11:02	12/12/2020 09:41	12/12/2020 11:02	1,35	8	10,77	CHI
20201265662	ITAPURANGA	IK11051552	ITAPURANGA	12/12/2020 09:41	12/12/2020 14:07	12/12/2020 09:41	12/12/2020 14:07	4,43	76	336,32	CHI
20201265668	APARECIDA DE GOIANIA	10014754086	ANHANGUERA	12/12/2020 09:42	12/12/2020 11:53	12/12/2020 09:42	12/12/2020 11:53	2,18	1	2,18	CHI
20201265701	DISTRITO FEDERAL	IO12037555	CATALAO S1	12/12/2020 09:42	12/12/2020 10:14	12/12/2020 09:42	12/12/2020 10:14	0,52	2	1,04	CHI
20201265701	DAVINOPOLIS	IO12037555	CATALAO S1	12/12/2020 09:42	12/12/2020 10:14	12/12/2020 09:42	12/12/2020 10:14	0,52	16	8,36	CHI
20201265675	ANAPOLIS	21313416	ANAPOLIS UNIVERSITARIO S2	12/12/2020 09:43	12/12/2020 21:17	12/12/2020 09:43	12/12/2020 21:17	11,56	1	11,56	CHI
20201265676	CABECEIRAS	CW21157340	ITUIQUIRA	12/12/2020 09:43	12/12/2020 21:11	12/12/2020 09:43	12/12/2020 21:11	11,45	1	11,45	CHI
20201266390	JUSSARA	JR12220050	JUSSARA	12/12/2020 09:43	12/12/2020 15:40	12/12/2020 09:43	12/12/2020 15:40	5,95	2	11,90	CHI
20201265682	ANAPOLIS	20522824	JUNDIAI S1	12/12/2020 09:45	12/12/2020 17:49	12/12/2020 09:45	12/12/2020 17:49	8,06	1	8,06	CHI
20201265731	ANAPOLIS	AN12319783	ANAPOLIS UNIVERSITARIO S2	12/12/2020 09:46	12/12/2020 11:34	12/12/2020 09:46	12/12/2020 11:34	1,79	1	1,79	CHI

20201265731	PIRENOPOLIS	AN12319783	ANAPOLIS UNIVERSITARIO S2	12/12/2020 09:46	12/12/2020 11:34	12/12/2020 09:46	12/12/2020 11:34	1,79	18	32,25	CHI
20201266085	RIO VERDE	RV12217551	JATAI S2	12/12/2020 09:47	12/12/2020 13:51	12/12/2020 09:47	12/12/2020 13:51	4,06	6	24,39	CHI
20201265694	PALESTINA DE GOIAS	PY12371033	PALESTINA	12/12/2020 09:48	12/12/2020 12:33	12/12/2020 09:48	12/12/2020 12:33	2,75	3	8,24	CHI
20201266418	PADRE BERNARDO	PB12261449	PADRE BERNARDO	12/12/2020 09:49	12/12/2020 16:54	12/12/2020 09:49	12/12/2020 16:54	7,07	1	7,07	CHI
20201265706	ALTO PARAISO DE GOIAS	BF21245425	FLORES DE GOIAS	12/12/2020 09:50	12/12/2020 11:33	12/12/2020 09:50	12/12/2020 11:33	1,71	1	1,71	CHI
20201265708	FORMOSA	610167893	ITUIQUIRA	12/12/2020 09:50	12/12/2020 10:05	12/12/2020 09:50	12/12/2020 10:05	0,24	1	0,24	CHI
20201265709	VALPARAISO DE GOIAS	10007865943	MARAJOARA	12/12/2020 09:50	12/12/2020 11:38	12/12/2020 09:50	12/12/2020 11:38	1,79	1	1,79	CHI
20201265713	SANTO ANTONIO DO DESCOBERTO	SN21086752	ALEXANIA	12/12/2020 09:51	12/12/2020 13:48	12/12/2020 09:51	12/12/2020 13:48	3,94	1	3,94	CHI
20201265716	APARECIDA DE GOIANIA	16707473	REAL S1	12/12/2020 09:52	12/12/2020 11:03	12/12/2020 09:52	12/12/2020 11:03	1,17	1	1,17	CHI
20201265717	PARANAIGUARA	PC21261008	CACHOEIRA ALTA	12/12/2020 09:53	12/12/2020 14:56	12/12/2020 09:53	12/12/2020 14:56	5,05	1	5,05	CHI
20201265719	TRINDADE	10030791365	GOIANIRA	12/12/2020 09:53	12/12/2020 12:22	12/12/2020 09:53	12/12/2020 12:22	2,47	1	2,47	CHI
20201265720	CABECEIRAS	CW12154421	ITUIQUIRA	12/12/2020 09:53	12/12/2020 14:30	12/12/2020 09:53	12/12/2020 14:30	4,60	4	18,42	CHI
20201265725	CAMPINORTE	CR11253128	PORANGATU	12/12/2020 09:54	13/12/2020 02:46	12/12/2020 09:54	13/12/2020 02:46	16,85	1	16,85	CHI
20201265726	FORMOSO	FO12170963	MARA ROSA	12/12/2020 09:55	13/12/2020 12:15	12/12/2020 09:55	13/12/2020 11:21	25,44	4	101,76	CHI
20201265726	FORMOSO	FO12170963	MARA ROSA	12/12/2020 09:55	13/12/2020 12:15	12/12/2020 09:55	13/12/2020 12:15	26,33	7	184,34	CHI
20201265727	GOIANIA	10001519687	INDEPENDENCIA S1	12/12/2020 09:56	12/12/2020 11:21	12/12/2020 09:56	12/12/2020 11:21	1,41	1	1,41	CHI
20201265728	PALMEIRAS DE GOIAS	PL21000058	PALMEIRAS	12/12/2020 09:56	12/12/2020 13:00	12/12/2020 09:56	12/12/2020 13:00	3,06	1	3,06	CHI
20201265730	ALEXANIA	480044132	ALEXANIA	12/12/2020 09:56	12/12/2020 13:05	12/12/2020 09:56	12/12/2020 13:05	3,14	1	3,14	CHI
20201265732	SAO MIGUEL DO ARAGUAIA	SM12262773	SAO MIGUEL DO ARAGUAIA	12/12/2020 09:58	13/12/2020 14:11	12/12/2020 09:58	13/12/2020 14:11	28,21	2	56,43	CHI
20201265733	HIDROLANDIA	HD12045729LD	INDEPENDENCIA S1	12/12/2020 09:58	12/12/2020 11:54	12/12/2020 09:58	12/12/2020 11:54	1,93	21	40,50	CHI
20201265741	EDEALINA	ED12039150	PONTALINA	12/12/2020 09:58	12/12/2020 12:31	12/12/2020 09:58	12/12/2020 12:31	2,54	3	7,62	CHI
20201265741	EDEIA	ED12039150	PONTALINA	12/12/2020 09:58	12/12/2020 12:31	12/12/2020 09:58	12/12/2020 12:31	2,54	8	20,33	CHI
20201266064	JUSSARA	RN12250752	BRITANIA	12/12/2020 09:58	12/12/2020 14:26	12/12/2020 09:58	12/12/2020 14:26	4,45	19	84,62	CHI
20201266064	SANTA FE DE GOIAS	RN12250752	BRITANIA	12/12/2020 09:58	12/12/2020 14:26	12/12/2020 09:58	12/12/2020 14:26	4,45	37	164,79	CHI
20201265744	RIO QUENTE	RQ21196407	VILA CORUMBA	12/12/2020 09:59	12/12/2020 16:03	12/12/2020 09:59	12/12/2020 16:03	6,05	1	6,05	CHI
20201265746	NOVO GAMA	10004978372	PACAEMBU S2	12/12/2020 09:59	12/12/2020 11:15	12/12/2020 09:59	12/12/2020 11:15	1,25	1	1,25	CHI
20201265756	RIO VERDE	630220440	RIO VERDE S1	12/12/2020 10:00	12/12/2020 17:32	12/12/2020 10:00	12/12/2020 17:32	7,54	1	7,54	CHI
20201265761	TRINDADE	TR21169181	TRINDADE	12/12/2020 10:01	12/12/2020 12:21	12/12/2020 10:01	12/12/2020 12:21	2,32	1	2,32	CHI
20201266136	CRISTALINA	KR12096911	PAMPLONA	12/12/2020 10:01	12/12/2020 13:40	12/12/2020 10:01	12/12/2020 13:40	3,64	13	47,38	CHI
20201265767	GOIANIA	10013857434	MEIA PONTE	12/12/2020 10:03	12/12/2020 16:01	12/12/2020 10:03	12/12/2020 16:01	5,96	1	5,96	CHI
20201265771	MONTIVIDIU	CP12267739	MONTIVIDIU T	12/12/2020 10:04	12/12/2020 15:14	12/12/2020 10:04	12/12/2020 15:14	5,16	3	15,48	CHI
20201265771	CAIAPONIA	CP12267739	MONTIVIDIU T	12/12/2020 10:04	12/12/2020 15:14	12/12/2020 10:04	12/12/2020 15:14	5,16	2	10,32	CHI
20201265775	ITAPIRAPUA	IU21072482	MATRINCHA	12/12/2020 10:04	12/12/2020 16:55	12/12/2020 10:04	12/12/2020 16:55	6,86	2	13,71	CHI
20201265779	SAO MIGUEL DO ARAGUAIA	SM12143671	SAO MIGUEL DO ARAGUAIA	12/12/2020 10:05	12/12/2020 11:48	12/12/2020 10:05	12/12/2020 11:48	1,70	276	470,20	CHI
20201265782	FORMOSA	FA12106823	ITUIQUIRA	12/12/2020 10:07	12/12/2020 15:40	12/12/2020 10:07	12/12/2020 15:40	5,55	2	11,09	CHI
20201265790	APARECIDA DE GOIANIA	14159582	INDEPENDENCIA S2	12/12/2020 10:08	12/12/2020 11:55	12/12/2020 10:08	12/12/2020 11:55	1,77	1	1,77	CHI
20201265892	PIRACANJUBA	BV12410344	BELA VISTA S1	12/12/2020 10:08	12/12/2020 12:38	12/12/2020 10:08	12/12/2020 12:38	2,48	89	221,09	CHI
20201265892	BELA VISTA DE GOIAS	BV12410344	BELA VISTA S1	12/12/2020 10:08	12/12/2020 12:38	12/12/2020 10:08	12/12/2020 12:38	2,48	40	99,37	CHI
20201265794	APARECIDA DE GOIANIA	14619490	ATLANTICO S2	12/12/2020 10:09	12/12/2020 15:20	12/12/2020 10:09	12/12/2020 15:20	5,18	1	5,18	CHI
20201265801	TRINDADE	10029852976	TRINDADE	12/12/2020 10:11	12/12/2020 11:50	12/12/2020 10:11	12/12/2020 11:50	1,65	1	1,65	CHI
20201265802	FORMOSA	FA21257706	ITUIQUIRA	12/12/2020 10:11	12/12/2020 10:52	12/12/2020 10:11	12/12/2020 10:52	0,68	1	0,68	CHI
20201265803	LUZIANIA	120031346	RIO VERMELHO	12/12/2020 10:11	12/12/2020 12:23	12/12/2020 10:11	12/12/2020 12:23	2,19	1	2,19	CHI
20201265815	SANTA HELENA DE GOIAS	SH21010227	IPEGUARI	12/12/2020 10:12	12/12/2020 13:01	12/12/2020 10:12	12/12/2020 13:01	2,80	1	2,80	CHI
20201265818	LUZIANIA	120392239	MARAJOARA	12/12/2020 10:13	12/12/2020 11:31	12/12/2020 10:13	12/12/2020 11:31	1,30	1	1,30	CHI
20201265863	SILVANIA	SV12011158	DAIA S2	12/12/2020 10:13	12/12/2020 14:09	12/12/2020 10:13	12/12/2020 14:09	3,92	17	66,65	CHI
20201266159	AGUAS LINDAS DE GOIAS	20637719	AGUAS LINDAS DE GOIAS S1	12/12/2020 10:14	12/12/2020 13:10	12/12/2020 10:14	12/12/2020 13:10	2,92	4	11,70	CHI
20201265831	JATAI	JT12337022	JATAI S2	12/12/2020 10:15	12/12/2020 13:40	12/12/2020 10:15	12/12/2020 13:40	3,41	94	320,62	CHI
20201265894	GOIANIA	GN11340277	CARAJAS S1	12/12/2020 10:15	12/12/2020 13:21	12/12/2020 10:15	12/12/2020 13:21	3,09	334	1030,95	CHI
20201266936	MORRO AGUDO DE GOIAS	MS12185132LD	ITAPURANGA	12/12/2020 10:16	13/12/2020 00:59	12/12/2020 10:16	13/12/2020 00:59	14,71	4	58,85	CHI
20201266384	CRIXAS	CX12235697	SERRA DO OURO	12/12/2020 10:18	12/12/2020 21:40	12/12/2020 10:18	12/12/2020 21:40	11,37	49	556,97	CHI
20201265854	NOVO GAMA	LZ12040416	PACAEMBU S2	12/12/2020 10:19	12/12/2020 13:27	12/12/2020 10:19	12/12/2020 13:27	3,12	18	56,13	CHI

20201265859	MINACU	IH21192279	MINACU	12/12/2020 10:20	13/12/2020 03:49	12/12/2020 10:20	13/12/2020 03:49	17,48	2	34,95	CHI
20201265862	PORANGATU	PO12292385	PORANGATU	12/12/2020 10:21	12/12/2020 14:55	12/12/2020 10:21	12/12/2020 14:55	4,57	1	4,57	CHI
20201265872	NOVA CRIXAS	NA12057389	NOVA CRIXAS	12/12/2020 10:23	12/12/2020 13:55	12/12/2020 10:23	12/12/2020 13:55	3,52	4	14,09	CHI
20201265875	PIRACANJUBA	10024531500	ROCHEDO	12/12/2020 10:24	12/12/2020 20:27	12/12/2020 10:24	12/12/2020 20:27	10,04	1	10,04	CHI
20201265880	JUSSARA	JR12019908	JUSSARA	12/12/2020 10:25	12/12/2020 13:38	12/12/2020 10:25	12/12/2020 13:38	3,21	4	12,85	CHI
20201265884	TRINDADE	40163118	GOYA S1	12/12/2020 10:26	12/12/2020 13:27	12/12/2020 10:26	12/12/2020 13:27	3,01	1	3,01	CHI
20201265887	TRINDADE	40093207	TRINDADE	12/12/2020 10:27	12/12/2020 13:03	12/12/2020 10:27	12/12/2020 13:03	2,58	1	2,58	CHI
20201265888	GOIANDIRA	2010020401	CATALAO S1	12/12/2020 10:28	12/12/2020 20:04	12/12/2020 10:28	12/12/2020 20:04	9,60	1	9,60	CHI
20201265896	CRISTALINA	KR21237897	CRISTALINA S2	12/12/2020 10:29	12/12/2020 13:01	12/12/2020 10:29	12/12/2020 13:01	2,52	1	2,52	CHI
20201265901	PORTELANDIA	PW21237026	PARQUE DAS EMAS	12/12/2020 10:30	12/12/2020 19:27	12/12/2020 10:30	12/12/2020 19:27	8,94	1	8,94	CHI
20201265903	LUZIANIA	LZ21304845	MARAJOARA	12/12/2020 10:31	12/12/2020 19:47	12/12/2020 10:31	12/12/2020 19:47	9,26	2	18,53	CHI
20201265911	GOIANIA	15958619	CARAJAS S1	12/12/2020 10:33	12/12/2020 14:02	12/12/2020 10:33	12/12/2020 14:02	3,48	1	3,48	CHI
20201265914	CAMPO LIMPO	AN21258866	NEROPOLIS S1	12/12/2020 10:33	12/12/2020 13:46	12/12/2020 10:33	12/12/2020 13:46	3,20	1	3,20	CHI
20201265916	PIRENOPOLIS	PV21298821	GOIANESIA S1	12/12/2020 10:34	12/12/2020 17:08	12/12/2020 10:34	12/12/2020 17:08	6,56	1	6,56	CHI
20201265918	JATAI	JT11164258	JATAI S2	12/12/2020 10:34	12/12/2020 12:40	12/12/2020 10:34	12/12/2020 12:40	2,09	31	64,94	CHI
20201265926	ANAPOLIS	21027110	ANAPOLIS UNIVERSITARIO S2	12/12/2020 10:36	12/12/2020 12:35	12/12/2020 10:36	12/12/2020 12:35	1,97	1	1,97	CHI
20201265931	CACHOEIRA ALTA	CA12013330RE	CACHOEIRA ALTA	12/12/2020 10:38	12/12/2020 13:34	12/12/2020 10:38	12/12/2020 13:34	2,93	22	64,50	CHI
20201265935	JATAI	JT12274139	JATAI S1	12/12/2020 10:39	12/12/2020 19:03	12/12/2020 10:39	12/12/2020 19:03	8,40	1	8,40	CHI
20201265939	JATAI	JT11379633	JATAI S2	12/12/2020 10:39	12/12/2020 12:11	12/12/2020 10:39	12/12/2020 12:11	1,52	5	7,62	CHI
20201265942	COLINAS DO SUL	TI12155523RE	MINACU	12/12/2020 10:40	13/12/2020 04:13	12/12/2020 10:40	13/12/2020 04:13	17,54	18	315,64	CHI
20201265943	APARECIDA DE GOIANIA	10005147156	REAL S2	12/12/2020 10:40	12/12/2020 11:34	12/12/2020 10:40	12/12/2020 11:34	0,88	1	0,88	CHI
20201266058	MARA ROSA	MQ12266532	MARA ROSA	12/12/2020 10:42	13/12/2020 12:08	12/12/2020 10:42	13/12/2020 12:08	25,43	3	76,29	CHI
20201265947	MIMOSO DE GOIAS	MJ12382937	PADRE BERNARDO	12/12/2020 10:43	12/12/2020 14:12	12/12/2020 10:43	12/12/2020 14:12	3,48	3	10,44	CHI
20201265948	VARJAO	VJ31099610	GUAPO S2	12/12/2020 10:43	12/12/2020 16:24	12/12/2020 10:43	12/12/2020 16:24	5,68	2	11,36	CHI
20201265949	CATALAO	CT21428082	CATALAO S1	12/12/2020 10:43	12/12/2020 11:56	12/12/2020 10:43	12/12/2020 11:56	1,21	1	1,21	CHI
20201266627	JATAI	JT11337011	JATAI S2	12/12/2020 10:43	12/12/2020 14:12	12/12/2020 10:43	12/12/2020 14:12	3,47	130	451,28	CHI
20201265952	SAO JOAO DA PARAUNA	PU12004108	FIRMINOPOLIS S2	12/12/2020 10:44	12/12/2020 15:52	12/12/2020 10:44	12/12/2020 15:52	5,12	2	10,24	CHI
20201265952	PARAUNA	PU12004108	FIRMINOPOLIS S2	12/12/2020 10:44	12/12/2020 15:52	12/12/2020 10:44	12/12/2020 15:52	5,12	3	15,36	CHI
20201265953	ITUMBIARA	690115787	ITUMBIARA NOVA	12/12/2020 10:45	13/12/2020 16:42	12/12/2020 10:45	13/12/2020 16:42	29,94	1	29,94	CHI
20201265955	AGUAS LINDAS DE GOIAS	4830106683	AGUAS LINDAS DE GOIAS S1	12/12/2020 10:45	12/12/2020 12:04	12/12/2020 10:45	12/12/2020 12:04	1,30	1	1,30	CHI
20201265957	RIO VERDE	RV13240308	MONTIVIDIU T	12/12/2020 10:46	12/12/2020 22:08	12/12/2020 10:46	12/12/2020 22:08	11,37	9	102,35	CHI
20201265957	RIO VERDE	RV13240308	MONTIVIDIU T	12/12/2020 10:46	12/12/2020 22:08	12/12/2020 18:28	12/12/2020 22:08	3,66	41	150,14	CHI
20201265963	MINEIROS	MY21205291	PARQUE DAS EMAS	12/12/2020 10:48	12/12/2020 21:16	12/12/2020 10:48	12/12/2020 21:16	10,47	1	10,47	CHI
20201265965	PALMELO	PR12000096RE	PIRES DO RIO S1	12/12/2020 10:48	12/12/2020 12:25	12/12/2020 10:48	12/12/2020 12:25	1,61	6	9,65	CHI
20201265965	PIRES DO RIO	PR12000096RE	PIRES DO RIO S1	12/12/2020 10:48	12/12/2020 12:25	12/12/2020 10:48	12/12/2020 12:25	1,61	22	35,38	CHI
20201265971	PADRE BERNARDO	PB21163190	PADRE BERNARDO	12/12/2020 10:50	12/12/2020 12:32	12/12/2020 10:50	12/12/2020 12:32	1,69	1	1,69	CHI
20201265975	CAMPOS BELOS	CH21257289	SAO DOMINGOS	12/12/2020 10:52	12/12/2020 11:30	12/12/2020 10:52	12/12/2020 11:30	0,63	1	0,63	CHI
20201266017	SAO JOAO D ALIANCA	JL12261887	SAO JOAO D ALIANCA	12/12/2020 10:52	12/12/2020 12:22	12/12/2020 10:52	12/12/2020 12:22	1,49	5	7,43	CHI
20201266017	AGUA FRIA DE GOIAS	JL12261887	SAO JOAO D ALIANCA	12/12/2020 10:52	12/12/2020 12:22	12/12/2020 10:52	12/12/2020 12:22	1,49	1	1,49	CHI
20201265984	RIO VERDE	630555801	RIO VERDE S2	12/12/2020 10:54	12/12/2020 14:37	12/12/2020 10:54	12/12/2020 14:37	3,72	1	3,72	CHI
20201265988	COCALZINHO DE GOIAS	ZN21067368	AGUAS LINDAS DE GOIAS S1	12/12/2020 10:54	12/12/2020 15:25	12/12/2020 10:54	12/12/2020 15:25	4,51	1	4,51	CHI
20201265992	BELA VISTA DE GOIAS	BV21184796	BELA VISTA S1	12/12/2020 10:56	12/12/2020 13:01	12/12/2020 10:56	12/12/2020 13:01	2,08	3	6,24	CHI
20201265995	CIDADE OCIDENTAL	19782163	MARAJOARA	12/12/2020 10:57	12/12/2020 14:14	12/12/2020 10:57	12/12/2020 14:14	3,28	5	16,41	CHI
20201265996	ARUANA	AK12016451	BRITANIA	12/12/2020 10:57	12/12/2020 13:55	12/12/2020 10:57	12/12/2020 13:55	2,96	2	5,92	CHI
20201265998	JATAI	JT12264438	JATAI S1	12/12/2020 10:57	12/12/2020 14:23	12/12/2020 10:57	12/12/2020 14:23	3,43	2	6,85	CHI
20201266000	APARECIDA DE GOIANIA	11685621	INDEPENDENCIA S2	12/12/2020 10:57	12/12/2020 12:23	12/12/2020 10:57	12/12/2020 12:23	1,42	1	1,42	CHI
20201266002	CRISTALINA	KR21163628	PAMPLONA	12/12/2020 10:57	12/12/2020 20:04	12/12/2020 10:57	12/12/2020 20:04	9,10	1	9,10	CHI
20201266951	MINACU	IH12360453	MINACU	12/12/2020 10:57	12/12/2020 18:58	12/12/2020 10:57	12/12/2020 18:58	8,01	72	576,66	CHI
20201266951	CAMPINACU	IH12360453	MINACU	12/12/2020 10:57	12/12/2020 18:58	12/12/2020 10:57	12/12/2020 18:58	8,01	5	40,05	CHI
20201266008	QUIRINOPOLIS	80120738	QUIRINOPOLIS	12/12/2020 10:59	12/12/2020 14:31	12/12/2020 10:59	12/12/2020 14:31	3,52	1	3,52	CHI
20201266013	GOIANIA	15875854	GOIANIA LESTE S1	12/12/2020 11:01	12/12/2020 13:22	12/12/2020 11:01	12/12/2020 13:22	2,34	1	2,34	CHI

20201266212	TRINDADE	TR11321106	TRINDADE	12/12/2020 11:01	12/12/2020 12:54	12/12/2020 11:01	12/12/2020 12:54	1,87	81	151,74	CHI
20201266018	JATAI	JT21234197	JATAI S1	12/12/2020 11:02	12/12/2020 14:47	12/12/2020 11:02	12/12/2020 14:47	3,75	1	3,75	CHI
20201266026	CIDADE OCIDENTAL	2680024959	MARAJÓARA	12/12/2020 11:03	12/12/2020 12:23	12/12/2020 11:03	12/12/2020 12:23	1,32	1	1,32	CHI
20201266456	JUSSARA	JR12055958	JUSSARA	12/12/2020 11:03	12/12/2020 18:27	12/12/2020 11:03	12/12/2020 18:27	7,39	8	59,15	CHI
20201266032	GOIANIA	16146141	CAMPINAS S2	12/12/2020 11:05	12/12/2020 12:16	12/12/2020 11:05	12/12/2020 12:16	1,18	1	1,18	CHI
20201266037	IPORA	IR21087171	IPORA	12/12/2020 11:05	12/12/2020 12:39	12/12/2020 11:05	12/12/2020 12:39	1,56	1	1,56	CHI
20201266039	GAMELEIRA DE GOIAS	SV21040503	DAIA S2	12/12/2020 11:06	12/12/2020 19:11	12/12/2020 11:06	12/12/2020 19:11	8,07	1	8,07	CHI
20201266375	SANTA TEREZA DE GOIAS	TB12262770	PORANGATU	12/12/2020 11:06	12/12/2020 21:13	12/12/2020 11:06	12/12/2020 21:13	10,10	5	50,51	CHI
20201266375	TROMBAS	TB12262770	PORANGATU	12/12/2020 11:06	12/12/2020 21:13	12/12/2020 11:06	12/12/2020 21:13	10,10	13	131,33	CHI
20201266375	PORANGATU	TB12262770	PORANGATU	12/12/2020 11:06	12/12/2020 21:13	12/12/2020 11:06	12/12/2020 21:13	10,10	1	10,10	CHI
20201266042	ITAPIRAPUA	IU12018776	JUSSARA	12/12/2020 11:07	13/12/2020 08:16	12/12/2020 11:07	13/12/2020 08:16	21,13	3	63,40	CHI
20201266043	ANICUNS	AC21030997	ANICUNS	12/12/2020 11:07	12/12/2020 14:40	12/12/2020 11:07	12/12/2020 14:40	3,53	2	7,07	CHI
20201266055	FAINA	MP21240010	MATRINCHA	12/12/2020 11:09	13/12/2020 07:57	12/12/2020 11:09	13/12/2020 07:57	20,79	1	20,79	CHI
20201266056	SANCLERLANDIA	SC21019508	FIRMINOPOLIS S2	12/12/2020 11:09	12/12/2020 13:47	12/12/2020 11:09	12/12/2020 13:47	2,62	2	5,25	CHI
20201266059	CIDADE OCIDENTAL	10027652716	MARAJÓARA	12/12/2020 11:09	12/12/2020 15:37	12/12/2020 11:09	12/12/2020 15:37	4,45	1	4,45	CHI
20201266063	QUIRINOPOLIS	80014173	QUIRINOPOLIS	12/12/2020 11:10	12/12/2020 13:57	12/12/2020 11:10	12/12/2020 13:57	2,79	1	2,79	CHI
20201266067	PIRENOPOLIS	PV12337697	CORUMBA	12/12/2020 11:12	12/12/2020 19:26	12/12/2020 11:12	12/12/2020 19:26	8,23	5	41,16	CHI
20201266070	JUSSARA	JR21158988	BRITANIA	12/12/2020 11:13	13/12/2020 10:06	12/12/2020 11:13	13/12/2020 10:06	22,88	1	22,88	CHI
20201266078	JATAI	JT12231036	JATAI S2	12/12/2020 11:14	12/12/2020 13:21	12/12/2020 11:14	12/12/2020 13:21	2,11	2	4,22	CHI
20201266082	MORRINHOS	MR21265902	MORRINHOS	12/12/2020 11:15	12/12/2020 13:56	12/12/2020 11:15	12/12/2020 13:56	2,67	1	2,67	CHI
20201266086	IPORA	IR12201969LD	IPORA	12/12/2020 11:15	12/12/2020 14:52	12/12/2020 14:26	12/12/2020 14:52	0,43	107	46,37	CHI
20201266084	COLINAS DO SUL	TI21289884	MINACU	12/12/2020 11:16	13/12/2020 07:55	12/12/2020 11:16	13/12/2020 07:55	20,65	2	41,30	CHI
20201266089	VIANOPOLIS	510004064	VIANOPOLIS	12/12/2020 11:18	12/12/2020 12:48	12/12/2020 11:18	12/12/2020 12:48	1,50	1	1,50	CHI
20201266094	FLORES DE GOIAS	FB21242936	FLORES DE GOIAS	12/12/2020 11:19	13/12/2020 07:10	12/12/2020 11:19	13/12/2020 07:10	19,84	1	19,84	CHI
20201266099	PARANAIGUARA	CA12081277	CACHOEIRA ALTA	12/12/2020 11:21	12/12/2020 15:50	12/12/2020 11:21	12/12/2020 15:50	4,48	2	8,95	CHI
20201266101	ARAGARCAS	1820036628	ARAGARCAS	12/12/2020 11:21	12/12/2020 21:05	12/12/2020 11:21	12/12/2020 21:05	9,72	1	9,72	CHI
20201266112	LUZIANIA	LZ21192756	VIANOPOLIS	12/12/2020 11:24	12/12/2020 12:02	12/12/2020 11:24	12/12/2020 12:02	0,62	1	0,62	CHI
20201266116	PORANGATU	PO12371057LD	PORANGATU	12/12/2020 11:26	13/12/2020 01:33	12/12/2020 11:26	13/12/2020 01:33	14,13	229	3234,69	CHI
20201266116	PORANGATU	PO12371057LD	PORANGATU	12/12/2020 11:26	13/12/2020 01:33	12/12/2020 14:30	13/12/2020 01:33	11,05	595	6575,08	CHI
20201266117	LUZIANIA	LZ21347995	MARAJÓARA	12/12/2020 11:26	12/12/2020 17:20	12/12/2020 11:26	12/12/2020 17:20	5,89	2	11,78	CHI
20201266120	TURVELANDIA	TD21384563	RIO DOS BOIS	12/12/2020 11:26	12/12/2020 18:59	12/12/2020 11:26	12/12/2020 18:59	7,53	1	7,53	CHI
20201269317	MINACU	IH12348089	MINACU	12/12/2020 11:26	13/12/2020 01:31	12/12/2020 11:26	13/12/2020 01:31	14,08	12	168,99	CHI
20201266637	NIQUELANDIA	NQ12400337	URUACU	12/12/2020 11:27	12/12/2020 18:53	12/12/2020 11:27	12/12/2020 18:53	7,42	15	111,25	CHI
20201266131	PLANALTINA	PI21088240	PLANALTINA	12/12/2020 11:28	12/12/2020 14:04	12/12/2020 11:28	12/12/2020 14:04	2,59	1	2,59	CHI
20201266134	JANDAIA	JD12134335	PALMEIRAS	12/12/2020 11:28	13/12/2020 10:44	12/12/2020 11:28	13/12/2020 10:44	23,25	4	93,00	CHI
20201266138	NOVO BRASIL	NB21020202	JUSSARA	12/12/2020 11:30	12/12/2020 13:31	12/12/2020 11:30	12/12/2020 13:31	2,01	1	2,01	CHI
20201266139	BOM JESUS DE GOIAS	BJ21263551	BOM JESUS DE GOIAS	12/12/2020 11:30	13/12/2020 13:04	12/12/2020 11:30	13/12/2020 13:04	25,56	1	25,56	CHI
20201266140	NOVO GAMA	10010076652	MARAJÓARA	12/12/2020 11:30	12/12/2020 12:52	12/12/2020 11:30	12/12/2020 12:52	1,35	1	1,35	CHI
20201266144	IACIARA	IA21218718	IACIARA S2	12/12/2020 11:32	12/12/2020 17:44	12/12/2020 11:32	12/12/2020 17:44	6,19	1	6,19	CHI
20201266146	FORMOSA	610147640	ITUIQUIRA	12/12/2020 11:32	12/12/2020 14:11	12/12/2020 11:32	12/12/2020 14:11	2,65	1	2,65	CHI
20201266147	MONTIVIDIU	MV21104893	MONTIVIDIU T	12/12/2020 11:32	12/12/2020 16:47	12/12/2020 11:32	12/12/2020 16:47	5,23	1	5,23	CHI
20201266790	DAVINOPOLIS	IO12037555	CATALAO S1	12/12/2020 11:32	12/12/2020 18:21	12/12/2020 11:32	12/12/2020 18:21	6,81	17	115,80	CHI
20201266790	DISTRITO FEDERAL	IO12037555	CATALAO S1	12/12/2020 11:32	12/12/2020 18:21	12/12/2020 11:32	12/12/2020 18:21	6,81	2	13,62	CHI
20201266160	NOVO BRASIL	NB21064410	MATRINCHA	12/12/2020 11:36	12/12/2020 14:53	12/12/2020 11:36	12/12/2020 14:53	3,28	1	3,28	CHI
20201266161	POSSE	1480007551	IACIARA S2	12/12/2020 11:36	12/12/2020 13:05	12/12/2020 11:36	12/12/2020 13:05	1,47	1	1,47	CHI
20201266162	ALTO PARAISO DE GOIAS	BF21312327	FLORES DE GOIAS	12/12/2020 11:37	12/12/2020 15:03	12/12/2020 11:37	12/12/2020 15:03	3,43	1	3,43	CHI
20201266163	PLANALTINA	2960053996	PLANALTINA	12/12/2020 11:37	12/12/2020 13:38	12/12/2020 11:37	12/12/2020 13:38	2,01	1	2,01	CHI
20201266164	CRISTALINA	KR12245975	CRISTALINA S1	12/12/2020 11:37	12/12/2020 15:14	12/12/2020 11:37	12/12/2020 15:14	3,61	5	18,03	CHI
20201266166	LUZIANIA	LZ12059632	RIO VERMELHO	12/12/2020 11:38	12/12/2020 14:11	12/12/2020 11:38	12/12/2020 14:11	2,55	5	12,74	CHI
20201266177	GOIANIA	16892616	GOYA S2	12/12/2020 11:42	12/12/2020 16:52	12/12/2020 11:42	12/12/2020 16:52	5,17	1	5,17	CHI
20201266181	CATURAI	CK11148603	GOIANIRA	12/12/2020 11:43	12/12/2020 14:57	12/12/2020 11:43	12/12/2020 14:57	3,22	87	280,53	CHI

20201266184	ITAPIRAPUA	IU21198555	MATRINCHA	12/12/2020 11:44	12/12/2020 18:00	12/12/2020 11:44	12/12/2020 18:00	6,26	1	6,26	CHI
20201269535	SAO LUIZ DO NORTE	550111189	BARRO ALTO	12/12/2020 11:45	13/12/2020 19:04	12/12/2020 11:45	13/12/2020 19:04	31,31	1	31,31	CHI
20201266356	JATAI	JT12182167	JATAI S1	12/12/2020 11:46	12/12/2020 13:43	12/12/2020 11:46	12/12/2020 13:43	1,95	4	7,80	CHI
20201266193	MINEIROS	MY21238505	PARQUE DAS EMAS	12/12/2020 11:47	13/12/2020 01:03	12/12/2020 11:47	13/12/2020 01:03	13,25	1	13,25	CHI
20201266195	TRINDADE	10032565397	GOYA S1	12/12/2020 11:48	12/12/2020 15:50	12/12/2020 11:48	12/12/2020 15:50	4,03	1	4,03	CHI
20201266197	VALPARAISO DE GOIAS	VA11136668	PACAEMBU S1	12/12/2020 11:49	12/12/2020 13:45	12/12/2020 11:49	12/12/2020 13:45	1,93	133	256,91	CHI
20201266198	APARECIDA DE GOIANIA	10003459207	ANHANGUERA	12/12/2020 11:49	12/12/2020 13:30	12/12/2020 11:49	12/12/2020 13:30	1,68	1	1,68	CHI
20201266337	CORUMBA DE GOIAS	CB12215044	CORUMBA	12/12/2020 11:50	12/12/2020 14:10	12/12/2020 11:50	12/12/2020 14:10	2,33	23	53,60	CHI
20201266337	PIRENOPOLIS	CB12215044	CORUMBA	12/12/2020 11:50	12/12/2020 14:10	12/12/2020 11:50	12/12/2020 14:10	2,33	2	4,66	CHI
20201267104	PORANGATU	PO12241996	PORANGATU	12/12/2020 11:50	12/12/2020 17:08	12/12/2020 11:50	12/12/2020 17:08	5,29	82	434,03	CHI
20201266207	SAO LUIS DE MONTES BELOS	SL31111640	FIRMINOPOLIS S1	12/12/2020 11:51	12/12/2020 17:20	12/12/2020 11:51	12/12/2020 17:20	5,48	2	10,96	CHI
20201266208	GOIANIRA	GR31138913	MEIA PONTE	12/12/2020 11:51	12/12/2020 17:17	12/12/2020 11:51	12/12/2020 17:17	5,43	1	5,43	CHI
20201266219	PALESTINA DE GOIAS	PY12396118	PALESTINA	12/12/2020 11:53	12/12/2020 13:35	12/12/2020 11:53	12/12/2020 13:35	1,69	5	8,43	CHI
20201266223	TRINDADE	16751395	GOYA S2	12/12/2020 11:54	12/12/2020 14:14	12/12/2020 11:54	12/12/2020 14:14	2,32	1	2,32	CHI
20201266600	JARAGUA	JA12273002	JARAGUA	12/12/2020 11:54	14/12/2020 02:06	12/12/2020 11:54	13/12/2020 22:01	34,11	7	238,80	CHI
20201266600	JARAGUA	JA12273002	JARAGUA	12/12/2020 11:54	14/12/2020 02:06	12/12/2020 11:54	14/12/2020 02:06	38,20	18	687,68	CHI
20201266600	JARAGUA	JA12273002	JARAGUA	12/12/2020 11:54	14/12/2020 02:06	14/12/2020 01:18	14/12/2020 02:06	0,80	7	5,57	CHI
20201266227	CIDADE OCIDENTAL	LZ21082933	MARAJOARA	12/12/2020 11:55	12/12/2020 13:17	12/12/2020 11:55	12/12/2020 13:17	1,36	2	2,73	CHI
20201266232	PIRENOPOLIS	PV21241512	CORUMBA	12/12/2020 11:55	12/12/2020 14:15	12/12/2020 11:55	12/12/2020 14:15	2,32	1	2,32	CHI
20201266234	CIDADE OCIDENTAL	DH12415607LD	MARAJOARA	12/12/2020 11:56	12/12/2020 17:28	12/12/2020 11:56	12/12/2020 17:28	5,53	1	5,53	CHI
20201266235	RIO VERDE	10005310243	RIO VERDE S2	12/12/2020 11:56	12/12/2020 18:38	12/12/2020 11:56	12/12/2020 18:38	6,70	1	6,70	CHI
20201267062	CALDAS NOVAS	CN12000046	CALDAS NOVAS S2	12/12/2020 11:58	13/12/2020 10:23	12/12/2020 11:58	13/12/2020 10:23	22,41	13	291,28	CHI
20201266250	AGUAS LINDAS DE GOIAS	10004210970	AGUAS LINDAS DE GOIAS S1	12/12/2020 11:59	12/12/2020 14:53	12/12/2020 11:59	12/12/2020 14:53	2,89	1	2,89	CHI
20201266251	LEOPOLDO DE BULHOES	LB11067572	DAIA S2	12/12/2020 11:59	12/12/2020 14:35	12/12/2020 11:59	12/12/2020 14:35	2,59	12	31,11	CHI
20201266253	FORMOSA	FA11397731	ITUIQUIRA	12/12/2020 11:59	12/12/2020 23:19	12/12/2020 11:59	12/12/2020 23:19	11,32	1	11,32	CHI
20201266445	INDIARA	IY12194009	PALMEIRAS	12/12/2020 11:59	12/12/2020 18:46	12/12/2020 11:59	12/12/2020 18:46	6,78	20	135,69	CHI
20201266578	NOVA CRIXAS	NA12038843	NOVA CRIXAS	12/12/2020 12:00	13/12/2020 17:15	12/12/2020 12:00	13/12/2020 17:15	29,25	3	87,74	CHI
20201266259	LEOPOLDO DE BULHOES	LB21311938	DAIA S2	12/12/2020 12:01	12/12/2020 15:50	12/12/2020 12:01	12/12/2020 15:50	3,82	2	7,63	CHI
20201266267	DISTRITO FEDERAL	05410216	MARAJOARA	12/12/2020 12:02	12/12/2020 19:10	12/12/2020 12:02	12/12/2020 19:10	7,13	3	21,39	CHI
20201266267	SANTO ANTONIO DO DESCOBERTO	05410216	MARAJOARA	12/12/2020 12:02	12/12/2020 19:10	12/12/2020 12:02	12/12/2020 19:10	7,13	466	3322,32	CHI
20201266336	ABADIANIA	AA12385098	ANAPOLIS UNIVERSITARIO S1	12/12/2020 12:02	12/12/2020 18:38	12/12/2020 12:02	12/12/2020 18:38	6,59	6	39,52	CHI
20201266275	PONTALINA	10021488396	PONTALINA	12/12/2020 12:03	12/12/2020 16:21	12/12/2020 12:03	12/12/2020 16:21	4,29	1	4,29	CHI
20201266277	SANTO ANTONIO DA BARRA	BZ21136108	ACREUNA	12/12/2020 12:03	12/12/2020 15:25	12/12/2020 12:03	12/12/2020 15:25	3,36	1	3,36	CHI
20201266282	SANTA ROSA DE GOIAS	SR12018997	INHUMAS S1	12/12/2020 12:05	12/12/2020 14:45	12/12/2020 12:05	12/12/2020 14:45	2,67	2	5,33	CHI
20201266282	ITAUCU	SR12018997	INHUMAS S1	12/12/2020 12:05	12/12/2020 14:45	12/12/2020 12:05	12/12/2020 14:45	2,67	5	13,33	CHI
20201266285	APARECIDA DE GOIANIA	10030926589	INDEPENDENCIA S1	12/12/2020 12:05	12/12/2020 15:16	12/12/2020 12:05	12/12/2020 15:16	3,18	1	3,18	CHI
20201266292	GOIANIA	10013794785	CARAJAS S1	12/12/2020 12:05	12/12/2020 15:03	12/12/2020 12:05	12/12/2020 15:03	2,96	1	2,96	CHI
20201266449	TROMBAS	TB12256991	PORANGATU	12/12/2020 12:06	13/12/2020 07:05	12/12/2020 12:06	13/12/2020 07:05	18,98	22	417,46	CHI
20201266449	MINACU	TB12256991	PORANGATU	12/12/2020 12:06	13/12/2020 07:05	12/12/2020 12:06	13/12/2020 07:05	18,98	12	227,71	CHI
20201266308	FORMOSA	FA12206227	ITUIQUIRA	12/12/2020 12:08	12/12/2020 16:25	12/12/2020 12:08	12/12/2020 16:25	4,28	27	115,56	CHI
20201266309	NIQUELANDIA	NQ21073070	NIQUELANDIA SUBTRANSMISSAO	12/12/2020 12:09	13/12/2020 08:01	12/12/2020 12:09	13/12/2020 08:01	19,86	1	19,86	CHI
20201266311	IPORA	730076027	IPORA	12/12/2020 12:09	12/12/2020 15:42	12/12/2020 12:09	12/12/2020 15:42	3,55	1	3,55	CHI
20201266330	ITABERAI	IB12310510	ITABERAI S2	12/12/2020 12:12	12/12/2020 15:02	12/12/2020 12:12	12/12/2020 15:02	2,82	1	2,82	CHI
20201266334	IPAMERI	IP21195210	IPAMERI	12/12/2020 12:13	12/12/2020 14:44	12/12/2020 12:13	12/12/2020 14:44	2,51	1	2,51	CHI
20201266340	CRISTALINA	KR11283785	CRISTALINA S1	12/12/2020 12:15	12/12/2020 14:56	12/12/2020 12:15	12/12/2020 14:56	2,67	215	573,63	CHI
20201266341	ANAPOLIS	AN21261145	ANAPOLIS UNIVERSITARIO S2	12/12/2020 12:15	12/12/2020 16:50	12/12/2020 12:15	12/12/2020 16:50	4,57	1	4,57	CHI
20201266342	TRINDADE	40118514	TRINDADE	12/12/2020 12:16	12/12/2020 16:10	12/12/2020 12:16	12/12/2020 16:10	3,90	1	3,90	CHI
20201266721	NIQUELANDIA	NQ12317176	NIQUELANDIA SUBTRANSMISSAO	12/12/2020 12:16	12/12/2020 16:43	12/12/2020 12:16	12/12/2020 16:43	4,44	78	346,28	CHI
20201266349	APARECIDA DE GOIANIA	15615730	INDEPENDENCIA S2	12/12/2020 12:17	12/12/2020 15:27	12/12/2020 12:17	12/12/2020 15:27	3,17	1	3,17	CHI
20201266355	SENADOR CANEDO	190093730	SENADOR CANEDO	12/12/2020 12:18	12/12/2020 14:38	12/12/2020 12:18	12/12/2020 14:38	2,34	1	2,34	CHI
20201266378	MINACU	01970224	MINACU	12/12/2020 12:18	12/12/2020 17:47	12/12/2020 12:20	12/12/2020 17:34	5,23	6038	31608,93	CHI

20201266378	MINACU	01970214	MINACU	12/12/2020 12:18	12/12/2020 17:47	12/12/2020 12:20	12/12/2020 17:47	5,45	4474	24362,17	CHI
20201266359	GOIANIA	11479980	GOIANIA LESTE S1	12/12/2020 12:19	13/12/2020 03:51	12/12/2020 12:19	13/12/2020 03:51	15,52	1	15,52	CHI
20201266647	CABECEIRAS	CW12154467	ITUIQUIRA	12/12/2020 12:19	12/12/2020 17:30	12/12/2020 12:19	12/12/2020 17:30	5,17	36	186,26	CHI
20201266647	FORMOSA	CW12154467	ITUIQUIRA	12/12/2020 12:19	12/12/2020 17:30	12/12/2020 12:19	12/12/2020 17:30	5,17	3	15,52	CHI
20201266364	CAIAPONIA	CP21239374	CAIAPONIA	12/12/2020 12:20	12/12/2020 23:21	12/12/2020 12:20	12/12/2020 23:21	11,00	1	11,00	CHI
20201266477	LUZIANIA	LZ12110889	RIO VERMELHO	12/12/2020 12:20	12/12/2020 19:50	12/12/2020 12:20	12/12/2020 19:50	7,49	7	52,40	CHI
20201266366	PIRES DO RIO	PR21083232	PIRES DO RIO S1	12/12/2020 12:22	12/12/2020 14:58	12/12/2020 12:22	12/12/2020 14:58	2,59	1	2,59	CHI
20201266368	CRIXAS	2490019205	SERRA DO OURO	12/12/2020 12:22	13/12/2020 02:26	12/12/2020 12:22	13/12/2020 02:26	14,05	1	14,05	CHI
20201266369	DAMOLANDIA	DL12384816	INHUMAS S1	12/12/2020 12:23	12/12/2020 17:59	12/12/2020 12:23	12/12/2020 17:59	5,60	33	184,70	CHI
20201266369	PETROLINA DE GOIAS	DL12384816	INHUMAS S1	12/12/2020 12:23	12/12/2020 17:59	12/12/2020 12:23	12/12/2020 17:59	5,60	6	33,58	CHI
20201266369	OURO VERDE DE GOIAS	DL12384816	INHUMAS S1	12/12/2020 12:23	12/12/2020 17:59	12/12/2020 12:23	12/12/2020 17:59	5,60	12	67,16	CHI
20201266372	CRISTALINA	KR21248356	CRISTALINA S2	12/12/2020 12:23	12/12/2020 15:32	12/12/2020 12:23	12/12/2020 15:32	3,14	1	3,14	CHI
20201267341	MINACU	IH12088797	MINACU	12/12/2020 12:24	12/12/2020 18:50	12/12/2020 12:24	12/12/2020 18:50	6,43	178	1144,69	CHI
20201266381	JATAI	290001950	JATAI S2	12/12/2020 12:25	12/12/2020 13:51	12/12/2020 12:25	12/12/2020 13:51	1,43	1	1,43	CHI
20201267234	GOIANDIRA	GD21000014	CATALAO S1	12/12/2020 12:26	12/12/2020 16:15	12/12/2020 12:26	12/12/2020 16:15	3,80	2	7,60	CHI
20201266388	ANAPOLIS	10007969846	ANAPOLIS UNIVERSITARIO S2	12/12/2020 12:28	12/12/2020 14:10	12/12/2020 12:28	12/12/2020 14:10	1,70	1	1,70	CHI
20201266401	MONTIVIDIU DO NORTE	MX21315472	PORANGATU	12/12/2020 12:31	13/12/2020 13:11	12/12/2020 12:31	13/12/2020 13:11	24,66	1	24,66	CHI
20201266813	PORANGATU	PO21246532	NOVO PLANALTO	12/12/2020 12:33	13/12/2020 00:02	12/12/2020 12:33	13/12/2020 00:02	11,47	1	11,47	CHI
20201267014	PORANGATU	PO12064911	NOVO PLANALTO	12/12/2020 12:33	12/12/2020 21:06	12/12/2020 12:33	12/12/2020 21:06	8,54	134	1143,84	CHI
20201266411	APARECIDA DE GOIANIA	12279559	INDEPENDENCIA S2	12/12/2020 12:35	12/12/2020 14:53	12/12/2020 12:35	12/12/2020 14:53	2,29	1	2,29	CHI
20201266824	ABADIANIA	AA12333151	DAIA S2	12/12/2020 12:36	12/12/2020 23:32	12/12/2020 12:36	12/12/2020 23:32	10,92	25	272,97	CHI
20201266417	CROMINIA	CQ11000026	PONTALINA	12/12/2020 12:37	12/12/2020 13:10	12/12/2020 12:37	12/12/2020 13:10	0,53	102	54,54	CHI
20201266422	RIO VERDE	RV21260144	RIO VERDE S2	12/12/2020 12:39	12/12/2020 14:25	12/12/2020 12:39	12/12/2020 14:25	1,75	1	1,75	CHI
20201266424	FORMOSA	FA12397036	ITUIQUIRA	12/12/2020 12:40	13/12/2020 18:39	12/12/2020 12:40	13/12/2020 18:39	29,99	3	89,96	CHI
20201266838	PORANGATU	PO12189555	PORANGATU	12/12/2020 12:40	13/12/2020 04:21	12/12/2020 12:40	13/12/2020 04:21	15,67	8	125,37	CHI
20201266433	MONTIVIDIU DO NORTE	TB21146548	PORANGATU	12/12/2020 12:42	13/12/2020 10:58	12/12/2020 12:42	13/12/2020 10:58	22,26	1	22,26	CHI
20201266436	APARECIDA DE GOIANIA	200089481	INDEPENDENCIA S2	12/12/2020 12:42	12/12/2020 15:03	12/12/2020 12:42	12/12/2020 15:03	2,34	1	2,34	CHI
20201266438	CAMPINORTE	CR11099002	PORANGATU	12/12/2020 12:42	13/12/2020 04:03	12/12/2020 12:42	13/12/2020 04:03	15,34	38	582,89	CHI
20201266901	JARAGUA	JA12221352	JARAGUA	12/12/2020 12:42	13/12/2020 01:01	12/12/2020 12:42	13/12/2020 01:01	12,31	56	689,22	CHI
20201266451	APORE	AE21162674	ITAJA S1	12/12/2020 12:44	12/12/2020 17:55	12/12/2020 12:44	12/12/2020 17:55	5,17	1	5,17	CHI
20201266452	CRISTALINA	KR12160112	CRISTALINA S2	12/12/2020 12:44	12/12/2020 18:13	12/12/2020 12:44	12/12/2020 18:13	5,48	18	98,69	CHI
20201266462	CUMARI	CY21358263	CATALAO S2	12/12/2020 12:44	12/12/2020 20:00	12/12/2020 12:44	12/12/2020 20:00	7,26	1	7,26	CHI
20201266455	MINACU	IH11348011	MINACU	12/12/2020 12:45	13/12/2020 09:49	12/12/2020 12:45	13/12/2020 09:49	21,06	1	21,06	CHI
20201266468	SAO JOAO D ALIANCA	JL12348100LD	SAO JOAO D ALIANCA	12/12/2020 12:47	12/12/2020 13:06	12/12/2020 12:47	12/12/2020 13:06	0,31	1	0,31	CHI
20201266475	PALMEIRAS DE GOIAS	590071026	PALMEIRAS	12/12/2020 12:48	13/12/2020 11:49	12/12/2020 12:48	13/12/2020 11:49	23,01	1	23,01	CHI
20201266501	GOIANIA	GN11038696	FERROVIARIO S2	12/12/2020 12:49	12/12/2020 21:15	12/12/2020 12:49	12/12/2020 21:15	8,42	144	1212,96	CHI
20201267020	OURO VERDE DE GOIAS	6331432	NEROPOLIS S2	12/12/2020 12:52	13/12/2020 11:35	12/12/2020 12:52	13/12/2020 11:35	22,71	8	181,67	CHI
20201266500	JATAI	290347336	JATAI S3	12/12/2020 12:53	12/12/2020 16:55	12/12/2020 12:53	12/12/2020 16:55	4,03	1	4,03	CHI
20201266503	APARECIDA DE GOIANIA	11714566	INDEPENDENCIA S2	12/12/2020 12:53	12/12/2020 16:12	12/12/2020 12:53	12/12/2020 16:12	3,31	1	3,31	CHI
20201266510	VILA BOA	FA12042058	ITUIQUIRA	12/12/2020 12:54	12/12/2020 13:34	12/12/2020 12:54	12/12/2020 13:34	0,66	2	1,31	CHI
20201266511	VILA BOA	FA21106893	ITUIQUIRA	12/12/2020 12:54	12/12/2020 16:56	12/12/2020 12:54	12/12/2020 16:56	4,02	1	4,02	CHI
20201266518	PIRACANJUBA	PJ12092434	BELA VISTA S1	12/12/2020 12:54	13/12/2020 06:49	12/12/2020 12:54	13/12/2020 06:49	17,91	3	53,73	CHI
20201266710	MONTE ALEGRE DE GOIAS	MA12280267	SAO DOMINGOS	12/12/2020 12:54	12/12/2020 20:35	12/12/2020 12:54	12/12/2020 20:35	7,67	13	99,68	CHI
20201266710	CAVALCANTE	MA12280267	SAO DOMINGOS	12/12/2020 12:54	12/12/2020 20:35	12/12/2020 12:54	12/12/2020 20:35	7,67	174	1334,19	CHI
20201266515	DAVINOPOLIS	IO12073875RE	CATALAO S1	12/12/2020 12:56	12/12/2020 17:44	12/12/2020 12:56	12/12/2020 17:44	4,79	17	81,43	CHI
20201266705	ITAJA	IJ12226574	ITAJA S2	12/12/2020 12:56	12/12/2020 16:54	12/12/2020 12:56	12/12/2020 16:54	3,96	8	31,70	CHI
20201266519	TRINDADE	10004350110	TRINDADE	12/12/2020 12:57	12/12/2020 14:30	12/12/2020 12:57	12/12/2020 14:30	1,55	1	1,55	CHI
20201266520	CROMINIA	CQ12000204	PONTALINA	12/12/2020 12:57	12/12/2020 17:45	12/12/2020 12:57	12/12/2020 14:42	1,77	407	718,69	CHI
20201266520	CROMINIA	CQ12000231LD	PONTALINA	12/12/2020 12:57	12/12/2020 17:45	12/12/2020 12:57	12/12/2020 17:45	4,82	12	57,78	CHI
20201266608	ANAPOLIS	AN12262491	ANAPOLIS UNIVERSITARIO S1	12/12/2020 12:57	12/12/2020 16:29	12/12/2020 12:57	12/12/2020 16:29	3,52	40	140,71	CHI
20201266529	VILA BOA	VB21235781	IACIARA S2	12/12/2020 12:58	12/12/2020 18:11	12/12/2020 12:58	12/12/2020 18:11	5,20	2	10,41	CHI

20201266531	COCALZINHO DE GOIAS	ZN12043653	COCALZINHO	12/12/2020 12:59	12/12/2020 15:51	12/12/2020 12:59	12/12/2020 15:51	2,86	11	31,51	CHI
20201266535	GOIANIA	16795982	CARAJAS S1	12/12/2020 13:00	12/12/2020 14:19	12/12/2020 13:00	12/12/2020 14:19	1,30	1	1,30	CHI
20201267152	PANAMA	BJ12000207	CACHOEIRA DOURADA	12/12/2020 13:02	13/12/2020 10:18	12/12/2020 13:02	13/12/2020 10:18	21,25	2	42,51	CHI
20201267152	GOIATUBA	BJ12000207	CACHOEIRA DOURADA	12/12/2020 13:02	13/12/2020 10:18	12/12/2020 13:02	13/12/2020 10:18	21,25	1	21,25	CHI
20201267152	BOM JESUS DE GOIAS	BJ12000207	CACHOEIRA DOURADA	12/12/2020 13:02	13/12/2020 10:18	12/12/2020 13:02	13/12/2020 10:18	21,25	4	85,01	CHI
20201266553	MORRO AGUDO DE GOIAS	MS21335826	ITAPURANGA	12/12/2020 13:03	12/12/2020 17:15	12/12/2020 13:03	12/12/2020 17:15	4,19	1	4,19	CHI
20201266554	APARECIDA DE GOIANIA	10020726579	INDEPENDENCIA S1	12/12/2020 13:03	12/12/2020 15:41	12/12/2020 13:03	12/12/2020 15:41	2,63	1	2,63	CHI
20201266570	URUACU	UR12317135	URUACU	12/12/2020 13:03	12/12/2020 17:52	12/12/2020 13:03	12/12/2020 17:52	4,81	11	52,86	CHI
20201266560	HIDROLANDIA	HD21200018	CEPAIGO S2	12/12/2020 13:04	12/12/2020 14:33	12/12/2020 13:04	12/12/2020 14:33	1,48	2	2,95	CHI
20201266561	PLANALTINA	2960159397	PLANALTINA	12/12/2020 13:04	12/12/2020 17:01	12/12/2020 13:04	12/12/2020 17:01	3,94	1	3,94	CHI
20201266581	TROMBAS	TB12185317	PORANGATU	12/12/2020 13:04	12/12/2020 23:00	12/12/2020 13:04	12/12/2020 23:00	9,92	1	9,92	CHI
20201266581	FORMOSO	TB12185317	PORANGATU	12/12/2020 13:04	12/12/2020 23:00	12/12/2020 13:04	12/12/2020 23:00	9,92	5	49,61	CHI
20201266564	NOVO GAMA	2460085248	PACAEMBU S1	12/12/2020 13:05	12/12/2020 14:53	12/12/2020 13:05	12/12/2020 14:53	1,79	1	1,79	CHI
20201266566	INACIOLANDIA	ID21016425	QUIRINOPOLIS	12/12/2020 13:05	12/12/2020 15:02	12/12/2020 13:05	12/12/2020 15:02	1,94	1	1,94	CHI
20201267411	CROMINIA	CQ12000304RE	PONTALINA	12/12/2020 13:07	12/12/2020 18:48	12/12/2020 13:07	12/12/2020 18:48	5,68	25	141,94	CHI
20201266583	BONOPOLIS	TA12263013	NOVO PLANALTO	12/12/2020 13:08	13/12/2020 10:12	12/12/2020 13:08	13/12/2020 08:26	19,29	1	19,29	CHI
20201266583	BONOPOLIS	TA12263013	NOVO PLANALTO	12/12/2020 13:08	13/12/2020 10:12	12/12/2020 13:08	13/12/2020 10:12	21,07	30	632,08	CHI
20201266820	CATALAO	CT12010458	CATALAO S2	12/12/2020 13:08	12/12/2020 16:46	12/12/2020 13:08	12/12/2020 16:46	3,63	7	25,40	CHI
20201266820	CUMARI	CT12010458	CATALAO S2	12/12/2020 13:08	12/12/2020 16:46	12/12/2020 13:08	12/12/2020 16:46	3,63	10	36,29	CHI
20201266613	HIDROLANDIA	HD12006326	CEPAIGO S2	12/12/2020 13:12	12/12/2020 16:15	12/12/2020 13:12	12/12/2020 16:15	3,04	60	182,18	CHI
20201266697	CAMPINACU	IH12132432	MINACU	12/12/2020 13:12	12/12/2020 19:55	12/12/2020 13:12	12/12/2020 19:55	6,70	22	147,49	CHI
20201266697	MINACU	IH12132432	MINACU	12/12/2020 13:12	12/12/2020 19:55	12/12/2020 13:12	12/12/2020 19:55	6,70	106	710,61	CHI
20201266699	JESUPOLIS	SF12066036	SAO FRANCISCO DE GOIAS	12/12/2020 13:12	12/12/2020 17:18	12/12/2020 13:12	12/12/2020 17:18	4,08	16	65,36	CHI
20201266616	IPORA	730074420	IPORA	12/12/2020 13:13	12/12/2020 16:45	12/12/2020 13:13	12/12/2020 16:45	3,54	1	3,54	CHI
20201266618	PLANALTINA	PI21150800	PLANALTINA	12/12/2020 13:13	12/12/2020 18:31	12/12/2020 13:13	12/12/2020 18:31	5,29	1	5,29	CHI
20201266628	MOSSAMEDES	MD12005317	FIRMINOPOLIS S2	12/12/2020 13:15	12/12/2020 15:37	12/12/2020 13:15	12/12/2020 15:37	2,36	16	37,70	CHI
20201266939	SERRANOPOLIS	SX12166076	JATAI S1	12/12/2020 13:15	12/12/2020 19:36	12/12/2020 13:15	12/12/2020 19:36	6,34	11	69,76	CHI
20201266630	SIMOLANDIA	SA12180855	IACIARA S2	12/12/2020 13:16	12/12/2020 17:25	12/12/2020 13:16	12/12/2020 17:25	4,15	234	971,62	CHI
20201266634	ITAGUARU	IC21250503	ITAPURANGA	12/12/2020 13:16	12/12/2020 17:56	12/12/2020 13:16	12/12/2020 17:56	4,66	1	4,66	CHI
20201267184	MINACU	IH12207727	MINACU	12/12/2020 13:16	12/12/2020 21:09	12/12/2020 13:16	12/12/2020 21:09	7,87	5	39,36	CHI
20201266639	SAO JOAO D ALIANCA	JL11238274	ITUIQUIRA	12/12/2020 13:18	13/12/2020 08:27	12/12/2020 13:18	13/12/2020 08:27	19,15	1	19,15	CHI
20201266640	QUIRINOPOLIS	QI32255692	QUIRINOPOLIS	12/12/2020 13:18	12/12/2020 16:44	12/12/2020 13:18	12/12/2020 16:44	3,43	18	61,68	CHI
20201269794	CAMPINACU	UC12236261	PORANGATU	12/12/2020 13:18	13/12/2020 07:49	12/12/2020 13:18	13/12/2020 07:49	18,51	22	407,21	CHI
20201269794	PORANGATU	UC12236261	PORANGATU	12/12/2020 13:18	13/12/2020 07:49	12/12/2020 13:18	13/12/2020 07:49	18,51	1	18,51	CHI
20201266743	CUMARI	CY12071536	CATALAO S1	12/12/2020 13:19	12/12/2020 18:38	12/12/2020 13:19	12/12/2020 18:38	5,31	2	10,62	CHI
20201265945	APARECIDA DO RIO DOCE	AW12311820	CACHOEIRA ALTA	12/12/2020 13:20	12/12/2020 16:21	12/12/2020 13:20	12/12/2020 16:21	3,01	4	12,02	CHI
20201266649	MOZARLANDIA	MZ21147384	MOZARLANDIA	12/12/2020 13:20	13/12/2020 00:53	12/12/2020 13:20	13/12/2020 00:53	11,54	1	11,54	CHI
20201266650	FORMOSA	FA21194770	ITUIQUIRA	12/12/2020 13:20	12/12/2020 14:40	12/12/2020 13:20	12/12/2020 14:40	1,32	1	1,32	CHI
20201266651	ANAPOLIS	AN21062668	ANAPOLIS UNIVERSITARIO S2	12/12/2020 13:21	12/12/2020 15:03	12/12/2020 13:21	12/12/2020 15:03	1,69	1	1,69	CHI
20201266652	GOIANIA	10024403480	CARAJAS S2	12/12/2020 13:21	12/12/2020 15:54	12/12/2020 13:21	12/12/2020 15:54	2,54	1	2,54	CHI
20201266655	CORUMBAIBA	CI12252062	VILA CORUMBA	12/12/2020 13:22	12/12/2020 17:57	12/12/2020 13:22	12/12/2020 17:57	4,58	2	9,16	CHI
20201266663	NIQUELANDIA	NQ21253730	URUACU	12/12/2020 13:22	14/12/2020 11:06	12/12/2020 13:22	14/12/2020 11:06	45,73	2	91,46	CHI
20201266658	PADRE BERNARDO	PB12377250	PADRE BERNARDO	12/12/2020 13:23	12/12/2020 14:59	12/12/2020 13:23	12/12/2020 14:59	1,59	13	20,64	CHI
20201266837	SAO MIGUEL DO ARAGUAIA	SM12013236	SAO MIGUEL DO ARAGUAIA	12/12/2020 13:24	13/12/2020 16:30	12/12/2020 13:24	13/12/2020 16:30	27,10	28	758,76	CHI
20201266700	GOIANDIRA	GD12000012	CATALAO S1	12/12/2020 13:25	13/12/2020 00:54	12/12/2020 13:25	13/12/2020 00:54	11,48	16	183,65	CHI
20201266960	SAO DOMINGOS	SD12161805	SAO DOMINGOS	12/12/2020 13:25	12/12/2020 16:41	12/12/2020 13:25	12/12/2020 16:41	3,26	50	163,24	CHI
20201266673	ANAPOLIS	AN11346901	JUNDIAI S1	12/12/2020 13:27	12/12/2020 17:03	12/12/2020 13:27	12/12/2020 17:03	3,60	34	122,27	CHI
20201266675	ITAPURANGA	170043320	ITAPURANGA	12/12/2020 13:27	13/12/2020 07:12	12/12/2020 13:27	13/12/2020 07:12	17,74	1	17,74	CHI
20201266677	MORRINHOS	MR21246562	GOIATUBA S1	12/12/2020 13:27	12/12/2020 16:16	12/12/2020 13:27	12/12/2020 16:16	2,81	1	2,81	CHI
20201266836	PROFESSOR JAMIL SAFADY	PJ12293365	PIRACANJUBA	12/12/2020 13:27	13/12/2020 07:45	12/12/2020 13:27	13/12/2020 07:45	18,29	3	54,88	CHI
20201266879	DIORAMA	DI12023266RE	IPORA	12/12/2020 13:28	12/12/2020 16:55	12/12/2020 13:28	12/12/2020 16:55	3,43	45	154,56	CHI

20201266879	JAUPACI	DI12023266RE	IPORA	12/12/2020 13:28	12/12/2020 16:55	12/12/2020 13:28	12/12/2020 16:55	3,43	9	30,91	CHI
20201266886	BONOPOLIS	BX12192399	SAO MIGUEL DO ARAGUAIA	12/12/2020 13:29	12/12/2020 18:20	12/12/2020 13:29	12/12/2020 18:20	4,84	5	24,21	CHI
20201266693	FORMOSA	10005455446	ITUIQUIRA	12/12/2020 13:30	12/12/2020 22:55	12/12/2020 13:30	12/12/2020 22:55	9,40	1	9,40	CHI
20201266696	CAVALCANTE	CJ12063197	FLORES DE GOIAS	12/12/2020 13:31	12/12/2020 16:30	12/12/2020 13:31	12/12/2020 16:30	2,98	1	2,98	CHI
20201266899	MAIRIPOTABA	MI12000231	PONTALINA	12/12/2020 13:31	12/12/2020 15:56	12/12/2020 13:31	12/12/2020 15:56	2,41	1	2,41	CHI
20201266899	PROFESSOR JAMIL SAFADY	MI12000231	PONTALINA	12/12/2020 13:31	12/12/2020 15:56	12/12/2020 13:31	12/12/2020 15:56	2,41	14	33,77	CHI
20201266702	GOIANIA	10281071	CAMPINAS S2	12/12/2020 13:33	12/12/2020 15:18	12/12/2020 13:33	12/12/2020 15:18	1,75	1	1,75	CHI
20201266703	PORANGATU	2500014983	NOVO PLANALTO	12/12/2020 13:33	13/12/2020 00:06	12/12/2020 13:33	13/12/2020 00:06	10,55	1	10,55	CHI
20201266704	BOM JARDIM DE GOIAS	1880009034	BOM JARDIM	12/12/2020 13:33	12/12/2020 15:27	12/12/2020 13:33	12/12/2020 15:27	1,89	1	1,89	CHI
20201267009	CATALAO	CT12130972	CATALAO S2	12/12/2020 13:33	12/12/2020 16:28	12/12/2020 13:33	12/12/2020 16:28	2,90	27	78,34	CHI
20201267009	CUMARI	CT12130972	CATALAO S2	12/12/2020 13:33	12/12/2020 16:28	12/12/2020 13:33	12/12/2020 16:28	2,90	1	2,90	CHI
20201266714	DIVINOPOLIS DE GOIAS	SD12266366	SAO DOMINGOS	12/12/2020 13:36	12/12/2020 15:30	12/12/2020 13:36	12/12/2020 15:30	1,89	2	3,77	CHI
20201266714	SAO DOMINGOS	SD12266366	SAO DOMINGOS	12/12/2020 13:36	12/12/2020 15:30	12/12/2020 13:36	12/12/2020 15:30	1,89	3	5,66	CHI
20201266715	MINEIROS	MY21364405	PARQUE DAS EMAS	12/12/2020 13:38	12/12/2020 15:56	12/12/2020 13:38	12/12/2020 15:56	2,30	1	2,30	CHI
20201266756	PROFESSOR JAMIL SAFADY	PJ12063207	ROCHEDO	12/12/2020 13:38	12/12/2020 20:17	12/12/2020 13:38	12/12/2020 20:17	6,65	16	106,36	CHI
20201267613	ORIZONA	OZ12114505	PIRES DO RIO S2	12/12/2020 13:40	12/12/2020 21:36	12/12/2020 13:40	12/12/2020 21:36	7,93	20	158,51	CHI
20201266727	MONTES CLAROS DE GOIAS	ME21353749	IPORA	12/12/2020 13:41	13/12/2020 22:52	12/12/2020 13:41	13/12/2020 22:52	33,18	2	66,36	CHI
20201266874	MINACU	IH12341443LD	MINACU	12/12/2020 13:42	12/12/2020 23:17	12/12/2020 13:42	12/12/2020 23:17	9,57	315	3014,64	CHI
20201267155	SERRANOPOLIS	SX12080873RE	JATAI S1	12/12/2020 13:42	12/12/2020 19:00	12/12/2020 13:42	12/12/2020 19:00	5,29	25	132,30	CHI
20201267155	JATAI	SX12080873RE	JATAI S1	12/12/2020 13:42	12/12/2020 19:00	12/12/2020 13:42	12/12/2020 19:00	5,29	77	407,48	CHI
20201267473	URUACU	UR12082989	URUACU	12/12/2020 13:42	13/12/2020 07:48	12/12/2020 13:42	13/12/2020 07:48	18,09	6	108,55	CHI
20201266736	SAO MIGUEL DO ARAGUAIA	SM12020668	SAO MIGUEL DO ARAGUAIA	12/12/2020 13:43	12/12/2020 16:00	12/12/2020 13:43	12/12/2020 16:00	2,27	13	29,48	CHI
20201270506	PIRACANJUBA	PJ12223396	ROCHEDO	12/12/2020 13:43	13/12/2020 09:37	12/12/2020 13:43	13/12/2020 09:37	19,89	3	59,68	CHI
20201266744	CABECEIRAS	CW21184649	ITUIQUIRA	12/12/2020 13:44	13/12/2020 07:42	12/12/2020 13:44	13/12/2020 07:42	17,95	1	17,95	CHI
20201266745	LEOPOLDO DE BULHOES	LB21129352	DAIA S2	12/12/2020 13:45	12/12/2020 17:28	12/12/2020 13:45	12/12/2020 17:28	3,72	1	3,72	CHI
20201266747	PETROLINA DE GOIAS	320039365	PETROLINA	12/12/2020 13:45	14/12/2020 00:11	12/12/2020 13:45	14/12/2020 00:11	34,43	1	34,43	CHI
20201266749	MARA ROSA	MQ12051070	MARA ROSA	12/12/2020 13:45	12/12/2020 14:31	12/12/2020 13:45	12/12/2020 14:31	0,76	196	148,31	CHI
20201266755	CAMPINORTE	MQ12055222	MARA ROSA	12/12/2020 13:46	12/12/2020 16:20	12/12/2020 13:46	12/12/2020 16:20	2,56	5	12,81	CHI
20201266755	MARA ROSA	MQ12055222	MARA ROSA	12/12/2020 13:46	12/12/2020 16:20	12/12/2020 13:46	12/12/2020 16:20	2,56	1	2,56	CHI
20201266757	IPORA	IR21089258	ARENOPOLIS	12/12/2020 13:46	12/12/2020 14:39	12/12/2020 13:46	12/12/2020 14:39	0,87	1	0,87	CHI
20201266759	ITABERAI	I0012608538	ITABERAI S2	12/12/2020 13:46	12/12/2020 16:13	12/12/2020 13:46	12/12/2020 16:13	2,44	1	2,44	CHI
20201268738	MIMOSO DE GOIAS	NQ12207364	BARRO ALTO	12/12/2020 13:46	14/12/2020 17:25	12/12/2020 13:46	12/12/2020 22:46	8,99	4	35,97	CHI
20201268738	NIQUELANDIA	NQ12207364	BARRO ALTO	12/12/2020 13:46	14/12/2020 17:25	12/12/2020 13:46	12/12/2020 22:46	8,99	16	143,87	CHI
20201268738	NIQUELANDIA	NQ12207363LD	BARRO ALTO	12/12/2020 13:46	14/12/2020 17:25	12/12/2020 13:46	14/12/2020 17:25	51,64	11	568,00	CHI
20201266760	QUIRINOPOLIS	QI21315192	QUIRINOPOLIS	12/12/2020 13:47	12/12/2020 19:49	12/12/2020 13:47	12/12/2020 19:49	6,04	1	6,04	CHI
20201267459	HIDROLINA	HL11269761	URUACU	12/12/2020 13:48	12/12/2020 22:39	12/12/2020 13:48	12/12/2020 22:39	8,84	69	610,02	CHI
20201267324	GOIANIA	GN11340563	GOYA S2	12/12/2020 13:50	12/12/2020 16:28	12/12/2020 13:50	12/12/2020 16:28	2,62	65	170,52	CHI
20201266778	RIO VERDE	RV21189235	CABRIUVA S1	12/12/2020 13:51	12/12/2020 17:28	12/12/2020 13:51	12/12/2020 17:28	3,62	1	3,62	CHI
20201266781	ITARUMA	IM21219279	ITAJA S2	12/12/2020 13:51	12/12/2020 17:22	12/12/2020 13:51	12/12/2020 17:22	3,50	1	3,50	CHI
20201266783	MONTIVIDIU DO NORTE	MX12187848	PORANGATU	12/12/2020 13:52	12/12/2020 16:25	12/12/2020 13:52	12/12/2020 16:25	2,55	15	38,23	CHI
20201266783	TROMBAS	MX12187848	PORANGATU	12/12/2020 13:52	12/12/2020 16:25	12/12/2020 13:52	12/12/2020 16:25	2,55	1	2,55	CHI
20201266841	CAIAPONIA	CP12235316	PIRANHAS	12/12/2020 13:52	12/12/2020 16:50	12/12/2020 13:52	12/12/2020 16:50	2,95	6	17,73	CHI
20201266787	SERRANOPOLIS	SX21264306	CHAPADAO DO CEU	12/12/2020 13:53	13/12/2020 00:32	12/12/2020 13:53	13/12/2020 00:32	10,64	1	10,64	CHI
20201268316	ITAUCU	IN12282891	INHUMAS S2	12/12/2020 13:55	12/12/2020 20:17	12/12/2020 13:55	12/12/2020 20:17	6,36	35	222,46	CHI
20201268316	PETROLINA DE GOIAS	IN12282891	INHUMAS S2	12/12/2020 13:55	12/12/2020 20:17	12/12/2020 13:55	12/12/2020 20:17	6,36	2	12,71	CHI
20201268316	INHUMAS	IN12282891	INHUMAS S2	12/12/2020 13:55	12/12/2020 20:17	12/12/2020 13:55	12/12/2020 20:17	6,36	110	699,17	CHI
20201268316	SANTA ROSA DE GOIAS	IN12282891	INHUMAS S2	12/12/2020 13:55	12/12/2020 20:17	12/12/2020 13:55	12/12/2020 20:17	6,36	4	25,42	CHI
20201269852	CRIXAS	CX12319088	SERRA DO OURO	12/12/2020 13:55	13/12/2020 08:30	12/12/2020 13:55	13/12/2020 08:30	18,58	8	148,62	CHI
20201266796	URUACU	UR12066504	URUACU	12/12/2020 13:57	12/12/2020 16:27	12/12/2020 13:57	12/12/2020 16:27	2,49	7	17,45	CHI
20201266799	LUZIANIA	LZ21076060	RIO VERMELHO	12/12/2020 13:57	12/12/2020 14:34	12/12/2020 13:57	12/12/2020 14:34	0,60	1	0,60	CHI
20201266806	JATAI	JT12230959	JATAI S1	12/12/2020 13:59	12/12/2020 19:49	12/12/2020 13:59	12/12/2020 19:49	5,83	2	11,66	CHI

20201266816	TRES RANCHOS	10023476050	CATALAO S1	12/12/2020 14:02	12/12/2020 22:46	12/12/2020 14:02	12/12/2020 22:46	8,72	1	8,72	CHI
20201267078	COLINAS DO SUL	TI12357757	NIQUELANDIA SUBTRANSMISSAO	12/12/2020 14:02	13/12/2020 03:02	12/12/2020 14:02	13/12/2020 03:02	12,99	7	90,91	CHI
20201267549	UIRAPURU	UP12294696	NOVA CRIXAS	12/12/2020 14:02	13/12/2020 08:59	12/12/2020 14:02	13/12/2020 08:59	18,94	4	75,76	CHI
20201267549	SANTA TEREZINHA DE GOIAS	UP12294696	NOVA CRIXAS	12/12/2020 14:02	13/12/2020 08:59	12/12/2020 14:02	13/12/2020 08:59	18,94	1	18,94	CHI
20201267549	AMARALINA	UP12294696	NOVA CRIXAS	12/12/2020 14:02	13/12/2020 08:59	12/12/2020 14:02	13/12/2020 08:59	18,94	54	1022,79	CHI
20201267549	MARA ROSA	UP12294696	NOVA CRIXAS	12/12/2020 14:02	13/12/2020 08:59	12/12/2020 14:02	13/12/2020 08:59	18,94	47	890,21	CHI
20201266818	SAO JOAO DA PARAUNA	RP21008156	FIRMINOPOLIS S2	12/12/2020 14:03	12/12/2020 19:57	12/12/2020 14:03	12/12/2020 19:57	5,90	1	5,90	CHI
20201266822	FORMOSO	FO21294508	PORANGATU	12/12/2020 14:03	13/12/2020 00:43	12/12/2020 14:03	13/12/2020 00:43	10,65	1	10,65	CHI
20201266844	NIQUELANDIA	NQ12181068RE	URUACU	12/12/2020 14:03	12/12/2020 21:26	12/12/2020 14:03	12/12/2020 21:26	7,38	108	796,65	CHI
20201267665	NIQUELANDIA	NQ12243364RE	URUACU	12/12/2020 14:04	12/12/2020 22:10	12/12/2020 14:04	12/12/2020 22:10	8,09	27	218,54	CHI
20201267665	MARA ROSA	NQ12243364RE	URUACU	12/12/2020 14:04	12/12/2020 22:10	12/12/2020 14:04	12/12/2020 22:10	8,09	1	8,09	CHI
20201266828	MONTES CLAROS DE GOIAS	ME12088924	IPORA	12/12/2020 14:05	12/12/2020 18:51	12/12/2020 14:05	12/12/2020 18:51	4,76	2	9,52	CHI
20201266833	FORMOSA	FA10413228	ITIQUEIRA	12/12/2020 14:06	12/12/2020 18:33	12/12/2020 16:53	12/12/2020 18:33	1,68	16	26,80	CHI
20201266833	DISTRITO FEDERAL	FA10413228	ITIQUEIRA	12/12/2020 14:06	12/12/2020 18:33	12/12/2020 16:53	12/12/2020 18:33	1,68	2	3,35	CHI
20201266839	INHUMAS	30175604	INHUMAS S2	12/12/2020 14:07	12/12/2020 14:53	12/12/2020 14:07	12/12/2020 14:53	0,76	1	0,76	CHI
20201266840	LUZIANIA	LZ12261648	MARAJOARA	12/12/2020 14:07	12/12/2020 15:20	12/12/2020 14:07	12/12/2020 15:20	1,20	20	24,08	CHI
2020121200085	POSSE	00010424	IACIARA S2	12/12/2020 14:07	12/12/2020 14:11	12/12/2020 14:07	12/12/2020 14:11	0,07	82	5,47	CHI
2020121200085	SIMOLANDIA	00010424	IACIARA S2	12/12/2020 14:07	12/12/2020 14:11	12/12/2020 14:07	12/12/2020 14:11	0,07	253	16,87	CHI
2020121200085	ALVORADA DO NORTE	00010424	IACIARA S2	12/12/2020 14:07	12/12/2020 14:11	12/12/2020 14:07	12/12/2020 14:11	0,07	3	0,20	CHI
2020121200086	SITIO D ABADIA	42901	IACIARA S2	12/12/2020 14:07	12/12/2020 14:12	12/12/2020 14:07	12/12/2020 14:12	0,08	93	7,75	CHI
2020121200086	MAMBAI	49902	IACIARA S2	12/12/2020 14:07	12/12/2020 14:12	12/12/2020 14:07	12/12/2020 14:12	0,08	85	7,08	CHI
2020121200086	ALVORADA DO NORTE	00010434	IACIARA S2	12/12/2020 14:07	12/12/2020 14:12	12/12/2020 14:07	12/12/2020 14:12	0,08	183	15,25	CHI
2020121200086	MAMBAI	49901	IACIARA S2	12/12/2020 14:07	12/12/2020 14:12	12/12/2020 14:07	12/12/2020 14:12	0,08	2993	249,42	CHI
2020121200086	DAMIANOPOLIS	49902	IACIARA S2	12/12/2020 14:07	12/12/2020 14:12	12/12/2020 14:07	12/12/2020 14:12	0,08	1587	132,25	CHI
2020121200086	SITIO D ABADIA	00010434	IACIARA S2	12/12/2020 14:07	12/12/2020 14:12	12/12/2020 14:07	12/12/2020 14:12	0,08	37	3,08	CHI
2020121200086	SITIO D ABADIA	42902	IACIARA S2	12/12/2020 14:07	12/12/2020 14:12	12/12/2020 14:07	12/12/2020 14:12	0,08	532	44,33	CHI
2020121200086	MAMBAI	00010434	IACIARA S2	12/12/2020 14:07	12/12/2020 14:12	12/12/2020 14:07	12/12/2020 14:12	0,08	17	1,42	CHI
2020121200086	BURITINOPOLIS	49901	IACIARA S2	12/12/2020 14:07	12/12/2020 14:12	12/12/2020 14:07	12/12/2020 14:12	0,08	458	38,17	CHI
2020121200086	SITIO D ABADIA	49901	IACIARA S2	12/12/2020 14:07	12/12/2020 14:12	12/12/2020 14:07	12/12/2020 14:12	0,08	1	0,08	CHI
2020121200086	DAMIANOPOLIS	11101	IACIARA S2	12/12/2020 14:07	12/12/2020 14:12	12/12/2020 14:07	12/12/2020 14:12	0,08	135	11,25	CHI
2020121200086	BURITINOPOLIS	00010434	IACIARA S2	12/12/2020 14:07	12/12/2020 14:12	12/12/2020 14:07	12/12/2020 14:12	0,08	8	0,67	CHI
2020121200086	SITIO D ABADIA	11101	IACIARA S2	12/12/2020 14:07	12/12/2020 14:12	12/12/2020 14:07	12/12/2020 14:12	0,08	391	32,58	CHI
2020121200086	DAMIANOPOLIS	00010434	IACIARA S2	12/12/2020 14:07	12/12/2020 14:12	12/12/2020 14:07	12/12/2020 14:12	0,08	3	0,25	CHI
20201266845	PARAUNA	PU12167339	PARAUNA	12/12/2020 14:08	13/12/2020 14:26	12/12/2020 14:08	12/12/2020 19:03	4,91	4	19,64	CHI
20201266845	PARAUNA	PU12167339	PARAUNA	12/12/2020 14:08	13/12/2020 14:26	12/12/2020 19:04	12/12/2020 20:14	1,17	2	2,33	CHI
20201266845	PARAUNA	PU12260051	PARAUNA	12/12/2020 14:08	13/12/2020 14:26	12/12/2020 19:04	13/12/2020 14:26	19,36	2	38,73	CHI
20201267978	URUACU	UR12136438	URUACU	12/12/2020 14:08	12/12/2020 18:35	12/12/2020 14:08	12/12/2020 18:35	4,45	145	644,81	CHI
20201270558	UIRAPURU	UP21147900	NOVA CRIXAS	12/12/2020 14:08	13/12/2020 09:42	12/12/2020 14:08	13/12/2020 09:42	19,55	1	19,55	CHI
20201266867	MARA ROSA	MQ12390474	MARA ROSA	12/12/2020 14:09	12/12/2020 15:47	12/12/2020 14:09	12/12/2020 15:47	1,62	6	9,71	CHI
20201267018	MONTES CLAROS DE GOIAS	JR12212887	IPORA	12/12/2020 14:09	13/12/2020 01:25	12/12/2020 14:09	13/12/2020 01:25	11,26	7	78,80	CHI
20201267018	JUSSARA	JR12212887	IPORA	12/12/2020 14:09	13/12/2020 01:25	12/12/2020 14:09	13/12/2020 01:25	11,26	22	247,67	CHI
20201266872	APARECIDA DE GOIANIA	11553510	INDEPENDENCIA S2	12/12/2020 14:10	12/12/2020 16:38	12/12/2020 14:10	12/12/2020 16:38	2,45	1	2,45	CHI
20201267754	NIQUELANDIA	TI12239430	MINACU	12/12/2020 14:10	12/12/2020 22:15	12/12/2020 14:10	12/12/2020 22:15	8,08	1	8,08	CHI
20201267754	COLINAS DO SUL	TI12239430	MINACU	12/12/2020 14:10	12/12/2020 22:15	12/12/2020 14:10	12/12/2020 22:15	8,08	26	210,01	CHI
20201266876	CAVALCANTE	TI12162624	NIQUELANDIA SUBTRANSMISSAO	12/12/2020 14:11	13/12/2020 17:37	12/12/2020 14:11	13/12/2020 17:37	27,43	58	1590,71	CHI
20201266876	COLINAS DO SUL	TI12162624	NIQUELANDIA SUBTRANSMISSAO	12/12/2020 14:11	13/12/2020 17:37	12/12/2020 14:11	13/12/2020 17:37	27,43	18	493,67	CHI
20201267387	NIQUELANDIA	NQ12125441	NIQUELANDIA SUBTRANSMISSAO	12/12/2020 14:12	12/12/2020 21:51	12/12/2020 14:12	12/12/2020 21:51	7,63	63	480,95	CHI
20201266886	POSSE	PS12235404	IACIARA S2	12/12/2020 14:14	12/12/2020 15:47	12/12/2020 14:14	12/12/2020 15:47	1,54	32	49,34	CHI
20201266891	CAMPINACU	UC21181570	PORANGATU	12/12/2020 14:15	13/12/2020 10:47	12/12/2020 14:15	13/12/2020 10:47	20,53	1	20,53	CHI
20201266907	ALEXANIA	AX10404067	CORUMBA	12/12/2020 14:15	13/12/2020 01:16	12/12/2020 14:17	12/12/2020 15:51	1,57	93	146,09	CHI
20201266907	CORUMBA DE GOIAS	AX10404067	CORUMBA	12/12/2020 14:15	13/12/2020 01:16	12/12/2020 14:17	12/12/2020 15:51	1,57	59	92,68	CHI

20201266907	CORUMBA DE GOIAS	AX10404067	CORUMBA	12/12/2020 14:15	13/12/2020 01:16	12/12/2020 14:17	13/12/2020 01:16	10,99	295	3241,89	CHI
20201266907	ALEXANIA	AX10404067	CORUMBA	12/12/2020 14:15	13/12/2020 01:16	12/12/2020 14:17	13/12/2020 01:16	10,99	6	65,94	CHI
20201266894	RIO VERDE	630348674	CABRIUVA S1	12/12/2020 14:16	12/12/2020 18:06	12/12/2020 14:16	12/12/2020 18:06	3,82	1	3,82	CHI
20201266896	CRIXAS	CX21213600	MOZARLANDIA	12/12/2020 14:17	12/12/2020 18:57	12/12/2020 14:17	12/12/2020 18:57	4,67	1	4,67	CHI
20201266905	URUACU	UR11136413	URUACU	12/12/2020 14:17	12/12/2020 15:45	12/12/2020 14:17	12/12/2020 15:45	1,46	54	78,69	CHI
20201266910	CRISTALINA	KR21332509	CRISTALINA S2	12/12/2020 14:19	12/12/2020 17:47	12/12/2020 14:19	12/12/2020 17:47	3,46	1	3,46	CHI
20201266911	BELA VISTA DE GOIAS	BV32085133	BELA VISTA S1	12/12/2020 14:19	12/12/2020 16:55	12/12/2020 14:19	12/12/2020 16:55	2,59	103	266,80	CHI
20201266917	LUZIANIA	LZ21131825	PIRES DO RIO S2	12/12/2020 14:20	12/12/2020 21:40	12/12/2020 14:20	12/12/2020 21:40	7,32	1	7,32	CHI
20201266919	MONTIVIDIU DO NORTE	MX21060937	PORANGATU	12/12/2020 14:20	13/12/2020 13:56	12/12/2020 14:20	13/12/2020 13:56	23,59	1	23,59	CHI
20201268520	NIQUELANDIA	NQ12325206	NIQUELANDIA SUBTRANSMISSAO	12/12/2020 14:20	12/12/2020 19:01	12/12/2020 14:20	12/12/2020 19:01	4,67	251	1172,59	CHI
202012124567	ARENOPOLIS	AY12000026RE	ARENOPOLIS	12/12/2020 14:20	13/12/2020 16:11	12/12/2020 14:20	13/12/2020 00:16	9,94	29	288,39	CHI
202012124567	ARENOPOLIS	AY13380962	ARENOPOLIS	12/12/2020 14:20	13/12/2020 16:11	12/12/2020 14:20	13/12/2020 12:13	21,88	15	328,27	CHI
202012124567	ARENOPOLIS	AY12337174	ARENOPOLIS	12/12/2020 14:20	13/12/2020 16:11	12/12/2020 14:20	13/12/2020 15:21	25,03	8	200,20	CHI
202012124567	ARENOPOLIS	AY13103483	ARENOPOLIS	12/12/2020 14:20	13/12/2020 16:11	12/12/2020 14:20	13/12/2020 16:11	25,86	5	129,29	CHI
202012124567	PALESTINA DE GOIAS	AY13103483	ARENOPOLIS	12/12/2020 14:20	13/12/2020 16:11	12/12/2020 14:20	13/12/2020 16:11	25,86	3	77,57	CHI
20201267150	SAO MIGUEL DO PASSA QUATRO	SQ12039089	VIANOPOLIS	12/12/2020 14:21	12/12/2020 17:01	12/12/2020 14:21	12/12/2020 17:01	2,66	12	31,96	CHI
20201266925	RIO VERDE	RV21045262	MONTIVIDIU T	12/12/2020 14:22	12/12/2020 19:02	12/12/2020 14:22	12/12/2020 19:02	4,66	1	4,66	CHI
20201267090	ALTO HORIZONTE	VB12390494	SANTA TEREZINHA	12/12/2020 14:22	12/12/2020 18:06	12/12/2020 14:22	12/12/2020 18:06	3,72	9	33,50	CHI
20201267090	MARA ROSA	VD12390494	SANTA TEREZINHA	12/12/2020 14:22	12/12/2020 18:06	12/12/2020 14:22	12/12/2020 18:06	3,72	67	249,39	CHI
20201267090	CAMPOS VERDES	VD12390494	SANTA TEREZINHA	12/12/2020 14:22	12/12/2020 18:06	12/12/2020 14:22	12/12/2020 18:06	3,72	1	3,72	CHI
20201266929	MORRINHOS	MR21411587	MORRINHOS	12/12/2020 14:23	13/12/2020 01:45	12/12/2020 14:23	13/12/2020 01:45	11,36	1	11,36	CHI
20201266930	SAO JOAO DA PARAUNA	RP21026464	FIRMINOPOLIS S2	12/12/2020 14:23	12/12/2020 20:36	12/12/2020 14:23	12/12/2020 20:36	6,21	1	6,21	CHI
20201266961	AMORINOPOLIS	1240006461	IPORA	12/12/2020 14:26	12/12/2020 17:19	12/12/2020 14:26	12/12/2020 17:19	2,90	1	2,90	CHI
20201266945	CUMARI	CY12166827	CATALAO S1	12/12/2020 14:27	13/12/2020 12:51	12/12/2020 14:27	13/12/2020 12:51	22,39	1	22,39	CHI
20201266953	POSSE	PS11180899	IACIARA S2	12/12/2020 14:29	12/12/2020 16:18	12/12/2020 14:29	12/12/2020 16:18	1,81	12	21,68	CHI
20201267117	GOIANESIA	GE12000279	GOIANESIA S2	12/12/2020 14:29	13/12/2020 14:58	12/12/2020 14:29	13/12/2020 14:58	24,47	39	954,34	CHI
20201266962	HIDROLANDIA	HD21400522	PONTALINA	12/12/2020 14:30	12/12/2020 21:10	12/12/2020 14:30	12/12/2020 21:10	6,65	1	6,65	CHI
20201267425	PADRE BERNARDO	PB12305257	PADRE BERNARDO	12/12/2020 14:31	13/12/2020 02:54	12/12/2020 14:31	13/12/2020 02:54	12,37	5	61,86	CHI
20201267425	PLANALTINA	PB12305257	PADRE BERNARDO	12/12/2020 14:31	13/12/2020 02:54	12/12/2020 14:31	13/12/2020 02:54	12,37	69	853,63	CHI
20201268725	CAMPINACU	CR12410914	MARA ROSA	12/12/2020 14:31	12/12/2020 23:57	12/12/2020 14:31	12/12/2020 23:57	9,43	268	2526,05	CHI
20201268725	URUACU	CR12410914	MARA ROSA	12/12/2020 14:31	12/12/2020 23:57	12/12/2020 14:31	12/12/2020 23:57	9,43	28	263,92	CHI
20201267644	VALPARAISO DE GOIAS	VA12136669	PACAEMBU S1	12/12/2020 14:33	12/12/2020 17:32	12/12/2020 14:33	12/12/2020 17:32	2,97	133	395,08	CHI
20201266980	JARAGUA	JA21104707	JARAGUA	12/12/2020 14:34	13/12/2020 20:49	12/12/2020 14:34	13/12/2020 20:49	30,24	1	30,24	CHI
20201267095	FORMOSA	FA12361344	ITUIQUIRA	12/12/2020 14:34	12/12/2020 16:46	12/12/2020 14:34	12/12/2020 16:46	2,19	21	45,92	CHI
20201266982	APARECIDA DE GOIANIA	AP12193733	INDEPENDENCIA S1	12/12/2020 14:35	12/12/2020 17:13	12/12/2020 14:35	12/12/2020 17:13	2,63	154	404,81	CHI
20201267880	GOIANESIA	GE11090257	GOIANESIA S1	12/12/2020 14:35	13/12/2020 17:01	12/12/2020 14:35	13/12/2020 17:01	26,42	83	2193,14	CHI
20201268460	OURO VERDE DE GOIAS	OV12014230	INHUMAS S1	12/12/2020 14:36	13/12/2020 12:56	12/12/2020 14:36	13/12/2020 12:05	21,49	14	300,88	CHI
20201268460	OURO VERDE DE GOIAS	OV12014230	INHUMAS S1	12/12/2020 14:36	13/12/2020 12:56	12/12/2020 14:36	13/12/2020 12:38	22,04	5	110,19	CHI
20201268460	OURO VERDE DE GOIAS	OV12014230	INHUMAS S1	12/12/2020 14:36	13/12/2020 12:56	12/12/2020 14:36	13/12/2020 12:56	22,33	31	692,36	CHI
20201267007	VALPARAISO DE GOIAS	2860235626	PACAEMBU S2	12/12/2020 14:37	12/12/2020 22:50	12/12/2020 14:37	12/12/2020 22:50	8,22	1	8,22	CHI
20201267010	CRISTALINA	10002654880	CRISTALINA S1	12/12/2020 14:37	12/12/2020 16:36	12/12/2020 14:37	12/12/2020 16:36	1,98	1	1,98	CHI
20201267013	ARAGARCAS	10024481023	ARAGARCAS	12/12/2020 14:37	12/12/2020 20:53	12/12/2020 14:37	12/12/2020 20:53	6,25	1	6,25	CHI
20201267817	SAO MIGUEL DO ARAGUAIA	SM12143671	SAO MIGUEL DO ARAGUAIA	12/12/2020 14:40	12/12/2020 21:54	12/12/2020 14:40	12/12/2020 21:54	7,22	276	1992,80	CHI
20201267041	POSSE	PS12344418	IACIARA S1	12/12/2020 14:41	12/12/2020 18:40	12/12/2020 14:41	12/12/2020 18:40	3,97	41	162,86	CHI
20201267042	PILAR DE GOIAS	NH12166555	SANTA TEREZINHA	12/12/2020 14:41	14/12/2020 01:16	12/12/2020 14:41	14/12/2020 01:16	34,57	2	69,14	CHI
20201267042	NOVA IGUACU DE GOIAS	NH12166555	SANTA TEREZINHA	12/12/2020 14:41	14/12/2020 01:16	12/12/2020 14:41	14/12/2020 01:16	34,57	2	69,14	CHI
20201267044	CATALAO	CT21380764	CATALAO S1	12/12/2020 14:42	12/12/2020 17:27	12/12/2020 14:42	12/12/2020 17:27	2,75	1	2,75	CHI
20201267282	LUZIANIA	LZ12304992	VIANOPOLIS	12/12/2020 14:42	12/12/2020 19:14	12/12/2020 14:42	12/12/2020 19:14	4,53	70	317,27	CHI
20201268294	ORIZONA	OZ12036989	PIRES DO RIO S2	12/12/2020 14:42	12/12/2020 20:25	12/12/2020 14:42	12/12/2020 20:25	5,71	14	79,97	CHI
20201267049	APARECIDA DE GOIANIA	15460253	REAL S1	12/12/2020 14:43	12/12/2020 16:49	12/12/2020 14:43	12/12/2020 16:49	2,09	1	2,09	CHI
20201267050	CATURAI	CK21018946	INHUMAS S1	12/12/2020 14:43	12/12/2020 16:02	12/12/2020 14:43	12/12/2020 16:02	1,31	1	1,31	CHI

20201267051	PALMEIRAS DE GOIAS	PL12098934	PALMEIRAS	12/12/2020 14:43	13/12/2020 16:23	12/12/2020 14:43	13/12/2020 16:23	25,65	2	51,30	CHI
20201267589	CAMPESTRE DE GOIAS	GC12000278	TRINDADE	12/12/2020 14:43	12/12/2020 17:58	12/12/2020 14:43	12/12/2020 17:58	3,25	9	29,24	CHI
20201268674	MARA ROSA	MQ12390465	MARA ROSA	12/12/2020 14:44	12/12/2020 20:30	12/12/2020 14:44	12/12/2020 20:30	5,76	85	489,65	CHI
20201268674	AMARALINA	MQ12390465	MARA ROSA	12/12/2020 14:44	12/12/2020 20:30	12/12/2020 14:44	12/12/2020 20:30	5,76	282	1624,48	CHI
20201267058	PIRACANJUBA	PJ12223407	ROCHEDO	12/12/2020 14:45	13/12/2020 04:32	12/12/2020 14:45	13/12/2020 04:32	13,77	2	27,54	CHI
20201267059	JOVIANIA	JV12208105	VICENTINOPOLIS	12/12/2020 14:46	12/12/2020 18:50	12/12/2020 14:46	12/12/2020 18:50	4,07	5	20,33	CHI
20201267063	TROMBAS	2560013107	PORANGATU	12/12/2020 14:46	12/12/2020 18:41	12/12/2020 14:46	12/12/2020 18:41	3,91	1	3,91	CHI
20201267207	ORIZONA	OZ12114492	PIRES DO RIO S2	12/12/2020 14:46	12/12/2020 17:39	12/12/2020 14:46	12/12/2020 17:39	2,87	8	22,99	CHI
20201267072	FORMOSA	10005686162	ITIQUEIRA	12/12/2020 14:47	12/12/2020 21:39	12/12/2020 14:47	12/12/2020 21:39	6,86	1	6,86	CHI
20201267073	BARRO ALTO	BA21342222	GOIANESIA S1	12/12/2020 14:47	13/12/2020 01:12	12/12/2020 14:47	13/12/2020 01:12	10,41	1	10,41	CHI
20201267217	ALTO HORIZONTE	AJ12320992RE	SANTA TEREZINHA	12/12/2020 14:47	13/12/2020 20:18	12/12/2020 14:47	13/12/2020 15:50	25,05	36	901,93	CHI
20201267217	ALTO HORIZONTE	AJ12320992RE	SANTA TEREZINHA	12/12/2020 14:47	13/12/2020 20:18	12/12/2020 14:47	13/12/2020 20:18	29,51	11	324,66	CHI
20201267774	VIANOPOLIS	VN12068361	VIANOPOLIS	12/12/2020 14:48	12/12/2020 19:02	12/12/2020 14:48	12/12/2020 19:02	4,22	26	109,71	CHI
20201267151	MARA ROSA	LC12244523	MARA ROSA	12/12/2020 14:49	12/12/2020 22:15	12/12/2020 14:49	12/12/2020 22:15	7,42	3	22,26	CHI
20201267151	AMARALINA	LC12244523	MARA ROSA	12/12/2020 14:49	12/12/2020 22:15	12/12/2020 14:49	12/12/2020 22:15	7,42	3	22,26	CHI
20201267355	SANTA TEREZINHA DE GOIAS	GG12171805RE	SANTA TEREZINHA	12/12/2020 14:49	12/12/2020 17:04	12/12/2020 14:49	12/12/2020 17:04	2,24	47	105,25	CHI
20201267355	PILAR DE GOIAS	GG12171805RE	SANTA TEREZINHA	12/12/2020 14:49	12/12/2020 17:04	12/12/2020 14:49	12/12/2020 17:04	2,24	60	134,37	CHI
20201267225	CATALAO	CT12358318	CATALAO S2	12/12/2020 14:50	12/12/2020 17:20	12/12/2020 14:50	12/12/2020 17:20	2,49	7	17,42	CHI
20201267235	ITARUMA	IM12296701	CACHOEIRA ALTA	12/12/2020 14:50	13/12/2020 08:46	12/12/2020 14:50	13/12/2020 08:46	17,92	3	53,77	CHI
20201267099	ARAGOIANA	AO31059863	GUAPO S2	12/12/2020 14:52	12/12/2020 19:30	12/12/2020 14:52	12/12/2020 19:30	4,63	1	4,63	CHI
20201267169	BARRO ALTO	BA12328283	BARRO ALTO	12/12/2020 14:53	13/12/2020 20:37	12/12/2020 14:53	13/12/2020 20:37	29,72	5	148,61	CHI
20201267181	VIANOPOLIS	SQ12231379	CRISTIANOPOLIS	12/12/2020 14:53	14/12/2020 17:50	12/12/2020 14:53	12/12/2020 18:30	3,61	4	14,44	CHI
20201267181	SAO MIGUEL DO PASSA QUATRO	SQ12231379	CRISTIANOPOLIS	12/12/2020 14:53	14/12/2020 17:50	12/12/2020 14:53	12/12/2020 20:18	5,41	14	75,76	CHI
20201267181	VIANOPOLIS	SQ12231379	CRISTIANOPOLIS	12/12/2020 14:53	14/12/2020 17:50	12/12/2020 14:53	12/12/2020 20:18	5,41	1	5,41	CHI
20201267181	VIANOPOLIS	SQ12231379	CRISTIANOPOLIS	12/12/2020 14:53	14/12/2020 17:50	12/12/2020 14:53	14/12/2020 17:50	50,95	2	101,90	CHI
20201267113	CACHOEIRA ALTA	CA21226908	CACHOEIRA ALTA	12/12/2020 14:54	12/12/2020 16:14	12/12/2020 14:54	12/12/2020 16:14	1,32	2	2,65	CHI
20201267524	SANTO ANTONIO DO DESCOBERTO	SN11131982	MARAJOARA	12/12/2020 14:54	12/12/2020 18:50	12/12/2020 14:54	12/12/2020 18:50	3,93	53	208,41	CHI
20201267122	VALPARAISO DE GOIAS	VA11169023	PACAEMBU S2	12/12/2020 14:56	12/12/2020 22:30	12/12/2020 14:56	12/12/2020 22:30	7,56	92	695,88	CHI
20201267124	CAMPINACU	UC12197189	PORANGATU	12/12/2020 14:56	13/12/2020 10:47	12/12/2020 14:56	13/12/2020 10:47	19,84	67	1329,00	CHI
20201267370	ITAUCU	IX12000011	INHUMAS S1	12/12/2020 14:56	12/12/2020 16:32	12/12/2020 14:56	12/12/2020 16:32	1,59	368	586,86	CHI
20201267194	SANTA TEREZINHA DE GOIAS	SG12156648	SANTA TEREZINHA	12/12/2020 14:57	12/12/2020 18:56	12/12/2020 14:57	12/12/2020 18:56	3,98	2	7,96	CHI
20201267128	URUACU	UR21135511	CAMPINORTE	12/12/2020 14:58	12/12/2020 17:05	12/12/2020 14:58	12/12/2020 17:05	2,11	1	2,11	CHI
20201267133	PARAUNA	PU12295854	ACREUNA	12/12/2020 14:58	12/12/2020 17:28	12/12/2020 14:58	12/12/2020 17:28	2,48	2	4,97	CHI
20201267134	CAMPO LIMPO	AN21077962	NEROPOLIS S1	12/12/2020 14:58	12/12/2020 18:58	12/12/2020 14:58	12/12/2020 18:58	3,98	2	7,97	CHI
20201267136	JATAI	290061763	JATAI S2	12/12/2020 14:59	12/12/2020 16:01	12/12/2020 14:59	12/12/2020 16:01	1,03	1	1,03	CHI
20201267140	HIDROLINA	HL12136482RE	ITAPACI	12/12/2020 14:59	13/12/2020 00:56	12/12/2020 14:59	13/12/2020 00:56	9,94	50	496,83	CHI
20201267142	JATAI	10024366445	JATAI S2	12/12/2020 15:00	12/12/2020 17:41	12/12/2020 15:00	12/12/2020 17:41	2,67	1	2,67	CHI
20201267144	ALEXANIA	AX21318552	ALEXANIA	12/12/2020 15:01	12/12/2020 23:41	12/12/2020 15:01	12/12/2020 23:41	8,66	1	8,66	CHI
20201267146	ARAGUAPAZ	AZ21188013	GOIAS	12/12/2020 15:02	12/12/2020 16:04	12/12/2020 15:02	12/12/2020 16:04	1,03	1	1,03	CHI
20201268200	BONOPOLIS	BX12079321RE	SAO MIGUEL DO ARAGUAIA	12/12/2020 15:02	13/12/2020 07:15	12/12/2020 15:02	13/12/2020 07:15	16,21	59	956,64	CHI
20201267406	SAO MIGUEL DO PASSA QUATRO	SQ12112026	CRISTIANOPOLIS	12/12/2020 15:03	13/12/2020 02:43	12/12/2020 15:03	13/12/2020 02:43	11,66	18	209,80	CHI
20201267185	CAMPOS VERDES	VD12181194	SANTA TEREZINHA	12/12/2020 15:04	12/12/2020 19:13	12/12/2020 15:04	12/12/2020 19:13	4,15	13	53,92	CHI
20201267167	PILAR DE GOIAS	HL12293455	URUACU	12/12/2020 15:05	12/12/2020 16:56	12/12/2020 15:05	12/12/2020 16:56	1,84	1	1,84	CHI
20201267167	HIDROLINA	HL12293455	URUACU	12/12/2020 15:05	12/12/2020 16:56	12/12/2020 15:05	12/12/2020 16:56	1,84	2	3,69	CHI
20201267170	PADRE BERNARDO	PB12305105	PADRE BERNARDO	12/12/2020 15:05	12/12/2020 17:38	12/12/2020 15:05	12/12/2020 17:38	2,54	19	48,31	CHI
20201267564	ALEXANIA	AX12071331	ALEXANIA	12/12/2020 15:05	12/12/2020 20:13	12/12/2020 15:05	12/12/2020 20:13	5,13	10	51,33	CHI
20201267564	SANTO ANTONIO DO DESCOBERTO	AX12071331	ALEXANIA	12/12/2020 15:05	12/12/2020 20:13	12/12/2020 15:05	12/12/2020 20:13	5,13	2	10,27	CHI
20201267173	SAO LUIS DE MONTES BELOS	SL21361548	FIRMINOPOLIS S1	12/12/2020 15:06	12/12/2020 22:12	12/12/2020 15:06	12/12/2020 22:12	7,09	2	14,19	CHI
20201267175	ALVORADA DO NORTE	10012350158	IACIARA S2	12/12/2020 15:06	12/12/2020 18:22	12/12/2020 15:06	12/12/2020 18:22	3,26	1	3,26	CHI
20201267180	CALDAZINHA	SW12217284	CEPAIGO S2	12/12/2020 15:06	12/12/2020 16:43	12/12/2020 15:06	12/12/2020 16:43	1,60	6	9,60	CHI
20201267180	LEOPOLDO DE BULHOES	SW12217284	CEPAIGO S2	12/12/2020 15:06	12/12/2020 16:43	12/12/2020 15:06	12/12/2020 16:43	1,60	55	88,02	CHI

20201267821	FORMOSA	FA12357434	SAO JOAO D ALIANCA	12/12/2020 15:07	12/12/2020 22:12	12/12/2020 15:07	12/12/2020 22:12	7,08	4	28,32	CHI
20201267196	IACIARA	IA21090934	IACIARA S2	12/12/2020 15:10	12/12/2020 18:17	12/12/2020 15:10	12/12/2020 18:17	3,11	1	3,11	CHI
20201267428	ITAPIRAPUA	IU12014848	MATRINCHA	12/12/2020 15:10	12/12/2020 18:00	12/12/2020 15:10	12/12/2020 18:00	2,82	57	160,84	CHI
20201267356	CALDAZINHA	BV12000063	CEPAIGO S2	12/12/2020 15:11	12/12/2020 17:10	12/12/2020 15:11	12/12/2020 17:10	1,98	126	248,92	CHI
20201267577	NIQUELANDIA	NQ12208518	NIQUELANDIA SUBTRANSMISSAO	12/12/2020 15:11	13/12/2020 01:33	12/12/2020 15:11	13/12/2020 01:33	10,36	96	994,64	CHI
20201267759	NIQUELANDIA	NQ12262921	BARRO ALTO	12/12/2020 15:11	13/12/2020 09:38	12/12/2020 15:11	13/12/2020 09:38	18,45	6	110,68	CHI
20201267211	OUVIDOR	OU12083833RE	CATALAO S1	12/12/2020 15:12	13/12/2020 00:30	12/12/2020 15:12	13/12/2020 00:30	9,30	41	381,17	CHI
20201267346	ARENOPOLIS	DI12212977	ARENOPOLIS	12/12/2020 15:12	12/12/2020 17:46	12/12/2020 15:12	12/12/2020 17:46	2,56	1	2,56	CHI
20201267346	IPORA	DI12212977	ARENOPOLIS	12/12/2020 15:12	12/12/2020 17:46	12/12/2020 15:12	12/12/2020 17:46	2,56	7	17,91	CHI
20201267981	FLORES DE GOIAS	FB12204157	FLORES DE GOIAS	12/12/2020 15:12	13/12/2020 09:25	12/12/2020 15:12	13/12/2020 09:25	18,20	13	236,66	CHI
20201267220	LUZIANIA	10006194514	MARAJOARA	12/12/2020 15:13	12/12/2020 19:52	12/12/2020 15:13	12/12/2020 19:52	4,64	1	4,64	CHI
20201267257	ALEXANIA	AX12384864	ALEXANIA	12/12/2020 15:13	12/12/2020 17:38	12/12/2020 15:13	12/12/2020 17:38	2,41	79	190,32	CHI
20201267226	EDEALINA	CZ32013590	PONTALINA	12/12/2020 15:15	12/12/2020 18:06	12/12/2020 15:15	12/12/2020 18:06	2,85	21	59,84	CHI
20201267226	CEZARINA	CZ32013590	PONTALINA	12/12/2020 15:15	12/12/2020 18:06	12/12/2020 15:15	12/12/2020 18:06	2,85	2	5,70	CHI
20201267231	RIO QUENTE	RQ21063412	RIO QUENTE	12/12/2020 15:15	12/12/2020 17:50	12/12/2020 15:15	12/12/2020 17:50	2,58	1	2,58	CHI
20201267232	FORMOSA	FA21120086	ITUIQUIRA	12/12/2020 15:15	12/12/2020 17:16	12/12/2020 15:15	12/12/2020 17:16	2,02	1	2,02	CHI
20201267239	QUIRINOPOLIS	QI12296553	QUIRINOPOLIS	12/12/2020 15:16	12/12/2020 22:14	12/12/2020 15:16	12/12/2020 22:14	6,96	1	6,96	CHI
20201267243	LUZIANIA	LZ21097157	VIANOPOLIS	12/12/2020 15:16	12/12/2020 21:48	12/12/2020 15:16	12/12/2020 21:48	6,52	2	13,04	CHI
20201267265	SAO LUIZ DO NORTE	SZ10410838	ITAPACI	12/12/2020 15:17	14/12/2020 16:39	12/12/2020 15:17	12/12/2020 16:52	1,57	123	193,18	CHI
20201267265	SAO LUIZ DO NORTE	SZ10410838	ITAPACI	12/12/2020 15:17	14/12/2020 16:39	12/12/2020 15:17	12/12/2020 19:16	3,97	31	122,99	CHI
20201267265	SANTA ISABEL	SZ10410838	ITAPACI	12/12/2020 15:17	14/12/2020 16:39	12/12/2020 15:17	12/12/2020 19:16	3,97	4	15,87	CHI
20201267265	GOIANESIA	SZ10410838	ITAPACI	12/12/2020 15:17	14/12/2020 16:39	12/12/2020 15:17	12/12/2020 19:16	3,97	9	35,71	CHI
20201267265	GOIANESIA	SZ10410838	ITAPACI	12/12/2020 15:17	14/12/2020 16:39	12/12/2020 15:17	12/12/2020 19:25	4,12	3	12,37	CHI
20201267265	SANTA ISABEL	SZ10410838	ITAPACI	12/12/2020 15:17	14/12/2020 16:39	12/12/2020 15:17	12/12/2020 19:25	4,12	1	4,12	CHI
20201267265	SAO LUIZ DO NORTE	SZ10410838	ITAPACI	12/12/2020 15:17	14/12/2020 16:39	12/12/2020 19:17	12/12/2020 19:32	0,24	123	29,73	CHI
20201267265	SANTA ISABEL	SZ13201740	ITAPACI	12/12/2020 15:17	14/12/2020 16:39	12/12/2020 19:17	12/12/2020 20:55	1,63	1	1,63	CHI
20201267265	GOIANESIA	SZ13201740	ITAPACI	12/12/2020 15:17	14/12/2020 16:39	12/12/2020 19:17	12/12/2020 20:55	1,63	3	4,90	CHI
20201267265	SAO LUIZ DO NORTE	SZ13201740	ITAPACI	12/12/2020 15:17	14/12/2020 16:39	12/12/2020 19:17	12/12/2020 20:55	1,63	31	50,67	CHI
20201267265	SANTA ISABEL	GE12101186LD	ITAPACI	12/12/2020 15:17	14/12/2020 16:39	12/12/2020 19:17	12/12/2020 22:29	3,20	3	9,61	CHI
20201267265	GOIANESIA	GE12101186LD	ITAPACI	12/12/2020 15:17	14/12/2020 16:39	12/12/2020 19:17	12/12/2020 22:29	3,20	5	16,01	CHI
20201267265	GOIANESIA	04640414	ITAPACI	12/12/2020 15:17	14/12/2020 16:39	13/12/2020 09:52	13/12/2020 10:10	0,30	3	0,91	CHI
20201267265	SANTA ISABEL	04640414	ITAPACI	12/12/2020 15:17	14/12/2020 16:39	13/12/2020 09:52	13/12/2020 10:10	0,30	1	0,30	CHI
20201267265	SAO LUIZ DO NORTE	SZ10410838	ITAPACI	12/12/2020 15:17	14/12/2020 16:39	13/12/2020 19:55	13/12/2020 20:11	0,27	154	42,01	CHI
20201267265	GOIANESIA	SZ10410838	ITAPACI	12/12/2020 15:17	14/12/2020 16:39	13/12/2020 19:55	13/12/2020 20:11	0,27	8	2,18	CHI
20201267265	SANTA ISABEL	SZ10410838	ITAPACI	12/12/2020 15:17	14/12/2020 16:39	13/12/2020 19:55	13/12/2020 20:11	0,27	4	1,09	CHI
20201267265	GOIANESIA	GE12280193LD	ITAPACI	12/12/2020 15:17	14/12/2020 16:39	12/12/2020 19:17	14/12/2020 16:02	44,75	1	44,75	CHI
20201267265	SANTA ISABEL	GE13101189	ITAPACI	12/12/2020 15:17	14/12/2020 16:39	14/12/2020 16:29	14/12/2020 16:39	0,17	1	0,17	CHI
20201267265	GOIANESIA	GE13101189	ITAPACI	12/12/2020 15:17	14/12/2020 16:39	14/12/2020 16:29	14/12/2020 16:39	0,17	4	0,68	CHI
20201269403	JARAGUA	JA12278876	JARAGUA	12/12/2020 15:17	12/12/2020 23:33	12/12/2020 15:17	12/12/2020 23:33	8,26	3	24,78	CHI
20201267255	JARAGUA	70124012	JARAGUA	12/12/2020 15:18	12/12/2020 18:23	12/12/2020 15:18	12/12/2020 18:23	3,09	1	3,09	CHI
20201267272	SAO MIGUEL DO PASSA QUATRO	BV12272141	BELA VISTA S2	12/12/2020 15:20	12/12/2020 23:37	12/12/2020 15:20	12/12/2020 23:37	8,27	91	752,37	CHI
20201267272	BELA VISTA DE GOIAS	BV12272141	BELA VISTA S2	12/12/2020 15:20	12/12/2020 23:37	12/12/2020 15:20	12/12/2020 23:37	8,27	33	272,84	CHI
20201267537	PETROLINA DE GOIAS	PG21255396	PETROLINA	12/12/2020 15:21	12/12/2020 17:56	12/12/2020 15:21	12/12/2020 17:56	2,58	1	2,58	CHI
20201267628	NOVO BRASIL	IU12061602	JUSSARA	12/12/2020 15:21	13/12/2020 08:05	12/12/2020 15:21	13/12/2020 08:05	16,72	15	250,84	CHI
20201267628	ITAPIRAPUA	IU12061602	JUSSARA	12/12/2020 15:21	13/12/2020 08:05	12/12/2020 15:21	13/12/2020 08:05	16,72	1	16,72	CHI
20201267283	SAO JOAO D ALIANCA	JL21312404	FLORES DE GOIAS	12/12/2020 15:22	13/12/2020 14:00	12/12/2020 15:22	13/12/2020 14:00	22,62	1	22,62	CHI
20201267288	LUZIANIA	LZ11370783	MARAJOARA	12/12/2020 15:23	12/12/2020 21:18	12/12/2020 15:23	12/12/2020 21:18	5,90	2	11,81	CHI
20201267366	BARRO ALTO	PV12069121	GOIANESIA S1	12/12/2020 15:23	13/12/2020 13:25	12/12/2020 15:23	13/12/2020 13:25	22,02	1	22,02	CHI
20201267366	VILA PROPICIO	PV12069121	GOIANESIA S1	12/12/2020 15:23	13/12/2020 13:25	12/12/2020 15:23	13/12/2020 13:25	22,02	4	88,08	CHI
20201268072	SILVANIA	SV12317632	VIANOPOLIS	12/12/2020 15:23	13/12/2020 22:19	12/12/2020 15:23	13/12/2020 22:19	30,92	15	463,85	CHI
20201268072	VIANOPOLIS	SV12317632	VIANOPOLIS	12/12/2020 15:23	13/12/2020 22:19	12/12/2020 15:23	13/12/2020 22:19	30,92	1	30,92	CHI

20201267290	VILA PROPICIO	NP11232071	GOIANESIA S1	12/12/2020 15:24	13/12/2020 15:35	12/12/2020 15:24	13/12/2020 15:35	24,19	1	24,19	CHI
20201267292	SAO JOAO DA PARAUNA	RP21102393	PARAUNA	12/12/2020 15:24	12/12/2020 20:56	12/12/2020 15:24	12/12/2020 20:56	5,53	2	11,05	CHI
20201267293	PLANALTINA	PB10400753	PADRE BERNARDO	12/12/2020 15:24	12/12/2020 18:40	12/12/2020 15:24	12/12/2020 18:40	3,26	11	35,83	CHI
20201267293	PADRE BERNARDO	PB10400753	PADRE BERNARDO	12/12/2020 15:24	12/12/2020 18:40	12/12/2020 15:24	12/12/2020 18:40	3,26	111	361,55	CHI
20201267852	BELA VISTA DE GOIAS	BV12000046	CEPAIGO S2	12/12/2020 15:24	12/12/2020 20:19	12/12/2020 15:24	12/12/2020 20:19	4,92	31	152,40	CHI
20201267306	MAURILANDIA	ML11072174	RIO DOS BOIS	12/12/2020 15:25	12/12/2020 23:54	12/12/2020 15:25	12/12/2020 23:54	8,49	127	1077,70	CHI
20201267314	PADRE BERNARDO	PB12363227	PADRE BERNARDO	12/12/2020 15:26	12/12/2020 20:07	12/12/2020 15:26	12/12/2020 20:07	4,67	9	42,01	CHI
20201267373	HIDROLINA	HL12068284RE	URUACU	12/12/2020 15:26	12/12/2020 18:37	12/12/2020 15:26	12/12/2020 18:37	3,17	22	69,78	CHI
20201267388	PIRES DO RIO	OZ12372381	PIRES DO RIO S2	12/12/2020 15:30	12/12/2020 19:35	12/12/2020 15:30	12/12/2020 19:35	4,08	9	36,75	CHI
20201267388	VIANOPOLIS	OZ12372381	PIRES DO RIO S2	12/12/2020 15:30	12/12/2020 19:35	12/12/2020 15:30	12/12/2020 19:35	4,08	19	77,58	CHI
20201267862	MUNDO NOVO DE GOIAS	MH12208600	NOVA CRIXAS	12/12/2020 15:32	13/12/2020 10:01	12/12/2020 15:32	13/12/2020 10:01	18,48	3	55,43	CHI
20201267862	UIRAPURU	MH12208600	NOVA CRIXAS	12/12/2020 15:32	13/12/2020 10:01	12/12/2020 15:32	13/12/2020 10:01	18,48	15	277,13	CHI
20201267351	APORE	3110004481	ITAJA S1	12/12/2020 15:33	12/12/2020 20:18	12/12/2020 15:33	12/12/2020 20:18	4,74	1	4,74	CHI
20201267352	RIO VERDE	630248126	RIO VERDE S2	12/12/2020 15:33	12/12/2020 20:12	12/12/2020 15:33	12/12/2020 20:12	4,65	1	4,65	CHI
20201268036	IACIARA	IA12262204	IACIARA S2	12/12/2020 15:33	12/12/2020 18:53	12/12/2020 15:33	12/12/2020 18:53	3,32	10	33,23	CHI
20201267358	MIMOSO DE GOIAS	MJ12377231	PADRE BERNARDO	12/12/2020 15:34	12/12/2020 20:28	12/12/2020 15:34	12/12/2020 20:28	4,89	45	219,89	CHI
20201267360	LUZIANIA	SV12350759LD	VIANOPOLIS	12/12/2020 15:35	13/12/2020 12:12	12/12/2020 15:35	12/12/2020 23:54	8,32	16	133,09	CHI
20201267360	LUZIANIA	SV12350759LD	VIANOPOLIS	12/12/2020 15:35	13/12/2020 12:12	12/12/2020 18:47	12/12/2020 23:54	5,11	80	408,89	CHI
20201267360	LUZIANIA	LZ13433827B	VIANOPOLIS	12/12/2020 15:35	13/12/2020 12:12	12/12/2020 15:35	13/12/2020 08:24	16,82	151	2539,36	CHI
20201267360	LUZIANIA	LZ12086797	VIANOPOLIS	12/12/2020 15:35	13/12/2020 12:12	12/12/2020 15:35	13/12/2020 11:43	20,13	28	563,73	CHI
20201267360	LUZIANIA	LZ12261608	VIANOPOLIS	12/12/2020 15:35	13/12/2020 12:12	12/12/2020 15:35	13/12/2020 12:12	20,63	71	1464,47	CHI
20201267362	PIRACANJUBA	PJ21286299	PIRACANJUBA	12/12/2020 15:35	13/12/2020 09:59	12/12/2020 15:35	13/12/2020 09:59	18,40	1	18,40	CHI
20201267372	MONTE ALEGRE DE GOIAS	MA12212608	SAO DOMINGOS	12/12/2020 15:36	12/12/2020 18:01	12/12/2020 15:36	12/12/2020 18:01	2,40	55	132,08	CHI
20201269362	BARRO ALTO	BA12258276	GOIANESIA S1	12/12/2020 15:37	13/12/2020 00:28	12/12/2020 15:37	13/12/2020 00:28	8,85	15	132,69	CHI
20201269362	GOIANESIA	BA12258276	GOIANESIA S1	12/12/2020 15:37	13/12/2020 00:28	12/12/2020 15:37	13/12/2020 00:28	8,85	113	999,61	CHI
20201269362	VILA PROPICIO	BA12258276	GOIANESIA S1	12/12/2020 15:37	13/12/2020 00:28	12/12/2020 15:37	13/12/2020 00:28	8,85	1	8,85	CHI
20201270561	AMARALINA	LC12286013	NOVA CRIXAS	12/12/2020 15:37	13/12/2020 15:40	12/12/2020 15:37	13/12/2020 15:40	24,03	9	216,30	CHI
20201270561	MARA ROSA	LC12286013	NOVA CRIXAS	12/12/2020 15:37	13/12/2020 15:40	12/12/2020 15:37	13/12/2020 15:40	24,03	1	24,03	CHI
20201267389	PIRACANJUBA	PJ11000008	PIRACANJUBA	12/12/2020 15:38	12/12/2020 18:54	12/12/2020 15:38	12/12/2020 18:54	3,25	98	318,94	CHI
20201267390	SAO LUIS DE MONTES BELOS	10014806710	SAO LUIZ DOS MONTES BELOS	12/12/2020 15:38	12/12/2020 19:23	12/12/2020 15:38	12/12/2020 19:23	3,74	1	3,74	CHI
20201267392	GOIANIA	10308593	CAMPINAS S2	12/12/2020 15:39	12/12/2020 21:29	12/12/2020 15:39	12/12/2020 21:29	5,83	1	5,83	CHI
20201267414	ALTO HORIZONTE	AJ21317688	SANTA TEREZINHA	12/12/2020 15:42	13/12/2020 21:31	12/12/2020 15:42	13/12/2020 21:31	29,82	1	29,82	CHI
20201267418	POSSE	PS12375542	IACIARA S2	12/12/2020 15:42	12/12/2020 19:00	12/12/2020 15:42	12/12/2020 19:00	3,29	4	13,15	CHI
20201267419	GOIANIA	13055781	GOYA S2	12/12/2020 15:42	12/12/2020 22:26	12/12/2020 15:42	12/12/2020 22:26	6,72	1	6,72	CHI
20201267426	FORMOSA	FA32042715	SAO JOAO D ALIANCA	12/12/2020 15:43	12/12/2020 19:33	12/12/2020 15:43	12/12/2020 19:33	3,83	95	363,61	CHI
20201267437	CATALAO	CT12272542LD	CATALAO S1	12/12/2020 15:44	12/12/2020 21:41	12/12/2020 15:44	12/12/2020 21:41	5,95	1	5,95	CHI
20201267740	LEOPOLDO DE BULHOES	LB12100605	CEPAIGO S2	12/12/2020 15:44	12/12/2020 18:20	12/12/2020 15:44	12/12/2020 18:20	2,59	9	23,35	CHI
20201267740	BONFINOPOLIS	LB12100605	CEPAIGO S2	12/12/2020 15:44	12/12/2020 18:20	12/12/2020 15:44	12/12/2020 18:20	2,59	20	51,89	CHI
20201267927	CATALAO	CT12061234	CATALAO S1	12/12/2020 15:44	12/12/2020 18:31	12/12/2020 15:44	12/12/2020 18:31	2,77	17	47,15	CHI
20201268590	LUZIANIA	LZ12390037	MARAJOARA	12/12/2020 15:44	12/12/2020 21:18	12/12/2020 15:44	12/12/2020 21:18	5,57	83	461,94	CHI
20201267513	NOVA ROMA	ND12392238	IACIARA S2	12/12/2020 15:45	12/12/2020 17:25	12/12/2020 15:45	12/12/2020 17:25	1,66	235	391,14	CHI
20201267562	SAO LUIZ DO NORTE	GE12352313	GOIANESIA S1	12/12/2020 15:45	13/12/2020 15:49	12/12/2020 15:45	13/12/2020 15:49	24,07	21	505,38	CHI
20201267562	GOIANESIA	GE12352313	GOIANESIA S1	12/12/2020 15:45	13/12/2020 15:49	12/12/2020 15:45	13/12/2020 15:49	24,07	24	577,58	CHI
20201267485	PIRES DO RIO	01480414	PIRES DO RIO S2	12/12/2020 15:47	12/12/2020 17:16	12/12/2020 15:50	12/12/2020 16:45	0,92	3	2,77	CHI
20201267485	IPAMERI	PR13344683	PIRES DO RIO S2	12/12/2020 15:47	12/12/2020 17:16	12/12/2020 15:50	12/12/2020 17:16	1,44	25	35,98	CHI
20201267485	URUTAI	PR13344683	PIRES DO RIO S2	12/12/2020 15:47	12/12/2020 17:16	12/12/2020 15:50	12/12/2020 17:16	1,44	104	149,67	CHI
20201267485	PIRES DO RIO	PR13344683	PIRES DO RIO S2	12/12/2020 15:47	12/12/2020 17:16	12/12/2020 15:50	12/12/2020 17:16	1,44	7	10,07	CHI
20201267485	ORIZONA	PR13344683	PIRES DO RIO S2	12/12/2020 15:47	12/12/2020 17:16	12/12/2020 15:50	12/12/2020 17:16	1,44	9	12,95	CHI
20201267485	IPAMERI	PR13344683	PIRES DO RIO S2	12/12/2020 15:47	12/12/2020 17:16	12/12/2020 16:41	12/12/2020 17:16	0,59	2	1,18	CHI
20201267468	NIQUELANDIA	NQ21283438	NIQUELANDIA SUBTRANSMISSAO	12/12/2020 15:49	13/12/2020 10:42	12/12/2020 15:49	13/12/2020 10:42	18,88	1	18,88	CHI
20201267471	MUNDO NOVO DE GOIAS	MH11037811	NOVA CRIXAS	12/12/2020 15:49	12/12/2020 18:00	12/12/2020 15:49	12/12/2020 18:00	2,17	82	178,05	CHI

20201267474	CRISTALINA	10006451452	PAMPLONA	12/12/2020 15:49	12/12/2020 18:57	12/12/2020 15:49	12/12/2020 18:57	3,12	1	3,12	CHI
20201267483	AURILANDIA	AI21161822	FIRMINOPOLIS S2	12/12/2020 15:51	12/12/2020 17:43	12/12/2020 15:51	12/12/2020 17:43	1,87	1	1,87	CHI
20201267490	IPORA	IR21168902	IPORA	12/12/2020 15:51	12/12/2020 19:36	12/12/2020 15:51	12/12/2020 19:36	3,75	1	3,75	CHI
20201268770	BELA VISTA DE GOIAS	BV12009000	BELA VISTA S2	12/12/2020 15:52	13/12/2020 09:17	12/12/2020 15:52	13/12/2020 09:17	17,41	56	974,82	CHI
20201269418	HIDROLINA	HL12292474	URUACU	12/12/2020 15:52	13/12/2020 03:32	12/12/2020 15:52	13/12/2020 03:32	11,66	7	81,64	CHI
20201267826	SANTA CRUZ DE GOIAS	BC12390409	PIRES DO RIO S2	12/12/2020 15:53	12/12/2020 19:45	12/12/2020 15:53	12/12/2020 19:45	3,86	8	30,88	CHI
20201267522	INDIARA	JD12340064	ACREUNA	12/12/2020 15:56	13/12/2020 16:27	12/12/2020 15:56	13/12/2020 16:27	24,52	3	73,55	CHI
20201267522	JANDAIA	JD12340064	ACREUNA	12/12/2020 15:56	13/12/2020 16:27	12/12/2020 15:56	13/12/2020 16:27	24,52	13	318,70	CHI
20201267527	ITAPACI	IW11210181	ITAPACI	12/12/2020 15:57	12/12/2020 18:33	12/12/2020 15:57	12/12/2020 18:33	2,59	60	155,35	CHI
20201267530	MUTUNOPOLIS	MU21086714	MARA ROSA	12/12/2020 15:57	12/12/2020 22:06	12/12/2020 15:57	12/12/2020 22:06	6,14	1	6,14	CHI
20201267687	APARECIDA DE GOIANIA	AP12200191	REAL S1	12/12/2020 15:57	12/12/2020 20:19	12/12/2020 15:57	12/12/2020 20:19	4,38	666	2916,16	CHI
20201267534	SANTO ANTONIO DO DESCOBERTO	SN12133153	AGUAS LINDAS DE GOIAS S2	12/12/2020 15:58	12/12/2020 17:47	12/12/2020 15:58	12/12/2020 17:47	1,81	35	63,25	CHI
20201267534	DISTRITO FEDERAL	SN12133153	AGUAS LINDAS DE GOIAS S2	12/12/2020 15:58	12/12/2020 17:47	12/12/2020 15:58	12/12/2020 17:47	1,81	1	1,81	CHI
20201267542	VICENTINOPOLIS	VI21031559	VICENTINOPOLIS	12/12/2020 15:58	12/12/2020 18:21	12/12/2020 15:58	12/12/2020 18:21	2,38	1	2,38	CHI
20201267541	ITAPURANGA	19647702	ITAPURANGA	12/12/2020 15:59	13/12/2020 10:08	12/12/2020 15:59	13/12/2020 10:08	18,15	5	90,73	CHI
20201267548	CRISTALINA	10021515245	CRISTALINA S1	12/12/2020 16:00	12/12/2020 22:07	12/12/2020 16:00	12/12/2020 22:07	6,11	1	6,11	CHI
20201267553	LUZIANIA	LZ21120152	MARAJÓARA	12/12/2020 16:01	12/12/2020 21:11	12/12/2020 16:01	12/12/2020 21:11	5,16	1	5,16	CHI
20201267554	NOVA ROMA	ND21318542	IACIARA S2	12/12/2020 16:01	12/12/2020 19:39	12/12/2020 16:01	12/12/2020 19:39	3,62	1	3,62	CHI
20201267558	GOIAS	GS21307517	GOIAS	12/12/2020 16:02	12/12/2020 21:04	12/12/2020 16:02	12/12/2020 21:04	5,03	2	10,06	CHI
20201267563	SENADOR CANEDO	SW12002667	GOIANIA LESTE S2	12/12/2020 16:03	12/12/2020 21:53	12/12/2020 16:03	12/12/2020 21:53	5,82	4	23,29	CHI
20201267573	PORANGATU	TA12255123	NOVO PLANALTO	12/12/2020 16:05	13/12/2020 03:50	12/12/2020 16:05	13/12/2020 03:50	11,74	5	58,69	CHI
20201267579	IVOLANDIA	IV21193825	IPORA	12/12/2020 16:06	12/12/2020 23:16	12/12/2020 16:06	12/12/2020 23:16	7,16	1	7,16	CHI
20201267580	GOIANIA	10815934	GOIANIA LESTE S1	12/12/2020 16:06	12/12/2020 19:03	12/12/2020 16:06	12/12/2020 19:03	2,95	1	2,95	CHI
20201267585	CATALAO	CT21156938	CATALAO S2	12/12/2020 16:06	12/12/2020 18:15	12/12/2020 16:06	12/12/2020 18:15	2,14	1	2,14	CHI
20201269095	NIQUELANDIA	NQ12182463	NIQUELANDIA SUBTRANSMISSAO	12/12/2020 16:08	13/12/2020 00:54	12/12/2020 16:08	13/12/2020 00:54	8,76	24	210,35	CHI
20201267599	CUMARI	CT21042402	CATALAO S2	12/12/2020 16:09	12/12/2020 17:15	12/12/2020 16:09	12/12/2020 17:15	1,09	2	2,19	CHI
20201267641	GOIANIA	GN16415893	AEROPORTO S1	12/12/2020 16:09	12/12/2020 17:35	12/12/2020 16:13	12/12/2020 17:35	1,37	1302	1786,27	CHI
20201267604	ANAPOLIS	10031602400	ANAPOLIS UNIVERSITARIO S2	12/12/2020 16:10	12/12/2020 19:44	12/12/2020 16:10	12/12/2020 19:44	3,56	1	3,56	CHI
20201267605	CATALAO	1990077228	CATALAO S2	12/12/2020 16:10	12/12/2020 20:07	12/12/2020 16:10	12/12/2020 20:07	3,94	1	3,94	CHI
20201267610	PORTELANDIA	PW21209829	PARQUE DAS EMAS	12/12/2020 16:11	12/12/2020 19:31	12/12/2020 16:11	12/12/2020 19:31	3,33	1	3,33	CHI
20201267612	ITAPIRAPUA	IU21072453	MATRINCHA	12/12/2020 16:11	13/12/2020 09:57	12/12/2020 16:11	13/12/2020 09:57	17,76	1	17,76	CHI
20201268033	ITAUCU	IX12018278	INHUMAS S1	12/12/2020 16:11	12/12/2020 22:11	12/12/2020 16:11	12/12/2020 22:11	6,00	75	449,81	CHI
20201267621	COLINAS DO SUL	TI21181231	MINACU	12/12/2020 16:12	13/12/2020 08:49	12/12/2020 16:12	13/12/2020 08:49	16,60	2	33,21	CHI
20201267696	SAO DOMINGOS	SD12206119LD	SAO DOMINGOS	12/12/2020 16:12	13/12/2020 01:28	12/12/2020 16:12	13/12/2020 01:28	9,28	64	593,83	CHI
20201267696	SAO DOMINGOS	SD12206119LD	SAO DOMINGOS	12/12/2020 16:12	13/12/2020 01:28	12/12/2020 23:18	13/12/2020 01:28	2,17	14	30,42	CHI
20201268037	AGUAS LINDAS DE GOIAS	LA12382901	AGUAS LINDAS DE GOIAS S1	12/12/2020 16:13	12/12/2020 18:36	12/12/2020 16:13	12/12/2020 18:36	2,38	28	66,53	CHI
20201268037	SANTO ANTONIO DO DESCOBERTO	LA12382901	AGUAS LINDAS DE GOIAS S1	12/12/2020 16:13	12/12/2020 18:36	12/12/2020 16:13	12/12/2020 18:36	2,38	1	2,38	CHI
20201268492	VILA PROPICIO	NP12339454	GOIANESIA S1	12/12/2020 16:13	13/12/2020 12:05	12/12/2020 16:13	13/12/2020 12:05	19,86	112	2224,72	CHI
20201267916	CAMPO ALEGRE DE GOIAS	CM10415031	PIRES DO RIO S2	12/12/2020 16:14	12/12/2020 16:50	12/12/2020 16:14	12/12/2020 16:50	0,59	19	11,18	CHI
20201267916	IPAMERI	CM10415031	CAMPO ALEGRE DE GOIAS	12/12/2020 16:14	12/12/2020 16:50	12/12/2020 16:14	12/12/2020 16:50	0,59	81	47,66	CHI
20201267916	CAMPO ALEGRE DE GOIAS	CM10415031	CAMPO ALEGRE DE GOIAS	12/12/2020 16:14	12/12/2020 16:50	12/12/2020 16:14	12/12/2020 16:50	0,59	82	48,24	CHI
20201267916	IPAMERI	CM10415031	PIRES DO RIO S2	12/12/2020 16:14	12/12/2020 16:50	12/12/2020 16:14	12/12/2020 16:50	0,59	213	125,32	CHI
20201267632	SAO LUIS DE MONTES BELOS	SL12026487	FIRMINOPOLIS S1	12/12/2020 16:15	12/12/2020 21:42	12/12/2020 16:15	12/12/2020 21:42	5,45	2	10,90	CHI
20201267797	LUZIANIA	LZ12085964	PACAEMBU S2	12/12/2020 16:15	12/12/2020 18:57	12/12/2020 16:15	12/12/2020 18:57	2,68	31	83,20	CHI
20201267797	NOVO GAMA	LZ12085964	PACAEMBU S2	12/12/2020 16:15	12/12/2020 18:57	12/12/2020 16:15	12/12/2020 18:57	2,68	19	50,99	CHI
20201265049	CATALAO	CT21000088	CATALAO S1	12/12/2020 16:17	12/12/2020 22:42	12/12/2020 16:17	12/12/2020 22:21	6,07	1	6,07	CHI
20201265049	CATALAO	CT12306664	CATALAO S1	12/12/2020 16:17	12/12/2020 22:42	12/12/2020 20:31	12/12/2020 22:42	2,17	15	32,59	CHI
20201265049	OUVIDOR	CT12306664	CATALAO S1	12/12/2020 16:17	12/12/2020 22:42	12/12/2020 20:31	12/12/2020 22:42	2,17	2	4,35	CHI
20201268384	FORMOSA	FB12106993	FLORES DE GOIAS	12/12/2020 16:17	13/12/2020 07:10	12/12/2020 16:17	13/12/2020 07:10	14,88	138	2053,56	CHI
20201268384	SAO JOAO D ALIANCA	FB12106993	FLORES DE GOIAS	12/12/2020 16:17	13/12/2020 07:10	12/12/2020 16:17	13/12/2020 07:10	14,88	5	74,40	CHI
20201268384	FLORES DE GOIAS	FB12106993	FLORES DE GOIAS	12/12/2020 16:17	13/12/2020 07:10	12/12/2020 16:17	13/12/2020 07:10	14,88	13	193,45	CHI

20201268384	FORMOSO	FB12106993	FLORES DE GOIAS	12/12/2020 16:17	13/12/2020 07:10	12/12/2020 16:17	13/12/2020 07:10	14,88	1	14,88	CHI
20201267649	JARAGUA	JA21194354	JARAGUA	12/12/2020 16:18	13/12/2020 01:43	12/12/2020 16:18	13/12/2020 01:43	9,41	3	28,24	CHI
20201267650	AGUAS LINDAS DE GOIAS	10012780683	AGUAS LINDAS DE GOIAS S1	12/12/2020 16:18	12/12/2020 17:14	12/12/2020 16:18	12/12/2020 17:14	0,93	1	0,93	CHI
20201267653	JARAGUA	JA21354270	JARAGUA	12/12/2020 16:18	13/12/2020 17:57	12/12/2020 16:18	13/12/2020 17:57	25,64	1	25,64	CHI
20201267655	GOIANIA	10010091090	CAMPINAS S2	12/12/2020 16:18	12/12/2020 21:13	12/12/2020 16:18	12/12/2020 21:13	4,90	1	4,90	CHI
20201267661	MONTIVIDIU DO NORTE	MX11364165	PORANGATU	12/12/2020 16:20	13/12/2020 16:50	12/12/2020 16:20	13/12/2020 16:50	24,50	1	24,50	CHI
20201267662	GOIANIA	GN11151331	GOIANIA LESTE S3	12/12/2020 16:20	12/12/2020 19:10	12/12/2020 16:20	12/12/2020 19:10	2,83	3	8,48	CHI
20201267664	APARECIDA DE GOIANIA	15615730	INDEPENDENCIA S2	12/12/2020 16:20	13/12/2020 08:40	12/12/2020 16:20	13/12/2020 08:40	16,33	1	16,33	CHI
20201268130	COCALZINHO DE GOIAS	ZN12389411	AGUAS LINDAS DE GOIAS S2	12/12/2020 16:20	12/12/2020 18:16	12/12/2020 16:20	12/12/2020 18:16	1,93	124	238,73	CHI
20201268130	PADRE BERNARDO	ZN12389411	AGUAS LINDAS DE GOIAS S2	12/12/2020 16:20	12/12/2020 18:16	12/12/2020 16:20	12/12/2020 18:16	1,93	4	7,70	CHI
20201267677	GOIANIA	10000526639	GOYA S1	12/12/2020 16:21	13/12/2020 01:55	12/12/2020 16:21	13/12/2020 01:55	9,55	1	9,55	CHI
20201267680	MATRINCHA	4380012749	MATRINCHA	12/12/2020 16:22	12/12/2020 17:56	12/12/2020 16:22	12/12/2020 17:56	1,56	1	1,56	CHI
20201267681	CRIXAS	CX11360202	RUBIATABA	12/12/2020 16:22	13/12/2020 09:52	12/12/2020 16:22	13/12/2020 09:52	17,50	1	17,50	CHI
20201267692	CALDAZINHA	SW12402812	CEPAIGO S2	12/12/2020 16:23	12/12/2020 17:21	12/12/2020 16:23	12/12/2020 17:21	0,96	6	5,74	CHI
20201267698	NOVA IGUACU DE GOIAS	NH12317131	CAMPINORTE	12/12/2020 16:24	13/12/2020 02:41	12/12/2020 16:24	13/12/2020 02:41	10,27	46	472,64	CHI
20201267704	GOIANIA	GN11001101	GOIANIA LESTE S3	12/12/2020 16:24	13/12/2020 00:45	12/12/2020 21:54	13/12/2020 00:45	2,84	136	385,75	CHI
20201267722	VIANOPOLIS	OZ12084921RE	PIRES DO RIO S2	12/12/2020 16:24	12/12/2020 20:19	12/12/2020 16:24	12/12/2020 20:19	3,90	17	66,36	CHI
20201267722	ORIZONA	OZ12084921RE	PIRES DO RIO S2	12/12/2020 16:24	12/12/2020 20:19	12/12/2020 16:24	12/12/2020 20:19	3,90	87	339,59	CHI
20201268253	PIRENOPOLIS	PV12302141	SAO FRANCISCO DE GOIAS	12/12/2020 16:24	12/12/2020 18:47	12/12/2020 16:24	12/12/2020 18:47	2,37	95	225,23	CHI
20201268794	PIRES DO RIO	PR12000095	PIRES DO RIO S1	12/12/2020 16:26	12/12/2020 19:24	12/12/2020 16:26	12/12/2020 19:24	2,96	4	11,85	CHI
20201267723	LUZIANIA	SV12159750	VIANOPOLIS	12/12/2020 16:27	12/12/2020 22:49	12/12/2020 16:27	12/12/2020 22:49	6,37	5	31,83	CHI
20201267727	GOIANIA	GN11047632	REAL S1	12/12/2020 16:27	13/12/2020 00:16	12/12/2020 20:20	13/12/2020 00:16	3,93	62	243,49	CHI
20201267735	FORMOSA	610186360	ITIQUEIRA	12/12/2020 16:27	12/12/2020 23:01	12/12/2020 16:27	12/12/2020 23:01	6,55	1	6,55	CHI
20201267777	FORMOSA	FA32042639	ITIQUEIRA	12/12/2020 16:27	12/12/2020 18:02	12/12/2020 16:27	12/12/2020 18:02	1,57	20	31,48	CHI
20201267812	COCALZINHO DE GOIAS	ZN12067369	AGUAS LINDAS DE GOIAS S1	12/12/2020 16:27	12/12/2020 17:29	12/12/2020 16:27	12/12/2020 17:29	1,03	24	24,76	CHI
20201268431	CATALAO	CT12250333	CATALAO S1	12/12/2020 16:27	12/12/2020 19:33	12/12/2020 16:27	12/12/2020 19:33	3,10	41	127,11	CHI
20201270217	ITAPIRAPUA	IU12018852	MATRINCHA	12/12/2020 16:27	13/12/2020 10:40	12/12/2020 16:27	13/12/2020 10:40	18,21	36	655,61	CHI
20201267745	JATAI	JT21244187	JATAI S2	12/12/2020 16:29	12/12/2020 19:35	12/12/2020 16:29	12/12/2020 19:35	3,10	1	3,10	CHI
20201267753	PONTALINA	PK12047065	PONTALINA	12/12/2020 16:29	12/12/2020 18:45	12/12/2020 16:29	12/12/2020 18:45	2,26	10	22,62	CHI
20201268471	JARAGUA	JA12297901	JARAGUA	12/12/2020 16:29	12/12/2020 22:02	12/12/2020 16:29	12/12/2020 22:02	5,54	19	105,34	CHI
20201267789	ITABERAI	00880424	ITABERAI S1	12/12/2020 16:30	12/12/2020 19:05	12/12/2020 16:30	12/12/2020 17:10	0,67	26	17,43	CHI
20201267789	HEITORAI	HE10400390	ITAPURANGA	12/12/2020 16:30	12/12/2020 19:05	12/12/2020 16:31	12/12/2020 17:56	1,42	1	1,42	CHI
20201267789	GOIAS	HE10400390	ITAPURANGA	12/12/2020 16:30	12/12/2020 19:05	12/12/2020 16:31	12/12/2020 17:56	1,42	65	92,48	CHI
20201267789	HEITORAI	HE10400390	ITAPURANGA	12/12/2020 16:30	12/12/2020 19:05	12/12/2020 16:31	12/12/2020 17:56	1,42	50	71,14	CHI
20201267789	ITABERAI	00880424	ITABERAI S1	12/12/2020 16:30	12/12/2020 19:05	12/12/2020 16:30	12/12/2020 18:32	2,04	503	1024,02	CHI
20201267789	GOIAS	00880424	ITABERAI S1	12/12/2020 16:30	12/12/2020 19:05	12/12/2020 16:30	12/12/2020 18:32	2,04	39	79,40	CHI
20201267789	HEITORAI	00880424	ITABERAI S1	12/12/2020 16:30	12/12/2020 19:05	12/12/2020 16:30	12/12/2020 18:32	2,04	2	4,07	CHI
20201267789	ITABERAI	00880424	ITABERAI S1	12/12/2020 16:30	12/12/2020 19:05	12/12/2020 16:30	12/12/2020 18:32	2,03	146	297,11	CHI
20201267789	ITABERAI	00880424	ITABERAI S1	12/12/2020 16:30	12/12/2020 19:05	12/12/2020 16:30	12/12/2020 18:32	2,03	4	8,14	CHI
20201267789	ITABERAI	00880424	ITABERAI S1	12/12/2020 16:30	12/12/2020 19:05	12/12/2020 16:30	12/12/2020 19:05	2,60	12	31,18	CHI
20201267761	ANAPOLIS	AN11214762	JUNDIAI S2	12/12/2020 16:31	13/12/2020 00:41	12/12/2020 16:31	13/12/2020 00:41	8,16	23	187,58	CHI
202012179383	AGUAS LINDAS DE GOIAS	LA11148956	AGUAS LINDAS DE GOIAS S1	12/12/2020 16:31	12/12/2020 18:01	12/12/2020 16:31	12/12/2020 18:01	1,49	21	31,26	CHI
20201268848	RIO VERDE	RV12301462	ACREUNA	12/12/2020 16:32	13/12/2020 10:37	12/12/2020 16:32	13/12/2020 09:49	17,29	3	51,87	CHI
20201268848	RIO VERDE	RV12301462	ACREUNA	12/12/2020 16:32	13/12/2020 10:37	12/12/2020 21:30	13/12/2020 09:49	12,33	12	147,94	CHI
20201268848	RIO VERDE	RV12301462	ACREUNA	12/12/2020 16:32	13/12/2020 10:37	12/12/2020 16:32	13/12/2020 10:37	18,08	1	18,08	CHI
20201268848	SANTO ANTONIO DA BARRA	RV12301462	ACREUNA	12/12/2020 16:32	13/12/2020 10:37	12/12/2020 16:32	13/12/2020 10:37	18,08	1	18,08	CHI
20201269133	VILA PROPICIO	PV12255981	GOIANESIA S1	12/12/2020 16:32	14/12/2020 12:23	12/12/2020 16:32	14/12/2020 12:23	43,84	3	131,52	CHI
20201264597	HIDROLINA	SZ12115033	BARRO ALTO	12/12/2020 16:33	13/12/2020 15:52	12/12/2020 16:33	13/12/2020 15:47	23,24	1	23,24	CHI
20201264597	SAO LUIZ DO NORTE	SZ12115033	BARRO ALTO	12/12/2020 16:33	13/12/2020 15:52	12/12/2020 16:33	13/12/2020 15:47	23,24	9	209,13	CHI
20201264597	SAO LUIZ DO NORTE	SZ12236801	BARRO ALTO	12/12/2020 16:33	13/12/2020 15:52	13/12/2020 15:39	13/12/2020 15:52	0,21	22	4,53	CHI
20201267823	GOIAS	GS12250577	GOIAS	12/12/2020 16:34	13/12/2020 12:03	12/12/2020 16:34	12/12/2020 22:55	6,36	7	44,49	CHI

20201267823	GOIAS	GS12250577	GOIAS	12/12/2020 16:34	13/12/2020 12:03	12/12/2020 22:56	13/12/2020 07:49	8,87	7	62,11	CHI
20201267823	GOIAS	GS12250577	GOIAS	12/12/2020 16:34	13/12/2020 12:03	12/12/2020 16:34	13/12/2020 12:03	19,48	2	38,96	CHI
20201267792	ALEXANIA	AX11334294	ALEXANIA	12/12/2020 16:35	12/12/2020 18:21	12/12/2020 16:35	12/12/2020 18:21	1,75	52	91,07	CHI
20201267846	CRIXAS	CX12322605	SERRA DO OURO	12/12/2020 16:35	12/12/2020 18:29	12/12/2020 16:35	12/12/2020 18:29	1,89	16	30,23	CHI
20201268999	GOIAS	GS12056682	GOIAS	12/12/2020 16:35	12/12/2020 23:05	12/12/2020 16:35	12/12/2020 23:05	6,49	7	45,41	CHI
20201267796	CABECEIRAS	CW21218424	ITUIQUIRA	12/12/2020 16:36	12/12/2020 19:19	12/12/2020 16:36	12/12/2020 19:19	2,72	1	2,72	CHI
20201267806	CALDAS NOVAS	CN12110281	CALDAS NOVAS S1	12/12/2020 16:36	12/12/2020 23:27	12/12/2020 16:36	12/12/2020 23:27	6,85	17	116,44	CHI
20201267809	FORMOSA	FA31096307	SAO JOAO D ALIANCA	12/12/2020 16:37	12/12/2020 19:42	12/12/2020 16:37	12/12/2020 19:42	3,07	2	6,14	CHI
20201267818	JATAI	JT21260420	JATAI S1	12/12/2020 16:39	12/12/2020 20:14	12/12/2020 16:39	12/12/2020 20:14	3,58	1	3,58	CHI
20201268300	CRISTALINA	KR12304869	CRISTALINA S2	12/12/2020 16:40	12/12/2020 19:29	12/12/2020 16:40	12/12/2020 19:29	2,81	16	44,96	CHI
20201267844	JUSSARA	JR12019908	JUSSARA	12/12/2020 16:41	13/12/2020 12:46	12/12/2020 16:41	13/12/2020 12:46	20,08	4	80,31	CHI
20201267847	ITAPACI	IW21238560	RUBIATABA	12/12/2020 16:41	12/12/2020 20:24	12/12/2020 16:41	12/12/2020 20:24	3,71	1	3,71	CHI
20201267848	GOIANESIA	550125255	GOIANESIA S2	12/12/2020 16:41	13/12/2020 19:39	12/12/2020 16:41	13/12/2020 19:39	26,95	1	26,95	CHI
20201267850	LUZIANIA	LZ12199601	VIANOPOLIS	12/12/2020 16:41	13/12/2020 00:09	12/12/2020 16:41	13/12/2020 00:09	7,45	8	59,63	CHI
20201267858	EDEIA	EA12043985	EDEIA	12/12/2020 16:43	12/12/2020 18:04	12/12/2020 16:43	12/12/2020 18:04	1,34	5	6,72	CHI
20201267859	SANTA TEREZINHA DE GOIAS	SG12182466	SANTA TEREZINHA	12/12/2020 16:43	13/12/2020 17:52	12/12/2020 16:43	13/12/2020 12:02	19,31	3	57,94	CHI
20201267859	SANTA TEREZINHA DE GOIAS	SG12182466	SANTA TEREZINHA	12/12/2020 16:43	13/12/2020 17:52	12/12/2020 16:43	13/12/2020 17:52	25,16	4	100,63	CHI
20201267859	SANTA TEREZINHA DE GOIAS	SG12182466	SANTA TEREZINHA	12/12/2020 16:43	13/12/2020 17:52	12/12/2020 21:15	13/12/2020 17:52	20,62	7	144,36	CHI
20201267859	SANTA TEREZINHA DE GOIAS	SG12182466	SANTA TEREZINHA	12/12/2020 16:43	13/12/2020 17:52	13/12/2020 13:58	13/12/2020 17:52	3,91	3	11,72	CHI
20201267860	CORUMBA DE GOIAS	CB21196904	CORUMBA	12/12/2020 16:43	13/12/2020 14:29	12/12/2020 16:43	13/12/2020 14:29	21,75	1	21,75	CHI
20201267863	CACHOEIRA ALTA	10032453882	CACHOEIRA ALTA	12/12/2020 16:44	12/12/2020 17:34	12/12/2020 16:44	12/12/2020 17:34	0,83	1	0,83	CHI
20201267868	COCALZINHO DE GOIAS	ZN12124947	AGUAS LINDAS DE GOIAS S2	12/12/2020 16:45	13/12/2020 03:20	12/12/2020 16:45	13/12/2020 03:20	10,58	12	126,96	CHI
20201267868	AGUAS LINDAS DE GOIAS	ZN12124947	AGUAS LINDAS DE GOIAS S2	12/12/2020 16:45	13/12/2020 03:20	12/12/2020 16:45	13/12/2020 03:20	10,58	3	31,74	CHI
20201267893	IACIARA	PS12180908	IACIARA S2	12/12/2020 16:45	12/12/2020 17:34	12/12/2020 16:45	12/12/2020 17:34	0,82	32	26,13	CHI
20201267893	POSSE	PS12180908	IACIARA S2	12/12/2020 16:45	12/12/2020 17:34	12/12/2020 16:45	12/12/2020 17:34	0,82	35	28,58	CHI
20201268146	ORIZONA	OZ12231617	PIRES DO RIO S2	12/12/2020 16:45	13/12/2020 00:49	12/12/2020 16:45	13/12/2020 00:49	8,05	24	193,24	CHI
20201267876	APARECIDA DE GOIANIA	10003212473	INDEPENDENCIA S2	12/12/2020 16:46	12/12/2020 18:45	12/12/2020 16:46	12/12/2020 18:45	1,97	1	1,97	CHI
20201274545	COLINAS DO SUL	TI12196546RE	MINACU	12/12/2020 16:47	14/12/2020 10:59	12/12/2020 16:47	14/12/2020 10:59	42,20	28	1181,60	CHI
20201267891	GOIANIA	11954050	CAMPINAS S2	12/12/2020 16:48	12/12/2020 18:58	12/12/2020 16:48	12/12/2020 18:58	2,16	1	2,16	CHI
20201267892	FORMOSA	FA12404371	ITUIQUIRA	12/12/2020 16:48	13/12/2020 18:39	12/12/2020 16:48	13/12/2020 18:39	25,85	87	2249,34	CHI
20201267892	FLORES DE GOIAS	FA12404371	ITUIQUIRA	12/12/2020 16:48	13/12/2020 18:39	12/12/2020 16:48	13/12/2020 18:39	25,85	1	25,85	CHI
20201267895	DIORAMA	DI21044994	ARENOPOLIS	12/12/2020 16:48	12/12/2020 20:19	12/12/2020 16:48	12/12/2020 20:19	3,51	1	3,51	CHI
20201267901	CRIXAS	CX12391661	SANTA TEREZINHA	12/12/2020 16:48	12/12/2020 22:35	12/12/2020 16:48	12/12/2020 22:35	5,77	32	184,62	CHI
20201267968	MORRO AGUDO DE GOIAS	MS12113246	ITAPURANGA	12/12/2020 16:48	12/12/2020 21:59	12/12/2020 16:48	12/12/2020 21:59	5,18	7	36,28	CHI
20201267968	FAINA	MS12113246	ITAPURANGA	12/12/2020 16:48	12/12/2020 21:59	12/12/2020 16:48	12/12/2020 21:59	5,18	8	41,46	CHI
20201267968	ARAGUAPAZ	MS12113246	ITAPURANGA	12/12/2020 16:48	12/12/2020 21:59	12/12/2020 16:48	12/12/2020 21:59	5,18	2	10,36	CHI
20201271401	COLINAS DO SUL	TI12170026	MINACU	12/12/2020 16:48	13/12/2020 16:23	12/12/2020 16:48	13/12/2020 16:23	23,57	7	165,01	CHI
20201267910	URUACU	UR21232425	URUACU	12/12/2020 16:50	13/12/2020 12:10	12/12/2020 16:50	13/12/2020 12:10	19,32	1	19,32	CHI
20201267944	COCALZINHO DE GOIAS	ZN12273327	AGUAS LINDAS DE GOIAS S2	12/12/2020 16:54	13/12/2020 05:48	12/12/2020 16:54	13/12/2020 00:40	7,76	3	23,29	CHI
20201267944	COCALZINHO DE GOIAS	ZN12273327	AGUAS LINDAS DE GOIAS S2	12/12/2020 16:54	13/12/2020 05:48	12/12/2020 16:54	13/12/2020 05:48	12,89	1	12,89	CHI
20201268261	ABADIANIA	AA12413713	DAIA S2	12/12/2020 16:54	12/12/2020 20:39	12/12/2020 16:54	12/12/2020 20:39	3,74	52	194,23	CHI
20201268870	FORMOSA	FA12051044	ITUIQUIRA	12/12/2020 16:54	13/12/2020 01:09	12/12/2020 16:54	13/12/2020 01:09	8,24	6	49,42	CHI
20201267945	PALMINOPOLIS	PP12205979	FIRMINOPOLIS S2	12/12/2020 16:55	12/12/2020 22:22	12/12/2020 16:55	12/12/2020 22:22	5,45	2	10,89	CHI
20201267952	IACIARA	IA11287886	IACIARA S1	12/12/2020 16:55	12/12/2020 18:56	12/12/2020 16:55	12/12/2020 18:56	2,00	96	192,03	CHI
20201267953	URUACU	UR21117992	URUACU	12/12/2020 16:56	13/12/2020 07:35	12/12/2020 16:56	13/12/2020 07:35	14,65	1	14,65	CHI
20201267956	LUZIANIA	LZ21249221	VIANOPOLIS	12/12/2020 16:56	12/12/2020 21:00	12/12/2020 16:56	12/12/2020 21:00	4,06	2	8,12	CHI
20201268732	EDEIA	EA12026650	EDEIA	12/12/2020 16:56	12/12/2020 19:54	12/12/2020 16:56	12/12/2020 19:54	2,96	8	23,67	CHI
20201267963	GOIANIA	10155107	FERROVIARIO S3	12/12/2020 16:57	12/12/2020 21:13	12/12/2020 16:57	12/12/2020 21:13	4,26	1	4,26	CHI
20201267967	LUZIANIA	LZ11253479	VIANOPOLIS	12/12/2020 16:57	12/12/2020 22:34	12/12/2020 16:57	12/12/2020 22:34	5,61	1	5,61	CHI
20201267972	COCALZINHO DE GOIAS	ZN11315371	GOIANESIA S1	12/12/2020 16:58	13/12/2020 09:45	12/12/2020 16:58	13/12/2020 09:45	16,78	1	16,78	CHI
20201268000	JATAI	290187503	JATAI S2	12/12/2020 17:00	12/12/2020 18:45	12/12/2020 17:00	12/12/2020 18:45	1,75	1	1,75	CHI

20201268001	FORMOSA	FA21120050	ITUIQUIRA	12/12/2020 17:00	12/12/2020 20:36	12/12/2020 17:00	12/12/2020 20:36	3,59	1	3,59	CHI
20201268004	VILA PROPICIO	1150017007	GOIANESIA S1	12/12/2020 17:00	13/12/2020 15:12	12/12/2020 17:00	13/12/2020 15:12	22,19	1	22,19	CHI
20201268008	CIXAS	CX12318471	SERRA DO OURO	12/12/2020 17:01	13/12/2020 09:46	12/12/2020 17:01	13/12/2020 09:46	16,75	12	200,96	CHI
20201268014	ITAPACI	10027970548	ITAPACI	12/12/2020 17:01	12/12/2020 23:39	12/12/2020 17:01	12/12/2020 23:39	6,62	1	6,62	CHI
20201268030	SAO MIGUEL DO PASSA QUATRO	SQ21070075	VIANOPOLIS	12/12/2020 17:01	12/12/2020 17:32	12/12/2020 17:01	12/12/2020 17:32	0,51	1	0,51	CHI
20201269324	NIQUELANDIA	NQ12371855RE	BARRO ALTO	12/12/2020 17:01	13/12/2020 17:58	12/12/2020 17:01	13/12/2020 17:58	24,94	171	4265,12	CHI
20201268020	ANAPOLIS	20266789	ANAPOLIS UNIVERSITARIO S2	12/12/2020 17:02	13/12/2020 12:16	12/12/2020 17:02	13/12/2020 12:16	19,25	1	19,25	CHI
20201268024	CAMPO ALEGRE DE GOIAS	CM12086086	CAMPO ALEGRE DE GOIAS	12/12/2020 17:02	13/12/2020 10:19	12/12/2020 17:02	13/12/2020 10:19	17,28	6	103,68	CHI
20201268402	CACHOEIRA ALTA	QI12126503	QUIRINOPOLIS	12/12/2020 17:03	12/12/2020 21:36	12/12/2020 17:03	12/12/2020 21:36	4,53	9	40,81	CHI
20201268402	RIO VERDE	QI12126503	QUIRINOPOLIS	12/12/2020 17:03	12/12/2020 21:36	12/12/2020 17:03	12/12/2020 21:36	4,53	6	27,21	CHI
20201268626	FORMOSO	CR12172326	MARA ROSA	12/12/2020 17:03	13/12/2020 13:49	12/12/2020 17:03	13/12/2020 13:49	20,75	3	62,26	CHI
20201268626	CAMPINORTE	CR12172326	MARA ROSA	12/12/2020 17:03	13/12/2020 13:49	12/12/2020 17:03	13/12/2020 13:49	20,75	3	62,26	CHI
20201269099	ITAPACI	IW11000007	ITAPACI	12/12/2020 17:03	12/12/2020 20:07	12/12/2020 17:03	12/12/2020 20:07	3,06	80	244,49	CHI
20201268047	GOIANIA	16769326	CARAJAS S1	12/12/2020 17:04	12/12/2020 20:42	12/12/2020 17:04	12/12/2020 20:42	3,62	1	3,62	CHI
20201268682	ITAPIRAPUA	IU12250535	JUSSARA	12/12/2020 17:05	13/12/2020 08:16	12/12/2020 17:05	13/12/2020 08:16	15,17	13	197,21	CHI
20201268682	JUSSARA	IU12250535	JUSSARA	12/12/2020 17:05	13/12/2020 08:16	12/12/2020 17:05	13/12/2020 08:16	15,17	9	136,53	CHI
20201268063	CALDAS NOVAS	CN12075111	SERRA DE CALDAS	12/12/2020 17:06	12/12/2020 18:26	12/12/2020 17:06	12/12/2020 18:26	1,32	20	26,43	CHI
20201268065	PALMEIRAS DE GOIAS	PL21010892	PALMEIRAS	12/12/2020 17:07	13/12/2020 17:24	12/12/2020 17:07	13/12/2020 17:24	24,28	3	72,84	CHI
20201268070	ALEXANIA	AX11398539	ALEXANIA	12/12/2020 17:07	13/12/2020 20:15	12/12/2020 17:07	13/12/2020 20:15	27,13	10	271,26	CHI
20201268071	NAZARIO	NZ12233489	ANICUNS	12/12/2020 17:07	13/12/2020 08:32	12/12/2020 17:07	13/12/2020 08:32	15,41	38	585,42	CHI
20201268071	PALMEIRAS DE GOIAS	NZ12233489	ANICUNS	12/12/2020 17:07	13/12/2020 08:32	12/12/2020 17:07	13/12/2020 08:32	15,41	3	46,22	CHI
20201268080	SAO LUIZ DO NORTE	SZ21083333	ITAPACI	12/12/2020 17:08	13/12/2020 10:38	12/12/2020 17:08	13/12/2020 10:38	17,49	1	17,49	CHI
20201268320	ANAPOLIS	AN12319783	ANAPOLIS UNIVERSITARIO S2	12/12/2020 17:09	12/12/2020 23:28	12/12/2020 17:09	12/12/2020 23:28	6,31	1	6,31	CHI
20201268320	PIRENOPOLIS	AN12319783	ANAPOLIS UNIVERSITARIO S2	12/12/2020 17:09	12/12/2020 23:28	12/12/2020 17:09	12/12/2020 23:28	6,31	18	113,60	CHI
20201268090	MONTE ALEGRE DE GOIAS	MA12238057	SAO DOMINGOS	12/12/2020 17:10	12/12/2020 23:21	12/12/2020 17:10	12/12/2020 23:21	6,18	31	191,61	CHI
20201268098	GOIANIA	GN11002140	GOYA S1	12/12/2020 17:10	13/12/2020 00:53	12/12/2020 17:10	13/12/2020 00:53	7,70	87	670,26	CHI
20201268326	COCALZINHO DE GOIAS	ZN12258078	COCALZINHO	12/12/2020 17:10	12/12/2020 21:18	12/12/2020 17:10	12/12/2020 21:18	4,12	57	234,98	CHI
20201268886	SANTO ANTONIO DO DESCOBERTO	SN12351057	ALEXANIA	12/12/2020 17:10	13/12/2020 09:00	12/12/2020 17:10	13/12/2020 09:00	15,82	5	79,12	CHI
20201268108	CALDAZINHA	BV21072782	CEPAIGO S2	12/12/2020 17:11	12/12/2020 22:03	12/12/2020 17:11	12/12/2020 22:03	4,85	2	9,70	CHI
20201268183	PIRES DO RIO	PR11083250	PIRES DO RIO S1	12/12/2020 17:12	12/12/2020 22:58	12/12/2020 17:12	12/12/2020 22:58	5,75	137	788,09	CHI
20201268116	PALMINOPOLIS	PP21007064	PALMEIRAS	12/12/2020 17:13	12/12/2020 23:17	12/12/2020 17:13	12/12/2020 23:17	6,05	1	6,05	CHI
20201268119	GOIANDIRA	2010011370	CATALAO S1	12/12/2020 17:14	12/12/2020 21:09	12/12/2020 17:14	12/12/2020 21:09	3,91	1	3,91	CHI
20201268123	URUACU	UR21243622	MARA ROSA	12/12/2020 17:15	13/12/2020 14:08	12/12/2020 17:15	13/12/2020 14:08	20,88	23	480,21	CHI
20201268128	EDEALINA	ED21160449	VICENTINOPOLIS	12/12/2020 17:15	12/12/2020 21:10	12/12/2020 17:15	12/12/2020 21:10	3,90	1	3,90	CHI
20201268778	LUZIANIA	LZ12383015	VIANOPOLIS	12/12/2020 17:15	12/12/2020 20:20	12/12/2020 17:15	12/12/2020 20:20	3,07	52	159,74	CHI
20201268133	COCALZINHO DE GOIAS	ZN12104981	AGUAS LINDAS DE GOIAS S2	12/12/2020 17:17	13/12/2020 11:42	12/12/2020 17:17	13/12/2020 11:42	18,42	3	55,25	CHI
20201268140	URUACU	CR12282384	MARA ROSA	12/12/2020 17:17	13/12/2020 05:01	12/12/2020 17:17	13/12/2020 05:01	11,72	5	58,62	CHI
20201268140	CAMPINORTE	CR12282384	MARA ROSA	12/12/2020 17:17	13/12/2020 05:01	12/12/2020 17:17	13/12/2020 05:01	11,72	1	11,72	CHI
20201268144	PIRES DO RIO	PR21372788	PIRES DO RIO S1	12/12/2020 17:17	12/12/2020 21:24	12/12/2020 17:17	12/12/2020 21:24	4,10	2	8,20	CHI
20201268282	HIDROLANDIA	HD12000134	CEPAIGO S2	12/12/2020 17:17	12/12/2020 18:42	12/12/2020 17:17	12/12/2020 18:42	1,41	4	5,63	CHI
20201268151	ALEXANIA	10025791131	ALEXANIA	12/12/2020 17:18	13/12/2020 10:59	12/12/2020 17:18	13/12/2020 10:59	17,67	1	17,67	CHI
20201268258	AGUAS LINDAS DE GOIAS	SN12103544	AGUAS LINDAS DE GOIAS S1	12/12/2020 17:18	12/12/2020 20:04	12/12/2020 17:18	12/12/2020 20:04	2,75	5	13,76	CHI
20201268153	NAZARIO	440016230	ANICUNS	12/12/2020 17:19	13/12/2020 08:13	12/12/2020 17:19	13/12/2020 08:13	14,90	1	14,90	CHI
20201268599	COCALZINHO DE GOIAS	CB12028344	COCALZINHO	12/12/2020 17:19	13/12/2020 00:21	12/12/2020 17:19	13/12/2020 00:21	7,02	4	28,10	CHI
20201268189	FIRMINOPOLIS	FR21096755	FIRMINOPOLIS S1	12/12/2020 17:20	12/12/2020 21:40	12/12/2020 17:20	12/12/2020 21:40	4,32	2	8,65	CHI
20201268232	NAZARIO	NZ11054734	ANICUNS	12/12/2020 17:20	13/12/2020 02:33	12/12/2020 17:20	13/12/2020 02:33	9,20	224	2060,92	CHI
20201268768	ABADIANIA	AX12221526	ALEXANIA	12/12/2020 17:20	12/12/2020 20:22	12/12/2020 17:20	12/12/2020 20:22	3,02	13	39,28	CHI
20201268768	ALEXANIA	AX12221526	ALEXANIA	12/12/2020 17:20	12/12/2020 20:22	12/12/2020 17:20	12/12/2020 20:22	3,02	190	574,12	CHI
20201268201	MORRINHOS	MR12041262RE	MORRINHOS	12/12/2020 17:22	12/12/2020 20:17	12/12/2020 17:22	12/12/2020 20:17	2,91	170	494,79	CHI
20201268205	COCALZINHO DE GOIAS	ZN11327425	GOIANESIA S1	12/12/2020 17:22	13/12/2020 13:38	12/12/2020 17:22	13/12/2020 13:38	20,26	1	20,26	CHI
20201268220	SILVANIA	VN10394751	VIANOPOLIS	12/12/2020 17:22	13/12/2020 13:05	12/12/2020 17:22	12/12/2020 22:23	5,01	146	730,89	CHI

20201268220	VIANOPOLIS	VN10394751	VIANOPOLIS	12/12/2020 17:22	13/12/2020 13:05	12/12/2020 17:22	12/12/2020 22:23	5,01	238	1191,45	CHI
20201268220	VIANOPOLIS	VN10394751	VIANOPOLIS	12/12/2020 17:22	13/12/2020 13:05	12/12/2020 22:29	13/12/2020 09:01	10,53	74	779,45	CHI
20201268220	SILVANIA	VN13375901	VIANOPOLIS	12/12/2020 17:22	13/12/2020 13:05	12/12/2020 22:29	13/12/2020 09:09	10,68	124	1323,94	CHI
20201268220	VIANOPOLIS	VN13375901	VIANOPOLIS	12/12/2020 17:22	13/12/2020 13:05	12/12/2020 22:29	13/12/2020 09:09	10,68	47	501,82	CHI
20201268220	VIANOPOLIS	VN12400021	VIANOPOLIS	12/12/2020 17:22	13/12/2020 13:05	12/12/2020 22:29	13/12/2020 11:43	13,23	116	1534,68	CHI
20201268220	LUZIANIA	LZ13261293	VIANOPOLIS	12/12/2020 17:22	13/12/2020 13:05	12/12/2020 17:22	13/12/2020 13:01	19,65	4	78,59	CHI
20201268220	SILVANIA	LZ13261293	VIANOPOLIS	12/12/2020 17:22	13/12/2020 13:05	12/12/2020 17:22	13/12/2020 13:01	19,65	2	39,30	CHI
20201268220	ORIZONA	LZ13261293	VIANOPOLIS	12/12/2020 17:22	13/12/2020 13:05	12/12/2020 17:22	13/12/2020 13:01	19,65	1	19,65	CHI
20201268220	VIANOPOLIS	LZ13168077	VIANOPOLIS	12/12/2020 17:22	13/12/2020 13:05	12/12/2020 22:29	13/12/2020 13:05	14,60	1	14,60	CHI
20201268220	SILVANIA	LZ13168077	VIANOPOLIS	12/12/2020 17:22	13/12/2020 13:05	12/12/2020 22:29	13/12/2020 13:05	14,60	22	321,13	CHI
20201268394	SENADOR CANEDO	SW11130677	SENADOR CANEDO	12/12/2020 17:23	12/12/2020 23:44	12/12/2020 17:23	12/12/2020 23:44	6,35	155	983,99	CHI
20201268746	ALEXANIA	AX12000165	ALEXANIA	12/12/2020 17:23	12/12/2020 21:19	12/12/2020 17:23	12/12/2020 21:19	3,92	2	7,84	CHI
20201268746	CORUMBA DE GOIAS	AX12000165	ALEXANIA	12/12/2020 17:23	12/12/2020 21:19	12/12/2020 17:23	12/12/2020 21:19	3,92	64	250,92	CHI
20201268746	ABADIANIA	AX12000165	ALEXANIA	12/12/2020 17:23	12/12/2020 21:19	12/12/2020 17:23	12/12/2020 21:19	3,92	8	31,36	CHI
20201268223	GOIANESIA	550177085	GOIANESIA S2	12/12/2020 17:24	13/12/2020 21:11	12/12/2020 17:24	13/12/2020 21:11	27,78	1	27,78	CHI
20201268229	GOIANIA	10016211950	ATLANTICO S3	12/12/2020 17:25	12/12/2020 19:45	12/12/2020 17:25	12/12/2020 19:45	2,32	1	2,32	CHI
20201268231	COCALZINHO DE GOIAS	ZN21125098	AGUAS LINDAS DE GOIAS S2	12/12/2020 17:25	12/12/2020 21:06	12/12/2020 17:25	12/12/2020 21:06	3,67	1	3,67	CHI
20201268240	AGUAS LINDAS DE GOIAS	4830358854	AGUAS LINDAS DE GOIAS S1	12/12/2020 17:26	12/12/2020 18:43	12/12/2020 17:26	12/12/2020 18:43	1,27	1	1,27	CHI
20201268243	MINEIROS	1390001857	PARQUE DAS EMAS	12/12/2020 17:26	12/12/2020 21:26	12/12/2020 17:26	12/12/2020 21:26	4,00	1	4,00	CHI
20201268581	ALEXANIA	AX12297688	ALEXANIA	12/12/2020 17:28	13/12/2020 07:31	12/12/2020 17:28	13/12/2020 07:31	14,04	7	98,28	CHI
20201268262	PADRE BERNARDO	PB12275496	PADRE BERNARDO	12/12/2020 17:29	12/12/2020 19:59	12/12/2020 17:29	12/12/2020 19:59	2,50	16	39,93	CHI
20201268898	IPAMERI	IP12017029	IPAMERI	12/12/2020 17:30	12/12/2020 20:22	12/12/2020 17:30	12/12/2020 20:22	2,86	15	42,87	CHI
20201268280	APARECIDA DE GOIANIA	AP11154044	ANHANGUERA	12/12/2020 17:31	12/12/2020 20:40	12/12/2020 17:31	12/12/2020 20:40	3,15	194	610,78	CHI
20201268284	ITAPURANGA	170046102	ITAPURANGA	12/12/2020 17:31	13/12/2020 10:05	12/12/2020 17:31	13/12/2020 10:05	16,56	1	16,56	CHI
20201268286	CRISTALINA	KR21237814	CRISTALINA S1	12/12/2020 17:31	12/12/2020 19:50	12/12/2020 17:31	12/12/2020 19:50	2,31	1	2,31	CHI
20201268642	VILA BOA	VB12265366	ITUIQUIRA	12/12/2020 17:31	12/12/2020 22:53	12/12/2020 17:31	12/12/2020 22:53	5,37	54	289,72	CHI
20201268305	CORUMBA DE GOIAS	AX12061983	ALEXANIA	12/12/2020 17:32	12/12/2020 21:34	12/12/2020 17:32	12/12/2020 21:34	4,02	1	4,02	CHI
20201268305	ALEXANIA	AX12061983	ALEXANIA	12/12/2020 17:32	12/12/2020 21:34	12/12/2020 17:32	12/12/2020 21:34	4,02	15	60,33	CHI
20201268302	JARAGUA	JA21121777	JARAGUA	12/12/2020 17:33	13/12/2020 11:58	12/12/2020 17:33	13/12/2020 11:58	18,41	1	18,41	CHI
20201268756	MIMOSO DE GOIAS	MJ12377232	PADRE BERNARDO	12/12/2020 17:33	13/12/2020 08:17	12/12/2020 17:33	13/12/2020 08:17	14,73	15	220,95	CHI
20201268308	PARAUNA	980028693	PARAUNA	12/12/2020 17:34	12/12/2020 23:27	12/12/2020 17:34	12/12/2020 23:27	5,88	1	5,88	CHI
20201268669	ITAUCU	IX12322432	INHUMAS S1	12/12/2020 17:34	12/12/2020 22:17	12/12/2020 17:34	12/12/2020 22:17	4,71	5	23,54	CHI
20201269334	GOIANESIA	GE12360291	GOIANESIA S2	12/12/2020 17:34	14/12/2020 09:23	12/12/2020 17:34	14/12/2020 09:23	39,81	8	318,49	CHI
20201268318	FORMOSO	FO21285225	MARA ROSA	12/12/2020 17:35	13/12/2020 11:47	12/12/2020 17:35	13/12/2020 11:47	18,19	1	18,19	CHI
20201268319	CAIAPONIA	PY12207987LD	PALESTINA	12/12/2020 17:36	12/12/2020 19:24	12/12/2020 17:36	12/12/2020 19:24	1,80	39	70,14	CHI
20201268321	PORTEIROAO	GT12030782	RIO DOS BOIS	12/12/2020 17:36	12/12/2020 19:58	12/12/2020 17:36	12/12/2020 19:58	2,36	3	7,07	CHI
20201268321	GOIATUBA	GT12030782	RIO DOS BOIS	12/12/2020 17:36	12/12/2020 19:58	12/12/2020 17:36	12/12/2020 19:58	2,36	1	2,36	CHI
20201268323	SANTO ANTONIO DO DESCOBERTO	SN12103504	ALEXANIA	12/12/2020 17:36	12/12/2020 19:36	12/12/2020 17:36	12/12/2020 19:36	1,99	1	1,99	CHI
20201268329	APARECIDA DE GOIANIA	200369880	INDEPENDENCIA S2	12/12/2020 17:37	12/12/2020 19:03	12/12/2020 17:37	12/12/2020 19:03	1,42	1	1,42	CHI
20201268392	ABADIANIA	AA12295520	ANAPOLIS UNIVERSITARIO S1	12/12/2020 17:37	12/12/2020 20:58	12/12/2020 17:37	12/12/2020 20:58	3,34	6	20,03	CHI
20201268591	URUACU	UR13317218	URUACU	12/12/2020 17:37	12/12/2020 23:15	12/12/2020 17:37	12/12/2020 20:05	2,48	132	327,43	CHI
20201268591	URUACU	UR13292495	URUACU	12/12/2020 17:37	12/12/2020 23:15	12/12/2020 17:37	12/12/2020 21:29	3,88	89	345,42	CHI
20201268591	HIDROLINA	UR13292491	URUACU	12/12/2020 17:37	12/12/2020 23:15	12/12/2020 17:37	12/12/2020 22:36	4,99	72	359,46	CHI
20201268591	PILAR DE GOIAS	UR13292491	URUACU	12/12/2020 17:37	12/12/2020 23:15	12/12/2020 17:37	12/12/2020 22:36	4,99	24	119,82	CHI
20201268591	URUACU	UR13292491	URUACU	12/12/2020 17:37	12/12/2020 23:15	12/12/2020 17:37	12/12/2020 22:36	4,99	27	134,80	CHI
20201268591	HIDROLINA	UR12243633RE	URUACU	12/12/2020 17:37	12/12/2020 23:15	12/12/2020 17:37	12/12/2020 23:15	5,65	5	28,23	CHI
20201268591	NOVA IGUACU DE GOIAS	UR12243633RE	URUACU	12/12/2020 17:37	12/12/2020 23:15	12/12/2020 17:37	12/12/2020 23:15	5,65	1	5,65	CHI
20201268591	PILAR DE GOIAS	UR12243633RE	URUACU	12/12/2020 17:37	12/12/2020 23:15	12/12/2020 17:37	12/12/2020 23:15	5,65	1	5,65	CHI
20201268591	URUACU	UR12243633RE	URUACU	12/12/2020 17:37	12/12/2020 23:15	12/12/2020 17:37	12/12/2020 23:15	5,65	101	570,20	CHI
2020121200076	GUARINOS	14902	URUACU	12/12/2020 17:37	12/12/2020 20:05	12/12/2020 17:37	12/12/2020 20:05	2,47	11	27,13	CHI
2020121200076	PILAR DE GOIAS	07931	URUACU	12/12/2020 17:37	12/12/2020 20:05	12/12/2020 17:37	12/12/2020 20:05	2,47	42	103,60	CHI

2020121200076	PILAR DE GOIAS	14901	URUACU	12/12/2020 17:37	12/12/2020 20:05	12/12/2020 17:37	12/12/2020 20:05	2,47	62	152,93	CHI
2020121200076	HIDROLINA	07931	URUACU	12/12/2020 17:37	12/12/2020 20:05	12/12/2020 17:37	12/12/2020 20:05	2,47	115	283,67	CHI
2020121200076	PILAR DE GOIAS	14902	URUACU	12/12/2020 17:37	12/12/2020 20:05	12/12/2020 17:37	12/12/2020 20:05	2,47	718	1771,07	CHI
2020121200076	ITAPACI	14902	URUACU	12/12/2020 17:37	12/12/2020 20:05	12/12/2020 17:37	12/12/2020 20:05	2,47	2	4,93	CHI
2020121200076	HIDROLINA	07901	URUACU	12/12/2020 17:37	12/12/2020 20:05	12/12/2020 17:37	12/12/2020 20:05	2,47	1205	2972,33	CHI
2020121200076	SANTA TEREZINHA DE GOIAS	14902	URUACU	12/12/2020 17:37	12/12/2020 20:05	12/12/2020 17:37	12/12/2020 20:05	2,47	5	12,33	CHI
20201269356	ALEXANIA	AX12095958	CORUMBA	12/12/2020 17:38	13/12/2020 18:15	12/12/2020 17:38	13/12/2020 18:15	24,61	7	172,26	CHI
20201269356	CORUMBA DE GOIAS	AX12095958	CORUMBA	12/12/2020 17:38	13/12/2020 18:15	12/12/2020 17:38	13/12/2020 18:15	24,61	3	73,83	CHI
20201268336	GOIANIA	12687420	XAVANTES	12/12/2020 17:39	12/12/2020 19:58	12/12/2020 17:39	12/12/2020 19:58	2,31	1	2,31	CHI
20201268345	PIRES DO RIO	460108724	PIRES DO RIO S1	12/12/2020 17:40	13/12/2020 07:50	12/12/2020 17:40	13/12/2020 07:50	14,16	1	14,16	CHI
20201268352	HIDROLANDIA	HD11242147	CEPAIGO S2	12/12/2020 17:41	12/12/2020 20:23	12/12/2020 17:41	12/12/2020 20:23	2,70	17	45,84	CHI
20201268353	ANICUNS	910008700	ANICUNS	12/12/2020 17:41	13/12/2020 07:24	12/12/2020 17:41	13/12/2020 07:24	13,71	1	13,71	CHI
20201268354	URUTAI	UT21417472	PIRES DO RIO S2	12/12/2020 17:41	13/12/2020 22:37	12/12/2020 17:41	13/12/2020 22:37	28,93	1	28,93	CHI
20201268354	URUTAI	UT12337239	PIRES DO RIO S2	12/12/2020 17:41	13/12/2020 22:37	13/12/2020 20:25	13/12/2020 22:37	2,20	9	19,80	CHI
20201268355	SITIO D ABADIA	SI12234157	IACIARA S2	12/12/2020 17:41	12/12/2020 21:28	12/12/2020 17:41	12/12/2020 21:28	3,77	12	45,27	CHI
20201268356	RUBIATABA	780081560	RUBIATABA	12/12/2020 17:41	12/12/2020 22:41	12/12/2020 17:41	12/12/2020 22:41	4,99	1	4,99	CHI
202012132278	PALMEIRAS DE GOIAS	04880214	PALMEIRAS	12/12/2020 17:41	13/12/2020 14:49	12/12/2020 17:41	12/12/2020 20:19	2,63	7	18,43	CHI
202012132278	CEZARINA	PL10404073	PALMEIRAS	12/12/2020 17:41	13/12/2020 14:49	12/12/2020 17:41	12/12/2020 20:49	3,12	4	12,48	CHI
202012132278	PALMEIRAS DE GOIAS	PL10404073	PALMEIRAS	12/12/2020 17:41	13/12/2020 14:49	12/12/2020 17:41	12/12/2020 20:49	3,12	273	851,99	CHI
202012132278	PALMEIRAS DE GOIAS	04880214	PALMEIRAS	12/12/2020 17:41	13/12/2020 14:49	12/12/2020 17:41	12/12/2020 20:49	3,12	32	99,87	CHI
202012132278	PALMEIRAS DE GOIAS	04880214	PALMEIRAS	12/12/2020 17:41	13/12/2020 14:49	12/12/2020 17:41	13/12/2020 04:09	10,47	3	31,40	CHI
202012132278	PALMEIRAS DE GOIAS	04880406	PALMEIRAS	12/12/2020 17:41	13/12/2020 14:49	13/12/2020 01:05	13/12/2020 04:09	3,08	312	961,83	CHI
202012132278	CEZARINA	04880406	PALMEIRAS	12/12/2020 17:41	13/12/2020 14:49	13/12/2020 01:05	13/12/2020 04:09	3,08	4	12,33	CHI
202012132278	PALMEIRAS DE GOIAS	04880406	PALMEIRAS	12/12/2020 17:41	13/12/2020 14:49	13/12/2020 01:05	13/12/2020 04:10	3,10	142	439,61	CHI
202012132278	PALMEIRAS DE GOIAS	04880214	PALMEIRAS	12/12/2020 17:41	13/12/2020 14:49	12/12/2020 17:41	13/12/2020 04:59	11,29	13	146,72	CHI
202012132278	CEZARINA	04880214	PALMEIRAS	12/12/2020 17:41	13/12/2020 14:49	12/12/2020 17:41	13/12/2020 14:49	21,12	1	21,12	CHI
202012132278	PALMEIRAS DE GOIAS	04880214	PALMEIRAS	12/12/2020 17:41	13/12/2020 14:49	12/12/2020 17:41	13/12/2020 14:49	21,12	83	1752,94	CHI
202012132278	INDIARA	04880214	PALMEIRAS	12/12/2020 17:41	13/12/2020 14:49	12/12/2020 17:41	13/12/2020 14:49	21,12	3	63,36	CHI
202012132278	PALMEIRAS DE GOIAS	PL12129777LD	PALMEIRAS	12/12/2020 17:41	13/12/2020 14:49	13/12/2020 08:34	13/12/2020 14:49	6,24	16	99,84	CHI
20201268359	BURITI ALEGRE	BG21000140	ITUMBIARA VELHA S2	12/12/2020 17:42	13/12/2020 02:32	12/12/2020 17:42	13/12/2020 02:32	8,83	1	8,83	CHI
20201268361	SANTO ANTONIO DO DESCOBERTO	SN21086752	ALEXANIA	12/12/2020 17:42	13/12/2020 09:42	12/12/2020 17:42	13/12/2020 09:42	15,99	1	15,99	CHI
20201268362	ALEXANIA	AX12061866	ALEXANIA	12/12/2020 17:42	13/12/2020 09:50	12/12/2020 17:42	13/12/2020 09:50	16,13	2	32,26	CHI
20201268364	NOVA GLORIA	NG12181341	RUBIATABA	12/12/2020 17:42	13/12/2020 16:52	12/12/2020 17:42	13/12/2020 16:52	23,16	5	115,79	CHI
20201268660	ABADIANA	AA12221425	ANAPOLIS UNIVERSITARIO S1	12/12/2020 17:42	12/12/2020 22:40	12/12/2020 17:42	12/12/2020 22:40	4,97	45	223,49	CHI
20201268660	GAMELEIRA DE GOIAS	AA12221425	ANAPOLIS UNIVERSITARIO S1	12/12/2020 17:42	12/12/2020 22:40	12/12/2020 17:42	12/12/2020 22:40	4,97	1	4,97	CHI
20201268371	CACHOEIRA ALTA	CA21226908	CACHOEIRA ALTA	12/12/2020 17:43	12/12/2020 18:57	12/12/2020 17:43	12/12/2020 18:57	1,22	2	2,44	CHI
20201268419	JATAI	RV12189232	CABRIUVA S1	12/12/2020 17:43	12/12/2020 20:50	12/12/2020 17:43	12/12/2020 20:50	3,12	1	3,12	CHI
20201268419	RIO VERDE	RV12189232	CABRIUVA S1	12/12/2020 17:43	12/12/2020 20:50	12/12/2020 17:43	12/12/2020 20:50	3,12	8	24,93	CHI
20201268374	CAMPESTRE DE GOIAS	1230007122	TRINDADE	12/12/2020 17:44	12/12/2020 19:08	12/12/2020 17:44	12/12/2020 19:08	1,40	1	1,40	CHI
20201268515	GOIANIA	GN12132623	GOYA S2	12/12/2020 17:44	12/12/2020 21:30	12/12/2020 17:44	12/12/2020 21:30	3,76	142	533,96	CHI
20201268598	GUARAITA	GK12299432	ITAPURANGA	12/12/2020 17:44	12/12/2020 19:54	12/12/2020 17:44	12/12/2020 19:54	2,17	150	324,83	CHI
20201268598	GOIAS	GK12299432	ITAPURANGA	12/12/2020 17:44	12/12/2020 19:54	12/12/2020 17:44	12/12/2020 19:54	2,17	31	67,13	CHI
20201268386	PADRE BERNARDO	PB12251049	PADRE BERNARDO	12/12/2020 17:45	13/12/2020 12:06	12/12/2020 17:45	13/12/2020 12:06	18,36	5	91,78	CHI
20201268397	CIDADE OCIDENTAL	2680128285	MARAJOA RA	12/12/2020 17:47	12/12/2020 23:32	12/12/2020 17:47	12/12/2020 23:32	5,75	1	5,75	CHI
20201270639	CRIXAS	CX12297041	SERRA DO OURO	12/12/2020 17:47	13/12/2020 10:07	12/12/2020 17:47	13/12/2020 10:07	16,33	1	16,33	CHI
20201268401	ITABERAI	IB21244937	ITABERAI S1	12/12/2020 17:48	13/12/2020 13:30	12/12/2020 17:48	13/12/2020 13:30	19,69	8	157,55	CHI
20201268404	SAO LUIS DE MONTES BELOS	SL21111638	FIRMINOPOLIS S1	12/12/2020 17:48	13/12/2020 01:28	12/12/2020 17:48	13/12/2020 01:28	7,66	2	15,31	CHI
20201268405	PALMEIRAS DE GOIAS	PL21158234	PALMEIRAS	12/12/2020 17:48	13/12/2020 19:07	12/12/2020 17:48	13/12/2020 19:07	25,31	1	25,31	CHI
20201268406	CALDAS NOVAS	760237920	SERRA DE CALDAS	12/12/2020 17:48	13/12/2020 09:23	12/12/2020 17:48	13/12/2020 09:23	15,57	1	15,57	CHI
20201268416	SANTO ANTONIO DO DESCOBERTO	SN12246920	AGUAS LINDAS DE GOIAS S2	12/12/2020 17:49	12/12/2020 20:43	12/12/2020 17:49	12/12/2020 20:43	2,89	20	57,90	CHI
20201268416	COCALZINHO DE GOIAS	SN12246920	AGUAS LINDAS DE GOIAS S2	12/12/2020 17:49	12/12/2020 20:43	12/12/2020 17:49	12/12/2020 20:43	2,89	5	14,47	CHI

20201268422	FORMOSA	610093204	ITUIQUIRA	12/12/2020 17:49	13/12/2020 01:56	12/12/2020 17:49	13/12/2020 01:56	8,10	1	8,10	CHI
20201268423	SANTA TEREZINHA DE GOIAS	SG12380710	SANTA TEREZINHA	12/12/2020 17:49	12/12/2020 19:52	12/12/2020 17:49	12/12/2020 19:52	2,05	8	16,39	CHI
20201268426	PIRANHAS	1930035709	PIRANHAS	12/12/2020 17:50	13/12/2020 00:31	12/12/2020 17:50	13/12/2020 00:31	6,67	1	6,67	CHI
20201268429	RIO VERDE	RV12271292	CABRIUVA S2	12/12/2020 17:50	13/12/2020 15:30	12/12/2020 17:50	13/12/2020 15:30	21,67	4	86,67	CHI
20201268436	GOIANIA	12168154	GOIANIA LESTE S2	12/12/2020 17:51	12/12/2020 21:35	12/12/2020 17:51	12/12/2020 21:35	3,72	1	3,72	CHI
20201268486	SANTA ROSA DE GOIAS	SR12019043	INHUMAS S1	12/12/2020 17:51	13/12/2020 15:33	12/12/2020 17:51	13/12/2020 15:33	21,70	3	65,09	CHI
20201268452	ALEXANIA	AX12317789	ALEXANIA	12/12/2020 17:52	12/12/2020 23:19	12/12/2020 17:52	12/12/2020 23:19	5,43	14	76,07	CHI
20201268443	GUARAITA	10022076024	ITAPURANGA	12/12/2020 17:53	13/12/2020 10:39	12/12/2020 17:53	13/12/2020 10:39	16,76	1	16,76	CHI
20201268446	GOIANIA	15649027	ATLANTICO S2	12/12/2020 17:53	12/12/2020 20:08	12/12/2020 17:53	12/12/2020 20:08	2,24	1	2,24	CHI
20201268448	MINEIROS	1390066724	PARQUE DAS EMAS	12/12/2020 17:53	12/12/2020 23:04	12/12/2020 17:53	12/12/2020 23:04	5,18	1	5,18	CHI
20201268644	PIRES DO RIO	PR12000074	PIRES DO RIO S1	12/12/2020 17:53	12/12/2020 19:22	12/12/2020 17:53	12/12/2020 19:22	1,47	6	8,81	CHI
20201269120	PIRACANJUBA	PJ12223375	ROCHEDO	12/12/2020 17:54	13/12/2020 08:30	12/12/2020 17:54	13/12/2020 08:30	14,59	3	43,78	CHI
20201268459	SAO MIGUEL DO ARAGUAIA	SM12059987	SAO MIGUEL DO ARAGUAIA	12/12/2020 17:55	13/12/2020 03:36	12/12/2020 17:55	13/12/2020 03:36	9,69	3	29,06	CHI
20201268467	PLANALTINA	2960007147	PLANALTINA	12/12/2020 17:55	12/12/2020 18:53	12/12/2020 17:55	12/12/2020 18:53	0,95	1	0,95	CHI
20201268546	SANTO ANTONIO DO DESCOBERTO	SN11128752	AGUAS LINDAS DE GOIAS S2	12/12/2020 17:55	12/12/2020 22:13	12/12/2020 17:55	12/12/2020 22:13	4,29	67	287,76	CHI
20201269255	MINACU	IH12063612	MINACU	12/12/2020 17:56	12/12/2020 22:18	12/12/2020 17:56	12/12/2020 22:18	4,35	413	1796,89	CHI
20201268550	DIORAMA	DI12065691	IPORA	12/12/2020 17:57	12/12/2020 22:05	12/12/2020 17:57	12/12/2020 22:05	4,13	8	33,01	CHI
20201270650	CAVALCANTE	CJ12239935	FLORES DE GOIAS	12/12/2020 17:57	13/12/2020 10:04	12/12/2020 17:57	13/12/2020 10:04	16,11	126	2029,44	CHI
20201268477	FAINA	GS12064979	ITAPURANGA	12/12/2020 17:58	13/12/2020 08:55	12/12/2020 17:58	13/12/2020 08:55	14,95	3	44,85	CHI
20201268477	GOIAS	GS12064979	ITAPURANGA	12/12/2020 17:58	13/12/2020 08:55	12/12/2020 17:58	13/12/2020 08:55	14,95	1	14,95	CHI
20201268479	JUSSARA	JR12160186	BRITANIA	12/12/2020 17:58	13/12/2020 13:12	12/12/2020 17:58	13/12/2020 13:12	19,23	3	57,69	CHI
20201268914	ALEXANIA	AX12000005	ALEXANIA	12/12/2020 17:58	12/12/2020 22:37	12/12/2020 17:58	12/12/2020 22:37	4,64	12	55,70	CHI
20201268516	ANAPOLIS	AN10384400	DAIA S2	12/12/2020 17:59	13/12/2020 14:20	12/12/2020 17:59	12/12/2020 18:59	1,00	2	1,99	CHI
20201268516	LEOPOLDO DE BULHOES	AN10384400	DAIA S2	12/12/2020 17:59	13/12/2020 14:20	12/12/2020 17:59	12/12/2020 18:59	1,00	14	13,96	CHI
20201268516	SILVANIA	AN10384400	DAIA S2	12/12/2020 17:59	13/12/2020 14:20	12/12/2020 17:59	12/12/2020 18:59	1,00	5	4,99	CHI
20201268516	ANAPOLIS	AN10384400	DAIA S2	12/12/2020 17:59	13/12/2020 14:20	12/12/2020 20:39	12/12/2020 20:50	0,17	2	0,35	CHI
20201268516	SILVANIA	AN10384400	DAIA S2	12/12/2020 17:59	13/12/2020 14:20	12/12/2020 20:39	12/12/2020 20:50	0,17	5	0,87	CHI
20201268516	LEOPOLDO DE BULHOES	AN10384400	DAIA S2	12/12/2020 17:59	13/12/2020 14:20	12/12/2020 20:39	12/12/2020 20:50	0,17	14	2,45	CHI
20201268516	LEOPOLDO DE BULHOES	AN10384400	DAIA S2	12/12/2020 17:59	13/12/2020 14:20	12/12/2020 17:59	13/12/2020 04:13	10,23	3	30,68	CHI
20201268516	SILVANIA	AN10384400	DAIA S2	12/12/2020 17:59	13/12/2020 14:20	12/12/2020 17:59	13/12/2020 04:13	10,23	1	10,23	CHI
20201268516	SILVANIA	AN10384400	DAIA S2	12/12/2020 17:59	13/12/2020 14:20	12/12/2020 17:59	13/12/2020 12:27	18,46	11	203,08	CHI
20201268516	LEOPOLDO DE BULHOES	AN10384400	DAIA S2	12/12/2020 17:59	13/12/2020 14:20	12/12/2020 17:59	13/12/2020 12:27	18,46	9	166,15	CHI
20201268516	SILVANIA	LB13347835	DAIA S2	12/12/2020 17:59	13/12/2020 14:20	13/12/2020 13:58	13/12/2020 14:20	0,37	1	0,37	CHI
20201268516	LEOPOLDO DE BULHOES	LB13347835	DAIA S2	12/12/2020 17:59	13/12/2020 14:20	13/12/2020 13:58	13/12/2020 14:20	0,37	3	1,10	CHI
20201268535	SILVANIA	SV10401430	VIANOPOLIS	12/12/2020 17:59	12/12/2020 20:40	12/12/2020 17:59	12/12/2020 18:02	0,05	39	2,00	CHI
20201268535	LEOPOLDO DE BULHOES	SV10401430	VIANOPOLIS	12/12/2020 17:59	12/12/2020 20:40	12/12/2020 17:59	12/12/2020 18:02	0,05	4	0,21	CHI
20201268535	LEOPOLDO DE BULHOES	SV10401430	DAIA S2	12/12/2020 17:59	12/12/2020 20:40	12/12/2020 17:59	12/12/2020 20:37	2,64	1891	4983,31	CHI
20201268535	SILVANIA	SV10401430	DAIA S2	12/12/2020 17:59	12/12/2020 20:40	12/12/2020 17:59	12/12/2020 20:37	2,64	249	656,18	CHI
20201268535	BELA VISTA DE GOIAS	SV10401430	DAIA S2	12/12/2020 17:59	12/12/2020 20:40	12/12/2020 17:59	12/12/2020 20:37	2,64	8	21,08	CHI
20201268535	GAMELEIRA DE GOIAS	SV10401430	DAIA S2	12/12/2020 17:59	12/12/2020 20:40	12/12/2020 17:59	12/12/2020 20:40	2,68	27	72,35	CHI
20201268535	BELA VISTA DE GOIAS	SV10401430	DAIA S2	12/12/2020 17:59	12/12/2020 20:40	12/12/2020 17:59	12/12/2020 20:40	2,68	1	2,68	CHI
20201268535	CALDAZINHA	SV10401430	DAIA S2	12/12/2020 17:59	12/12/2020 20:40	12/12/2020 17:59	12/12/2020 20:40	2,68	70	187,58	CHI
20201268535	SILVANIA	SV10401430	DAIA S2	12/12/2020 17:59	12/12/2020 20:40	12/12/2020 17:59	12/12/2020 20:40	2,68	315	844,11	CHI
20201268535	LEOPOLDO DE BULHOES	SV10401430	DAIA S2	12/12/2020 17:59	12/12/2020 20:40	12/12/2020 17:59	12/12/2020 20:40	2,68	1084	2904,82	CHI
20201268491	PIRACANJUBA	PJ21105765	MORRINHOS	12/12/2020 18:00	13/12/2020 11:02	12/12/2020 18:00	13/12/2020 11:02	17,03	1	17,03	CHI
20201268892	GOIAS	HE10395398	ITAPURANGA	12/12/2020 18:00	13/12/2020 15:44	12/12/2020 18:00	12/12/2020 21:50	3,82	4	15,29	CHI
20201268892	HEITORAI	HE10395398	ITAPURANGA	12/12/2020 18:00	13/12/2020 15:44	12/12/2020 18:00	12/12/2020 21:50	3,82	44	168,19	CHI
20201268892	GOIAS	HE12300134LD	ITAPURANGA	12/12/2020 18:00	13/12/2020 15:44	12/12/2020 18:00	13/12/2020 15:33	21,55	40	861,90	CHI
20201268892	GOIAS	GS12022123	ITAPURANGA	12/12/2020 18:00	13/12/2020 15:44	12/12/2020 18:00	13/12/2020 15:44	21,72	22	477,83	CHI
20201268892	HEITORAI	GS12022123	ITAPURANGA	12/12/2020 18:00	13/12/2020 15:44	12/12/2020 18:00	13/12/2020 15:44	21,72	6	130,32	CHI
20201268504	GOIAS	GS21259621	GOIAS	12/12/2020 18:01	13/12/2020 09:12	12/12/2020 18:01	13/12/2020 09:12	15,18	1	15,18	CHI

20201269087	GAMELEIRA DE GOIAS	GL12389474	DAIA S2	12/12/2020 18:01	13/12/2020 09:21	12/12/2020 18:01	13/12/2020 09:21	15,33	32	490,57	CHI
20201269087	ANAPOLIS	GL12389474	DAIA S2	12/12/2020 18:01	13/12/2020 09:21	12/12/2020 18:01	13/12/2020 09:21	15,33	4	61,32	CHI
20201269111	ITAPIRAPUA	IU12014848	MATRINCHA	12/12/2020 18:02	13/12/2020 12:04	12/12/2020 18:02	13/12/2020 12:04	18,03	58	1045,98	CHI
20201269709	TURVELANDIA	ML12213272LD	RIO DOS BOIS	12/12/2020 18:02	13/12/2020 08:53	12/12/2020 18:02	13/12/2020 08:53	14,84	3	44,53	CHI
20201258981	MINACU	IH12334428	MINACU	12/12/2020 18:03	13/12/2020 08:35	12/12/2020 18:03	13/12/2020 08:35	14,54	188	2733,42	CHI
20201268521	CAMPO ALEGRE DE GOIAS	CM21154707	CAMPO ALEGRE DE GOIAS	12/12/2020 18:03	13/12/2020 08:42	12/12/2020 18:03	13/12/2020 08:42	14,64	1	14,64	CHI
20201268522	LUZIANIA	LZ21000583	MARAJOARA	12/12/2020 18:03	12/12/2020 22:51	12/12/2020 18:03	12/12/2020 22:51	4,79	1	4,79	CHI
20201268686	IPAMERI	IP12266905	IPAMERI	12/12/2020 18:03	12/12/2020 21:05	12/12/2020 18:03	12/12/2020 21:05	3,02	4	12,07	CHI
20201268526	GOIANIA	GN11111855	XAVANTES	12/12/2020 18:04	12/12/2020 21:30	12/12/2020 18:04	12/12/2020 21:30	3,42	186	635,91	CHI
20201268530	MINACU	4020082973	MINACU	12/12/2020 18:05	13/12/2020 15:37	12/12/2020 18:05	13/12/2020 15:37	21,53	1	21,53	CHI
20201268536	SANCLERLANDIA	SC21032587	FIRMINOPOLIS S2	12/12/2020 18:06	12/12/2020 20:00	12/12/2020 18:06	12/12/2020 20:00	1,90	1	1,90	CHI
20201268540	CALDAS NOVAS	CN12354071	CALDAS NOVAS S1	12/12/2020 18:06	12/12/2020 19:21	12/12/2020 18:06	12/12/2020 19:21	1,24	5	6,20	CHI
20201268541	CALDAZINHA	BV21090620	CEPAIGO S2	12/12/2020 18:06	12/12/2020 20:26	12/12/2020 18:06	12/12/2020 20:26	2,32	1	2,32	CHI
20201268543	CRISTALINA	KR11170455	CRISTALINA S2	12/12/2020 18:07	12/12/2020 21:52	12/12/2020 18:07	12/12/2020 21:52	3,75	1	3,75	CHI
20201268544	RIO VERDE	630019848	RIO VERDE S2	12/12/2020 18:07	12/12/2020 21:11	12/12/2020 18:07	12/12/2020 21:11	3,06	1	3,06	CHI
20201268552	AGUAS LINDAS DE GOIAS	10011106407	AGUAS LINDAS DE GOIAS S1	12/12/2020 18:08	12/12/2020 19:42	12/12/2020 18:08	12/12/2020 19:42	1,55	1	1,55	CHI
20201268619	ANAPOLIS	AN12381272	ANAPOLIS UNIVERSITARIO S2	12/12/2020 18:08	13/12/2020 04:19	12/12/2020 18:08	13/12/2020 04:19	10,17	12	122,07	CHI
20201268643	PETROLINA DE GOIAS	PG12011518	PETROLINA	12/12/2020 18:09	13/12/2020 13:39	12/12/2020 18:09	13/12/2020 13:39	19,51	10	195,07	CHI
20201268656	AMERICANO DO BRASIL	KB12000014	ANICUNS	12/12/2020 18:09	13/12/2020 09:52	12/12/2020 18:09	13/12/2020 09:52	15,72	10	157,15	CHI
20201268565	ANICUNS	AC21158675	ANICUNS	12/12/2020 18:11	13/12/2020 12:49	12/12/2020 18:11	13/12/2020 12:49	18,63	1	18,63	CHI
20201268607	SANTA TEREZINHA DE GOIAS	2480029470	SANTA TEREZINHA	12/12/2020 18:17	12/12/2020 23:18	12/12/2020 18:17	12/12/2020 23:18	5,01	1	5,01	CHI
20201268621	HEITORAI	HE11224020	ITAPURANGA	12/12/2020 18:18	13/12/2020 17:02	12/12/2020 18:18	13/12/2020 17:02	22,72	1	22,72	CHI
20201268653	APORE	IJ10401500	ITAJA S2	12/12/2020 18:19	13/12/2020 16:11	12/12/2020 18:19	12/12/2020 22:16	3,95	4	15,79	CHI
20201268653	ITAJA	IJ10401500	ITAJA S2	12/12/2020 18:19	13/12/2020 16:11	12/12/2020 18:19	12/12/2020 22:16	3,95	92	363,09	CHI
20201268653	ITARUMA	IJ10401500	ITAJA S2	12/12/2020 18:19	13/12/2020 16:11	12/12/2020 18:19	12/12/2020 22:16	3,95	1	3,95	CHI
20201268653	ITAJA	IJ10401500	ITAJA S2	12/12/2020 18:19	13/12/2020 16:11	12/12/2020 18:19	12/12/2020 23:16	4,95	13	64,31	CHI
20201268653	ITARUMA	IJ10401500	ITAJA S2	12/12/2020 18:19	13/12/2020 16:11	12/12/2020 18:19	12/12/2020 23:16	4,95	38	187,99	CHI
20201268653	ITARUMA	IJ10401500	ITAJA S2	12/12/2020 18:19	13/12/2020 16:11	12/12/2020 23:35	12/12/2020 23:50	0,25	39	9,71	CHI
20201268653	ITAJA	IJ10401500	ITAJA S2	12/12/2020 18:19	13/12/2020 16:11	12/12/2020 23:35	12/12/2020 23:50	0,25	105	26,13	CHI
20201268653	APORE	IJ10401500	ITAJA S2	12/12/2020 18:19	13/12/2020 16:11	12/12/2020 23:35	12/12/2020 23:50	0,25	4	1,00	CHI
20201268653	ITARUMA	IM12205228LD	ITAJA S2	12/12/2020 18:19	13/12/2020 16:11	12/12/2020 18:19	13/12/2020 00:05	5,76	42	242,13	CHI
20201268653	ITARUMA	IJ10401500	ITAJA S2	12/12/2020 18:19	13/12/2020 16:11	13/12/2020 00:55	13/12/2020 01:26	0,52	81	42,16	CHI
20201268653	ITAJA	IJ10401500	ITAJA S2	12/12/2020 18:19	13/12/2020 16:11	13/12/2020 00:55	13/12/2020 01:26	0,52	105	54,66	CHI
20201268653	APORE	IJ10401500	ITAJA S2	12/12/2020 18:19	13/12/2020 16:11	13/12/2020 00:55	13/12/2020 01:26	0,52	4	2,08	CHI
20201268653	ITARUMA	IJ10401500	ITAJA S2	12/12/2020 18:19	13/12/2020 16:11	12/12/2020 18:19	13/12/2020 16:11	21,87	20	437,33	CHI
20201268639	GOIANIA	11150490	MEIA PONTE	12/12/2020 18:21	12/12/2020 20:56	12/12/2020 18:21	12/12/2020 20:56	2,57	1	2,57	CHI
20201268640	SILVANIA	SV12080222	VIANOPOLIS	12/12/2020 18:21	13/12/2020 12:28	12/12/2020 18:21	13/12/2020 12:28	18,11	5	90,53	CHI
20201268641	CAMPESTRE DE GOIAS	GA12000001RE	GUAPO S1	12/12/2020 18:21	13/12/2020 17:25	12/12/2020 18:21	13/12/2020 17:25	23,07	22	507,62	CHI
20201268641	TRINDADE	GA12000001RE	GUAPO S1	12/12/2020 18:21	13/12/2020 17:25	12/12/2020 18:21	13/12/2020 17:25	23,07	38	876,80	CHI
20201268641	GUAPO	GA12000001RE	GUAPO S1	12/12/2020 18:21	13/12/2020 17:25	12/12/2020 18:21	13/12/2020 17:25	23,07	104	2399,66	CHI
20201268655	PIRACANJUBA	PJ21223390	ROCHEDO	12/12/2020 18:24	13/12/2020 10:03	12/12/2020 18:24	13/12/2020 10:03	15,64	1	15,64	CHI
20201268663	SANTO ANTONIO DO DESCOBERTO	LA12401730	AGUAS LINDAS DE GOIAS S1	12/12/2020 18:25	12/12/2020 22:42	12/12/2020 18:25	12/12/2020 22:42	4,28	8	34,21	CHI
20201268673	GOIANIA	10004981020	XAVANTES	12/12/2020 18:27	12/12/2020 21:07	12/12/2020 18:27	12/12/2020 21:07	2,66	1	2,66	CHI
20201268675	ABADIANIA	AA12335610	ANAPOLIS UNIVERSITARIO S1	12/12/2020 18:27	13/12/2020 05:12	12/12/2020 18:27	13/12/2020 05:12	10,75	9	96,72	CHI
20201268679	RIO VERDE	630220440	RIO VERDE S1	12/12/2020 18:28	12/12/2020 22:28	12/12/2020 18:28	12/12/2020 22:28	4,00	1	4,00	CHI
20201268687	SAO DOMINGOS	SD21096858	IACIARA S2	12/12/2020 18:29	13/12/2020 00:37	12/12/2020 18:29	13/12/2020 00:37	6,13	1	6,13	CHI
20201268703	ALEXANIA	AX11388845	ALEXANIA	12/12/2020 18:30	12/12/2020 23:01	12/12/2020 18:30	12/12/2020 23:01	4,50	22	99,04	CHI
20201268706	GOIANIA	10000065690	CAMPINAS S2	12/12/2020 18:30	12/12/2020 23:22	12/12/2020 18:30	12/12/2020 23:22	4,85	1	4,85	CHI
20201268716	INACIOLANDIA	ID11305467	CACHOEIRA DOURADA	12/12/2020 18:31	12/12/2020 20:14	12/12/2020 18:31	12/12/2020 20:14	1,70	1	1,70	CHI
20201268717	APARECIDA DE GOIANIA	13866874	ATLANTICO S2	12/12/2020 18:31	12/12/2020 20:49	12/12/2020 18:31	12/12/2020 20:49	2,28	1	2,28	CHI
20201268718	CAMPINORTE	CR21372068	CAMPINORTE	12/12/2020 18:32	13/12/2020 04:10	12/12/2020 18:32	13/12/2020 04:10	9,63	2	19,27	CHI

20201268719	SANTO ANTONIO DO DESCOBERTO	2210075010	AGUAS LINDAS DE GOIAS S2	12/12/2020 18:32	13/12/2020 07:25	12/12/2020 18:32	13/12/2020 07:25	12,88	1	12,88	CHI
20201268723	JATAI	CP12147712	CAIAPONIA	12/12/2020 18:32	12/12/2020 21:59	12/12/2020 18:32	12/12/2020 21:59	3,46	3	10,37	CHI
20201268723	RIO VERDE	CP12147712	CAIAPONIA	12/12/2020 18:32	12/12/2020 21:59	12/12/2020 18:32	12/12/2020 21:59	3,46	4	13,82	CHI
20201268736	MINACU	IH12346526	MINACU	12/12/2020 18:33	13/12/2020 08:40	12/12/2020 18:33	12/12/2020 22:39	4,09	68	278,31	CHI
20201268736	MINACU	IH12346526	MINACU	12/12/2020 18:33	13/12/2020 08:40	12/12/2020 22:49	13/12/2020 08:40	9,83	69	678,60	CHI
20201268740	CALDAS NOVAS	CN12213834	CALDAS NOVAS S1	12/12/2020 18:33	12/12/2020 21:31	12/12/2020 18:33	12/12/2020 21:31	2,95	4	11,81	CHI
202012179355	CRIXAS	CX21342267	SANTA TEREZINHA	12/12/2020 18:33	14/12/2020 01:07	13/12/2020 10:41	13/12/2020 10:45	0,06	1	0,06	CHI
202012179355	CRIXAS	CX21277924	SANTA TEREZINHA	12/12/2020 18:33	14/12/2020 01:07	12/12/2020 18:33	14/12/2020 01:07	30,58	1	30,58	CHI
20201269422	PALMINOPOLIS	PP12233536	PALMEIRAS	12/12/2020 18:34	13/12/2020 10:02	12/12/2020 18:34	13/12/2020 10:02	15,45	1	15,45	CHI
20201269422	PALMEIRAS DE GOIAS	PP12233536	PALMEIRAS	12/12/2020 18:34	13/12/2020 10:02	12/12/2020 18:34	13/12/2020 10:02	15,45	11	169,98	CHI
20201268959	AGUAS LINDAS DE GOIAS	LA11108704	AGUAS LINDAS DE GOIAS S1	12/12/2020 18:35	12/12/2020 20:20	12/12/2020 18:35	12/12/2020 20:20	1,75	98	171,31	CHI
20201268760	SANTA CRUZ DE GOIAS	BC12031892	PIRES DO RIO S2	12/12/2020 18:36	12/12/2020 21:55	12/12/2020 18:36	12/12/2020 21:55	3,31	5	16,54	CHI
20201269279	SANTO ANTONIO DO DESCOBERTO	SN12087945	ALEXANIA	12/12/2020 18:39	12/12/2020 23:58	12/12/2020 18:39	12/12/2020 23:58	5,31	5	26,57	CHI
20201268781	APARECIDA DE GOIANIA	AP11140149	INDEPENDENCIA S2	12/12/2020 18:40	12/12/2020 23:19	12/12/2020 18:40	12/12/2020 23:19	4,65	256	1189,69	CHI
20201268784	GOIANIA	13659042	ATLANTICO S2	12/12/2020 18:40	12/12/2020 22:12	12/12/2020 18:40	12/12/2020 22:12	3,53	1	3,53	CHI
20201268785	CALDAS NOVAS	760443932	CALDAS NOVAS S2	12/12/2020 18:40	13/12/2020 10:11	12/12/2020 18:40	13/12/2020 10:11	15,50	1	15,50	CHI
20201268786	MAIRIPOTABA	MI10408274	PONTALINA	12/12/2020 18:40	13/12/2020 07:42	12/12/2020 18:40	13/12/2020 07:42	13,03	4	52,13	CHI
20201268786	PIRACANJUBA	MI10408274	PONTALINA	12/12/2020 18:40	13/12/2020 07:42	13/12/2020 18:40	13/12/2020 07:42	13,03	1	13,03	CHI
20201268786	PROFESSOR JAMIL SAFADY	MI10408274	PONTALINA	12/12/2020 18:40	13/12/2020 07:42	12/12/2020 18:40	13/12/2020 07:42	13,03	7	91,22	CHI
20201267269	CAVALCANTE	CJ11212410	MINACU	12/12/2020 18:42	13/12/2020 13:22	12/12/2020 18:42	13/12/2020 13:22	18,66	40	746,41	CHI
20201268809	ARAGUAPAZ	1780022247	GOIAS	12/12/2020 18:44	13/12/2020 16:25	12/12/2020 18:44	13/12/2020 16:25	21,69	1	21,69	CHI
20201269361	MARA ROSA	MQ12380741	SANTA TEREZINHA	12/12/2020 18:44	13/12/2020 22:14	12/12/2020 18:44	13/12/2020 22:14	27,50	12	330,06	CHI
20201268813	PLANALTINA	2960040229	PLANALTINA	12/12/2020 18:45	12/12/2020 20:53	12/12/2020 18:45	12/12/2020 20:53	2,13	1	2,13	CHI
20201268815	CAMPO LIMPO	AN12258236	NEROPOLIS S1	12/12/2020 18:45	13/12/2020 07:59	12/12/2020 18:45	13/12/2020 07:59	13,23	5	66,13	CHI
20201268816	PLANALTINA	2960119685	PLANALTINA	12/12/2020 18:45	12/12/2020 20:07	12/12/2020 18:45	12/12/2020 20:07	1,36	1	1,36	CHI
20201268819	HIDROLANDIA	HD31117893	CEPAIGO S2	12/12/2020 18:46	12/12/2020 22:01	12/12/2020 18:46	12/12/2020 22:01	3,24	1	3,24	CHI
20201268822	CRISTALINA	KR21163729	CRISTALINA S2	12/12/2020 18:46	13/12/2020 09:21	12/12/2020 18:46	13/12/2020 09:21	14,58	1	14,58	CHI
20201268922	CORUMBAIBA	NE12377067	CATALAO S1	12/12/2020 18:46	12/12/2020 21:35	12/12/2020 18:46	12/12/2020 21:35	2,81	15	42,16	CHI
20201268922	NOVA AURORA	NE12377067	CATALAO S1	12/12/2020 18:46	12/12/2020 21:35	12/12/2020 18:46	12/12/2020 21:35	2,81	10	28,11	CHI
20201268834	SANTO ANTONIO DE GOIAS	NR11246206	NEROPOLIS S2	12/12/2020 18:47	12/12/2020 19:51	12/12/2020 18:47	12/12/2020 19:51	1,06	27	28,70	CHI
20201268847	PADRE BERNARDO	PB12133190	PADRE BERNARDO	12/12/2020 18:49	12/12/2020 21:59	12/12/2020 18:49	12/12/2020 21:59	3,16	25	79,10	CHI
20201268849	GUARINOS	GF21147934	SANTA TEREZINHA	12/12/2020 18:49	13/12/2020 09:21	12/12/2020 18:49	13/12/2020 09:21	14,53	1	14,53	CHI
20201268853	MONTE ALEGRE DE GOIAS	MA12217827	SAO DOMINGOS	12/12/2020 18:49	13/12/2020 14:46	12/12/2020 18:49	13/12/2020 04:15	9,43	3	28,30	CHI
20201268853	MONTE ALEGRE DE GOIAS	MA12217827	SAO DOMINGOS	12/12/2020 18:49	13/12/2020 14:46	12/12/2020 18:49	13/12/2020 09:48	14,97	2	29,95	CHI
20201268853	MONTE ALEGRE DE GOIAS	MA12217827	SAO DOMINGOS	12/12/2020 18:49	13/12/2020 14:46	12/12/2020 18:49	13/12/2020 13:33	18,72	6	112,34	CHI
20201268853	MONTE ALEGRE DE GOIAS	MA12217827	SAO DOMINGOS	12/12/2020 18:49	13/12/2020 14:46	12/12/2020 18:49	13/12/2020 14:10	19,34	4	77,38	CHI
20201268853	MONTE ALEGRE DE GOIAS	MA12217827	SAO DOMINGOS	12/12/2020 18:49	13/12/2020 14:46	12/12/2020 18:49	13/12/2020 14:14	19,41	4	77,63	CHI
20201268853	MONTE ALEGRE DE GOIAS	MA12217827	SAO DOMINGOS	12/12/2020 18:49	13/12/2020 14:46	12/12/2020 18:49	13/12/2020 14:26	19,61	5	98,05	CHI
20201268853	MONTE ALEGRE DE GOIAS	MA12217827	SAO DOMINGOS	12/12/2020 18:49	13/12/2020 14:46	12/12/2020 18:49	13/12/2020 14:42	19,88	1	19,88	CHI
20201268853	MONTE ALEGRE DE GOIAS	MA12217827	SAO DOMINGOS	12/12/2020 18:49	13/12/2020 14:46	12/12/2020 18:49	13/12/2020 14:46	19,94	3	59,81	CHI
20201269124	JATAI	JT12165942	JATAI S2	12/12/2020 18:49	12/12/2020 19:46	12/12/2020 18:49	12/12/2020 19:46	0,94	462	432,48	CHI
20201268859	LUZIANIA	120117046	RIO VERMELHO	12/12/2020 18:50	12/12/2020 20:56	12/12/2020 18:50	12/12/2020 20:56	2,09	1	2,09	CHI
20201268860	BURITI ALEGRE	BG21120889	ITUMBIARA VELHA S2	12/12/2020 18:51	13/12/2020 09:53	12/12/2020 18:51	13/12/2020 09:53	15,03	1	15,03	CHI
20201269007	GOIAS	GS12203896	ITABERAI S2	12/12/2020 18:51	13/12/2020 02:07	12/12/2020 18:51	13/12/2020 02:07	7,26	40	290,37	CHI
20201268869	VILA PROPICIO	PV12115145	GOIANESIA S1	12/12/2020 18:52	13/12/2020 22:20	12/12/2020 18:52	13/12/2020 22:20	27,47	5	137,33	CHI
20201268871	GOIANIA	16392668	GOYA S2	12/12/2020 18:52	12/12/2020 21:56	12/12/2020 18:52	12/12/2020 21:56	3,06	1	3,06	CHI
20201268876	MUTUNOPOLIS	MU21262529	MARA ROSA	12/12/2020 18:52	13/12/2020 00:48	12/12/2020 18:52	13/12/2020 00:48	5,92	1	5,92	CHI
20201268877	SAO JOAO DA PARAUNA	PU21228080	FIRMINOPOLIS S2	12/12/2020 18:52	13/12/2020 00:52	12/12/2020 18:52	13/12/2020 00:52	5,99	1	5,99	CHI
20201269207	GUARAITA	IK12310872	ITAPURANGA	12/12/2020 18:52	13/12/2020 12:01	12/12/2020 18:52	13/12/2020 12:01	17,14	4	68,57	CHI
20201269207	ITAPURANGA	IK12310872	ITAPURANGA	12/12/2020 18:52	13/12/2020 12:01	12/12/2020 18:52	13/12/2020 12:01	17,14	2	34,29	CHI
20201272197	JANDAIA	1180016900	PALMEIRAS	12/12/2020 18:52	13/12/2020 16:13	12/12/2020 18:52	13/12/2020 16:13	21,35	1	21,35	CHI

20201269525	CORUMBAIBA	CI12377066	CATALAO S1	12/12/2020 18:53	13/12/2020 11:06	12/12/2020 18:53	13/12/2020 11:06	16,21	6	97,27	CHI
20201268895	GOIANIA	GN11273549	GOYA S1	12/12/2020 18:55	13/12/2020 00:39	12/12/2020 18:55	13/12/2020 00:39	5,72	37	211,74	CHI
20201268897	FORMOSA	FA21218390	ITUIQUIRA	12/12/2020 18:55	12/12/2020 21:07	12/12/2020 18:55	12/12/2020 21:07	2,19	1	2,19	CHI
20201268901	QUIRINOPOLIS	QI32050233	QUIRINOPOLIS	12/12/2020 18:56	13/12/2020 00:01	12/12/2020 18:56	13/12/2020 00:01	5,08	7	35,54	CHI
20201268904	GOIANIA	10052641	CAMPINAS S2	12/12/2020 18:56	13/12/2020 02:53	12/12/2020 18:56	13/12/2020 02:53	7,94	1	7,94	CHI
20201268906	ARAGARCAS	AG12072885	ARAGARCAS	12/12/2020 18:56	12/12/2020 23:54	12/12/2020 18:56	12/12/2020 23:54	4,95	6	29,71	CHI
20201268907	PETROLINA DE GOIAS	320038920	PETROLINA	12/12/2020 18:57	14/12/2020 14:10	12/12/2020 18:57	14/12/2020 14:10	43,23	1	43,23	CHI
20201268908	VILA PROPICIO	NP12255982	GOIANESIA S1	12/12/2020 18:57	13/12/2020 18:16	12/12/2020 18:57	13/12/2020 18:16	23,33	8	186,64	CHI
20201268908	PIRENOPOLIS	NP12255982	GOIANESIA S1	12/12/2020 18:57	13/12/2020 18:16	12/12/2020 18:57	13/12/2020 18:16	23,33	1	23,33	CHI
20201268910	GOIANIA	10008812711	MEIA PONTE	12/12/2020 18:57	12/12/2020 23:11	12/12/2020 18:57	12/12/2020 23:11	4,23	1	4,23	CHI
20201268913	NAZARIO	10019584090	ANICUNS	12/12/2020 18:57	13/12/2020 09:03	12/12/2020 18:57	13/12/2020 09:03	14,09	1	14,09	CHI
20201268917	LUZIANIA	LZ21156991	CRISTALINA S2	12/12/2020 18:58	12/12/2020 23:51	12/12/2020 18:58	12/12/2020 23:51	4,87	2	9,75	CHI
20201269514	MORRINHOS	MR12389873	MORRINHOS	12/12/2020 19:00	12/12/2020 23:46	12/12/2020 19:00	12/12/2020 23:46	4,77	39	185,86	CHI
20201269652	QUIRINOPOLIS	QI12226698	SANTA HELENA S1	12/12/2020 19:00	13/12/2020 00:21	12/12/2020 19:00	13/12/2020 00:21	5,34	6	32,07	CHI
20201268944	CIDADE OCIDENTAL	2680053352	MARAJOARA	12/12/2020 19:02	12/12/2020 23:21	12/12/2020 19:02	12/12/2020 23:21	4,30	1	4,30	CHI
20201268994	GUAPO	GA11275651	GUAPO S1	12/12/2020 19:04	12/12/2020 22:38	12/12/2020 19:04	12/12/2020 22:38	3,55	178	632,10	CHI
20201269045	RIO VERDE	RV12260643	CABRIUVA S2	12/12/2020 19:04	12/12/2020 23:49	12/12/2020 19:04	12/12/2020 23:49	4,74	9	42,70	CHI
20201269205	CEZARINA	VJ32050035	GUAPO S2	12/12/2020 19:04	13/12/2020 09:25	12/12/2020 19:04	13/12/2020 09:25	14,35	11	157,83	CHI
20201269205	VARJAO	VJ32050035	GUAPO S2	12/12/2020 19:04	13/12/2020 09:25	12/12/2020 19:04	13/12/2020 09:25	14,35	9	129,13	CHI
20201268961	APARECIDA DE GOIANIA	200522991	ANHANGUERA	12/12/2020 19:05	12/12/2020 22:01	12/12/2020 19:05	12/12/2020 22:01	2,93	1	2,93	CHI
20201268973	VILA BOA	FA12042058	ITUIQUIRA	12/12/2020 19:05	13/12/2020 10:59	12/12/2020 19:05	13/12/2020 10:59	15,88	2	31,77	CHI
20201269816	CACHOEIRA DE GOIAS	CG12391526	FIRMINOPOLIS S2	12/12/2020 19:05	13/12/2020 07:13	12/12/2020 19:05	13/12/2020 07:13	12,12	11	133,34	CHI
20201269816	PARAUANDA	CG12391526	FIRMINOPOLIS S2	12/12/2020 19:05	13/12/2020 07:13	12/12/2020 19:05	13/12/2020 07:13	12,12	32	387,89	CHI
20201269816	AURILANDIA	CG12391526	FIRMINOPOLIS S2	12/12/2020 19:05	13/12/2020 07:13	12/12/2020 19:05	13/12/2020 07:13	12,12	2	24,24	CHI
20201268978	SAO MIGUEL DO ARAGUAIA	4650002292	SAO MIGUEL DO ARAGUAIA	12/12/2020 19:07	13/12/2020 21:58	12/12/2020 19:07	13/12/2020 21:58	26,85	1	26,85	CHI
20201269004	ITABERAI	IB21336382	ITABERAI S1	12/12/2020 19:08	13/12/2020 11:50	12/12/2020 19:08	13/12/2020 11:46	16,64	10	166,38	CHI
20201269004	ITABERAI	IB21311169	ITABERAI S1	12/12/2020 19:08	13/12/2020 11:50	12/12/2020 19:08	13/12/2020 11:50	16,70	2	33,40	CHI
20201269072	GOIANIA	GN12004098	FERROVIARIO S3	12/12/2020 19:08	12/12/2020 21:02	12/12/2020 19:08	12/12/2020 21:02	1,89	1031	1944,01	CHI
20201268990	EDEIA	ED12096861	EDEIA	12/12/2020 19:09	12/12/2020 21:44	12/12/2020 19:09	12/12/2020 21:44	2,58	2	5,16	CHI
20201269000	FORMOSA	10009744116	ITUIQUIRA	12/12/2020 19:09	13/12/2020 04:44	12/12/2020 19:09	13/12/2020 04:44	9,57	1	9,57	CHI
20201269006	GOIANIA	16601798	GOIANIA LESTE S2	12/12/2020 19:10	12/12/2020 21:38	12/12/2020 19:10	12/12/2020 21:38	2,47	1	2,47	CHI
20201269008	EDEIA	1120021719	EDEIA	12/12/2020 19:10	12/12/2020 21:32	12/12/2020 19:10	12/12/2020 21:32	2,36	1	2,36	CHI
20201269015	MINEIROS	MY21195603	PARQUE DAS EMAS	12/12/2020 19:11	13/12/2020 03:54	12/12/2020 19:11	13/12/2020 03:54	8,71	1	8,71	CHI
20201269016	GOIANIA	10004930876	MEIA PONTE	12/12/2020 19:11	12/12/2020 23:11	12/12/2020 19:11	12/12/2020 23:11	3,99	1	3,99	CHI
20201269023	PONTALINA	PK11000007	PONTALINA	12/12/2020 19:12	12/12/2020 20:22	12/12/2020 19:12	12/12/2020 20:22	1,17	71	82,79	CHI
20201269027	RIO VERDE	630558050	RIO VERDE S2	12/12/2020 19:12	12/12/2020 21:27	12/12/2020 19:12	12/12/2020 21:27	2,24	1	2,24	CHI
20201269042	SANTA CRUZ DE GOIAS	BC21124195	PIRES DO RIO S2	12/12/2020 19:13	12/12/2020 23:00	12/12/2020 19:13	12/12/2020 23:00	3,77	1	3,77	CHI
20201269060	ANICUNS	AC12259103	FIRMINOPOLIS S2	12/12/2020 19:13	13/12/2020 03:01	12/12/2020 19:13	13/12/2020 03:01	7,79	19	148,07	CHI
20201269470	CORUMBAIBA	CI12377073	CATALAO S1	12/12/2020 19:13	12/12/2020 22:26	12/12/2020 19:13	12/12/2020 22:26	3,21	6	19,27	CHI
20201269470	NOVA AURORA	CI12377073	CATALAO S1	12/12/2020 19:13	12/12/2020 22:26	12/12/2020 19:13	12/12/2020 22:26	3,21	8	25,70	CHI
20201269055	AGUAS LINDAS DE GOIAS	10024509270	AGUAS LINDAS DE GOIAS S1	12/12/2020 19:14	12/12/2020 21:46	12/12/2020 19:14	12/12/2020 21:46	2,52	1	2,52	CHI
20201269057	JATAI	JT12303837	JATAI S1	12/12/2020 19:15	12/12/2020 21:49	12/12/2020 19:15	12/12/2020 21:49	2,56	26	66,60	CHI
20201269059	ITUMBIARA	IT11290350	ITUMBIARA VELHA S2	12/12/2020 19:15	13/12/2020 17:16	12/12/2020 19:15	13/12/2020 17:16	22,01	1	22,01	CHI
20201269061	CEZARINA	CZ21323469	GUAPO S2	12/12/2020 19:16	13/12/2020 15:17	12/12/2020 19:16	13/12/2020 15:17	20,01	1	20,01	CHI
20201269064	SANTO ANTONIO DO DESCOBERTO	SN21234944	AGUAS LINDAS DE GOIAS S2	12/12/2020 19:17	13/12/2020 09:57	12/12/2020 19:17	13/12/2020 09:57	14,66	2	29,33	CHI
20201269073	JATAI	JT1340030	JATAI S1	12/12/2020 19:18	12/12/2020 22:16	12/12/2020 19:18	12/12/2020 22:16	2,96	1	2,96	CHI
20201268118	PORANGATU	10029891351	PORANGATU	12/12/2020 19:19	12/12/2020 20:54	12/12/2020 19:19	12/12/2020 20:54	1,58	1	1,58	CHI
20201269075	FAINA	FC12219921	GOIAS	12/12/2020 19:19	13/12/2020 08:40	12/12/2020 19:19	13/12/2020 08:40	13,35	4	53,38	CHI
20201269081	PILAR DE GOIAS	GG21168847	SANTA TEREZINHA	12/12/2020 19:19	13/12/2020 19:17	12/12/2020 19:19	13/12/2020 19:17	23,95	1	23,95	CHI
20201269083	RIO VERDE	10022094154	RIO VERDE S1	12/12/2020 19:20	13/12/2020 02:01	12/12/2020 19:20	13/12/2020 02:01	6,67	1	6,67	CHI
20201269555	SANTO ANTONIO DE GOIAS	BW11145993	NEROPOLIS S1	12/12/2020 19:20	12/12/2020 22:52	12/12/2020 19:20	12/12/2020 22:52	3,52	138	485,57	CHI

20201269104	JUSSARA	JR21013112	BRITANIA	12/12/2020 19:24	13/12/2020 14:15	12/12/2020 19:24	13/12/2020 14:15	18,84	2	37,68	CHI
20201269195	INACIOLANDIA	ID12359397LD	QUIRINOPOLIS	12/12/2020 19:27	12/12/2020 20:53	12/12/2020 19:27	12/12/2020 20:53	1,42	57	80,81	CHI
20201269195	ITUMBIARA	ID12359397LD	QUIRINOPOLIS	12/12/2020 19:27	12/12/2020 20:53	12/12/2020 19:27	12/12/2020 20:53	1,42	3	4,25	CHI
20201269126	MINACU	IH21268724	MINACU	12/12/2020 19:29	13/12/2020 03:14	12/12/2020 19:29	13/12/2020 03:14	7,75	1	7,75	CHI
20201269129	PIRACANJUBA	PJ21000043	CALDAS NOVAS S1	12/12/2020 19:29	13/12/2020 09:45	12/12/2020 19:29	13/12/2020 09:45	14,25	1	14,25	CHI
20201269132	SANTO ANTONIO DO DESCOBERTO	SN12382973	MARAJOARA	12/12/2020 19:30	13/12/2020 10:59	12/12/2020 19:30	13/12/2020 10:59	15,48	5	77,41	CHI
20201269136	APARECIDA DE GOIANIA	13942153	INDEPENDENCIA S2	12/12/2020 19:31	12/12/2020 21:23	12/12/2020 19:31	12/12/2020 21:23	1,86	1	1,86	CHI
20201269137	MINEIROS	MY12156849	PARQUE DAS EMAS	12/12/2020 19:31	13/12/2020 12:32	12/12/2020 19:31	13/12/2020 12:32	17,01	11	187,13	CHI
20201269138	GOIANIA	13362124	REAL S1	12/12/2020 19:31	12/12/2020 22:33	12/12/2020 19:31	12/12/2020 22:33	3,03	1	3,03	CHI
20201269141	SILVANIA	SV12389456	VIANOPOLIS	12/12/2020 19:31	12/12/2020 23:01	12/12/2020 19:31	12/12/2020 23:01	3,49	110	383,53	CHI
20201269161	GOIATUBA	GT32048521	GOIATUBA S2	12/12/2020 19:33	13/12/2020 09:39	12/12/2020 19:33	13/12/2020 09:39	14,09	8	112,69	CHI
20201269177	OUVIDOR	OU21308654	CATALAO S1	12/12/2020 19:38	12/12/2020 21:28	12/12/2020 19:38	12/12/2020 21:28	1,83	3	5,50	CHI
20201269231	SANTO ANTONIO DO DESCOBERTO	SN12275322	MARAJOARA	12/12/2020 19:38	13/12/2020 05:22	12/12/2020 19:38	13/12/2020 05:22	9,74	6	58,42	CHI
20201269257	PONTALINA	PK12109412	PONTALINA	12/12/2020 19:38	12/12/2020 21:07	12/12/2020 19:38	12/12/2020 21:07	1,48	14	20,67	CHI
20201269187	CAIAPONIA	CP12374863	CAIAPONIA	12/12/2020 19:40	13/12/2020 08:51	12/12/2020 19:40	13/12/2020 08:51	13,17	2	26,35	CHI
20201269190	JATAI	290236083	JATAI S3	12/12/2020 19:40	12/12/2020 21:41	12/12/2020 19:40	12/12/2020 21:41	2,00	1	2,00	CHI
20201269192	GOIANIA	10684347	ATLANTICO S2	12/12/2020 19:41	12/12/2020 22:20	12/12/2020 19:41	12/12/2020 22:20	2,65	1	2,65	CHI
20201269201	AGUA FRIA DE GOIAS	PI21062249	SAO JOAO D ALIANCA	12/12/2020 19:43	13/12/2020 08:05	12/12/2020 19:43	13/12/2020 08:05	12,36	2	24,71	CHI
20201269211	MORRINHOS	MR11329030	MORRINHOS	12/12/2020 19:44	12/12/2020 21:13	12/12/2020 19:44	12/12/2020 21:13	1,48	61	90,42	CHI
20201269212	PLANALTINA	10010549844	PLANALTINA	12/12/2020 19:45	12/12/2020 21:12	12/12/2020 19:45	12/12/2020 21:12	1,44	1	1,44	CHI
20201269228	SILVANIA	SV12205367	VIANOPOLIS	12/12/2020 19:45	13/12/2020 00:02	12/12/2020 19:45	13/12/2020 00:02	4,27	15	64,04	CHI
20201269215	VALPARAISO DE GOIAS	2860291368	PACAEMBU S2	12/12/2020 19:46	12/12/2020 21:45	12/12/2020 19:46	12/12/2020 21:45	1,98	1	1,98	CHI
20201269218	CROMINIA	CQ12293027	PONTALINA	12/12/2020 19:47	12/12/2020 22:42	12/12/2020 19:47	12/12/2020 22:42	2,91	13	37,78	CHI
20201269229	IPAMERI	IP12215692	PIRES DO RIO S2	12/12/2020 19:48	13/12/2020 21:51	12/12/2020 19:48	13/12/2020 21:51	26,03	2	52,07	CHI
20201269357	ITABERAI	IB12300330	ITABERAI S2	12/12/2020 19:48	12/12/2020 23:22	12/12/2020 19:48	12/12/2020 23:22	3,56	14	49,89	CHI
20201269243	MORRINHOS	MR12212692	MORRINHOS	12/12/2020 19:51	12/12/2020 22:05	12/12/2020 19:51	12/12/2020 22:05	2,22	28	62,19	CHI
20201271742	IPAMERI	6930000330	PIRES DO RIO S2	12/12/2020 19:51	13/12/2020 22:28	12/12/2020 19:51	13/12/2020 22:28	26,61	1	26,61	CHI
20201269251	PONTALINA	PK12080022	PONTALINA	12/12/2020 19:52	12/12/2020 23:41	12/12/2020 19:52	12/12/2020 23:41	3,80	5	19,01	CHI
20201269253	FORMOSA	FA11268093	ITUIQUIRA	12/12/2020 19:53	13/12/2020 03:15	12/12/2020 19:53	13/12/2020 03:15	7,36	136	1001,26	CHI
20201269258	BELA VISTA DE GOIAS	240046985	BELA VISTA S2	12/12/2020 19:54	12/12/2020 21:50	12/12/2020 19:54	12/12/2020 21:50	1,93	1	1,93	CHI
20201269825	SAO MIGUEL DO PASSA QUATRO	SQ12111663	CRISTIANOPOLIS	12/12/2020 19:54	13/12/2020 03:31	12/12/2020 19:54	13/12/2020 03:31	7,60	14	106,47	CHI
20201269268	CAIAPONIA	RV12030683	MONTIVIDIU T	12/12/2020 19:55	12/12/2020 22:44	12/12/2020 19:55	12/12/2020 22:44	2,80	212	594,48	CHI
20201269268	RIO VERDE	RV12030683	MONTIVIDIU T	12/12/2020 19:55	12/12/2020 22:44	12/12/2020 19:55	12/12/2020 22:44	2,80	3	8,41	CHI
20201269269	GOIANIA	16923832	CAMPINAS S2	12/12/2020 19:55	12/12/2020 23:17	12/12/2020 19:55	12/12/2020 23:17	3,35	1	3,35	CHI
20201269271	ACREUNA	2440042001	ACREUNA	12/12/2020 19:56	12/12/2020 22:51	12/12/2020 19:56	12/12/2020 22:51	2,91	1	2,91	CHI
20201269594	SERRANOPOLIS	SX21244267	JATAI S1	12/12/2020 19:56	13/12/2020 11:50	12/12/2020 19:56	13/12/2020 11:50	15,90	1	15,90	CHI
20201269275	BRITANIA	BT12210256	BRITANIA	12/12/2020 19:57	13/12/2020 20:51	12/12/2020 19:57	13/12/2020 20:51	24,90	10	248,96	CHI
20201269278	CABECEIRAS	CW21180634	ITUIQUIRA	12/12/2020 19:58	12/12/2020 22:25	12/12/2020 19:58	12/12/2020 22:25	2,44	1	2,44	CHI
20201269292	ACREUNA	2440033139	ACREUNA	12/12/2020 20:00	13/12/2020 01:02	12/12/2020 20:00	13/12/2020 01:02	5,02	1	5,02	CHI
20201269308	CATALAO	1990142634	CATALAO S2	12/12/2020 20:04	12/12/2020 22:58	12/12/2020 20:04	12/12/2020 22:58	2,90	1	2,90	CHI
20201269312	TRINDADE	TR12036568	TRINDADE	12/12/2020 20:05	12/12/2020 21:23	12/12/2020 20:05	12/12/2020 21:23	1,29	7	9,04	CHI
20201269318	ALEXANIA	SN12330532	MARAJOARA	12/12/2020 20:07	13/12/2020 08:59	12/12/2020 20:07	13/12/2020 08:59	12,87	4	51,47	CHI
20201269318	SANTO ANTONIO DO DESCOBERTO	SN12330532	MARAJOARA	12/12/2020 20:07	13/12/2020 08:59	12/12/2020 20:07	13/12/2020 08:59	12,87	31	398,86	CHI
20201269319	HIDROLANDIA	10029130970	CEPAIGO S1	12/12/2020 20:07	12/12/2020 21:48	12/12/2020 20:07	12/12/2020 21:48	1,67	1	1,67	CHI
20201269344	BELA VISTA DE GOIAS	BV32021549	BELA VISTA S1	12/12/2020 20:10	12/12/2020 23:02	12/12/2020 20:10	12/12/2020 23:02	2,85	10	28,55	CHI
20201269350	ITUMBIARA	IT121333091	BOM JESUS DE GOIAS	12/12/2020 20:12	13/12/2020 13:26	12/12/2020 20:12	13/12/2020 13:26	17,23	1	17,23	CHI
20201269365	NOVA AURORA	NE21042377	CATALAO S1	12/12/2020 20:16	12/12/2020 23:55	12/12/2020 20:16	12/12/2020 23:55	3,64	1	3,64	CHI
20201269366	MINEIROS	1390022460	PARQUE DAS EMAS	12/12/2020 20:16	13/12/2020 08:26	12/12/2020 20:16	13/12/2020 08:26	12,17	1	12,17	CHI
20201269374	PIRES DO RIO	PR21154622	PIRES DO RIO S1	12/12/2020 20:18	13/12/2020 18:35	12/12/2020 20:18	13/12/2020 18:35	22,28	1	22,28	CHI
20201269377	MORRINHOS	MR21284230	MORRINHOS	12/12/2020 20:19	13/12/2020 09:42	12/12/2020 20:19	13/12/2020 09:42	13,38	1	13,38	CHI
20201269379	BOM JESUS DE GOIAS	BJ21000337	BOM JESUS DE GOIAS	12/12/2020 20:19	13/12/2020 16:56	12/12/2020 20:19	13/12/2020 16:56	20,61	1	20,61	CHI

20201269381	LUZIANIA	LZ11219585	MARAJOARA	12/12/2020 20:19	12/12/2020 21:29	12/12/2020 20:19	12/12/2020 21:29	1,15	182	209,55	CHI
20201269408	GOIANIA	GN11197027	XAVANTES	12/12/2020 20:20	12/12/2020 23:54	12/12/2020 20:20	12/12/2020 23:54	3,56	44	156,84	CHI
20201269396	GOIANIA	GN11001093	CAMPINAS S1	12/12/2020 20:24	13/12/2020 00:42	12/12/2020 20:24	13/12/2020 00:42	4,30	105	451,27	CHI
20201269405	LUZIANIA	LZ12070127RE	MARAJOARA	12/12/2020 20:26	12/12/2020 23:20	12/12/2020 20:26	12/12/2020 23:20	2,89	17	49,17	CHI
20201269423	MORRINHOS	MR12039380	MORRINHOS	12/12/2020 20:35	13/12/2020 00:39	12/12/2020 20:35	13/12/2020 00:39	4,06	12	48,74	CHI
20201269429	QUIRINOPOLIS	QI21279625	QUIRINOPOLIS	12/12/2020 20:36	13/12/2020 03:01	12/12/2020 20:36	13/12/2020 03:01	6,40	2	12,80	CHI
20201269432	APARECIDA DE GOIANIA	200115467	INDEPENDENCIA S2	12/12/2020 20:39	12/12/2020 22:28	12/12/2020 20:39	12/12/2020 22:28	1,81	1	1,81	CHI
20201269434	VIANOPOLIS	VN21275128	PIRES DO RIO S2	12/12/2020 20:40	13/12/2020 02:12	12/12/2020 20:40	13/12/2020 02:12	5,53	1	5,53	CHI
20201269436	PADRE BERNARDO	PB12052000	PADRE BERNARDO	12/12/2020 20:41	13/12/2020 10:21	12/12/2020 20:41	13/12/2020 10:21	13,66	4	54,66	CHI
20201269688	CALDAS NOVAS	MG12120777	VILA CORUMBA	12/12/2020 20:42	13/12/2020 11:47	12/12/2020 20:42	13/12/2020 11:47	15,07	0	0,00	CHI
20201269688	RIO QUENTE	MG12120777	VILA CORUMBA	12/12/2020 20:42	13/12/2020 11:47	12/12/2020 20:42	13/12/2020 11:47	15,07	1	15,07	CHI
20201269688	MARZAGAO	MG12120777	VILA CORUMBA	12/12/2020 20:42	13/12/2020 11:47	12/12/2020 20:42	13/12/2020 11:47	15,07	2	30,15	CHI
20201269995	GOIATUBA	GT12296905	GOIATUBA S2	12/12/2020 20:43	13/12/2020 08:04	12/12/2020 20:43	13/12/2020 08:04	11,34	7	79,39	CHI
20201269700	RIO VERDE	RV11279559	RIO VERDE S1	12/12/2020 20:48	12/12/2020 23:49	12/12/2020 20:48	12/12/2020 23:49	3,01	120	361,43	CHI
20201269467	CUMARI	CY12281463	CATALAO S1	12/12/2020 20:50	13/12/2020 05:29	12/12/2020 20:50	13/12/2020 05:29	8,65	4	34,59	CHI
20201269469	DAVINOPOLIS	IO12037555	CATALAO S1	12/12/2020 20:50	13/12/2020 00:01	12/12/2020 20:50	13/12/2020 00:01	3,18	17	54,03	CHI
20201269469	DISTRITO FEDERAL	IO12037555	CATALAO S1	12/12/2020 20:50	13/12/2020 00:01	12/12/2020 20:50	13/12/2020 00:01	3,18	2	6,36	CHI
20201269476	BOM JESUS DE GOIAS	BJ12222283	RIO DOS BOIS	12/12/2020 20:51	13/12/2020 10:44	12/12/2020 20:51	13/12/2020 10:44	13,88	2	27,75	CHI
20201269480	GOIANIA	15925699	GOYA S2	12/12/2020 20:52	13/12/2020 01:48	12/12/2020 20:52	13/12/2020 01:48	4,92	1	4,92	CHI
20201269491	IPAMERI	IP12114042	IPAMERI	12/12/2020 20:56	13/12/2020 00:08	12/12/2020 20:56	13/12/2020 00:08	3,20	3	9,59	CHI
20201269495	ITAUCU	IX21317410	INHUMAS S1	12/12/2020 20:58	12/12/2020 23:10	12/12/2020 20:58	12/12/2020 23:10	2,20	2	4,39	CHI
20201269499	MORRINHOS	MR12093241	MORRINHOS	12/12/2020 20:58	13/12/2020 08:35	12/12/2020 20:58	13/12/2020 08:35	11,60	7	81,20	CHI
20201269499	IPAMERI	MR12093241	MORRINHOS	12/12/2020 20:58	13/12/2020 08:35	12/12/2020 20:58	13/12/2020 08:35	11,60	1	11,60	CHI
20201269563	TRES RANCHOS	OU12064037	CATALAO S1	12/12/2020 21:18	13/12/2020 02:54	12/12/2020 21:18	13/12/2020 02:54	5,60	4	22,39	CHI
20201269563	OUVIDOR	OU12064037	CATALAO S1	12/12/2020 21:18	13/12/2020 02:54	12/12/2020 21:18	13/12/2020 02:54	5,60	6	33,59	CHI
20201269646	DAVINOPOLIS	IO12266776	CATALAO S1	12/12/2020 21:18	13/12/2020 01:39	12/12/2020 21:18	13/12/2020 01:39	4,35	4	17,40	CHI
20201269565	CACHOEIRA DOURADA	130015714	CACHOEIRA DOURADA	12/12/2020 21:19	13/12/2020 18:25	12/12/2020 21:19	13/12/2020 18:25	21,10	1	21,10	CHI
20201269655	EDEIA	EA12223550RE	EDEIA	12/12/2020 21:45	13/12/2020 08:11	12/12/2020 21:45	13/12/2020 08:11	10,43	25	260,77	CHI
20201269655	INDIARA	EA12223550RE	EDEIA	12/12/2020 21:45	13/12/2020 08:11	12/12/2020 21:45	13/12/2020 08:11	10,43	7	73,02	CHI
20201269655	EDEALINA	EA12223550RE	EDEIA	12/12/2020 21:45	13/12/2020 08:11	12/12/2020 21:45	13/12/2020 08:11	10,43	52	542,40	CHI
20201269660	OUVIDOR	OU12063780	CATALAO S1	12/12/2020 21:51	13/12/2020 01:11	12/12/2020 21:51	13/12/2020 01:11	3,34	2	6,68	CHI
20201269690	LUZIANIA	LZ12119965	PACAEMBU S2	12/12/2020 21:51	13/12/2020 02:00	12/12/2020 21:51	13/12/2020 02:00	4,15	17	70,54	CHI
20201269743	MAIRIPOTABA	MI21100197	PONTALINA	12/12/2020 22:12	13/12/2020 07:29	12/12/2020 22:12	13/12/2020 07:29	9,28	1	9,28	CHI
20201269800	CALDAS NOVAS	CN21120740	CALDAS NOVAS S1	12/12/2020 22:45	13/12/2020 08:54	12/12/2020 22:45	13/12/2020 08:54	10,15	1	10,15	CHI
20201270898	PIRES DO RIO	PR12404788	PIRES DO RIO S1	12/12/2020 23:03	13/12/2020 10:48	12/12/2020 23:03	13/12/2020 10:48	11,74	6	70,42	CHI
20201269844	ORIZONA	O1480414	PIRES DO RIO S2	12/12/2020 23:09	13/12/2020 04:03	12/12/2020 23:09	13/12/2020 00:46	1,63	8	13,03	CHI
20201269844	PIRES DO RIO	O1480414	PIRES DO RIO S2	12/12/2020 23:09	13/12/2020 04:03	12/12/2020 23:09	13/12/2020 00:46	1,63	9	14,65	CHI
20201269844	URUTAI	O1480414	PIRES DO RIO S2	12/12/2020 23:09	13/12/2020 04:03	12/12/2020 23:09	13/12/2020 00:46	1,63	97	157,95	CHI
20201269844	PIRES DO RIO	O1480414	PIRES DO RIO S2	12/12/2020 23:09	13/12/2020 04:03	12/12/2020 23:11	13/12/2020 00:46	1,59	1	1,59	CHI
20201269844	URUTAI	O1480414	PIRES DO RIO S2	12/12/2020 23:09	13/12/2020 04:03	12/12/2020 23:09	13/12/2020 02:56	3,80	6	22,78	CHI
20201269844	IPAMERI	O1480414	PIRES DO RIO S2	12/12/2020 23:09	13/12/2020 04:03	12/12/2020 23:09	13/12/2020 04:03	4,90	26	127,46	CHI
20201269844	ORIZONA	O1480414	PIRES DO RIO S2	12/12/2020 23:09	13/12/2020 04:03	12/12/2020 23:09	13/12/2020 04:03	4,90	1	4,90	CHI
20201269844	IPAMERI	UT13337237	PIRES DO RIO S2	12/12/2020 23:09	13/12/2020 04:03	12/12/2020 23:11	13/12/2020 04:03	4,86	1	4,86	CHI
20201270226	CALDAS NOVAS	CN12025381	SERRA DE CALDAS	12/12/2020 23:51	13/12/2020 10:37	12/12/2020 23:51	13/12/2020 10:37	10,76	10	107,60	CHI
20201270060	ORIZONA	OZ12084921RE	PIRES DO RIO S2	13/12/2020 02:55	13/12/2020 07:25	13/12/2020 02:55	13/12/2020 07:25	4,50	110	494,72	CHI
20201270060	VIANOPOLIS	OZ12084921RE	PIRES DO RIO S2	13/12/2020 02:55	13/12/2020 07:25	13/12/2020 02:55	13/12/2020 07:25	4,50	17	76,46	CHI
20201270540	CORUMBAIBA	CI12391490	VILA CORUMBA	13/12/2020 04:18	13/12/2020 10:06	13/12/2020 04:18	13/12/2020 10:06	5,79	37	214,37	CHI
20201270007	CORUMBAIBA	IP12404719	IPAMERI	13/12/2020 04:35	13/12/2020 07:59	13/12/2020 04:35	13/12/2020 07:59	3,39	16	54,31	CHI
20201270007	IPAMERI	IP12404719	IPAMERI	13/12/2020 04:35	13/12/2020 07:59	13/12/2020 04:35	13/12/2020 07:59	3,39	85	288,50	CHI
20201270007	NOVA AURORA	IP12404719	IPAMERI	13/12/2020 04:35	13/12/2020 07:59	13/12/2020 04:35	13/12/2020 07:59	3,39	2	6,79	CHI
20201270001	MORRINHOS	MR12121217	MORRINHOS	13/12/2020 04:55	13/12/2020 07:41	13/12/2020 04:55	13/12/2020 07:41	2,75	14	38,53	CHI

20201270422	ORIZONA	OZ12114505	PIRES DO RIO S2	13/12/2020 05:04	13/12/2020 19:27	13/12/2020 05:04	13/12/2020 19:27	14,37	20	287,39	CHI
20201270040	PONTALINA	PK12047065	PONTALINA	13/12/2020 05:29	13/12/2020 08:38	13/12/2020 05:29	13/12/2020 08:38	3,14	10	31,36	CHI
20201270170	MORRINHOS	MR12133255	MORRINHOS	13/12/2020 05:31	13/12/2020 09:12	13/12/2020 05:31	13/12/2020 09:12	3,67	12	44,08	CHI
20201271117	RIO QUENTE	RQ12100108	RIO QUENTE	13/12/2020 05:43	13/12/2020 10:39	13/12/2020 05:43	13/12/2020 10:39	4,93	8	39,43	CHI
20201270077	OUVIDOR	CT12266103	CATALAO S1	13/12/2020 05:49	13/12/2020 08:17	13/12/2020 05:49	13/12/2020 08:17	2,45	5	12,26	CHI
20201270077	CATALAO	CT12266103	CATALAO S1	13/12/2020 05:49	13/12/2020 08:17	13/12/2020 05:49	13/12/2020 08:17	2,45	2	4,90	CHI
20201270077	DAVINOPOLIS	CT12266103	CATALAO S1	13/12/2020 05:49	13/12/2020 08:17	13/12/2020 05:49	13/12/2020 08:17	2,45	44	107,85	CHI
20201270080	PONTALINA	PK21109381	PONTALINA	13/12/2020 05:52	13/12/2020 08:41	13/12/2020 05:52	13/12/2020 08:41	2,82	1	2,82	CHI
20201270081	GOIATUBA	VI12166490	VICENTINOPOLIS	13/12/2020 05:52	13/12/2020 07:57	13/12/2020 05:52	13/12/2020 07:57	2,08	4	8,31	CHI
20201270081	VICENTINOPOLIS	VI12166490	VICENTINOPOLIS	13/12/2020 05:52	13/12/2020 07:57	13/12/2020 05:52	13/12/2020 07:57	2,08	1	2,08	CHI
20201270106	EDEIA	EA12182708	EDEIA	13/12/2020 06:06	13/12/2020 08:38	13/12/2020 06:06	13/12/2020 08:38	2,53	3	7,58	CHI
20201270111	GOIATUBA	GT12247742	BOM JESUS DE GOIAS	13/12/2020 06:07	13/12/2020 11:26	13/12/2020 06:07	13/12/2020 11:26	5,30	7	37,11	CHI
20201270382	MAIRIPOTABA	MI12051347	PONTALINA	13/12/2020 06:07	13/12/2020 10:24	13/12/2020 06:07	13/12/2020 10:24	4,27	7	29,87	CHI
20201270382	PONTALINA	MI12051347	PONTALINA	13/12/2020 06:07	13/12/2020 10:24	13/12/2020 06:07	13/12/2020 10:24	4,27	3	12,80	CHI
20201270121	GOIANDIRA	GD12042358	CATALAO S1	13/12/2020 06:10	13/12/2020 09:38	13/12/2020 06:10	13/12/2020 09:38	3,45	10	34,51	CHI
20201270133	OUVIDOR	OU12000352	CATALAO S1	13/12/2020 06:13	13/12/2020 08:25	13/12/2020 06:13	13/12/2020 08:25	2,19	30	65,73	CHI
20201270133	TRES RANCHOS	OU12000352	CATALAO S1	13/12/2020 06:13	13/12/2020 08:25	13/12/2020 06:13	13/12/2020 08:25	2,19	8	17,53	CHI
20201270151	OUVIDOR	OU21377047	CATALAO S1	13/12/2020 06:20	13/12/2020 07:30	13/12/2020 06:20	13/12/2020 07:30	1,16	1	1,16	CHI
20201270166	ORIZONA	PR12404749	PIRES DO RIO S1	13/12/2020 06:26	13/12/2020 10:07	13/12/2020 06:26	13/12/2020 10:07	3,67	4	14,70	CHI
20201270166	PIRES DO RIO	PR12404749	PIRES DO RIO S1	13/12/2020 06:26	13/12/2020 10:07	13/12/2020 06:26	13/12/2020 10:07	3,67	13	47,77	CHI
20201270652	DAVINOPOLIS	IO12085152	CATALAO S1	13/12/2020 06:27	13/12/2020 14:45	13/12/2020 06:27	13/12/2020 08:57	2,49	1	2,49	CHI
20201270652	DAVINOPOLIS	IO12085152	CATALAO S1	13/12/2020 06:27	13/12/2020 14:45	13/12/2020 06:27	13/12/2020 14:45	8,29	7	58,00	CHI
20201270179	PIRACANJUBA	PJ12363983	CRISTIANOPOLIS	13/12/2020 06:29	13/12/2020 10:04	13/12/2020 06:29	13/12/2020 10:04	3,57	3	10,71	CHI
20201270342	EDEIA	EA12263391	EDEIA	13/12/2020 06:35	13/12/2020 09:44	13/12/2020 06:35	13/12/2020 09:44	3,14	21	65,87	CHI
20201270654	ORIZONA	OZ12038929	PIRES DO RIO S2	13/12/2020 06:37	13/12/2020 11:23	13/12/2020 06:37	13/12/2020 11:23	4,77	11	52,42	CHI
20201270221	MORRINHOS	MR12000287	MORRINHOS	13/12/2020 06:39	13/12/2020 12:37	13/12/2020 06:39	13/12/2020 12:37	5,96	2	11,91	CHI
20201270247	URUTAI	UT12417470	PIRES DO RIO S2	13/12/2020 06:45	13/12/2020 13:37	13/12/2020 06:45	13/12/2020 13:37	6,85	1	6,85	CHI
20201270396	ORIZONA	OZ12186210	PIRES DO RIO S2	13/12/2020 06:45	13/12/2020 09:44	13/12/2020 06:45	13/12/2020 09:44	2,97	22	65,29	CHI
20201270305	IPAMERI	IP12099279	PIRES DO RIO S2	13/12/2020 06:46	13/12/2020 19:01	13/12/2020 06:46	13/12/2020 19:01	12,24	2	24,47	CHI
20201270989	MORRINHOS	MR12182538	MORRINHOS	13/12/2020 06:46	13/12/2020 15:53	13/12/2020 06:46	13/12/2020 15:53	9,10	4	36,40	CHI
20201270905	SAO MIGUEL DO PASSA QUATRO	SQ12111663	CRISTIANOPOLIS	13/12/2020 06:55	13/12/2020 11:11	13/12/2020 06:55	13/12/2020 11:11	4,26	14	59,64	CHI
20201271247	DAVINOPOLIS	IO12037555	CATALAO S1	13/12/2020 06:56	13/12/2020 12:04	13/12/2020 06:56	13/12/2020 11:40	4,73	17	80,45	CHI
20201271247	DISTRITO FEDERAL	IO12037555	CATALAO S1	13/12/2020 06:56	13/12/2020 12:04	13/12/2020 06:56	13/12/2020 11:40	4,73	2	9,46	CHI
20201271247	DAVINOPOLIS	IO21270757	CATALAO S1	13/12/2020 06:56	13/12/2020 12:04	13/12/2020 11:49	13/12/2020 12:04	0,24	1	0,24	CHI
20201270313	MAIRIPOTABA	MI12057745	PONTALINA	13/12/2020 06:59	13/12/2020 09:12	13/12/2020 06:59	13/12/2020 09:12	2,21	9	19,91	CHI
20201270313	CROMINIA	MI12057745	PONTALINA	13/12/2020 06:59	13/12/2020 09:12	13/12/2020 06:59	13/12/2020 09:12	2,21	7	15,49	CHI
20201271005	INDIARA	IY12395106	EDEIA	13/12/2020 06:59	13/12/2020 10:25	13/12/2020 06:59	13/12/2020 10:25	3,43	284	973,09	CHI
20201270389	ORIZONA	OZ21036990	PIRES DO RIO S2	13/12/2020 07:16	13/12/2020 09:21	13/12/2020 07:16	13/12/2020 09:21	2,08	1	2,08	CHI
20201271432	MAIRIPOTABA	MI12293182	PONTALINA	13/12/2020 07:17	13/12/2020 12:41	13/12/2020 07:17	13/12/2020 12:41	5,40	8	43,18	CHI
20201271432	CEZARINA	MI12293182	PONTALINA	13/12/2020 07:17	13/12/2020 12:41	13/12/2020 07:17	13/12/2020 12:41	5,40	19	102,56	CHI
20201270950	BOM JESUS DE GOIAS	BJ12000040	BOM JESUS DE GOIAS	13/12/2020 07:23	13/12/2020 15:14	13/12/2020 07:23	13/12/2020 15:14	7,83	4	31,34	CHI
20201270496	OUVIDOR	OU21161370	CATALAO S1	13/12/2020 07:34	13/12/2020 10:07	13/12/2020 07:34	13/12/2020 10:07	2,54	1	2,54	CHI
20201270632	TRES RANCHOS	IO12085096	CATALAO S1	13/12/2020 07:38	13/12/2020 09:52	13/12/2020 07:38	13/12/2020 09:52	2,23	4	8,90	CHI
20201270632	DAVINOPOLIS	IO12085096	CATALAO S1	13/12/2020 07:38	13/12/2020 09:52	13/12/2020 07:38	13/12/2020 09:52	2,23	7	15,58	CHI
20201270632	OUVIDOR	IO12085096	CATALAO S1	13/12/2020 07:38	13/12/2020 09:52	13/12/2020 07:38	13/12/2020 09:52	2,23	2	4,45	CHI
20201270543	PIRACANJUBA	PJ12043108	PIRACANJUBA	13/12/2020 07:42	13/12/2020 11:29	13/12/2020 07:42	13/12/2020 11:29	3,77	12	45,22	CHI
20201270546	MAIRIPOTABA	PK12049523RE	PONTALINA	13/12/2020 07:43	13/12/2020 12:04	13/12/2020 07:43	13/12/2020 12:04	4,34	2	8,68	CHI
20201270546	PONTALINA	PK12049523RE	PONTALINA	13/12/2020 07:43	13/12/2020 12:04	13/12/2020 07:43	13/12/2020 12:04	4,34	11	47,73	CHI
20201270584	TRES RANCHOS	TH12057694	CATALAO S1	13/12/2020 07:47	13/12/2020 10:06	13/12/2020 07:47	13/12/2020 10:06	2,30	44	101,22	CHI
20201270745	VIANOPOLIS	OZ12084921RE	PIRES DO RIO S2	13/12/2020 07:49	14/12/2020 20:15	13/12/2020 07:49	13/12/2020 10:47	2,96	17	50,33	CHI
20201270745	ORIZONA	OZ12084921RE	PIRES DO RIO S2	13/12/2020 07:49	14/12/2020 20:15	13/12/2020 07:49	13/12/2020 10:47	2,96	110	325,69	CHI

20201270745	ORIZONA	OZ12084921RE	PIRES DO RIO S2	13/12/2020 07:49	14/12/2020 20:15	13/12/2020 12:13	13/12/2020 17:33	5,34	31	165,55	CHI
20201270745	VIANOPOLIS	OZ12084921RE	PIRES DO RIO S2	13/12/2020 07:49	14/12/2020 20:15	13/12/2020 12:13	13/12/2020 17:33	5,34	8	42,72	CHI
20201270745	ORIZONA	OZ12125035LD	PIRES DO RIO S2	13/12/2020 07:49	14/12/2020 20:15	13/12/2020 12:13	13/12/2020 18:50	6,62	25	165,40	CHI
20201270745	VIANOPOLIS	OZ12125035LD	PIRES DO RIO S2	13/12/2020 07:49	14/12/2020 20:15	13/12/2020 12:13	13/12/2020 18:50	6,62	9	59,54	CHI
20201270745	VIANOPOLIS	OZ12084921RE	PIRES DO RIO S2	13/12/2020 07:49	14/12/2020 20:15	13/12/2020 19:51	13/12/2020 21:47	1,93	17	32,79	CHI
20201270745	ORIZONA	OZ12084921RE	PIRES DO RIO S2	13/12/2020 07:49	14/12/2020 20:15	13/12/2020 19:51	13/12/2020 21:47	1,93	56	108,00	CHI
20201270745	ORIZONA	OZ12085001LD	PIRES DO RIO S2	13/12/2020 07:49	14/12/2020 20:15	13/12/2020 12:13	14/12/2020 08:08	19,92	20	398,38	CHI
20201270745	ORIZONA	OZ12085001LD	PIRES DO RIO S2	13/12/2020 07:49	14/12/2020 20:15	13/12/2020 12:13	14/12/2020 20:15	32,03	32	1024,93	CHI
20201270745	ORIZONA	OZ12085001LD	PIRES DO RIO S2	13/12/2020 07:49	14/12/2020 20:15	14/12/2020 08:09	14/12/2020 20:15	12,09	20	241,81	CHI
20201268295	PIRES DO RIO	OZ12056869	PIRES DO RIO S2	13/12/2020 07:51	13/12/2020 11:10	13/12/2020 07:51	13/12/2020 11:10	3,31	1	3,31	CHI
20201268295	ORIZONA	OZ12056869	PIRES DO RIO S2	13/12/2020 07:51	13/12/2020 11:10	13/12/2020 07:51	13/12/2020 11:10	3,31	16	52,93	CHI
20201270613	BURITI ALEGRE	BG21134563	ALTO BURITI	13/12/2020 07:51	13/12/2020 12:51	13/12/2020 07:51	13/12/2020 12:51	4,99	1	4,99	CHI
20201270687	CAMPO ALEGRE DE GOIAS	CM21073555	CAMPO ALEGRE DE GOIAS	13/12/2020 08:03	13/12/2020 11:05	13/12/2020 08:03	13/12/2020 11:05	3,02	1	3,02	CHI
20201270833	ITUMBIARA	IT12000308RE	PARANAIBA	13/12/2020 08:03	15/12/2020 13:20	13/12/2020 08:03	13/12/2020 17:13	9,16	20	183,16	CHI
20201270833	ITUMBIARA	IT12000308RE	PARANAIBA	13/12/2020 08:03	15/12/2020 13:20	13/12/2020 18:27	13/12/2020 19:02	0,60	20	11,95	CHI
20201270833	ITUMBIARA	IT12000308RE	PARANAIBA	13/12/2020 08:03	15/12/2020 13:20	14/12/2020 19:12	14/12/2020 22:19	3,13	20	62,51	CHI
20201270833	ITUMBIARA	IT12000308RE	PARANAIBA	13/12/2020 08:03	15/12/2020 13:20	13/12/2020 08:03	15/12/2020 11:08	51,07	28	1430,00	CHI
20201270833	ITUMBIARA	IT13222484	PARANAIBA	13/12/2020 08:03	15/12/2020 13:20	13/12/2020 08:03	15/12/2020 11:08	51,08	31	1583,47	CHI
20201270833	ITUMBIARA	IT12040263	PARANAIBA	13/12/2020 08:03	15/12/2020 13:20	13/12/2020 08:03	15/12/2020 11:50	51,78	5	258,92	CHI
20201270833	ITUMBIARA	IT12040311	PARANAIBA	13/12/2020 08:03	15/12/2020 13:20	13/12/2020 08:03	15/12/2020 12:04	52,00	4	208,01	CHI
20201270833	ITUMBIARA	IT12000308RE	PARANAIBA	13/12/2020 08:03	15/12/2020 13:20	13/12/2020 08:03	15/12/2020 13:20	53,28	4	213,10	CHI
20201270833	ITUMBIARA	IT13222538	PARANAIBA	13/12/2020 08:03	15/12/2020 13:20	15/12/2020 12:59	15/12/2020 13:20	0,36	68	24,16	CHI
20201270949	BURITI ALEGRE	BG12000103	ITUMBIARA VELHA S2	13/12/2020 08:10	13/12/2020 10:17	13/12/2020 08:10	13/12/2020 10:17	2,11	40	84,46	CHI
20201270748	INDIARA	10029540907	EDEIA	13/12/2020 08:13	13/12/2020 16:01	13/12/2020 08:13	13/12/2020 16:01	7,81	1	7,81	CHI
20201270756	CUMARI	CY21127598	CATALAO S1	13/12/2020 08:13	13/12/2020 11:39	13/12/2020 08:13	13/12/2020 11:39	3,42	1	3,42	CHI
20201270760	SANTA CRUZ DE GOIAS	BC21095329	PIRES DO RIO S2	13/12/2020 08:13	13/12/2020 11:33	13/12/2020 08:13	13/12/2020 11:33	3,32	1	3,32	CHI
20201270807	EDEALINA	VI12263850	VICENTINOPOLIS	13/12/2020 08:22	13/12/2020 10:28	13/12/2020 08:22	13/12/2020 10:28	2,10	2	4,19	CHI
20201270807	VICENTINOPOLIS	VI12263850	VICENTINOPOLIS	13/12/2020 08:22	13/12/2020 10:28	13/12/2020 08:22	13/12/2020 10:28	2,10	1	2,10	CHI
20201270814	GOIATUBA	140059581	GOIATUBA S2	13/12/2020 08:23	13/12/2020 11:37	13/12/2020 08:23	13/12/2020 11:37	3,23	1	3,23	CHI
20201270848	CORUMBAIBA	10008864274	VILA CORUMBA	13/12/2020 08:27	13/12/2020 11:58	13/12/2020 08:27	13/12/2020 11:58	3,50	1	3,50	CHI
20201270851	PIRACANJUBA	MR21000163	MORRINHOS	13/12/2020 08:28	13/12/2020 09:50	13/12/2020 08:28	13/12/2020 09:50	1,36	1	1,36	CHI
20201270858	AGUA LIMPA	AL21075703	VILA CORUMBA	13/12/2020 08:29	13/12/2020 17:30	13/12/2020 08:29	13/12/2020 17:30	9,01	1	9,01	CHI
20201271831	ORIZONA	OZ12073391	PIRES DO RIO S2	13/12/2020 08:29	13/12/2020 13:46	13/12/2020 08:29	13/12/2020 13:46	5,28	9	47,49	CHI
20201271744	IPAMERI	10030803541	PIRES DO RIO S2	13/12/2020 08:30	14/12/2020 02:13	13/12/2020 08:30	14/12/2020 02:13	17,71	1	17,71	CHI
20201270926	ITUMBIARA	IT12273873RE	ITUMBIARA NOVA	13/12/2020 08:40	13/12/2020 12:11	13/12/2020 08:40	13/12/2020 12:11	3,51	1	3,51	CHI
20201270926	PANAMA	IT12273873RE	ITUMBIARA NOVA	13/12/2020 08:40	13/12/2020 12:11	13/12/2020 08:40	13/12/2020 12:11	3,51	16	56,11	CHI
20201271853	ITUMBIARA	CD12000232	CACHOEIRA DOURADA	13/12/2020 08:42	13/12/2020 14:56	13/12/2020 08:42	13/12/2020 14:56	6,22	5	31,09	CHI
20201270947	MORRINHOS	MR21049688	MORRINHOS	13/12/2020 08:43	13/12/2020 10:36	13/12/2020 08:43	13/12/2020 10:36	1,88	1	1,88	CHI
20201270948	CATALAO	GD21063893	CATALAO S1	13/12/2020 08:43	13/12/2020 10:40	13/12/2020 08:43	13/12/2020 10:40	1,95	1	1,95	CHI
20201270962	OUVIDOR	2180018739	CATALAO S1	13/12/2020 08:44	13/12/2020 11:47	13/12/2020 08:44	13/12/2020 11:47	3,05	1	3,05	CHI
20201271036	CATALAO	IP12234083	IPAMERI	13/12/2020 08:57	13/12/2020 10:18	13/12/2020 08:57	13/12/2020 10:18	1,34	2	2,68	CHI
20201273096	DAVINOPOLIS	IO12266778	CATALAO S1	13/12/2020 08:57	13/12/2020 18:35	13/12/2020 08:57	13/12/2020 18:35	9,62	13	125,05	CHI
20201273096	DISTRITO FEDERAL	IO12266778	CATALAO S1	13/12/2020 08:57	13/12/2020 18:35	13/12/2020 08:57	13/12/2020 18:35	9,62	1	9,62	CHI

5. Plotagem das Ocorrências conforme a Especialização das Chuvas

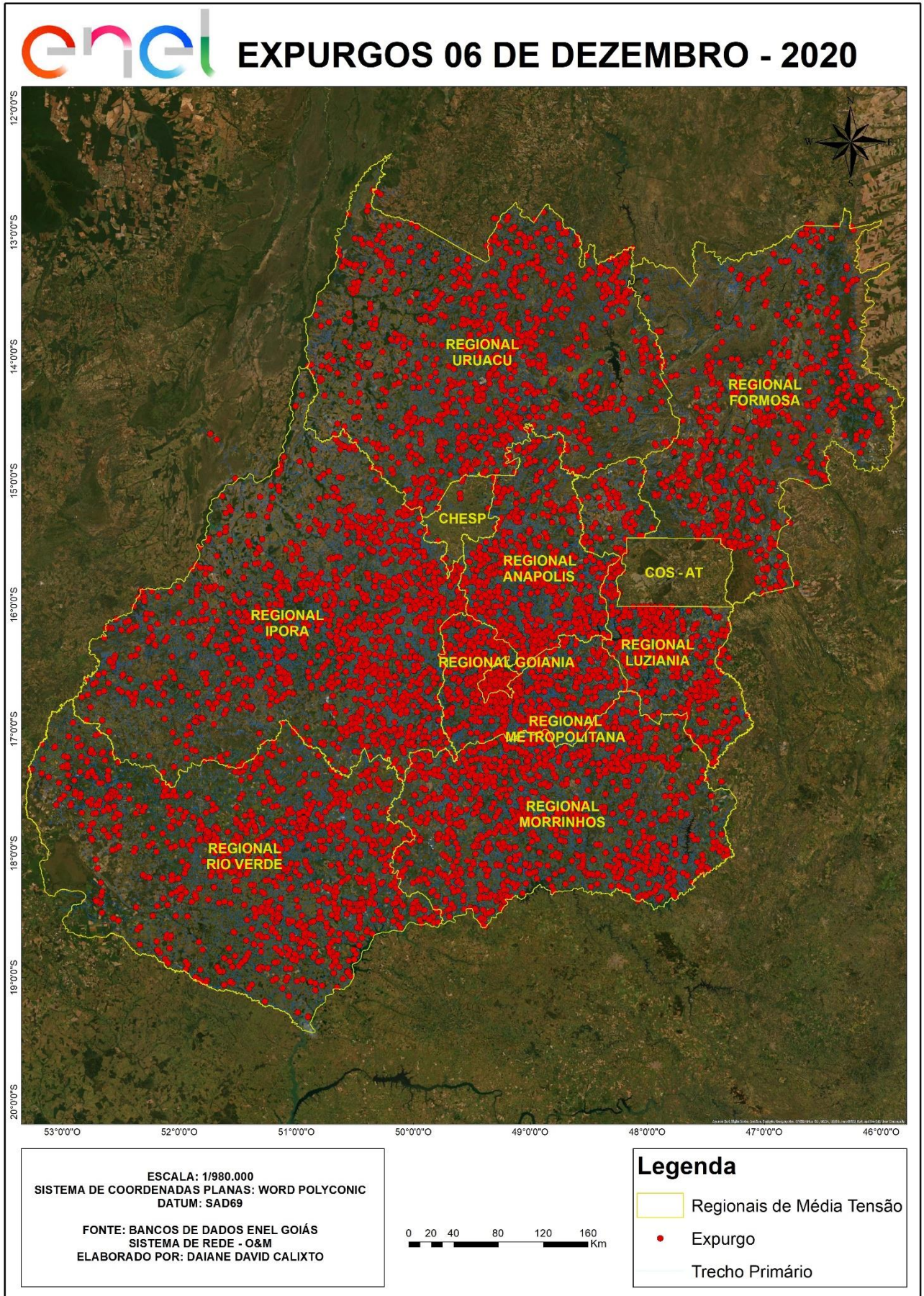

6. Clientes Afetados e Impactos Globais

Em análise ao número de clientes interrompidos (CI) na área de concessão da ENEL GO, a figura abaixo apresenta a atipicidade vivenciada nos dias 06 a 13 de dezembro de 2020, data esta que, conforme laudo meteorológico emitido por empresa especializada, a referida concessão passou por um período de condições climáticas de extrema severidade.

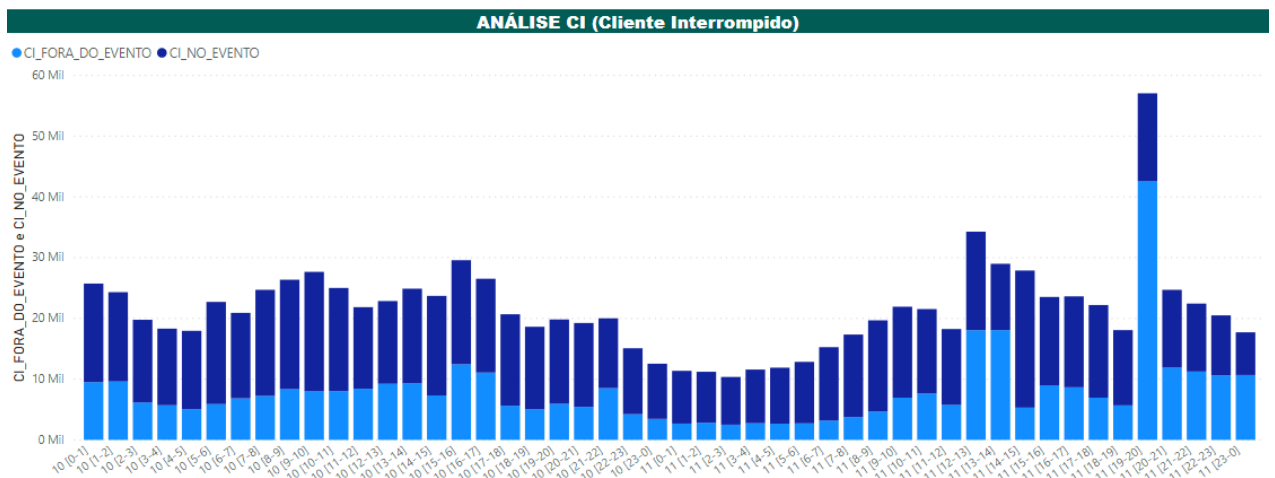
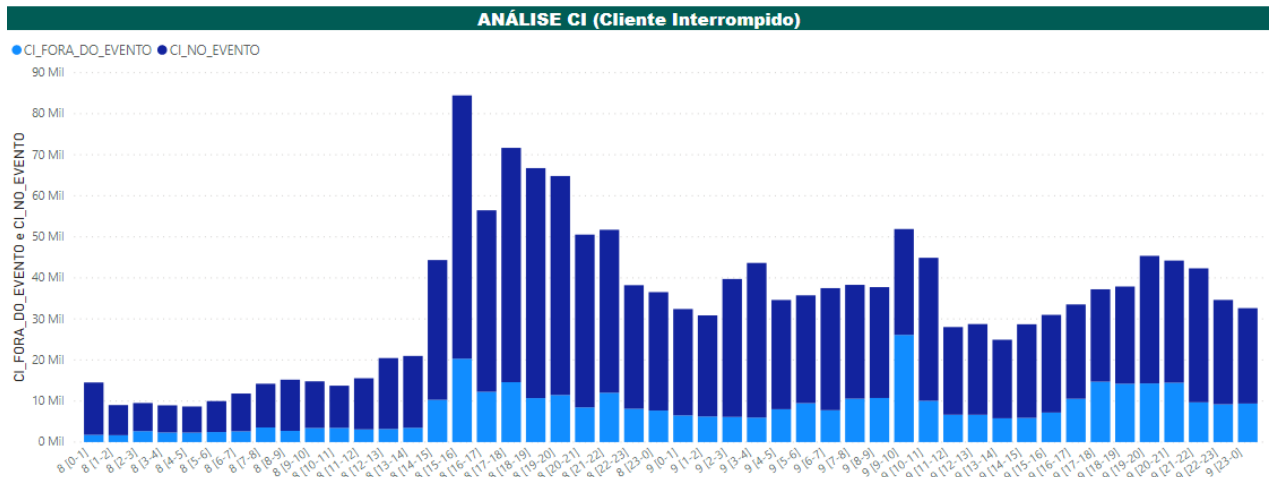
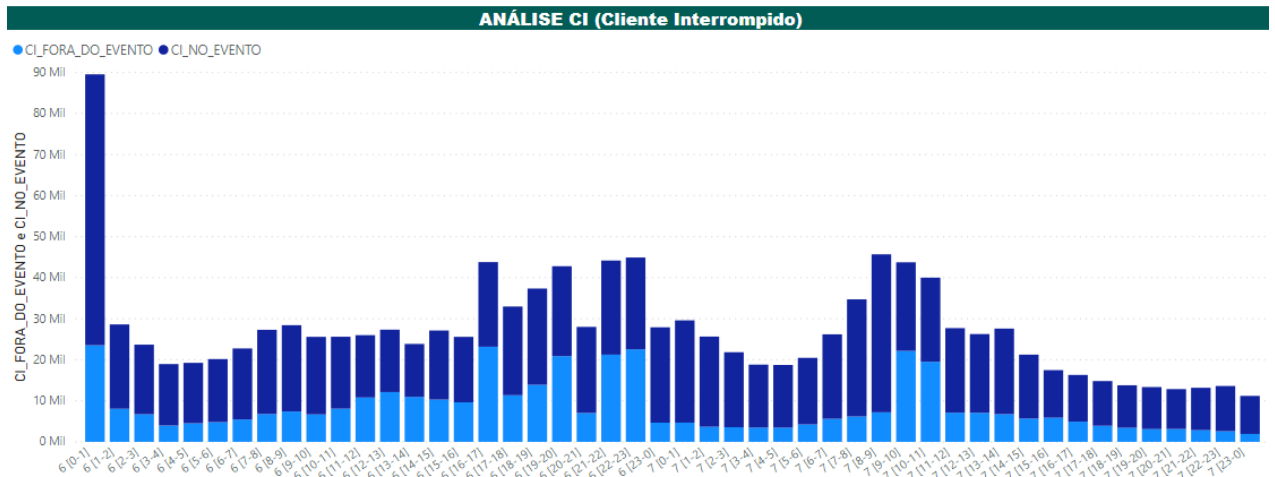

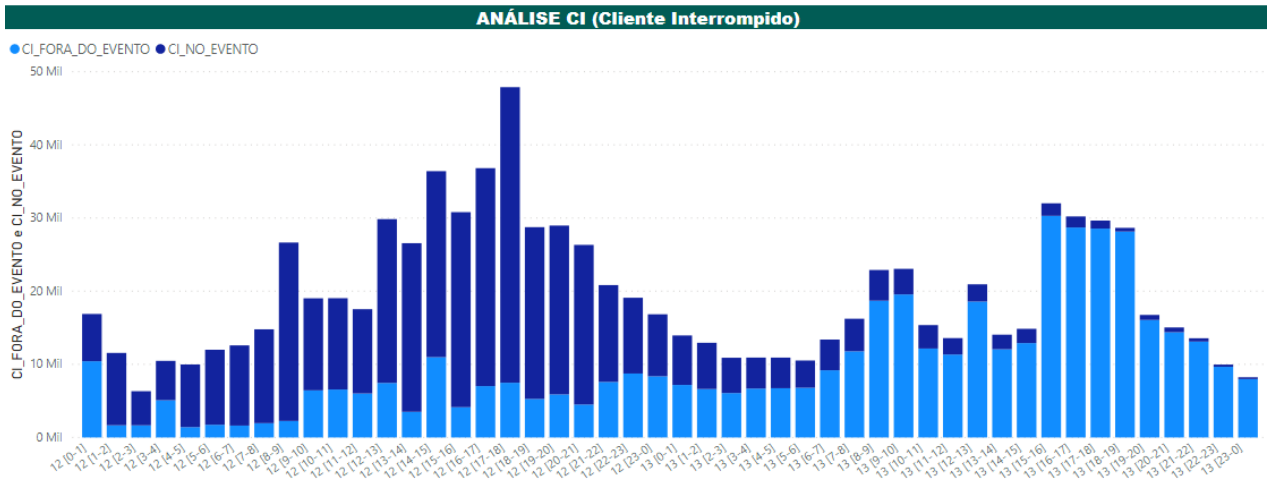

Figuras – Clientes Interrompidos em intervalos de horas

Na figura acima, as barras em azul claro representam a quantidade de clientes interrompidos simultaneamente em condições normais de operação, e as barras azul escuro os clientes interrompidos simultaneamente no período do evento.

7. Diagramas Unifilares

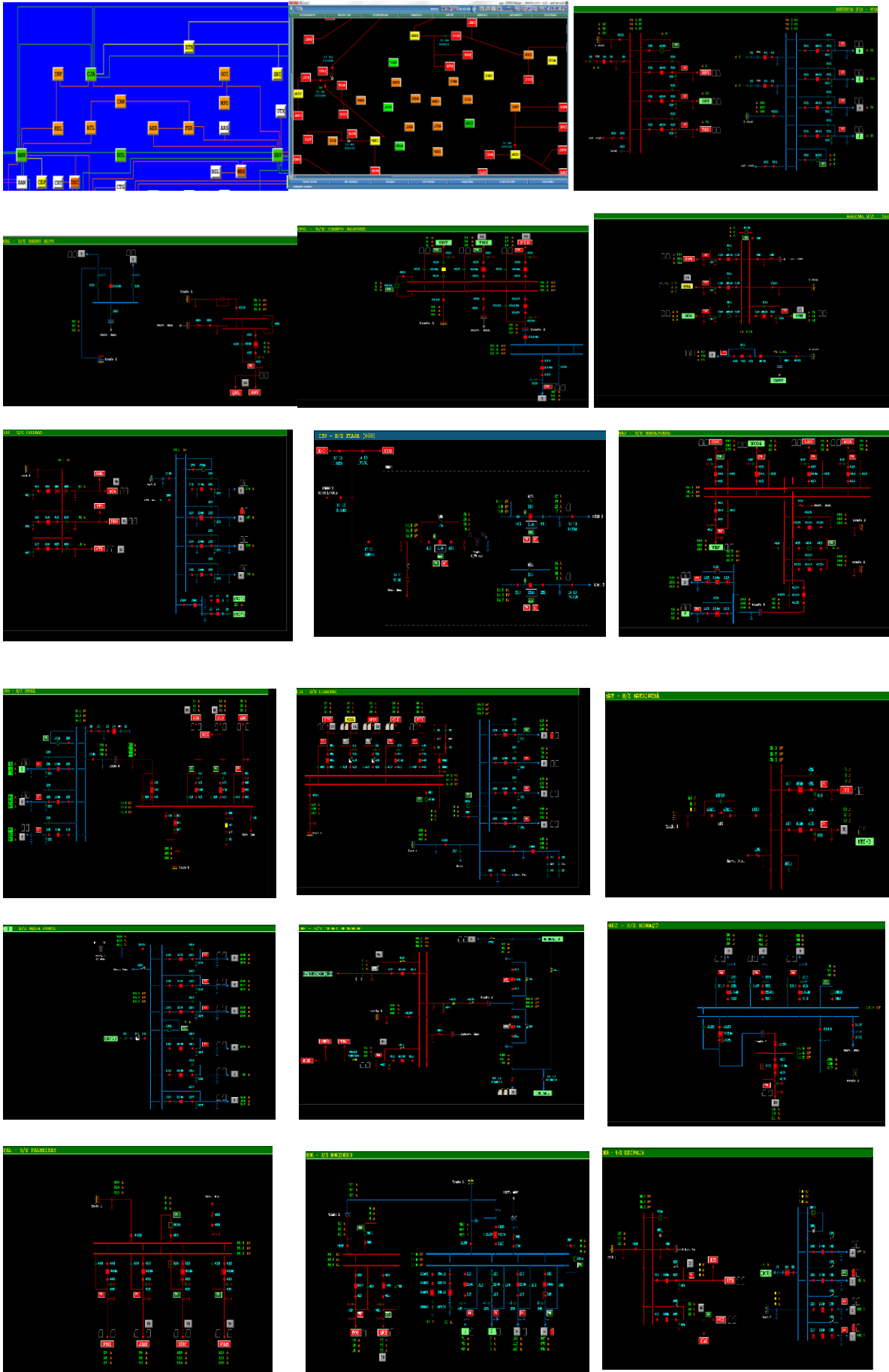

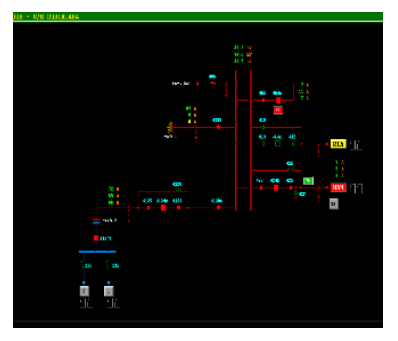
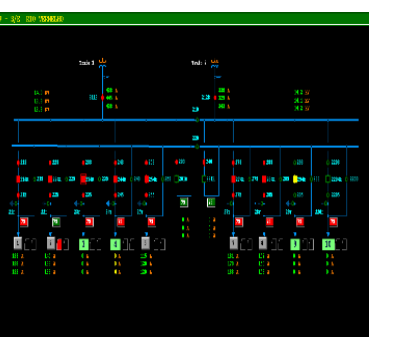
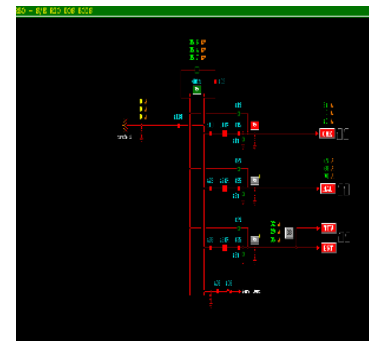
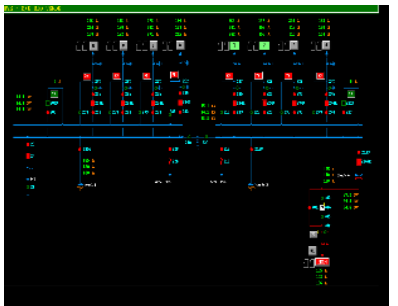
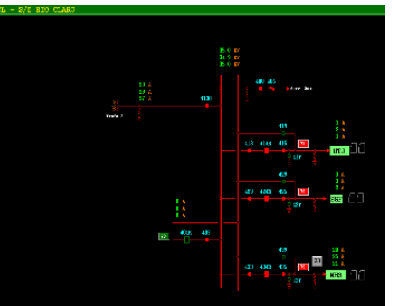
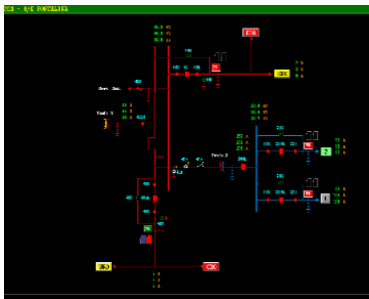
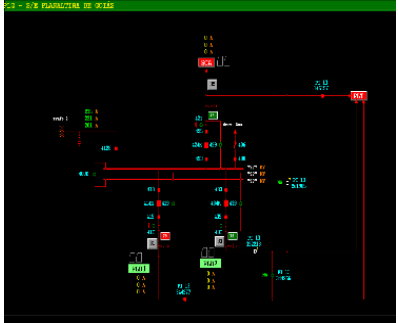
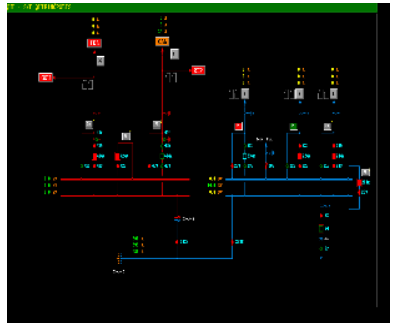
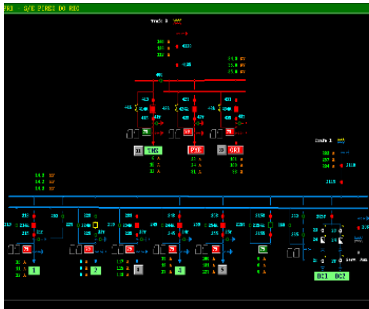
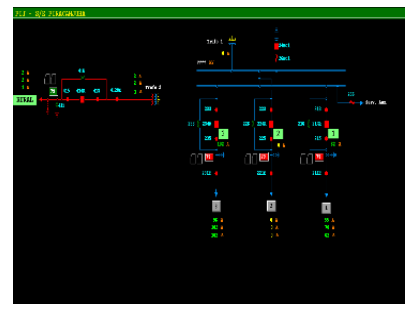
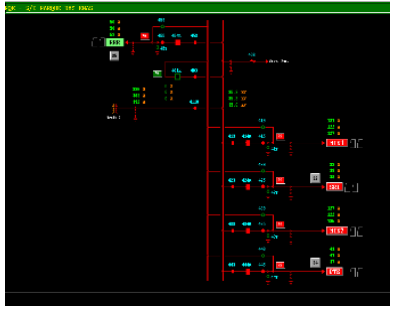
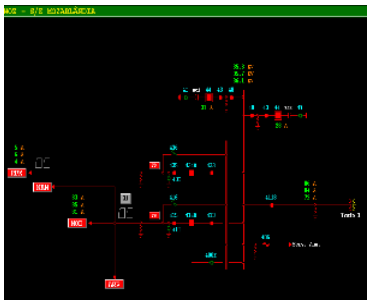
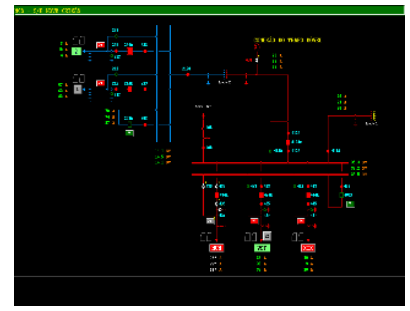
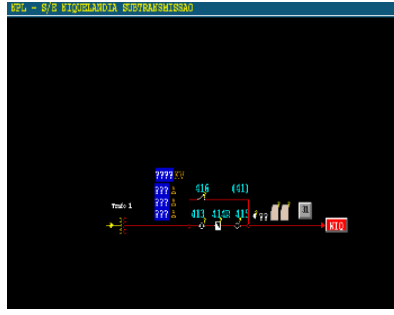

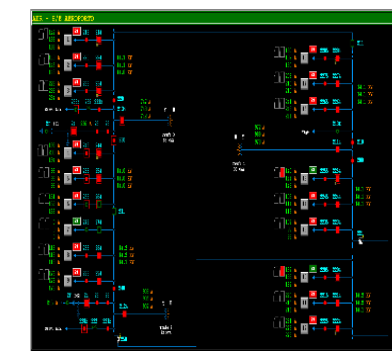
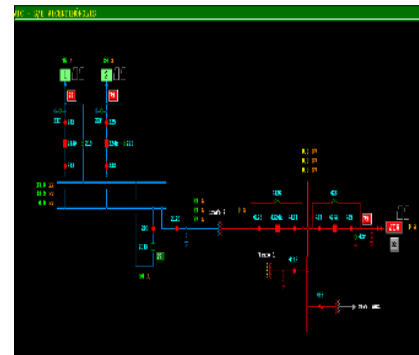
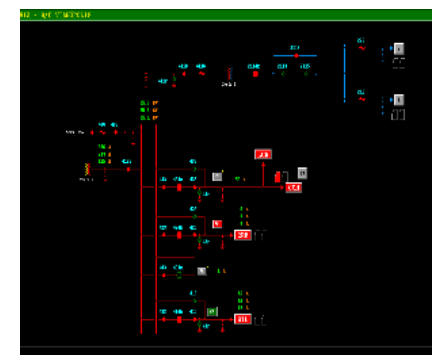
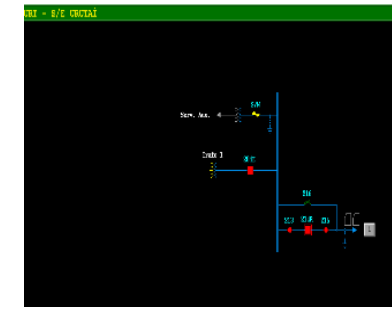
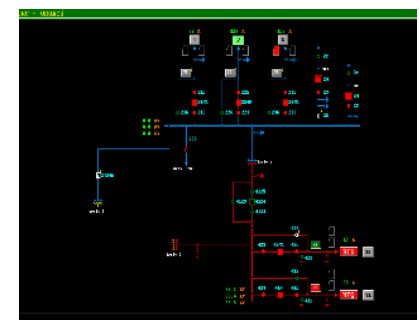
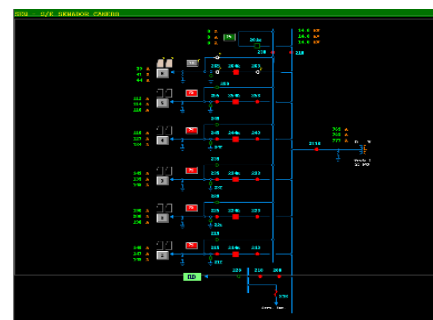
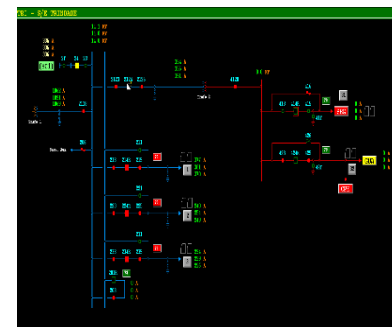
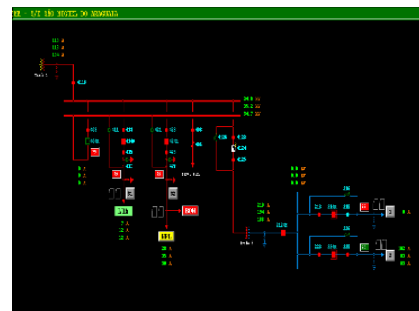
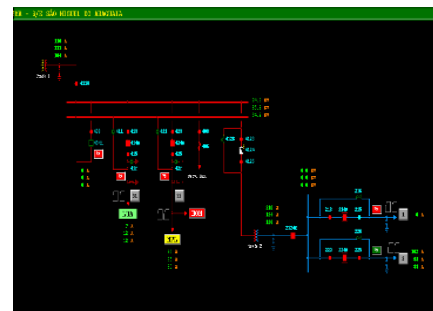
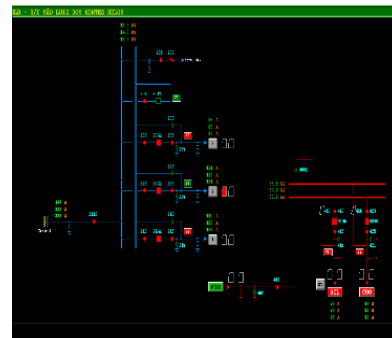
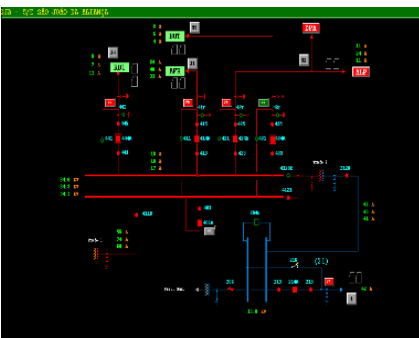
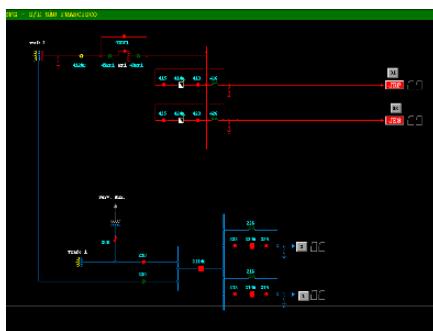
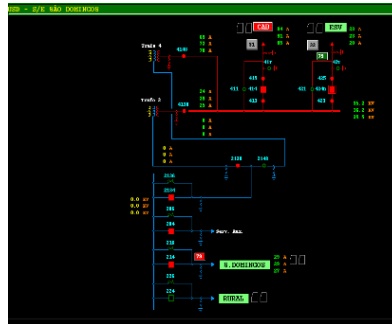
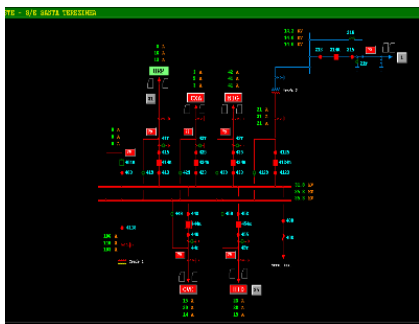
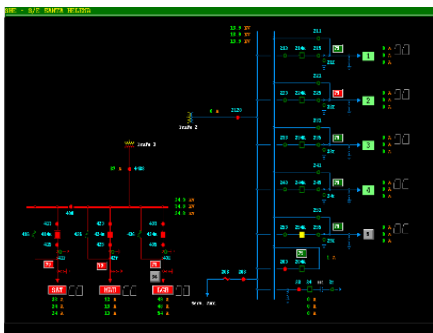

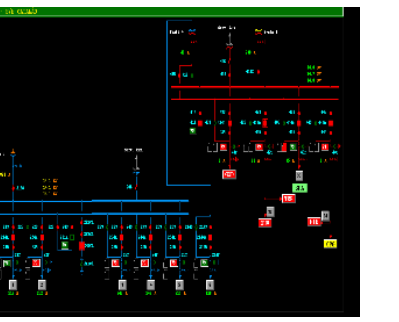
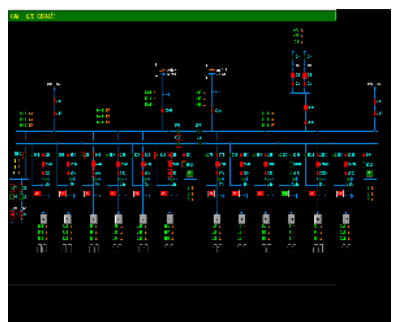
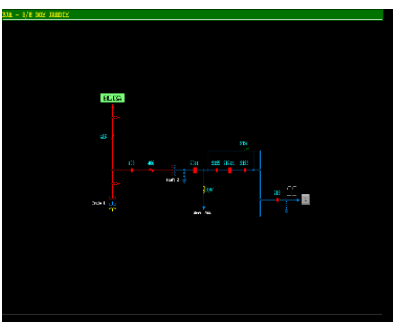
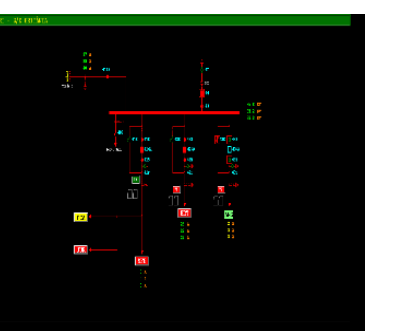
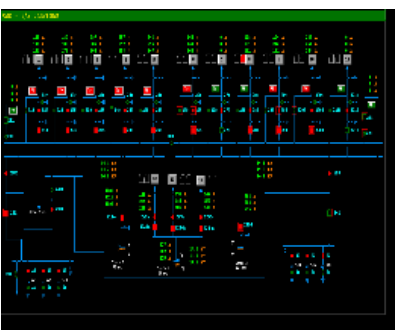
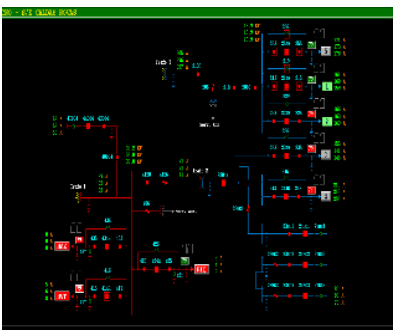
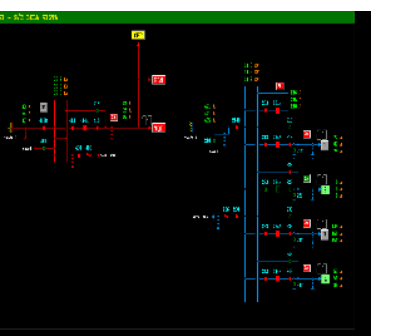
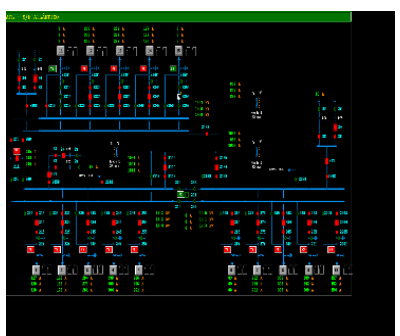
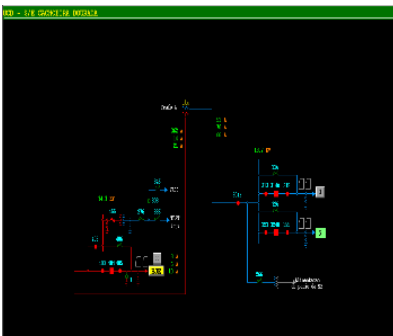
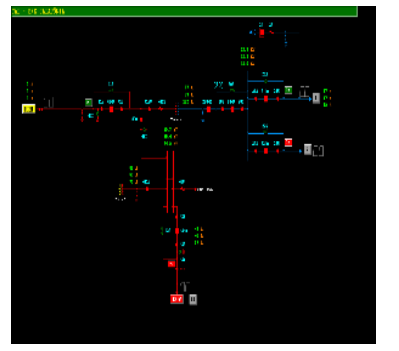
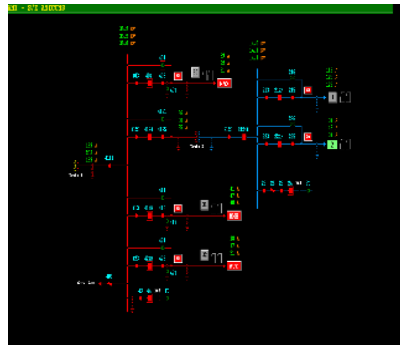
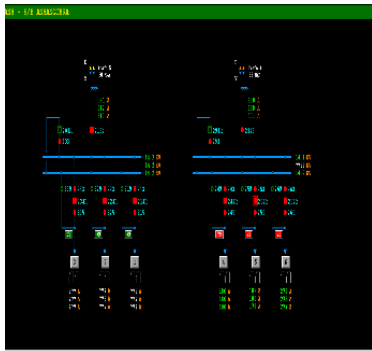
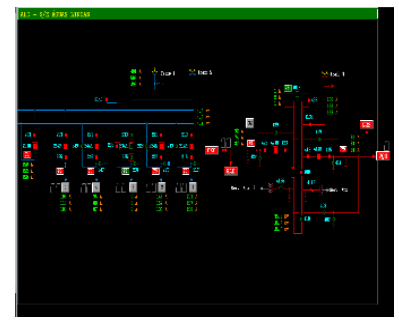
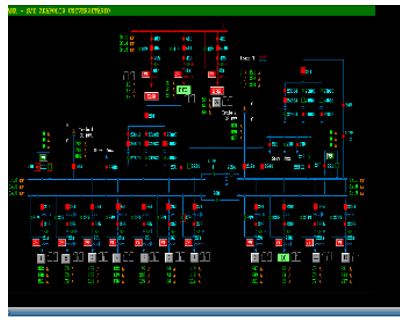
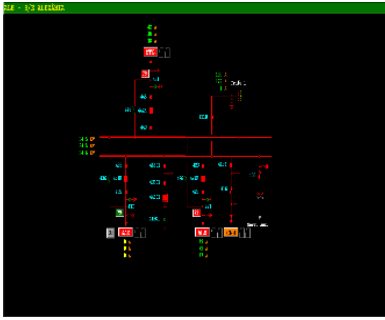

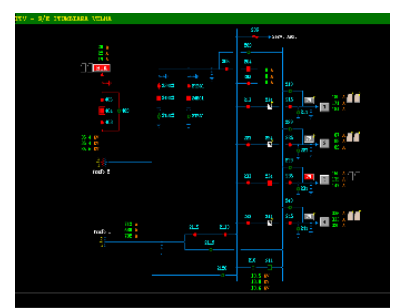
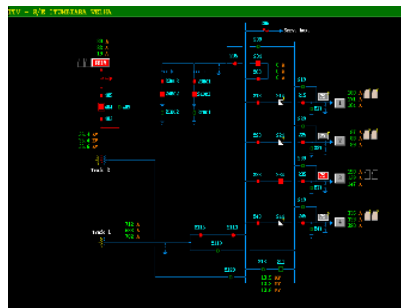
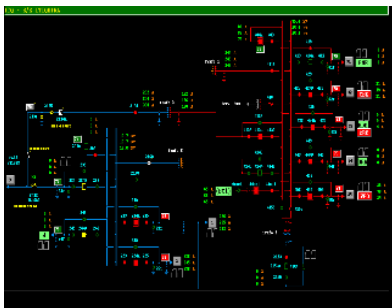
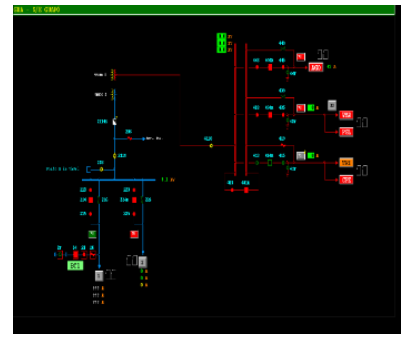
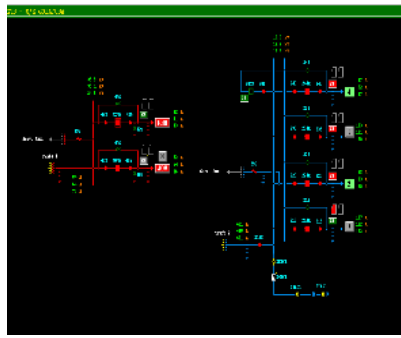
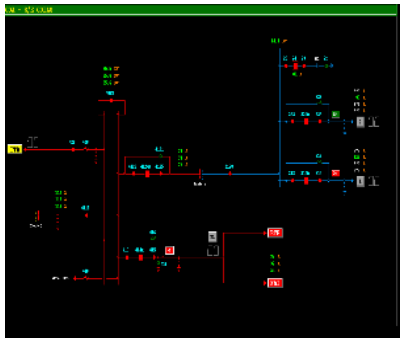
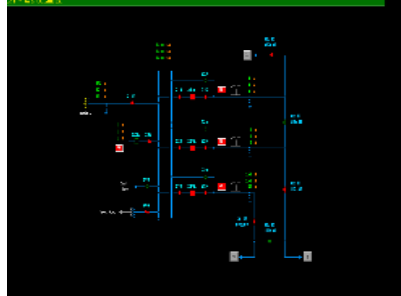
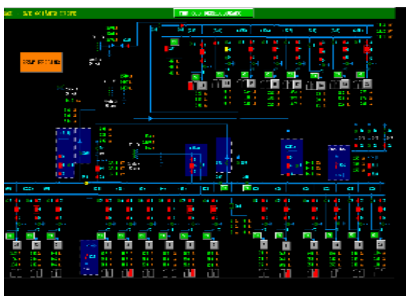
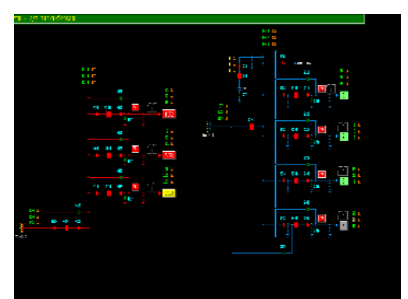
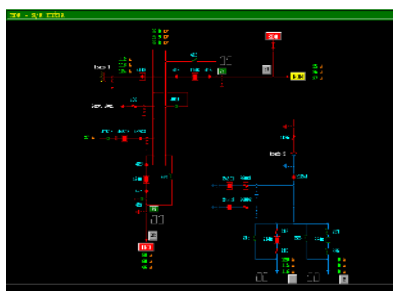
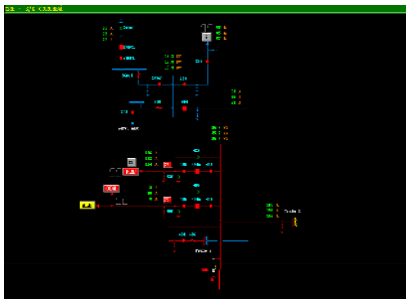
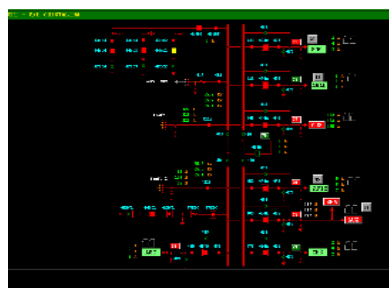
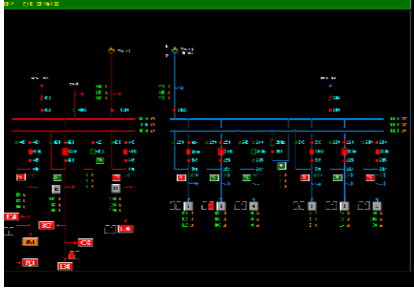
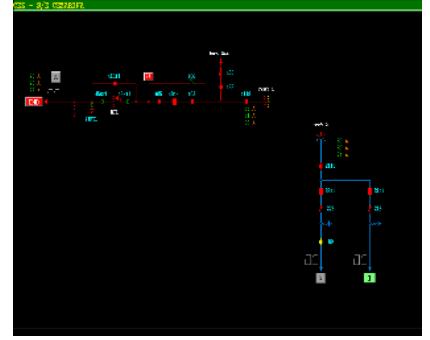
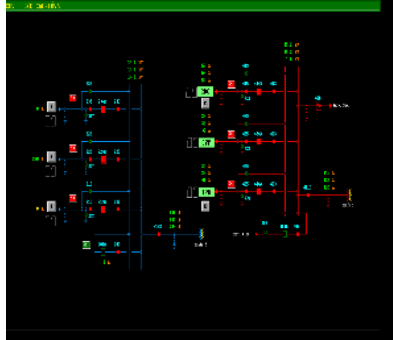
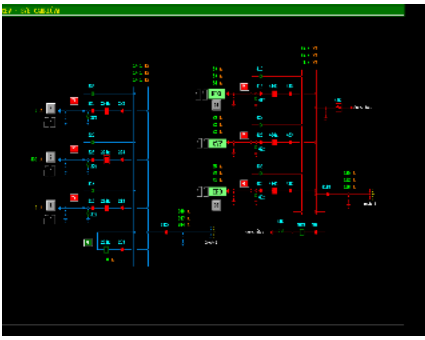

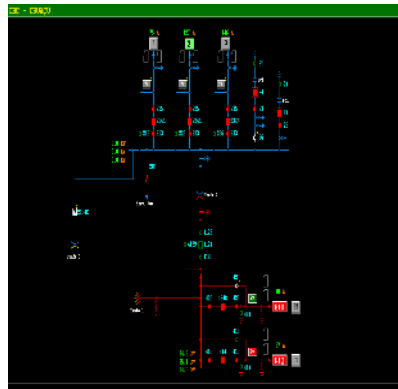
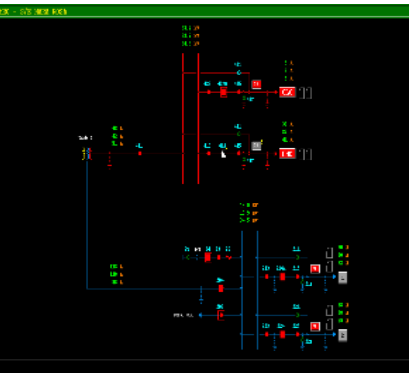
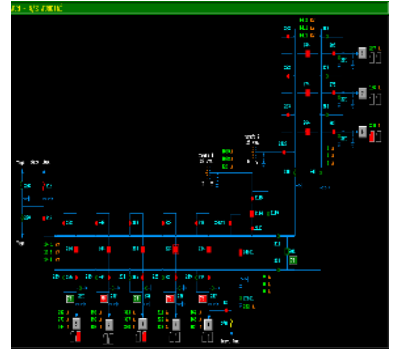
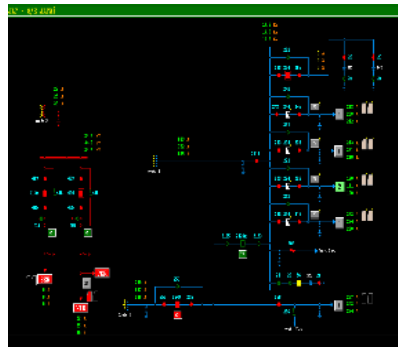
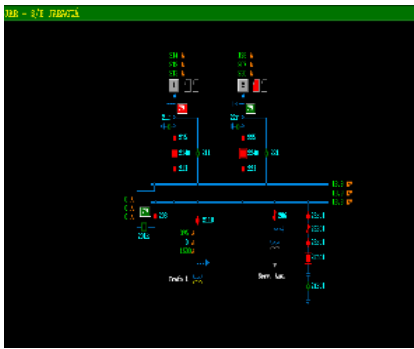

8. DEMAIS EVIDÊNCIAS

8.1. DADOS TÉCNICO - OPERACIONAIS ENEL GO

Enel - GO

TMAE e OE por Dia - Dezembro 2020

● Contagem de Ocorrências ● TMAE

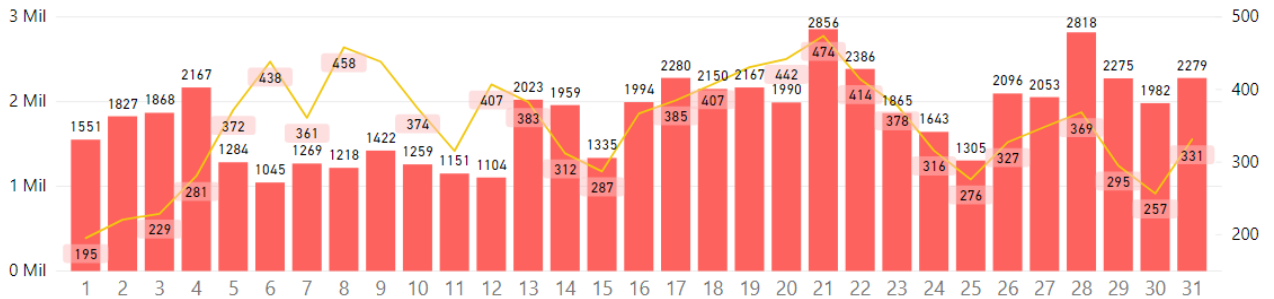

Regional Anápolis – GO

TMAE e OE por Dia - Dezembro 2020

● Contagem de Ocorrências ● TMAE

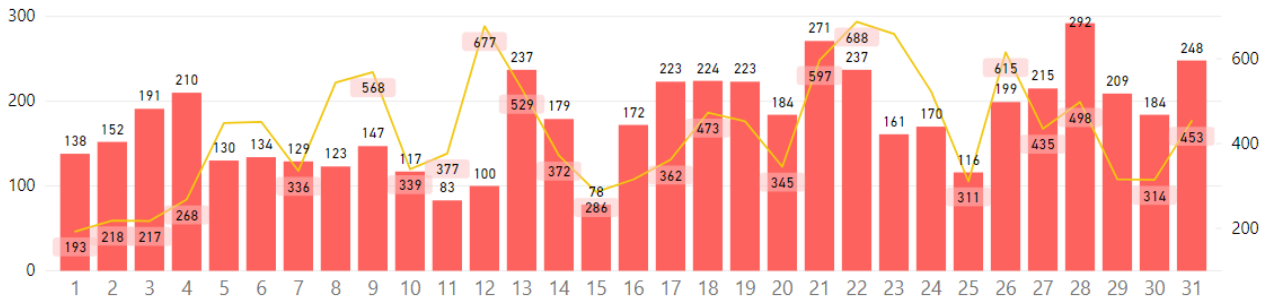

Regional Formosa – GO

TMAE e OE por Dia - Dezembro 2020

● Contagem de Ocorrências ● TMAE

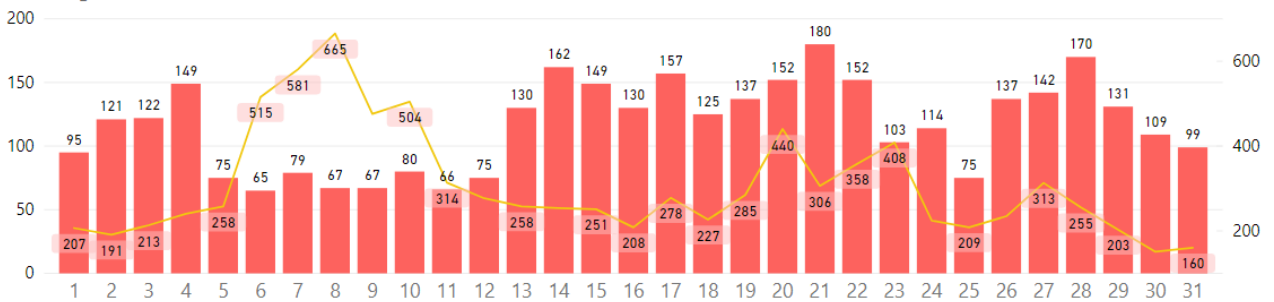

Regional Goiânia – GO

TMAE e OE por Dia - Dezembro 2020

● Contagem de Ocorrências ● TMAE

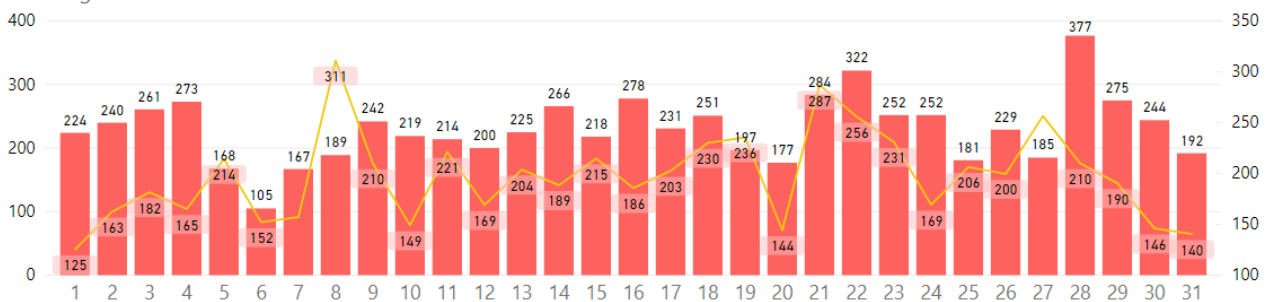

Regional Iporá – GO

TMAE e OE por Dia - Dezembro 2020

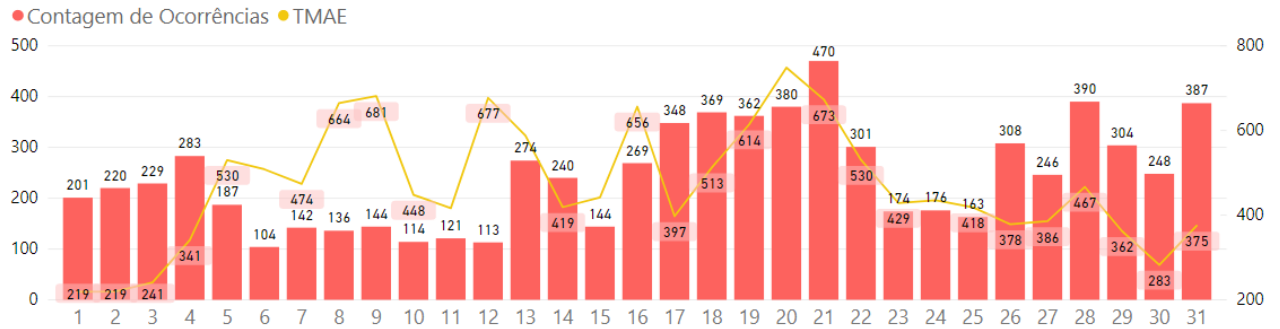

Regional Luziânia – GO

TMAE e OE por Dia - Dezembro 2020

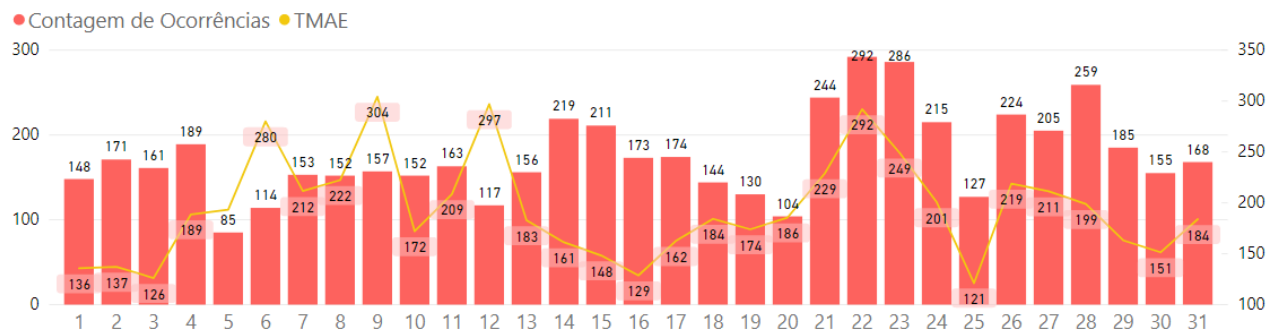

Regional Metropolitana – GO

TMAE e OE por Dia - Dezembro 2020

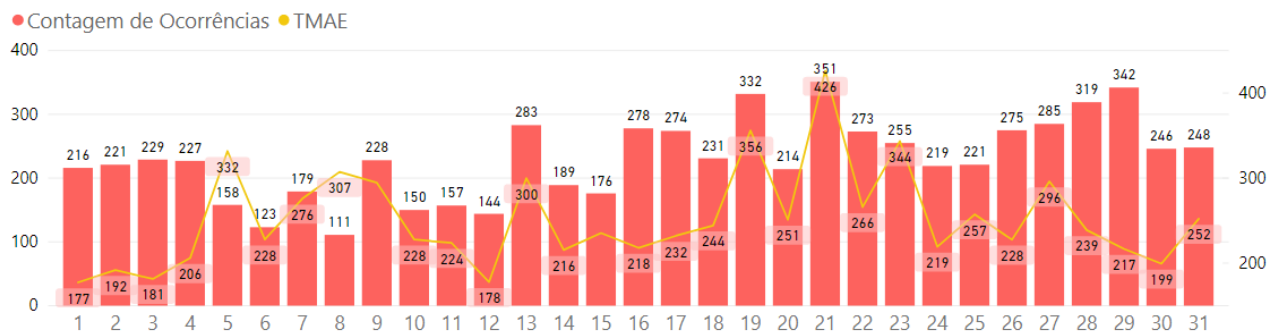

Regional Morrinhos – GO

TMAE e OE por Dia - Dezembro 2020

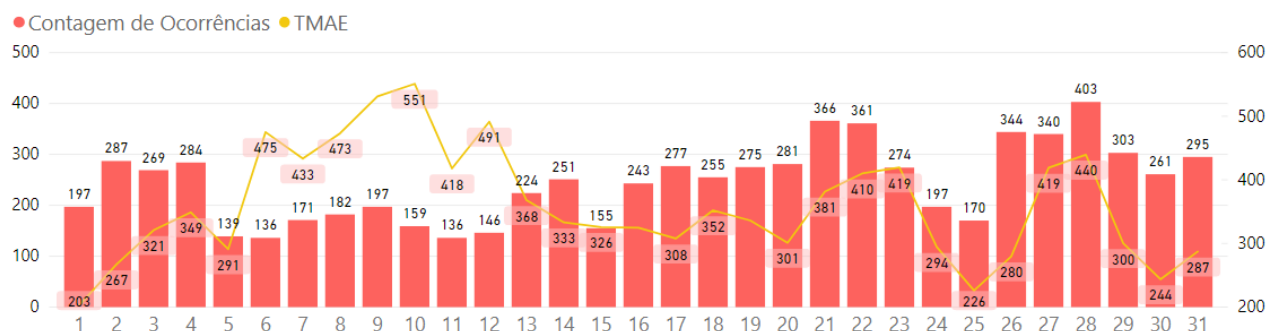

Regional Rio Verde – GO

TMAE e OE por Dia - Dezembro 2020

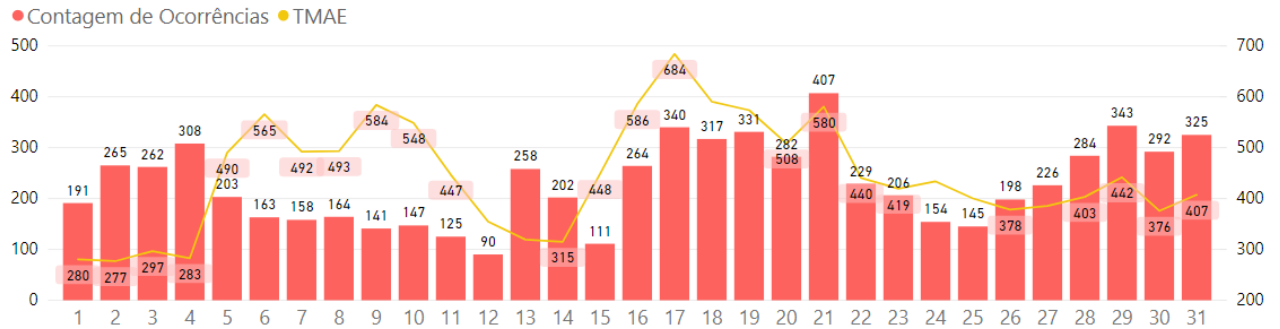

Regional Uruaçu - GO

TMAE e OE por Dia - Dezembro 2020

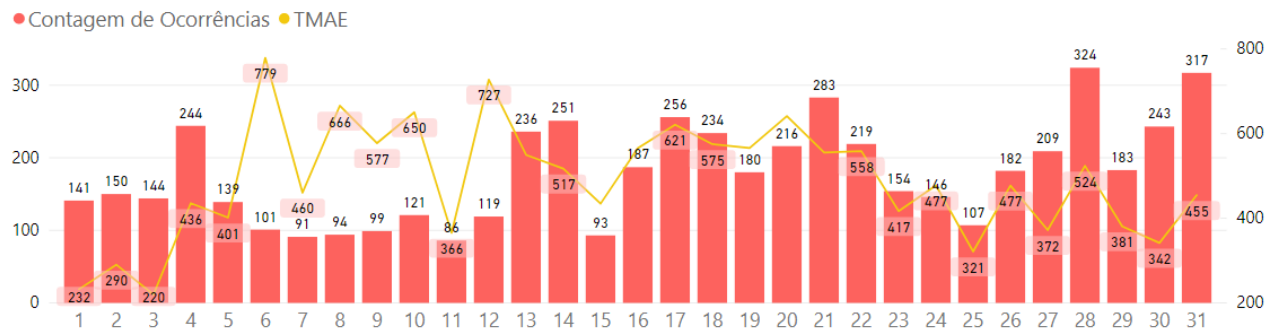

8.2. Dados climatológicos pelo INMET

Instituto Nacional de Meteorologia – INMET

Chuva Acumulada em 24h || Estação: ARAGARCAS (83368) – 12/2020

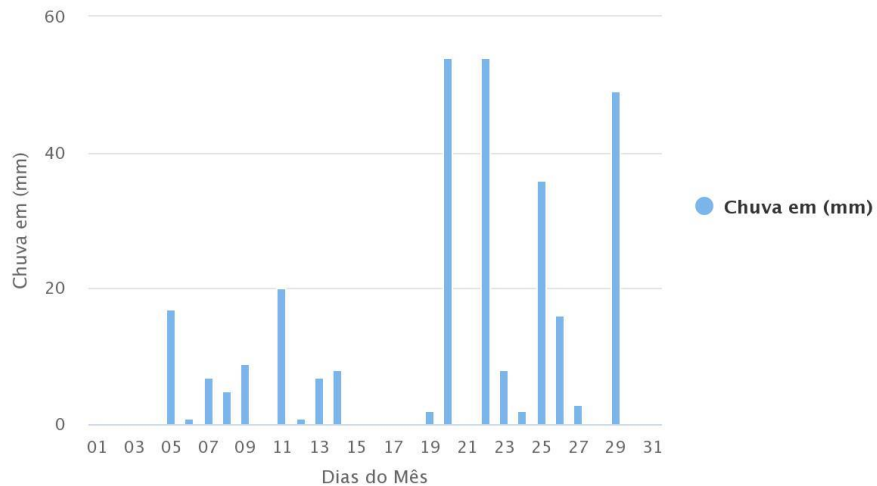

Instituto Nacional de Meteorologia – INMET

Chuva Acumulada em 24h || Estação: CATALAO (83526) – 12/2020

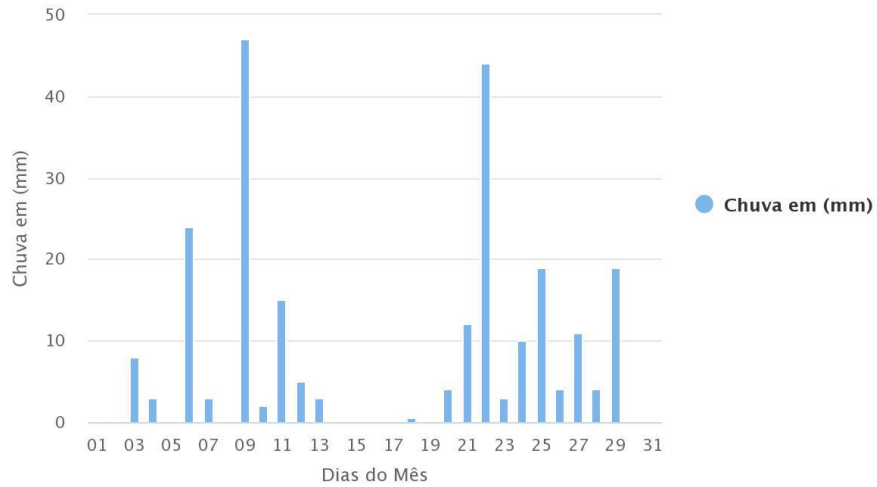

Highcharts.com

Instituto Nacional de Meteorologia – INMET

Chuva Acumulada em 24h || Estação: FORMOSA (83379) – 12/2020

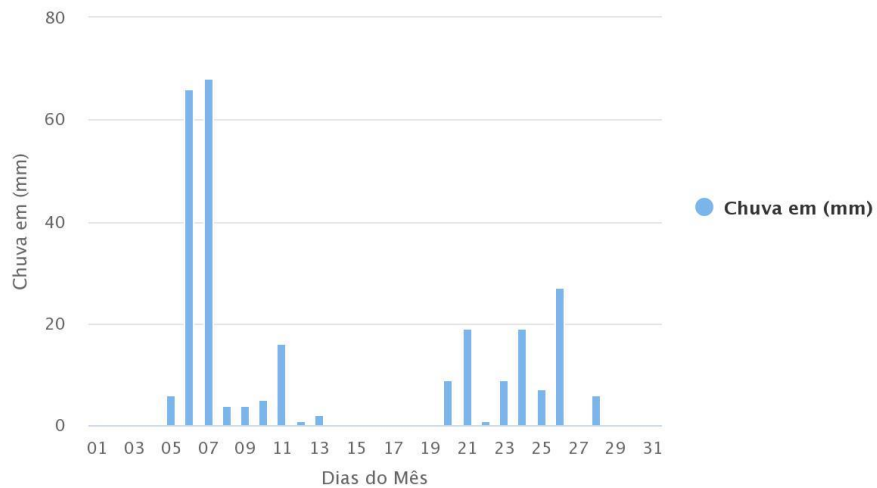

Highcharts.com

Instituto Nacional de Meteorologia – INMET

Chuva Acumulada em 24h || Estação: GOIANIA (83423) – 12/2020

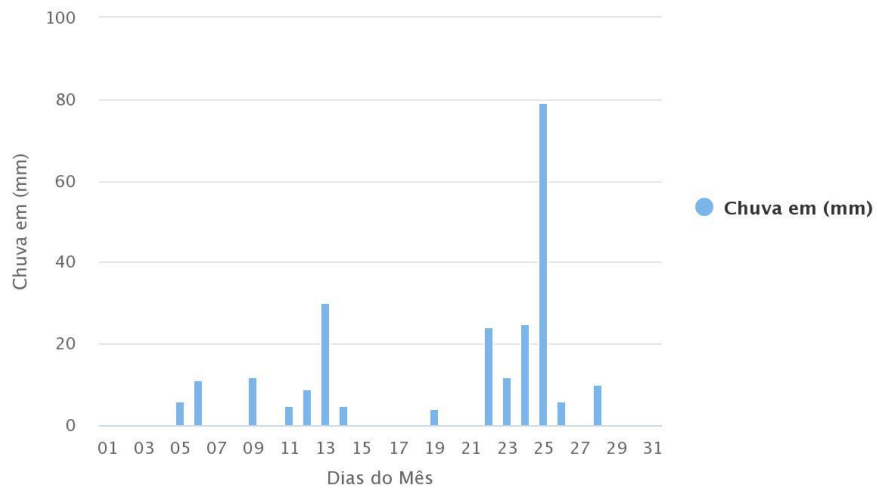

Highcharts.com

Instituto Nacional de Meteorologia – INMET

Chuva Acumulada em 24h || Estação: IPAMERI (83522) – 12/2020

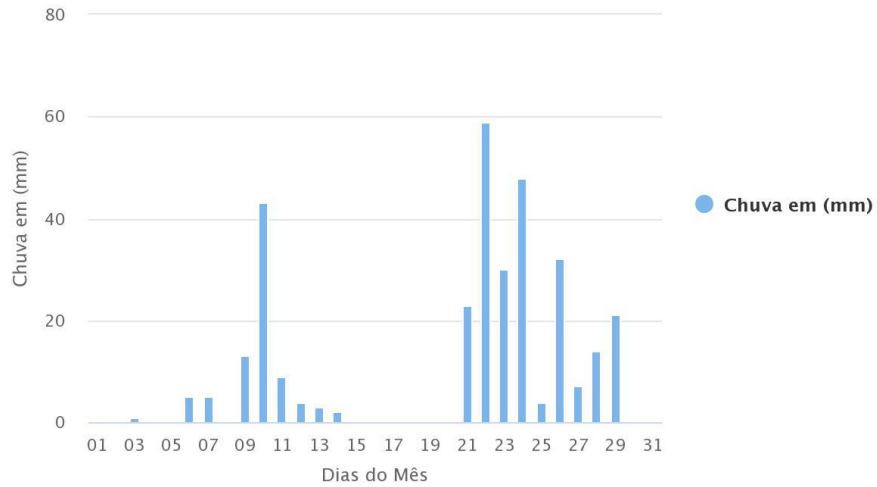

Highcharts.com

Instituto Nacional de Meteorologia – INMET

Chuva Acumulada em 24h || Estação: JATAI (83464) – 12/2020

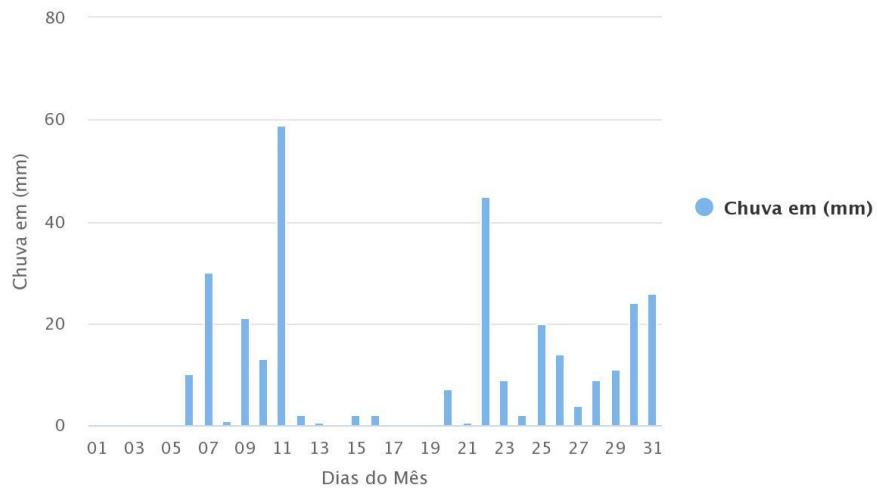

Highcharts.com

Instituto Nacional de Meteorologia – INMET

Chuva Acumulada em 24h || Estação: PIRENOPOLIS (83376) – 12/2020

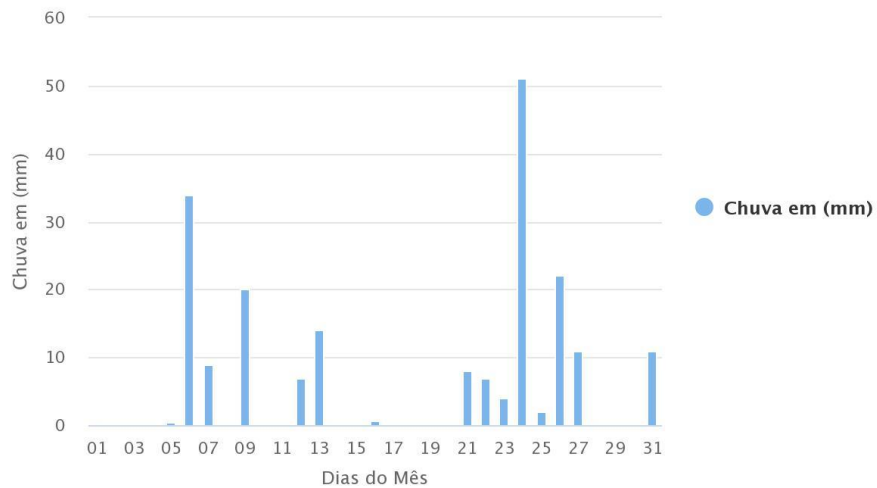

Highcharts.com

Instituto Nacional de Meteorologia – INMET

Chuva Acumulada em 24h || Estação: POSSE (83332) – 12/2020

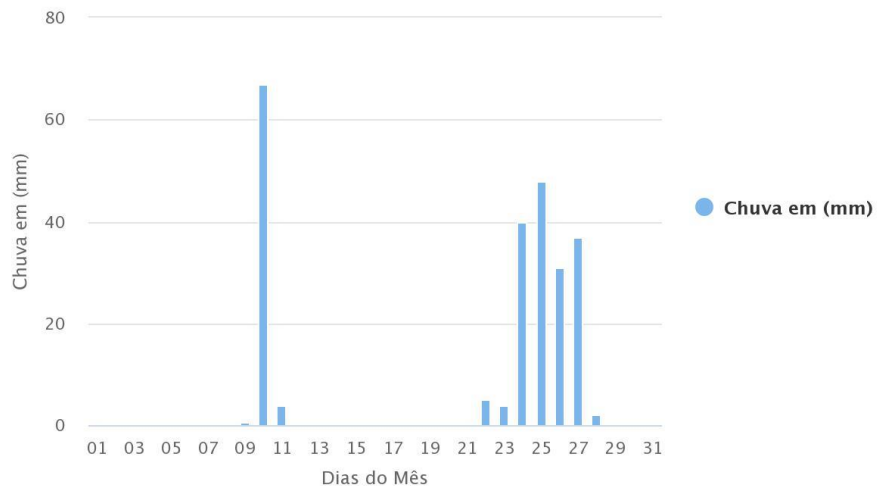

Highcharts.com

Instituto Nacional de Meteorologia – INMET

Chuva Acumulada em 24h || Estação: RIO VERDE (83470) – 12/2020

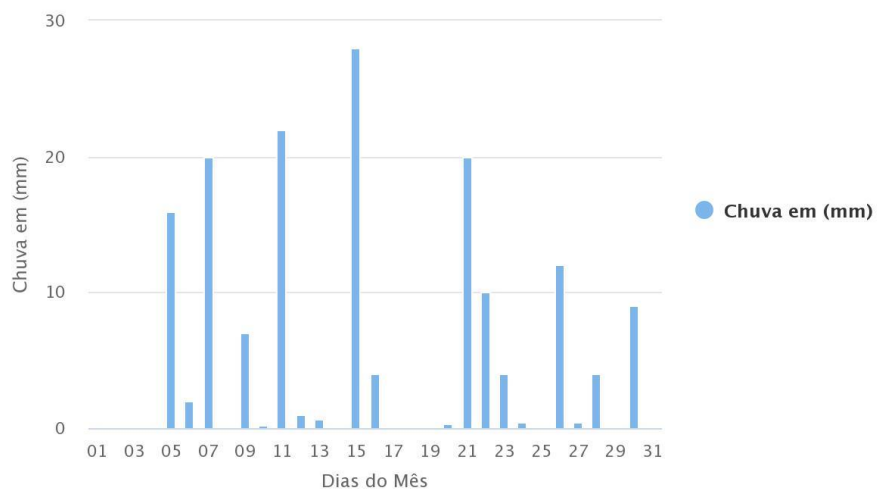

Highcharts.com

9. NOTÍCIAS RELACIONADAS

<https://www.instagram.com/p/Cldt5enF87-/>



maisgoias • Seguindo

maisgoias Tempo: chove nesse momento na cidade de Pirenópolis. Vídeo @manoellgomes

12 sem

94.270 visualizações

6 DE DEZEMBRO DE 2020

Adicione um comentário... **Publicar**

<https://www.instagram.com/p/CIn7NPEFahr/>



maisgoias • Seguindo

maisgoias Situação do trânsito na região do Detran!

12 sem

50.156 visualizações

10 DE DEZEMBRO DE 2020

Adicione um comentário... **Publicar**

walterluismoraes Essa bagunça começou la atrás com IRIS REZENDE que dizia que tinha que fazer asfalto porquê galeria pluvial o eleitor não via e não dava voto. Quem é cinquentão se puxar pela memória sabe do que falo.

12 sem Responder

<https://www.instagram.com/p/ClqwzbSIP0p/>

maisgoiás

Previsão para Goiás é de chuvas e descargas elétricas no fim de semana

maisgoiás • Seguindo

maisgoiás A previsão do tempo para Goiás é de chuvas intensas e descargas elétricas neste sábado (12) e domingo (13). Em Goiânia, há possibilidade de chuvas mais fortes no sábado e pancadas isoladas no domingo.

Conforme a previsão do Centro de Informações Meteorológicas e Hidrológicas do Estado de Goiás (Cimehgo), na Região Norte o frio não será tão intenso. A mínima prevista é de 22°, com máxima de 33°.

Já para região Oeste, a temperatura mínima deve ser de 20° e a máxima de 32°. No Leste, os goianos irão

Curtido por **camiloaraujoegito** e outras 10.354 pessoas

11 DE DEZEMBRO DE 2020

Adicione um comentário... **Publicar**

<https://www.instagram.com/p/ClqyUe8F3Pa/>

maisgoiás • Seguindo

maisgoiás Tempo: chove forte na região da 44.

11 sem

+

caiodasilva615 Normal ne toda vez q chove 😊

11 sem Responder

havertonluciooliveira Na Galeria Passarela da Moda

11 sem Responder

italobf Biz é mato!!! 😂

79.764 visualizações

11 DE DEZEMBRO DE 2020

Adicione um comentário... **Publicar**

https://www.instagram.com/p/C1qX_aMF92I/



maisgoias • Seguindo
Áudio original

maisgoias Tempo: chove forte em vários bairros de Goiânia. Imagem registrada na região do centro da capital. Vídeo @rogerseabra

11 sem

+

ivonemourads Que lindo ! Amo minha terra natal ❤️

11 sem 2 curtidas Responder

geologo.humbertopereira Belo vídeo e a chuva foi forte no setor Sul aqui em Goiânia

👍 💬 📍 🏷️

Curtido por **dener_armando** e outras 7.019 pessoas

11 DE DEZEMBRO DE 2020

😊 Adicione um comentário... **Publicar**

<https://www.instagram.com/p/C1qXhiolul0/>



maisgoias • Seguindo

maisgoias Situação na Perimetral Norte - nas proximidades do shopping Passeio das Águas

11 sem

+

silvestre.lopez.773 Mais o nome já fala passeio das águas

11 sem Responder

carlacristinadearaujo Passeio pelas águas. Tudo certo

11 sem Responder

antonia7762 Kkk o nome

👍 💬 📍 🏷️

38.574 visualizações

11 DE DEZEMBRO DE 2020

😊 Adicione um comentário... **Publicar**

<https://www.instagram.com/p/Clq02H8lcyT/>

maisgoias • Seguindo

maisgoias Tempo: Situação na BR-153, nas proximidades do posto Bandeirantes.

11 sem

+ Adicione um comentário...

gyslyanecosta Os carros são como as lanchas 🤔

11 sem 2 curtidas Responder

jacquemendesc @gustavorm16

11 sem 1 curtida Responder

jaine_soares5 Vichiiii 🌧️🌧️

27.245 visualizações

11 DE DEZEMBRO DE 2020

Adicione um comentário... **Publicar**

<https://www.instagram.com/p/Cltl9volmPU/>

maisgoias • Seguindo

Áudio original

maisgoias Um motociclista foi arrastado pela enxurrada após a forte chuva que caiu na tarde deste sábado na cidade de Nerópolis. O caso aconteceu na Rua Antônio de Bastos, no Setor Alto da Boa Vista. O homem foi socorrido por um rapaz que passava pelo local. Apesar do susto, o motociclista não ficou ferido. Vídeo @adriano.ramalho

11 sem

+ Adicione um comentário...

mariajoana1407 🍌

11 com Responder

Curtido por camiloaraujoegito e outras 18.838 pessoas

12 DE DEZEMBRO DE 2020

Adicione um comentário... **Publicar**

10. Laudo Técnico

CLIMATEMPO

**Laudo Meteorológico de Evento Climático -
ENEL Goiás - 06 de dezembro de 2020**

São Paulo, SP, Brasil

Janeiro de 2021

Sumário

1	ANÁLISE DE EVENTO METEOROLÓGICO.....	2
1.1	Descrição do Evento.....	2
1.2	Abrangência do Evento.....	7
2	CLASSIFICAÇÃO COBRADE.....	16
3	RESUMO DO EVENTO.....	17
4	REFERÊNCIAS.....	20
	ANEXOS.....	21

1. Análise de Evento Meteorológico

1.1. Descrição do Evento

Na figura a seguir é apresentada a área de concessão da ENEL DISTRIBUIÇÃO GOIÁS, dividida em regiões, a serem analisadas neste relatório.



Figura 1 – Regiões atendidas pela ENEL Goiás.

A formação e manutenção de uma Zona de Convergência do Atlântico Sul (ZCAS) favoreceu a organização de áreas de instabilidade sobre o estado de Goiás entre os dias 06 e 12 de dezembro de 2020.

Nas Figuras 2 e 3 são apresentadas as descargas atmosféricas nuvem-solo (raios) e nuvem-nuvem detectadas pelo sistema Earth Networks. Entre as 09h45 do dia 06 e 00h20 do dia 13 de dezembro de 2020 foram registrados 73377 raios nuvem-solo e 234196 descargas nuvem-nuvem sobre a área da ENEL DISTRIBUIÇÃO GOIÁS.

Na tabela 1 são apresentadas as rajadas de vento de 50 km/h ou mais registradas por estações do Instituto Nacional de Meteorologia (INMET) representativas da área de concessão da ENEL GO. O maior valor registrado foi de 91,1 km/h em Alto Araguaia entre as 16h e 17h do dia 09 de dezembro, vento classificado como tempestade pela escala Beaufort.

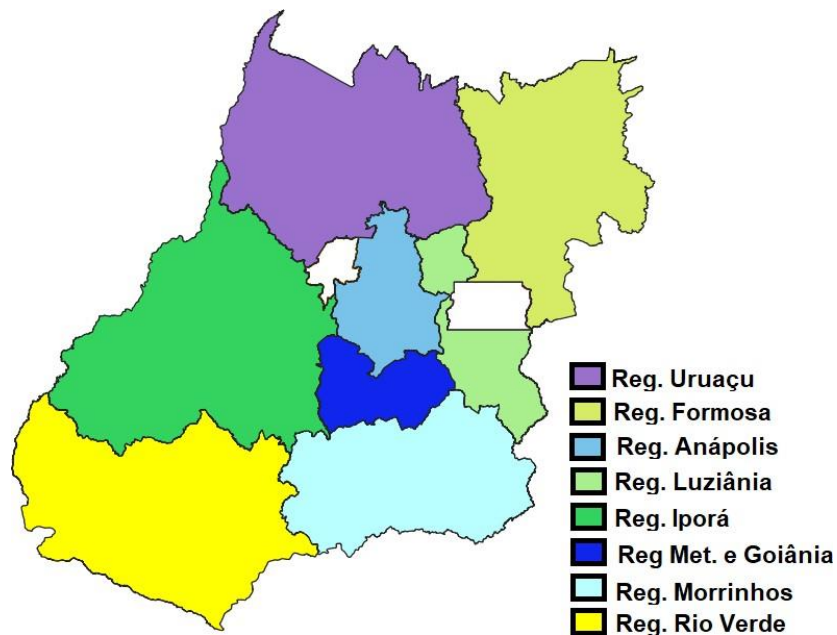

Figura 2 – Descargas atmosféricas nuvem-solo (em preto) detectadas pelo sistema Earth Networks entre 09h45 do dia 06 e 00h20 do dia 13 de dezembro de 2020 sobre a área de concessão da ENEL DISTRIBUIÇÃO GOIÁS.



Figura 3 – Descargas atmosféricas nuvem-nuvem (em vermelho) detectadas pelo sistema Earth Networks entre 09h45 do dia 06 e 00h20 do dia 13 de dezembro de 2020 sobre a área de concessão da ENEL DISTRIBUIÇÃO GOIÁS.

Tabela 1 – Rajadas de vento maiores ou iguais a 50 km/h registradas pelo INMET. Segundo a escala Beaufort, ventos entre 50 e 61 km/h são classificados como vento forte e entre 62 e 74 km/h como ventania, entre 75 e 88 km/h como ventania forte e entre 89 e 102 km/h como tempestade

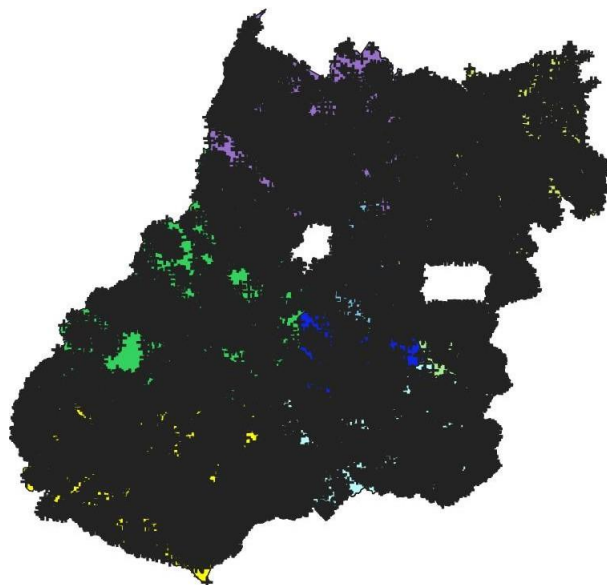
Estação	Horário	Rajada (km/h)
Caipônia	Entre 13h e 14h do dia 6/12/2020	65.5
Monte Alegre de Goiás	Entre 15h e 16h do dia 6/12/2020	52.6
Mineiros	Entre 16h e 17h do dia 6/12/2020	56.9
Monte Alegre de Goiás	Entre 16h e 17h do dia 6/12/2020	56.5
Mineiros	Entre 17h e 18h do dia 6/12/2020	63.4
Pires do Rio	Entre 15h e 16h do dia 8/12/2020	53.6
Goiás	Entre 17h e 18h do dia 8/12/2020	56.2
Alto Araguaia	Entre 16h e 17h do dia 9/12/2020	91.1
Alto Araguaia	Entre 17h e 18h do dia 9/12/2020	54.4
Monte Alegre de Goiás	Entre 17h e 18h do dia 10/12/2020	50.0
Pires do Rio	Entre 14h e 15h do dia 11/12/2020	55.8

As estações do INMET também registraram chuva forte (segundo a American Meteorological Society - Sociedade Meteorológica Americana -, chuvas com taxa entre 2,5mm a 7,6 mm por hora são consideradas moderadas e aquelas com taxa superior a 7,6 mm por hora são consideradas chuva forte). Na tabela 2 são apresentados os registros de acumulados horários superiores a 7,6 mm.

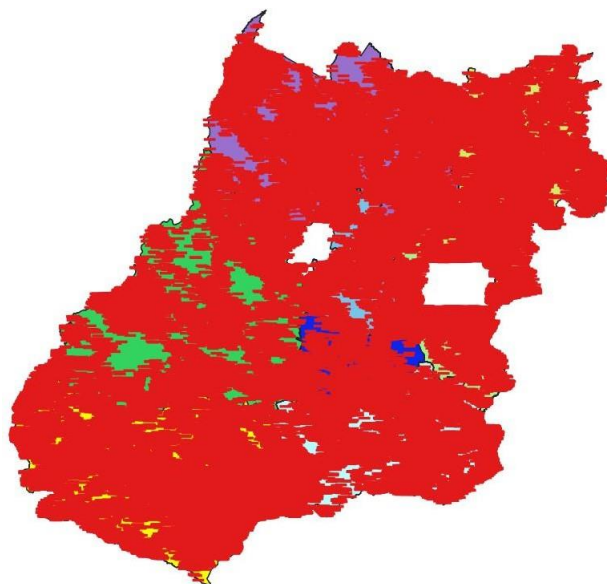
Tabela 2 – Acumulado horário de chuva registrada pelo INMET.

Estação	Horário	Precipitação (mm)
Itapaci	Entre 15h e 16h do dia 6/12/2020	15.4
Jataí	Entre 19h e 20h do dia 6/12/2020	15.6
Morrinhos	Entre 23h e 0h do dia 7/12/2020	13.6
Paraúna	Entre 0h e 1h do dia 7/12/2020	8.2
Alto Araguaia	Entre 16h e 17h do dia 7/12/2020	12.6
Monte Alegre de Goiás	Entre 6h e 7h do dia 8/12/2020	12.2
Goiás	Entre 17h e 18h do dia 8/12/2020	9.2
Paraúna	Entre 19h e 20h do dia 8/12/2020	51.4
Catalão	Entre 0h e 1h do dia 9/12/2020	36.0
Catalão	Entre 1h e 2h do dia 9/12/2020	25.8
Itumbiara	Entre 13h e 14h do dia 9/12/2020	16.6
Posse	Entre 14h e 15h do dia 9/12/2020	56.2
Posse	Entre 15h e 16h do dia 9/12/2020	9.0
Alto Araguaia	Entre 16h e 17h do dia 9/12/2020	15.6
Jataí	Entre 18h e 19h do dia 9/12/2020	12.4
Cristalina	Entre 21h e 22h do dia 9/12/2020	11.4
Monte Alegre de Goiás	Entre 13h e 14h do dia 10/12/2020	12.6
Cristalina	Entre 20h e 21h do dia 10/12/2020	28.6
Jataí	Entre 22h e 23h do dia 10/12/2020	41.8
Catalão	Entre 8h e 9h do dia 11/12/2020	17.2
Goiânia	Entre 14h e 15h do dia 11/12/2020	7.8
Mineiros	Entre 14h e 15h do dia 11/12/2020	15.6
Pires do Rio	Entre 14h e 15h do dia 11/12/2020	15.6
Goiânia	Entre 15h e 16h do dia 11/12/2020	18.6
Alto Paraíso de Goiás	Entre 17h e 18h do dia 11/12/2020	13.4
Monte Alegre de Goiás	Entre 17h e 18h do dia 11/12/2020	26.6
Alto Araguaia	Entre 15h e 16h do dia 12/12/2020	13.0
Goiás	Entre 15h e 16h do dia 12/12/2020	10.6
Pires do Rio	Entre 15h e 16h do dia 12/12/2020	12.6
Itumbiara	Entre 17h e 18h do dia 12/12/2020	8.8
Morrinhos	Entre 19h e 20h do dia 12/12/2020	11.8

Nas tabelas a seguir são apresentados os maiores acumulados em 24 horas registrados pelo INMET. O maior valor registrado durante o evento analisado foi entre a manhã do dia 08 e a manhã do dia 09 de dezembro, com total de 85,4 mm em Catalão, volume que corresponde a aproximadamente 31% da média climatológica para o mês na região.

Tabela 3 – Precipitação acumulada entre 09h do dia 06 e 09h do dia 07 de dezembro de 2020. FONTE: INMET

Estação	Precipitação Acumulada(mm)
FORMOSA	68.0
MORRINHOS	33.0
JATAI	30.0

Tabela 4 – Precipitação acumulada entre 09h do dia 08 e 09h do dia 09 de dezembro de 2020. FONTE: INMET

Estação	Precipitação Acumulada(mm)
CATALAO	85.4
PARAUNA	59.8

Tabela 5 – Precipitação acumulada entre 09h do dia 09 e 09h do dia 10 de dezembro de 2020. FONTE: INMET

Estação	Precipitação Acumulada(mm)
POSSE	74.4
IPAMERI	43.0
CRISTALINA (FAZENDA SANTA MÔNICA)	35.0

Tabela 6 – Precipitação acumulada entre 09h do dia 10 e 09h do dia 11 de dezembro de 2020. FONTE: INMET

Estação	Precipitação Acumulada(mm)
JATAI	59.0
CRISTALINA	35.4
EDEIA	33.4

Tabela 7 – Precipitação acumulada entre 09h do dia 11 e 09h do dia 12 de dezembro de 2020. FONTE: INMET

Estação	Precipitação Acumulada(mm)
GOIÁS	39.6
MONTE ALEGRE DE GOIAS	32.2
MINEIROS	32.0

Tabela 8 – Precipitação acumulada entre 09h do dia 12 e 09h do dia 13 de dezembro de 2020. FONTE: INMET

Estação	Precipitação Acumulada(mm)
GOIANIA	30.0

1.2. Abrangência do Evento

A seguir são apresentadas as imagens realçadas do satélite GOES-16 entre as 15h00 do dia 06 e 03h00 do dia 13 de dezembro de 2020. Os tons em vermelho, preto e rosa indicam a presença de nuvens de grande desenvolvimento vertical, geralmente associadas à ocorrência de tempo severo.

15h00 - 06 de Dezembro de 2020 - BRT



Figura 4 – Imagens realçadas do satélite GOES-16 das 15h00 do dia 06 de Dezembro de 2020.
FONTE: Cptec/INPE.

21h00 - 06 de Dezembro de 2020 - BRT

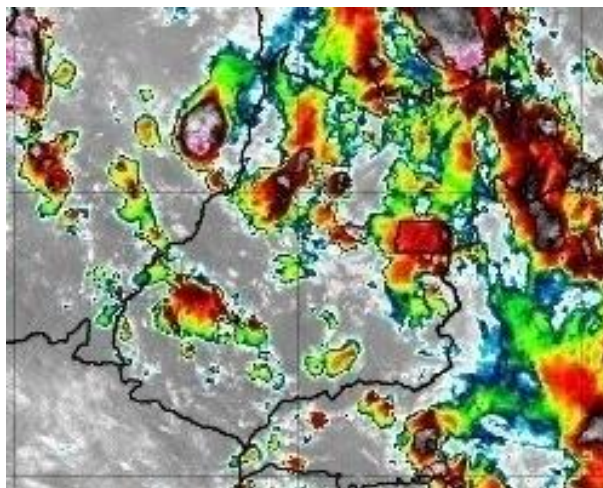

Figura 5 – Imagens realçadas do satélite GOES-16 das 21h00 do dia 06 de Dezembro de 2020.
FONTE: Cptec/INPE.

3h00 - 07 de Dezembro de 2020 - BRT

Figura 6 – Imagens realçadas do satélite GOES-16 das 3h00 do dia 07 de Dezembro de2020.
FONTE: Cptec/INPE.

12h00 - 07 de Dezembro de 2020 - BRT

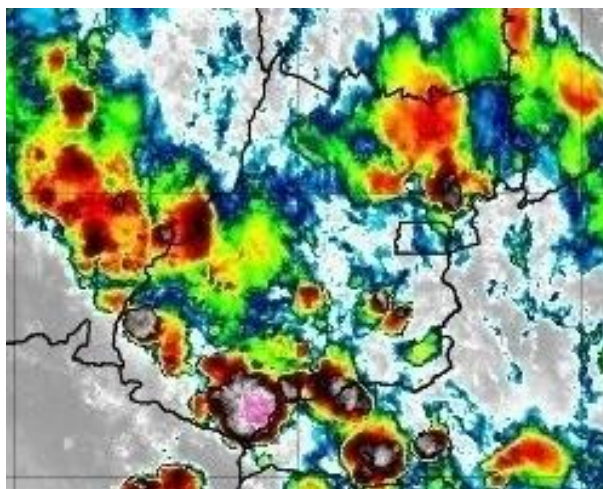
Figura 7 – Imagens realçadas do satélite GOES-16 das 12h00 do dia 07 de Dezembro de2020.
FONTE: Cptec/INPE.

21h00 - 07 de Dezembro de 2020 - BRT

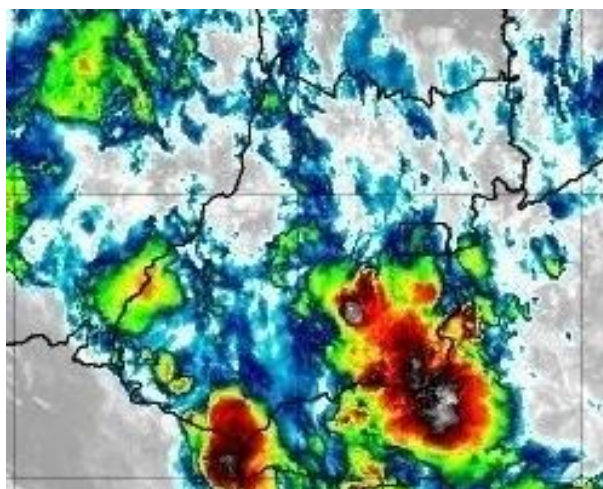
Figura 8 – Imagens realçadas do satélite GOES-16 das 21h00 do dia 07 de Dezembro de2020.
FONTE: Cptec/INPE.

3h00 - 08 de Dezembro de 2020 - BRT

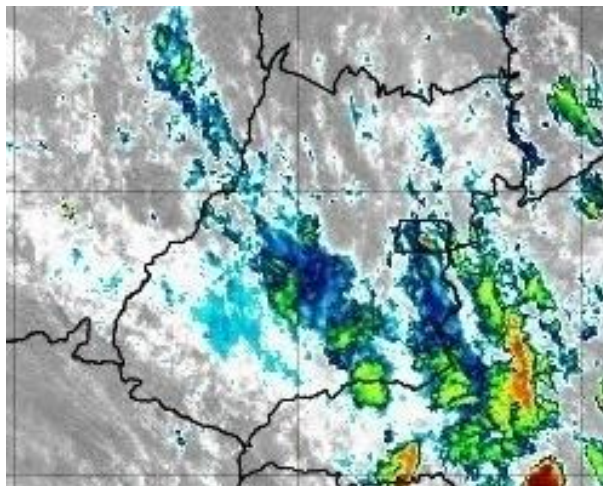
Figura 9 – Imagens realçadas do satélite GOES-16 das 3h00 do dia 08 de Dezembro de2020.
FONTE: Cptec/INPE.

9h00 - 08 de Dezembro de 2020 - BRT

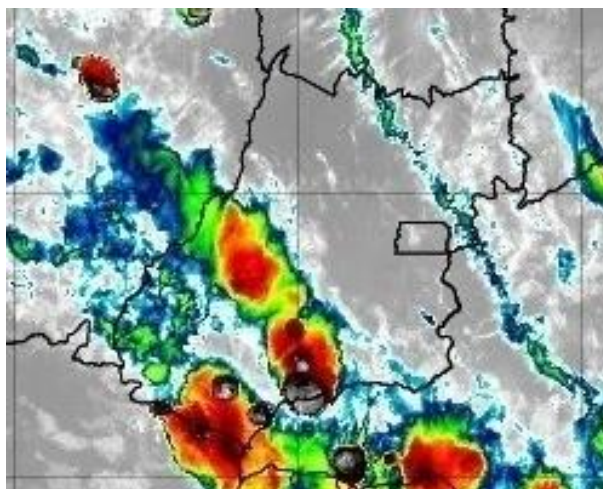
Figura 10 – Imagens realçadas do satélite GOES-16 das 9h00 do dia 08 de Dezembro de2020.
FONTE: Cptec/INPE.

15h00 - 08 de Dezembro de 2020 - BRT

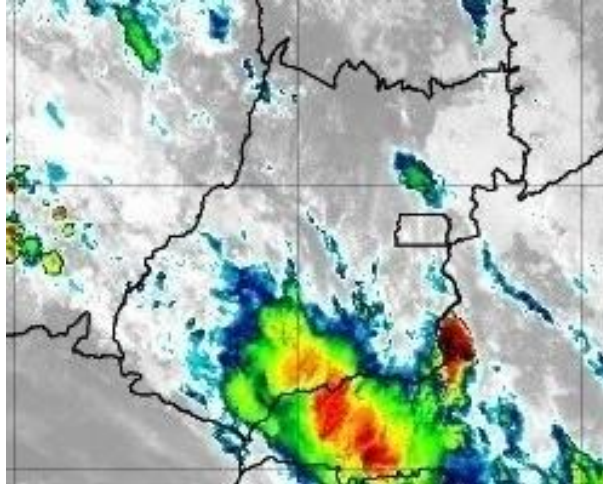
Figura 11 – Imagens realçadas do satélite GOES-16 das 15h00 do dia 08 de Dezembro de2020.
FONTE: Cptec/INPE.

21h00 - 08 de Dezembro de 2020 - BRT

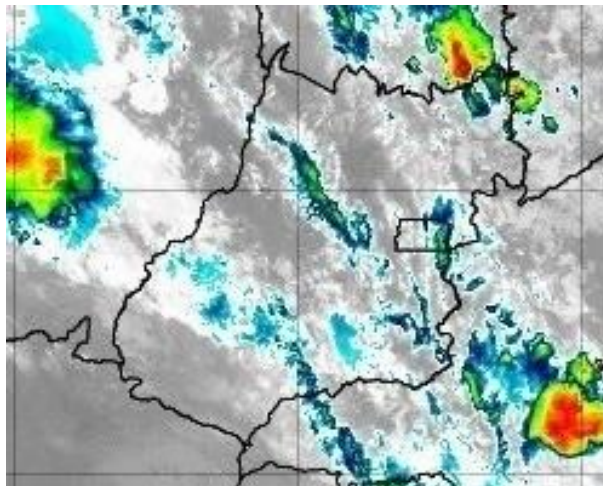
Figura 12 – Imagens realçadas do satélite GOES-16 das 21h00 do dia 08 de Dezembro de 2020.
FONTE: Cptec/INPE.

3h00 - 09 de Dezembro de 2020 - BRT

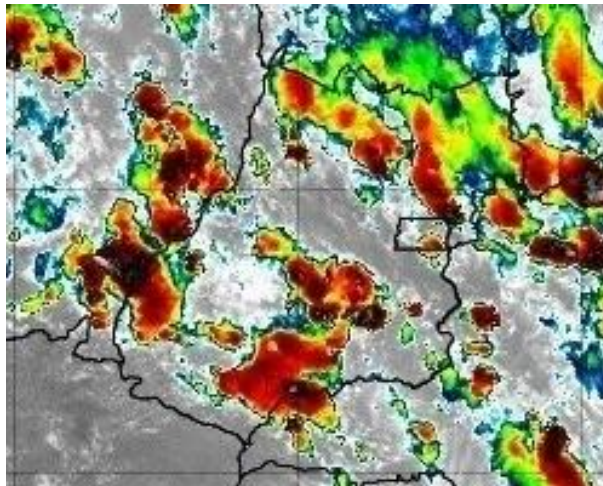
Figura 13 – Imagens realçadas do satélite GOES-16 das 3h00 do dia 09 de Dezembro de 2020.
FONTE: Cptec/INPE.

9h00 - 09 de Dezembro de 2020 - BRT

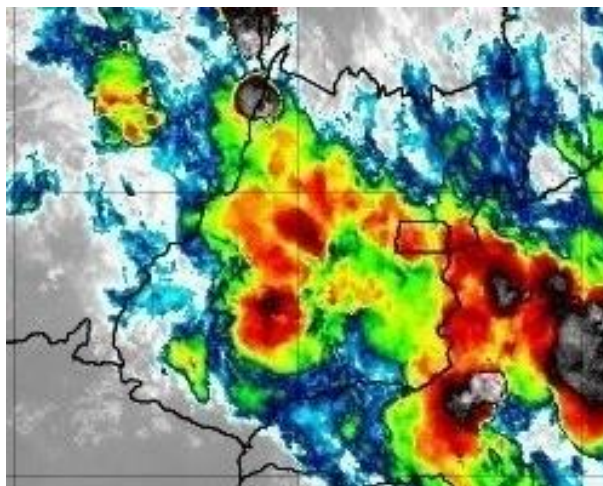
Figura 14 – Imagens realçadas do satélite GOES-16 das 9h00 do dia 09 de Dezembro de 2020.
FONTE: Cptec/INPE.

15h00 - 09 de Dezembro de 2020 - BRT

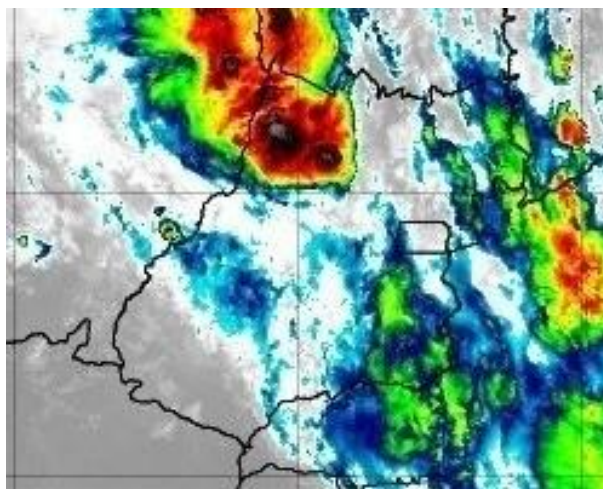
Figura 15 – Imagens realçadas do satélite GOES-16 das 15h00 do dia 09 de Dezembro de2020.
FONTE: Cptec/INPE.

21h00 - 9 de Dezembro de 2020 - BRT

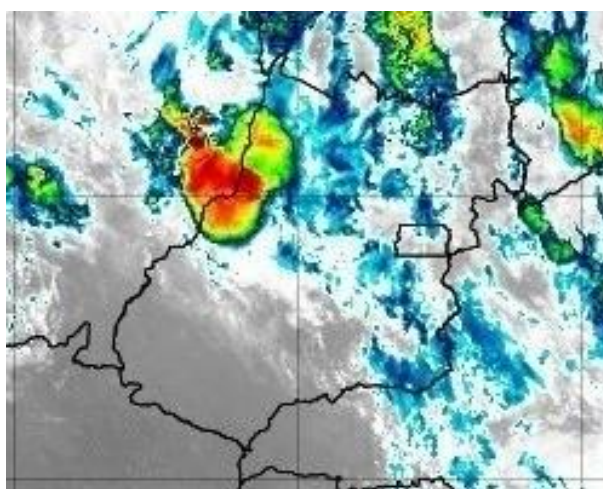
Figura 16 – Imagens realçadas do satélite GOES-16 das 21h00 do dia 9 de Dezembro de2020.
FONTE: Cptec/INPE.

3h00 - 10 de Dezembro de 2020 - BRT

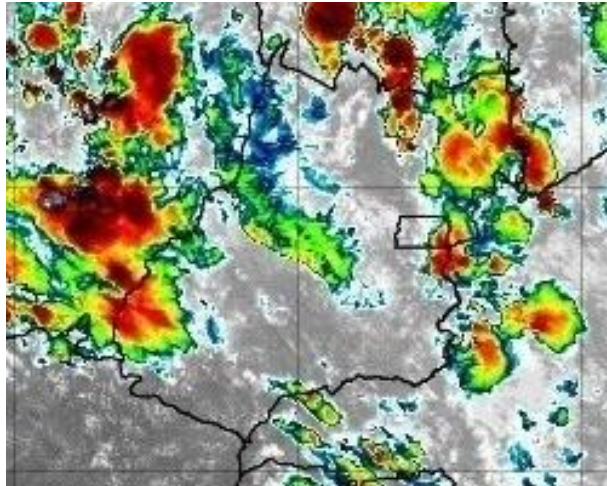
Figura 17 – Imagens realçadas do satélite GOES-16 das 3h00 do dia 10 de Dezembro de2020.
FONTE: Cptec/INPE.

9h00 - 10 de Dezembro de 2020 - BRT

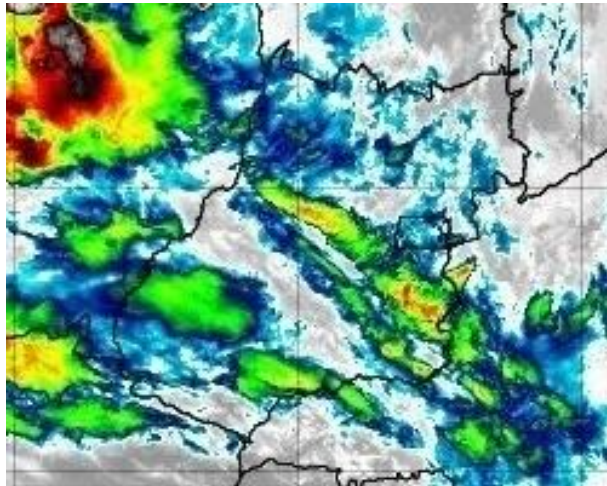
Figura 18 – Imagens realçadas do satélite GOES-16 das 9h00 do dia 10 de Dezembro de2020.
FONTE: Cptec/INPE.

15h00 - 10 de Dezembro de 2020 - BRT

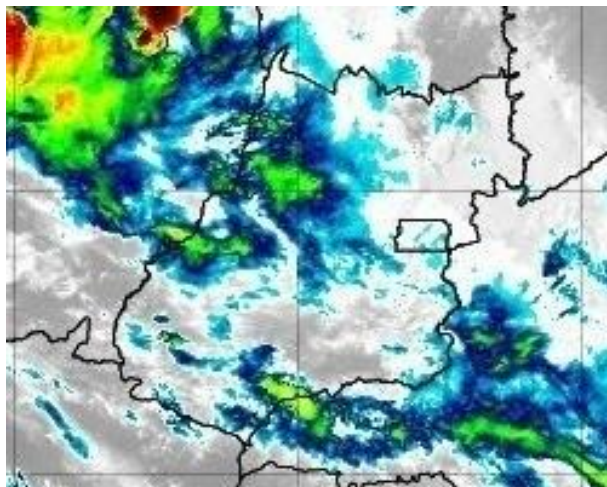
Figura 19 – Imagens realçadas do satélite GOES-16 das 15h00 do dia 10 de Dezembro de2020.
FONTE: Cptec/INPE.

21h00 - 10 de Dezembro de 2020 - BRT

Figura 20 – Imagens realçadas do satélite GOES-16 das 21h00 do dia 10 de Dezembro de2020.
FONTE: Cptec/INPE.

3h00 - 11 de Dezembro de 2020 - BRT

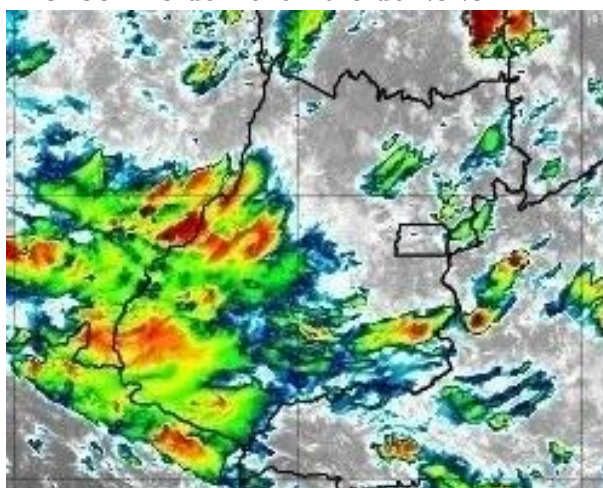
Figura 21 – Imagens realçadas do satélite GOES-16 das 3h00 do dia 11 de Dezembro de2020.
FONTE: Cptec/INPE.

9h00 - 11 de Dezembro de 2020 - BRT

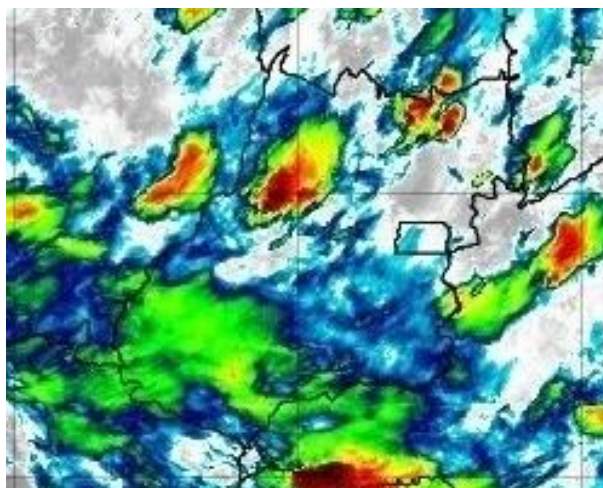
Figura 22 – Imagens realçadas do satélite GOES-16 das 9h00 do dia 11 de Dezembro de2020.
FONTE: Cptec/INPE.

15h00 - 11 de Dezembro de 2020 - BRT

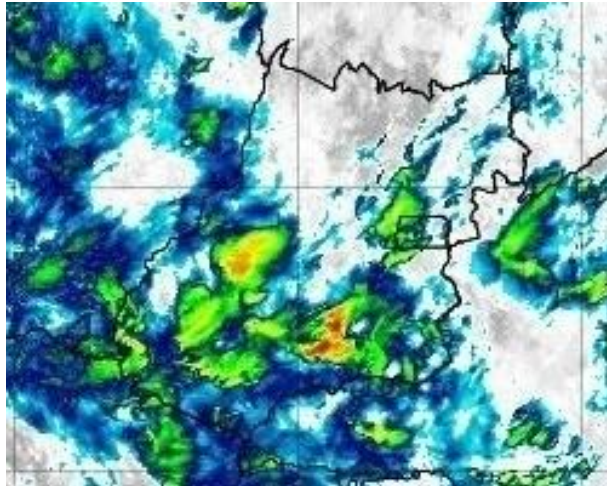
Figura 23 – Imagens realçadas do satélite GOES-16 das 15h00 do dia 11 de Dezembro de2020.
FONTE: Cptec/INPE.

21h00 - 11 de Dezembro de 2020 - BRT

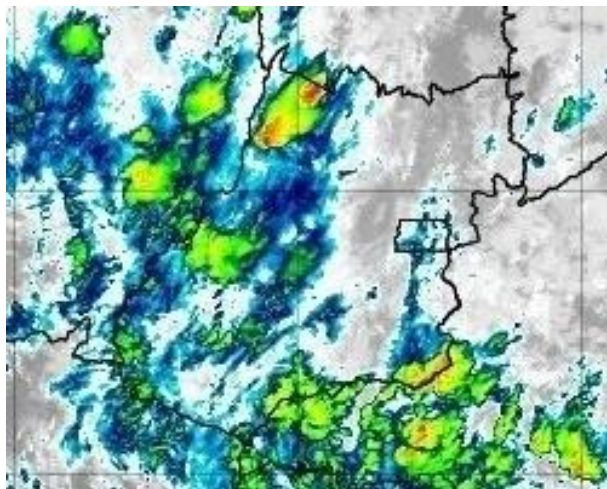
Figura 24 – Imagens realçadas do satélite GOES-16 das 21h00 do dia 11 de Dezembro de2020.
FONTE: Cptec/INPE.

3h00 - 12 de Dezembro de 2020 - BRT

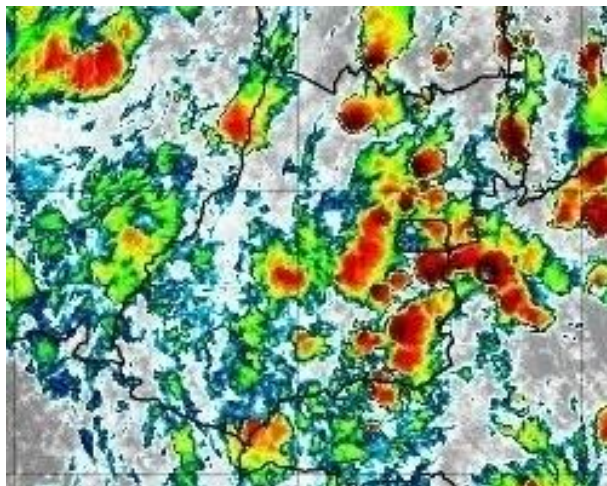
Figura 25 – Imagens realçadas do satélite GOES-16 das 3h00 do dia 12 de Dezembro de2020.
FONTE: Cptec/INPE.

9h00 - 12 de Dezembro de 2020 - BRT

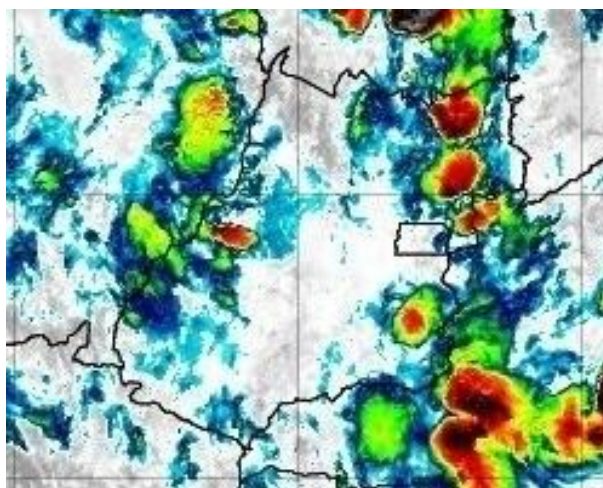
Figura 26 – Imagens realçadas do satélite GOES-16 das 9h00 do dia 12 de Dezembro de2020.
FONTE: Cptec/INPE.

15h00 - 12 de Dezembro de 2020 - BRT

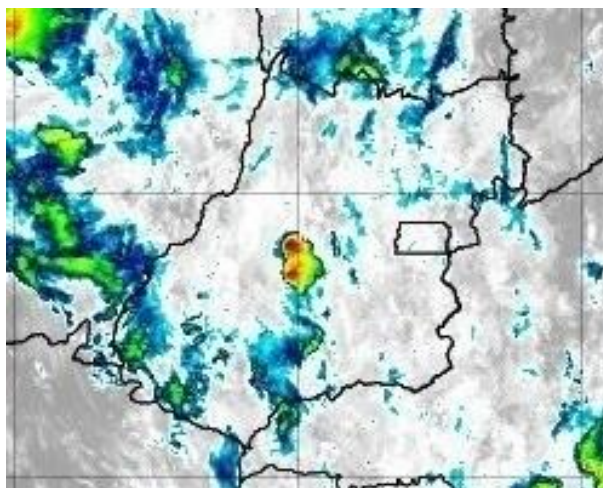
Figura 27 – Imagens realçadas do satélite GOES-16 das 15h00 do dia 12 de Dezembro de2020.
FONTE: Cptec/INPE.

21h00 - 12 de Dezembro de 2020 - BRT

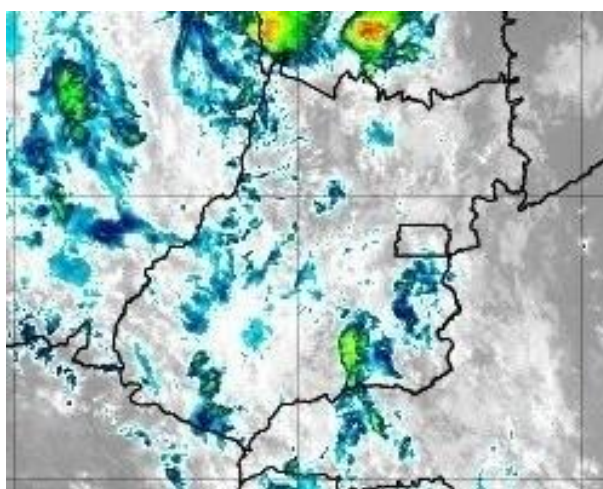
Figura 28 – Imagens realçadas do satélite GOES-16 das 21h00 do dia 12 de Dezembro de2020.
FONTE: Cptec/INPE.

3h00 - 13 de Dezembro de 2020 - BRT

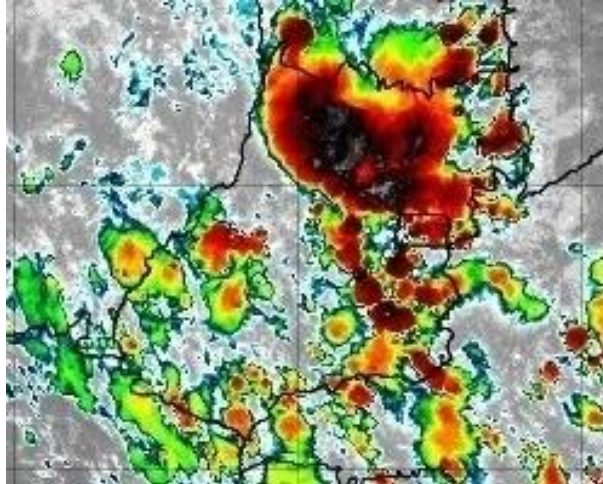
Figura 29 – Imagens realçadas do satélite GOES-16 das 3h00 do dia 13 de Dezembro de2020.
FONTE: Cptec/INPE.

2. Classificação COBRADE

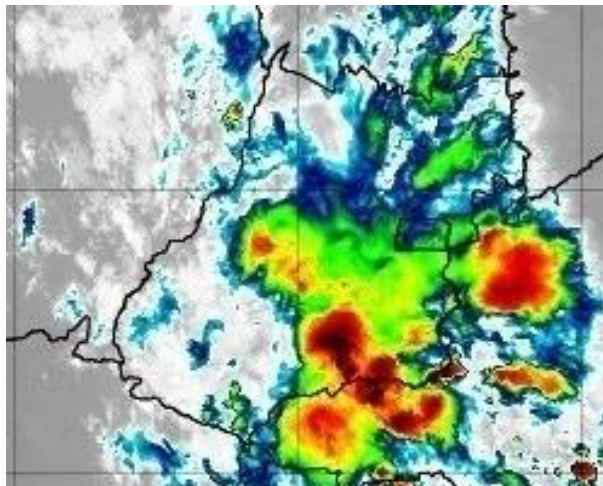
O COBRADE (Classificação e Codificação Brasileira de Desastres) foi criado como intuito de adequar a classificação brasileira à classificação utilizada pela ONU na classificação de desastres e nivelar o país aos demais organismos de gestão de desastres do mundo.

Baseados nos dados analisados nos itens anteriores, podemos classificar o evento ocorrido sobre a área de concessão da ENEL DISTRIBUIÇÃO GOIÁS como Zona de Convergência (Código 1.3.1.2.0).

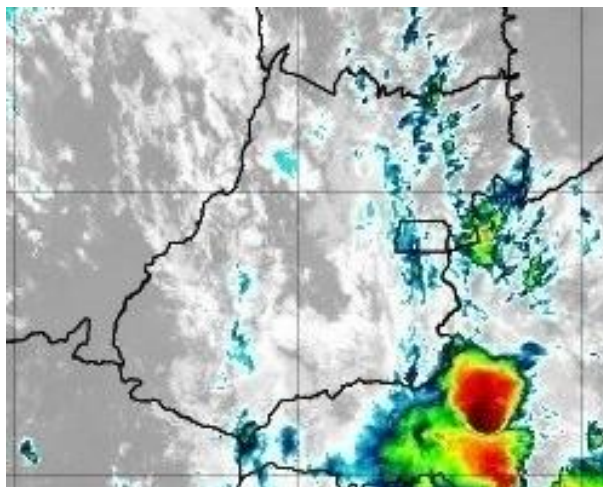
3. Resumo do Evento

Áreas de instabilidade associadas a presença de uma ZCAS favoreceram a formação de nuvens de tempestade sobre o estado de Goiás entre a manhã do dia 06 e a madrugada do dia 13 de dezembro de 2020.

O sistema de detecção da Earth Networks registrou 307573 descargas atmosféricas sobre a área de concessão da ENEL em Goiás entre as 09h45 do dia 06 e 00h20 do dia 13 de dezembro de 2020.

Rajadas de vento classificadas como vento forte, ventania e tempestade pela escala Beaufort foram registrados em estações do INMET representativas da região durante o período. Na cidade de Alta Araguaia rajadas de até 91,1 km/h foram registradas na tarde do dia 09 de dezembro.

Chuva forte e significativa também foi registrada pelo INMET durante o evento. Em Catalão, entre os dias 08 e 09 de dezembro, foi acumulado o equivalente a 31% da média climatológica do mês.

Tabela 9 – Resumo do evento Regional Rio Verde

Número/Código do Evento	
Número/Código do Relatório	
Descrição	Região ligada à tempestade causada por uma zona de baixa pressão atmosférica, provocando forte deslocamento de massas de ar, vendavais, chuvas intensas e possível queda de granizo.
Código COBRADE	1.3.1.2.0 – Zona de Convergência
Hora início do evento	12h30 do dia 06 de dezembro de 2020
Hora fim do evento	21h00 do dia 12 de dezembro de 2020
Abrangência	Regional Rio Verde

Tabela 10 – Resumo do evento Regional Morrinhos

Número/Código do Evento	
Número/Código do Relatório	
Descrição	Região ligada à tempestade causada por uma zona de baixa pressão atmosférica, provocando forte deslocamento de massas de ar, vendavais, chuvas intensas e possível queda de granizo.
Código COBRADE	1.3.1.2.0 – Zona de Convergência
Hora início do evento	11h30 do dia 06 de dezembro de 2020
Hora de fim do evento	01h00 do dia 13 de dezembro de 2020
Abrangência	Regional Morrinhos

Tabela 11 – Resumo do evento Regional Metropolitana e Goiânia

Número/Código do Evento	
Número/Código do Relatório	
Descrição	Região ligada à tempestade causada por uma zona de baixa pressão atmosférica, provocando forte deslocamento de massas de ar, vendavais, chuvas intensas e possível queda de granizo.
Código COBRADE	1.3.1.2.0 – Zona de Convergência
Hora início do evento	13h00 do dia 06 de dezembro de 2020
Hora de fim do evento	21h00 do dia 12 de dezembro de 2020
Abrangência	Regional Metropolitana e Goiânia

Tabela 12 – Resumo do evento Regional Iporá

Número/Código do Evento	
Número/Código do Relatório	
Descrição	Região ligada à tempestade causada por uma zona de baixa pressão atmosférica, provocando forte deslocamento de massas de ar, vendavais, chuvas intensas e possível queda de granizo.
Código COBRADE	1.3.1.2.0 – Zona de Convergência
Hora início do evento	12h00 do dia 06 de dezembro de 2020
Hora de fim do evento	20h00 do dia 12 de dezembro de 2020
Abrangência	Regional Iporá

Tabela 13 – Resumo do evento Regional Luziânia

Número/Código do Evento	
Número/Código do Relatório	
Descrição	Região ligada à tempestade causada por uma zona de baixa pressão atmosférica, provocando forte deslocamento de massas de ar, vendavais, chuvas intensas e possível queda de granizo.
Código COBRADE	1.3.1.2.0 – Zona de Convergência
Hora início do evento	11h00 do dia 06 de dezembro de 2020
Hora de fim do evento	22h00 do dia 12 de dezembro de 2020
Abrangência	Regional Luziânia

Tabela 14 – Resumo do evento Regional Anápolis

Número/Código do Evento	
Número/Código do Relatório	
Descrição	Região ligada à tempestade causada por uma zona de baixa pressão atmosférica, provocando forte deslocamento de massas de ar, vendavais, chuvas intensas e possível queda de granizo.
Código COBRADE	1.3.1.2.0 – Zona de Convergência
Hora início do evento	12h00 do dia 06 de dezembro de 2020
Hora de fim do evento	19h00 do dia 12 de dezembro de 2020
Abrangência	Regional Anápolis

Tabela 15 – Resumo do evento Regional Uruaçu

Número/Código do Evento	
Número/Código do Relatório	
Descrição	Região ligada à tempestade causada por uma zona de baixa pressão atmosférica, provocando forte deslocamento de massas de ar, vendavais, chuvas intensas e possível queda de granizo.
Código COBRADE	1.3.1.2.0 – Zona de Convergência
Hora início do evento	09h30 do dia 06 de dezembro de 2020
Hora de fim do evento	19h30 do dia 12 de dezembro de 2020
Abrangência	Regional Uruaçu

Tabela 16 – Resumo do evento Regional Formosa

Número/Código do Evento	
Número/Código do Relatório	
Descrição	Região ligada à tempestade causada por uma zona de baixa pressão atmosférica, provocando forte deslocamento de massas de ar, vendavais, chuvas intensas e possível queda de granizo.
Código COBRADE	1.3.1.2.0 – Zona de Convergência
Hora início do evento	10h00 do dia 06 de dezembro de 2020
Hora de fim do evento	20h00 do dia 12 de dezembro de 2020
Abrangência	Regional Formosa

4. Referências

- RMets Royal Meteorological Society – Beaufort Scale -
<https://www.rmets.org/weather-and-climate/observing/beaufort-scale>
- Instituto Nacional de Meteorologia (INMET) - <http://www.inmet.gov.br>
- Cptec/INPE
<https://www.cptec.inpe.br/>
- Centro de Hidrografia da Marinha do Brasil -
<https://www.marinha.mil.br/chm/>
- Meteorology Glossary - American Meteorological Society -
<http://glossary.ametsoc.org/>

Anexos

A.1. Carta Sinótica



Figura A1 - Carta sinótica da Marinha do Brasil para as 1200Z do dia 06 de dezembro de 2020 (09h00 do dia 06 de dezembro de 2020, hora local).



LEGENDA			
	Frente Fria	A	Alta Pressão
	Frente Quente	B	Baixa Pressão
	Instabilidade		Zona de Convergência

Figura A2 - Carta sinótica da Marinha do Brasil para as 1200Z do dia 07 de dezembro de 2020 (09h00 do dia 07 de dezembro de 2020, hora local).

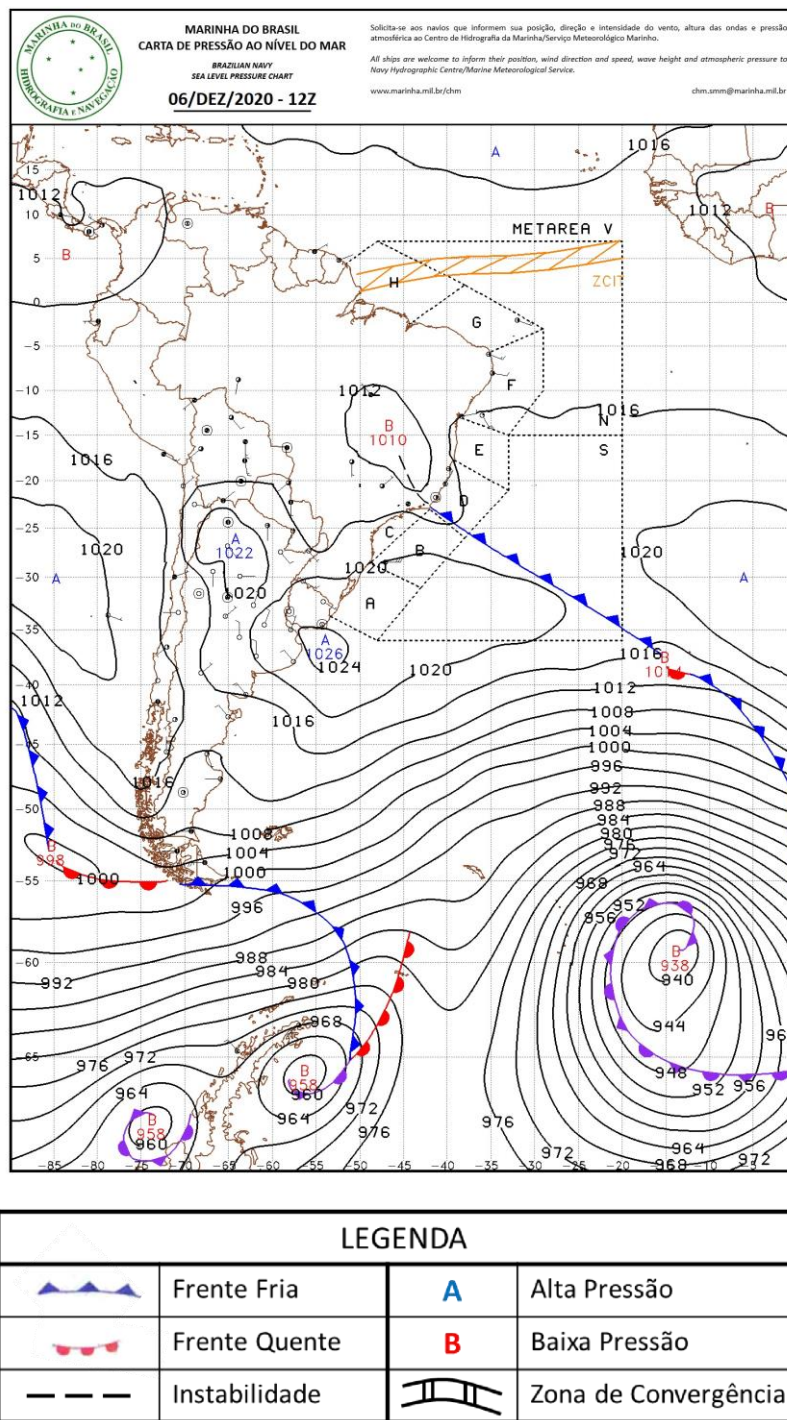
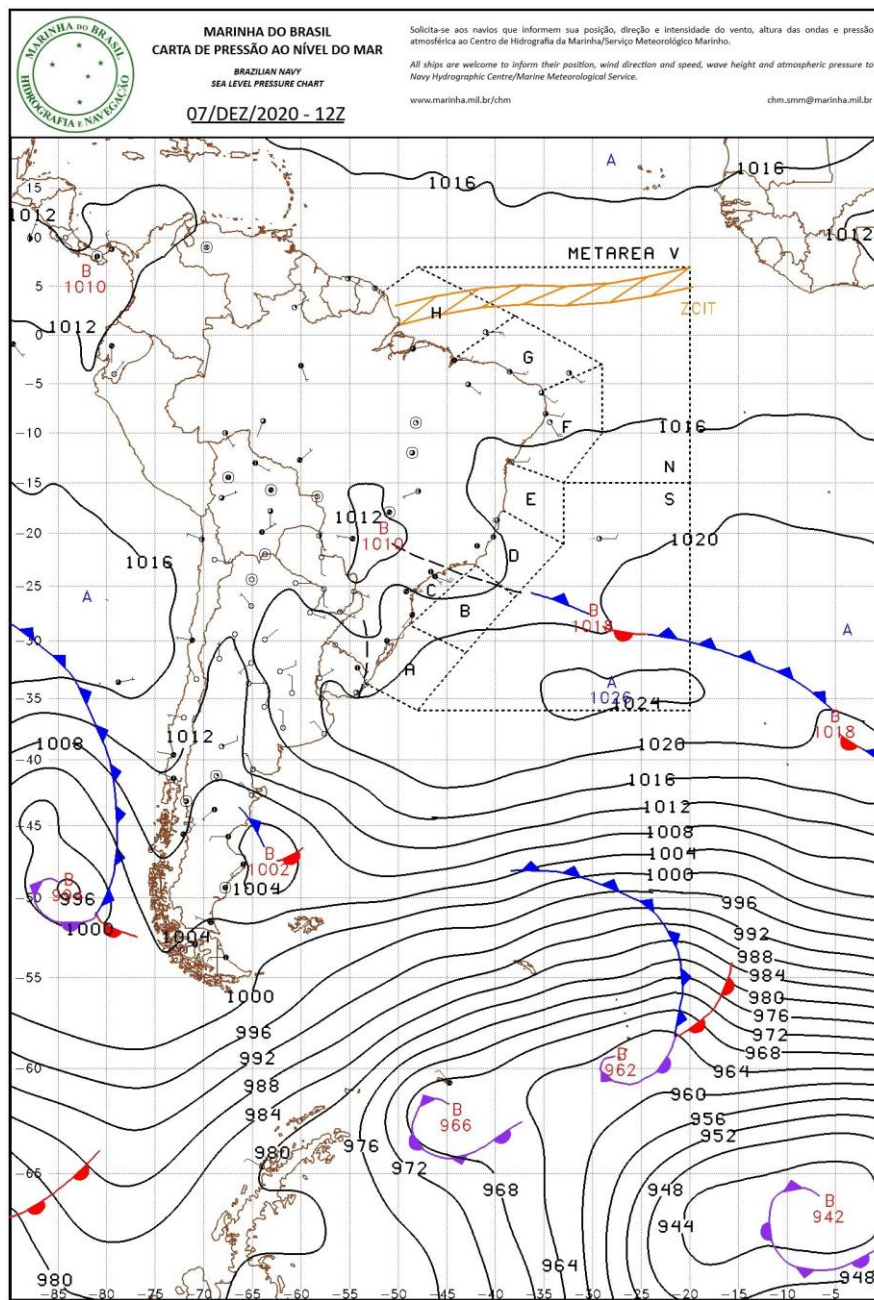
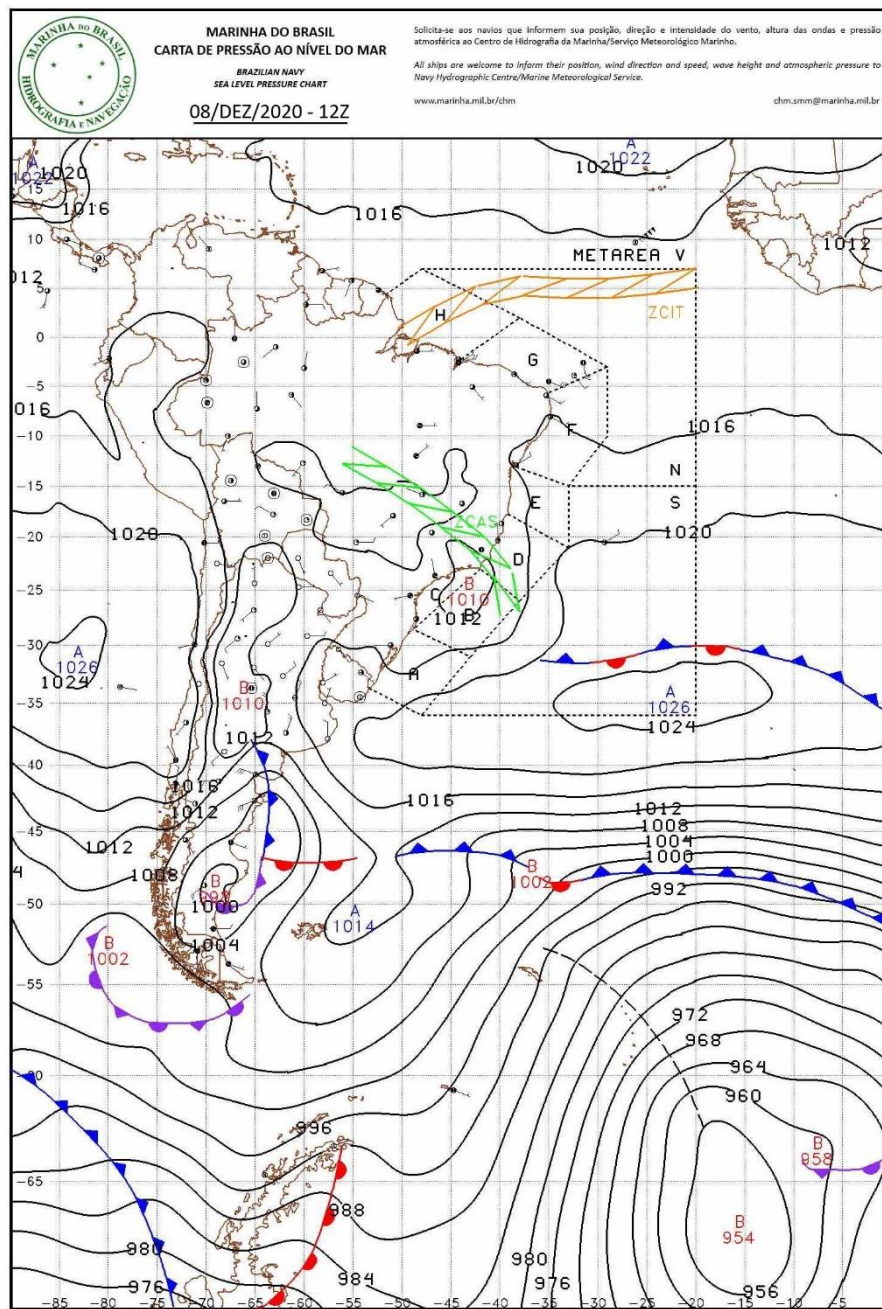

LEGENDA			
	Frente Fria	A	Alta Pressão
	Frente Quente	B	Baixa Pressão
	Instabilidade		Zona de Convergência

Figura A3 - Carta sinótica da Marinha do Brasil para as 1200Z do dia 08 de dezembro de 2020 (09h00 do dia 08 de dezembro de 2020, hora local).

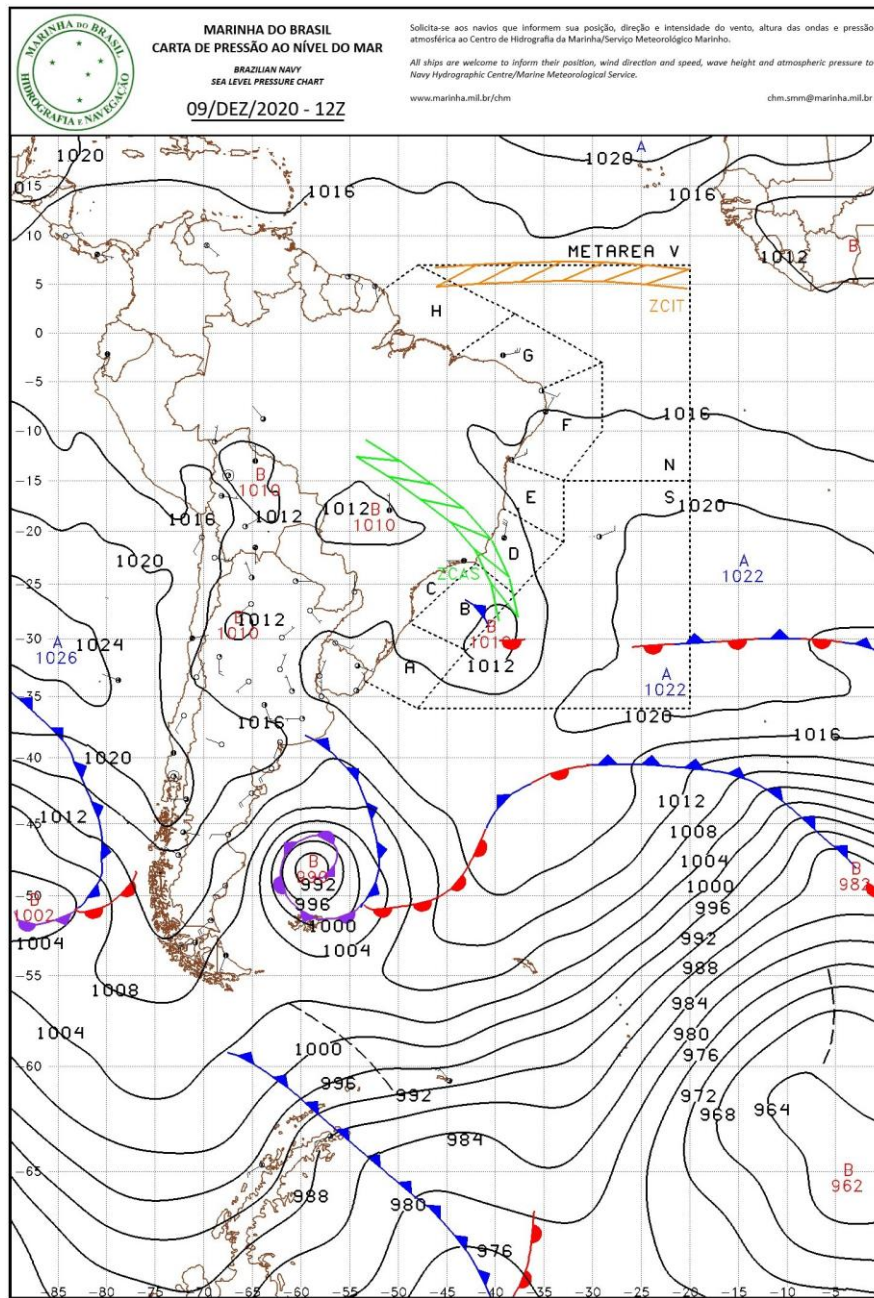

LEGENDA			
	Frente Fria	A	Alta Pressão
	Frente Quente	B	Baixa Pressão
	Instabilidade		Zona de Convergência

Figura A4 - Carta sinótica da Marinha do Brasil para as 1200Z do dia 09 de dezembro de 2020 (09h00 do dia 09 de dezembro de 2020, hora local).

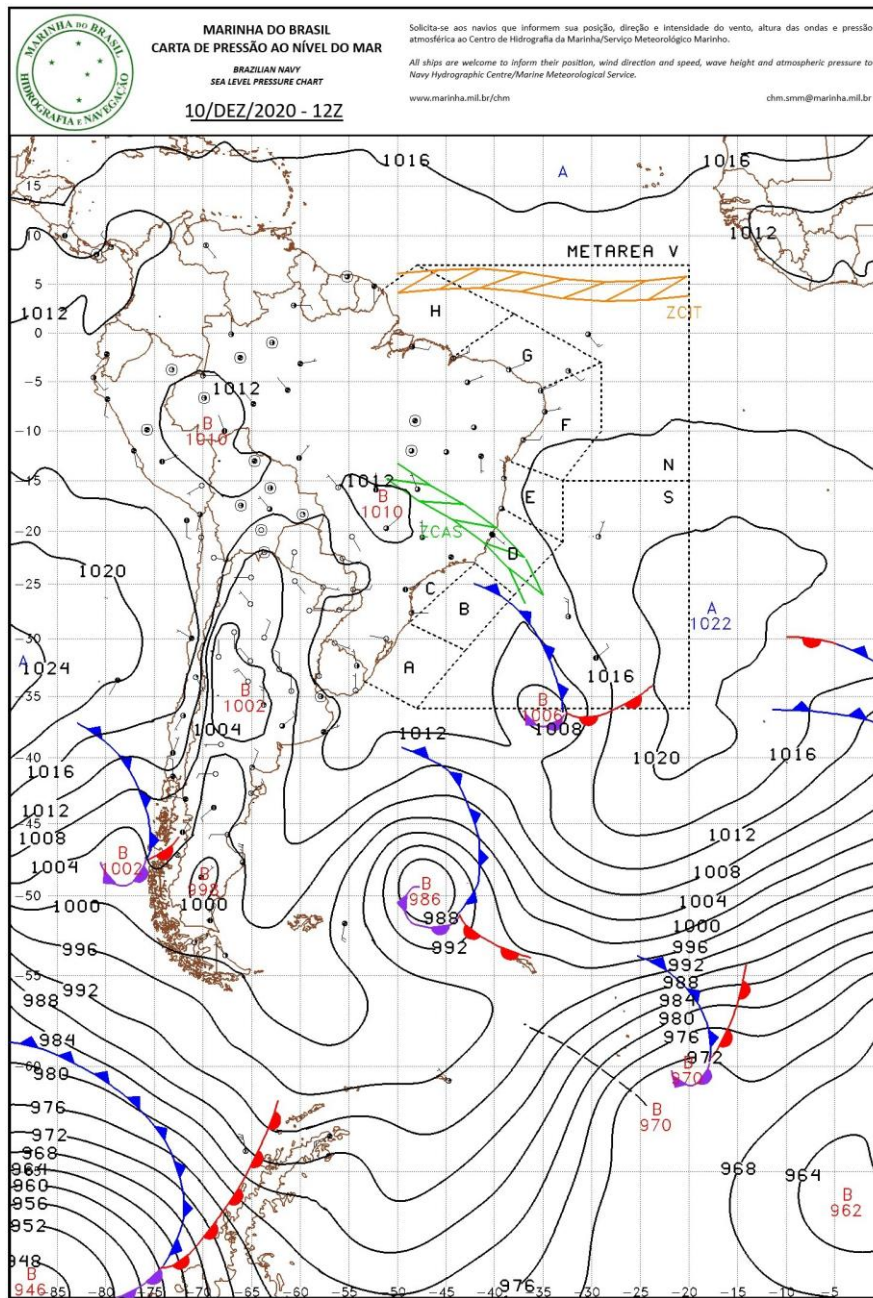

LEGENDA			
	Frente Fria	A	Alta Pressão
	Frente Quente	B	Baixa Pressão
	Instabilidade		Zona de Convergência

Figura A5 - Carta sinótica da Marinha do Brasil para as 1200Z do dia 10 de dezembro de 2020 (09h00 do dia 10 de dezembro de 2020, hora local).

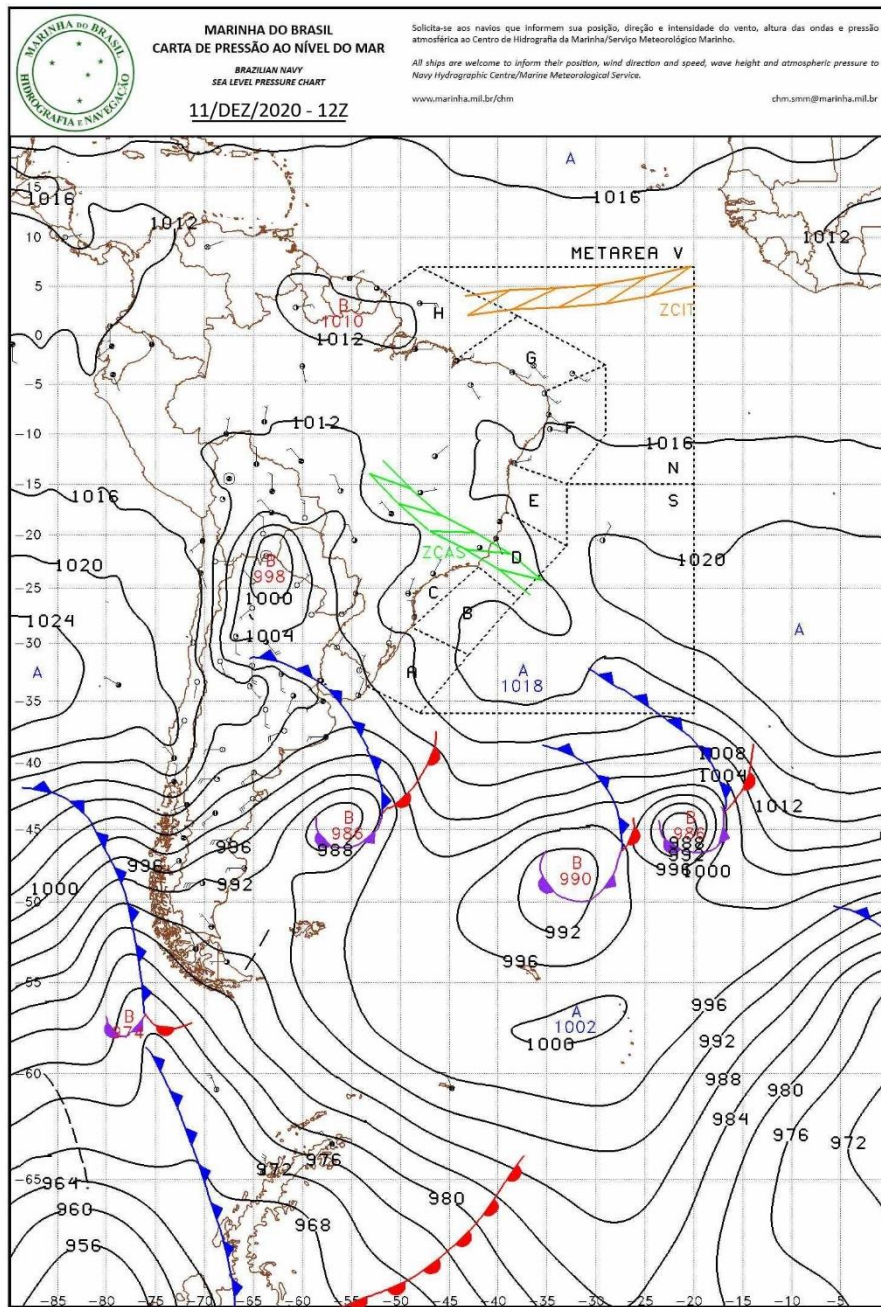

LEGENDA			
	Frente Fria	A	Alta Pressão
	Frente Quente	B	Baixa Pressão
	Instabilidade		Zona de Convergência

Figura A6 - Carta sinótica da Marinha do Brasil para as 1200Z do dia 11 de dezembro de 2020 (09h00 do dia 11 de dezembro de 2020, hora local).

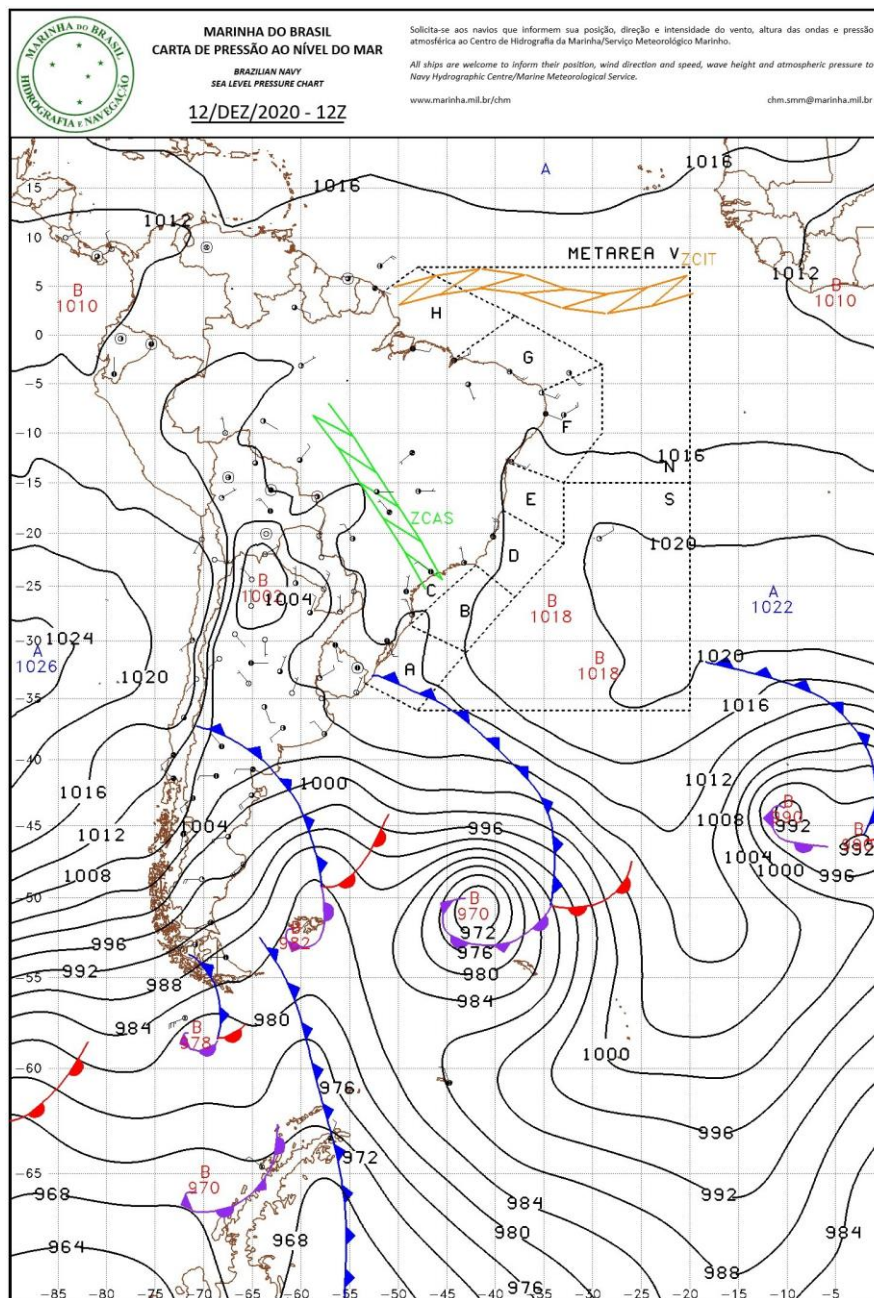

LEGENDA			
	Frente Fria	A	Alta Pressão
	Frente Quente	B	Baixa Pressão
	Instabilidade		Zona de Convergência

Figura A7 - Carta sinótica da Marinha do Brasil para as 1200Z do dia 12 de dezembro de 2020 (09h00 do dia 12 de dezembro de 2020, hora local).

A.2. Notícias associadas

- Chuva alaga ruas na Grande Goiânia
<https://globoplay.globo.com/v/9093317/>
- Chuva forte atinge Caldas Novas
<https://globoplay.globo.com/v/9086526/>
- Chuva provoca queda de árvores em Goiânia
<https://globoplay.globo.com/v/9086525/>

Bianca Lobo Silva
Meteorologista CREA
5063840461

