

## **ENEL DISTRIBUIÇÃO GOLÁS**



**Relatório de Evento em Situação de Emergência**

**Nº CHI-060**

1.	INTRODUÇÃO.....	3
2.	DEFINIÇÃO .....	3
3.	RESUMO EXECUTIVO.....	5
3.1.	RELATÓRIO DE OCORRÊNCIAS DO PERÍODO .....	5
4.	LISTA DE OCORRÊNCIAS .....	9
5.	PLOTAGEM DAS OCORRÊNCIAS CONFORME A ESPACIALIZAÇÃO DAS CHUVAS .....	108
6.	CLIENTES AFETADOS E IMPACTOS GLOBAIS .....	109
7.	DIAGRAMAS UNIFILARES .....	110
8.	DEMAIS EVIDÊNCIAS .....	116
8.1.	DADOS TÉCNICO - OPERACIONAIS ENEL GO.....	116
8.2.	DADOS CLIMATOLÓGICOS PELO INMET .....	118
9.	NOTÍCIAS RELACIONADAS .....	122
10.	LAUDO TÉCNICO .....	126

## 1. Introdução

As concessionárias do serviço público de distribuição de energia elétrica devem prover o serviço de forma adequada, buscando sempre a eficiência, conforme disposto na legislação e nos respectivos contratos de concessão.

Dentre a legislação vigente, destacam-se os Procedimentos de Distribuição de Energia Elétrica no Sistema Elétrico Nacional – PRODIST, que consistem em documentos elaborados pela Agência Nacional de Energia Elétrica – ANEEL, com a participação dos agentes de distribuição e de outras entidades e associações do setor elétrico nacional, que normatizam e padronizam as atividades técnicas relacionadas ao funcionamento e desempenho dos sistemas de distribuição de energia elétrica.

O Módulo 8 do PRODIST – Revisão 11, mais especificamente em sua Seção 8.2, regulamenta a qualidade do serviço prestado pelas distribuidoras de energia elétrica, estabelecendo a metodologia para apuração dos indicadores de continuidade e dos tempos de atendimento a ocorrências emergenciais.

O referido regulamento prevê que, na apuração dos indicadores coletivos e individuais deverão ser consideradas todas as interrupções de longa duração que atingirem as unidades consumidoras, admitidas algumas exceções (denominadas expurgos), que podem ser encontradas no Item 5.6.2.2 da seção 8.2 do Módulo 8 do PRODIST, transcrito abaixo:

*5.6.2.2 Na apuração dos indicadores DEC e FEC devem ser consideradas todas as interrupções, admitidas apenas as seguintes exceções:*

*i. falha nas instalações da unidade consumidora que não provoque interrupção em instalações de terceiros;*

*ii. interrupção decorrente de obras de interesse exclusivo do consumidor e que afete somente a unidade consumidora do mesmo;*

***iii. Interrupção em Situação de Emergência;***

*iv. suspensão por inadimplemento do consumidor ou por deficiência técnica e/ou de segurança das instalações da unidade consumidora que não provoque interrupção em instalações de terceiros, previstas em regulamentação;*

*v. vinculadas a programas de racionamento instituídos pela União;*

*vi. ocorridas em Dia Crítico;*

*vii. oriundas de atuação de Esquema Regional de Alívio de Carga estabelecido pelo ONS. [grifos nossos]*

Para os casos de expurgo por Interrupção em Situação de Emergência (ISE), a alínea “h” do Item 5.12.1 da seção 8.2 do Módulo 8 do PRODIST estabelece a obrigatoriedade das distribuidoras em disponibilizar, em seu sítio eletrônico, relatórios digitais com as evidências do evento que tenha gerado tais interrupções enquadradas no inciso iii do Item 5.6.2.2 do mesmo.

Nesta seara, o presente documento, visa apresentar as evidências de um evento ocorrido na área de concessão da Eletropaulo, bem como informações relevantes a respeito das interrupções em Situação de Emergência decorrentes do mesmo.

Destaca-se que, para o entendimento completo das regras de apuração dos indicadores de continuidade e expurgos, faz-se necessário também a observação das regras contidas nos Módulos 1 e 6 do PRODIST. Todos os módulos destes procedimentos encontram-se disponíveis para consulta no site da ANEEL ([www.aneel.gov.br](http://www.aneel.gov.br)) e as principais definições relacionadas ao tema estão contidas no item 2 deste documento.

## 2. Definição

Seção 1.2 do Módulo 1 do PRODIST – Revisão 10

### **2.198 Evento**

Acontecimento que afete as condições normais de funcionamento de uma rede elétrica, podendo gerar uma ou mais interrupções no fornecimento de energia.

### **2.131 e 2.158 DIC**

Duração de interrupção individual por unidade consumidora, ou seja, intervalo de tempo que, no período de apuração, em cada unidade consumidora ou ponto de conexão ocorreu descontinuidade da distribuição de energia elétrica.

### **2.216 e 2.220 FIC**

Frequência de interrupção individual por unidade consumidora, ou seja, Número de interrupções ocorridas, no período de apuração, em cada unidade consumidora ou ponto de conexão.

### **2.87 Consumidor Hora Interrompido (CHI):**

Somatório dos DICs dos consumidores atingidos por interrupção no fornecimento de energia, expresso em horas e centésimos de horas.

### **2.251 Interrupção em Situação de Emergência:**

Interrupção originada no sistema de distribuição, resultante de Evento que comprovadamente impossibilite a atuação imediata da distribuidora e que não tenha sido provocada ou agravada por esta e que seja:

- Decorrentes de evento associado a Decreto de Declaração de Situação de Emergência ou Estado de Calamidade Pública emitido por órgão competente; ou
- Decorrentes de Evento cuja soma do CHI das interrupções ocorridas no sistema de distribuição seja superior ao calculado conforme equação a seguir:

$$2.612 \times N^{0,35}$$

N – número de unidades consumidoras faturadas e atendidas em BT ou MT, com 2 (duas) casas decimais, do mês de outubro do ano anterior ao período de apuração

### 3. Resumo Executivo

O Presente Relatório tem como objetivo a incorporação de informações que sejam relevantes para que se possa fazer a devida associação aos dados contidos no documento objeto da classificação de Situação de Emergência caracterizada pelo Módulo 8 do Prodist. Este enquadramento se apresenta na maioria das vezes em condições climáticas adversas com severidade dos fatores inerentes a situação, caracterizado na maioria dos casos por fortes ventos e chuvas de grande intensidade e continuidade.

Durante a manhã do dia 22/12/2020 – terça-feira – Nuvens de tempestade associadas a formação e manutenção de uma Zona de Convergência do Atlântico Sul (ZCAS), atuaram sobre o estado de Goiás, na área de concessão da ENEL GO.

O sistema de detecção da EarthNetworks registrou 93.109 descargas atmosféricas (27.087 nuvem-solo e 67.022 nuvem-nuvem) sobre a área de concessão da ENEL em Goiás entre as 07h45 do dia 22 de dezembro de 2020 e 02h00 do dia 26 de dezembro de 2020, causando grande instabilidade na rede.

Chuva forte foi registrada pelo INMET em estações representativas da área de concessão da ENEL Distribuição Goiás. Na estação de Goiânia foram acumulados 79,0 mm de chuva entre a manhã do dia 24 e a manhã do dia 25 de dezembro de 2020, aproximadamente 27% da média climatológica para o mês na região.

#### 3.1. Relatório de Ocorrências do período

Em todo o Estado de Goiás verificou-se também que a intensidade da chuva e dos ventos danificaram a rede de distribuição de energia elétrica em diversos pontos, registrando aproximadamente 499 mil clientes com interrupção no fornecimento de energia elétrica devido a eventos relacionados ao temporal, afetando 244 municípios e 319 Subestações.

Para otimizar o volume de atendimentos e reduzir os tempos de interrupção foram mobilizados os recursos extras da empresa que aumentou o contingente em relação a situação normal de operação. O acompanhamento da quantidade de equipes e o Tempo Médio de Atendimento podem ser consultados na Pág.08 do Relatório em anexo.

O impacto e severidade do evento estão relatados em artigos de mídia, como fotos e reportagens que demonstram os danos na Rede de Distribuição, oriundos dos eventos climáticos no período. Eventos estes que afetaram 499.447 consumidores com CHI de 1.159.715,22 superior ao de 482.597,74 estabelecido como limite para definição de Situação de Emergência, conforme resumo das informações obrigatórias.

<b>Empresa</b>		ENEL DISTRIBUIÇÃO GOIÁS			
<b>Código do Relatório</b>		CHI-060 - ENEL DISTRIBUIÇÃO GOIÁS			
<b>Evento:</b>		TEMPORAL NA AREA DE CONCESSÃO DA ENEL DISTRIBUIÇÃO GOIAS			
<b>Código COBRADE:</b>	1.3.1.2.0	<b>Data Início</b>	22/12/2020	<b>Hora início</b>	07h30
<b>Código do Evento:</b>	CHI-060-ENEL GO	<b>Data Término</b>	26/12/2020	<b>Hora Término</b>	08h59
<b>Valor CHI (Limite e Real)</b>	482.597,74	1.159.715,22			
<b>Código do Decreto (Se Houver):</b>					
<b>Quantidade de Interrupções (Evento)</b>	5.020				
<b>Início 1ª Incidência (Data e Hora)</b>	22/12/2020 07:40		<b>Subestações Atingidas</b>	<p>ABADIANIA / ABC / ACREUNA / ADELANDIA / AEROPORTO / AGUA LIMPA (MARZAGAO) / AGUAS LINDAS / ALEXANIA / ALMERINDONOPOLIS / ALOANDIA / ALTO BURITI / ALTO HORIZONTE / ALTO PARAISO DE GOIAS / ALVORADA DO NORTE / AMERICANO ( RIO VERDE ) / AMERICANO DO BRASIL / AMORINOPOLIS / ANAPOLIS UNIVERSITARIA / ANHANGUERA / ANICUNS / ANTONIO DO VITTO / APARECIDA DO RIO DOCE / APORE / ARACU / ARAGARCAS / ARAGOIANIA / ARAGUAPAZ / ARARAS / AREIAS / ARENOLANDIA / ARUANA / ASA BRANCA / ATLANTICO / AURILANDIA / AVELINOPOLIS / BACURI (RIO VERDE) / BARBOSELANDIA / BARCELONA / BARREIRO (PORANGATU) / BARRO ALTO / BELA VISTA (TRANSMISSAO) / BOA VISTA / BOM JARDIM / BOM JESUS DE GOIAS / BONFINOPOLIS / BONITO / BONOPOLIS / BONSUCESSO (RIO VERDE) / BRAZABRANTES / BRITANIA / BURITI ALEGRE / BURITI DE GOIAS / BURITIZINHO / CABECEIRAS / CABRIUVA (RIO VERDE) / CACHOEIRA ALTA / CACHOEIRA DOURADA / CACHOEIRA NOVA / CACHOEIRINHA (ITARUMA) / CACU / CAIAPONIA / CALCILANDIA / CALDAS NOVAS / CALDAZINHA / CAMPESTRE / CAMPINAS / CAMPINORTE / CAMPO ALEGRE DE GOIAS / CAMPO LIMPO DE GOIAS / CAMPO NOVO / CAMPOS BELOS / CAMPOS VERDES / CARAIBAS / CARAJAS / CASTELANDIA / CATALAO / CATURAI / CEBRASA FABRICA DA AMBEV / CEMAT/BALIZA / CEPALGO / CEZARINA / CHAPADAO DO CEU / CIDADE ECLETICA / CIDADE OCIDENTAL / COCALZINHO / COLINACU / CORREGO ALEGRE / CORREGO DO OURO / CORUMBA / CORUMBAIBA / CRISTALINA / CRISTALINA TRANSMISSAO / CRISTIANOPOLIS / CRIXAS / CROMINIA / CUMARI / DAIA - ANAPOLIS / DAMOLANDIA / DAVINOPOLIS / DESFECHO / DESTILARIA BRASIL CENTRAL / DIMIC / DIORAMA / DORCELINO PEIXOTO DE MORAES / DOVERLANDIA / EDEALINA / EDEIA / ENERSUL / ESTANIFERA / ESTRELA DO NORTE / FAINA / FAZENDA CANADA / FERROVIARIO / FIRMINOPOLIS / FLORES DE GOIAS / FORMIGA / FORMOSO / FRONTEIRA / GAMELEIRA / GIRASSOL / GOIANAPOLIS / GOIANDIRA / GOIANESIA / GOIANIA LESTE / GOIANIRA / GOIAS / GOIATUBA / GOUVERLANDIA / GOYA / GUAPO / HEITORAI / HIDROLANDIA / IACIARA / INACIOLANDIA / INDEPENDENCIA / INDIARA / INHUMAS / IPAMERI / IPEGUARI / IPORA / ISRAELANDIA / ITABERAI / ITAGUARI / ITAGUARU / ITAJA / ITAPACI / ITAPACI (TRANSMISSAO) / ITAPIRAPUA / ITAPURANGA / ITAPURANGA (TRANSMISSAO) / ITARUMA / ITAUCU / ITIQUIRA (FORMOSA) / ITUMBIARA NOVA / ITUMBIARA VELHA / JACILANDIA / JANDAIA / JARAGUA / JARANAPOLIS / JATAI / JAUPACI / JESUPOLIS / JOVIANIA / JUNDIAI / JURUMIRIM / JUSCELANDIA / JUSSARA / LAGES / LAGOA DA SERRA / LAGOA DO BAUZINHO (RIO VERDE) / LEOPOLDO DE BULHOES / LUZIANIA / LUZIANIA INDUSTRIAL / MAIRIPOTABA / MAMBAI / MARA ROSA / MARAJOARA / MARIAPOLIS (PADRE BERNARDO) / MARZAGAO / MATO GRANDE / MATRINCHA / MAURILANDIA / MEIA PONTE / MINACU / MINEIROS / MINEIROS TRANSMISSAO / MOIPORA / MONTE ALEGRE / MONTES CLAROS DE GOIAS / MONTIVIDIU T / MORRINHOS / MORRO AGUDO / MOSSAMEDES / MOZARLANDIA / MOZARLANDIA (TRANSMISSAO) / MUNDO NOVO DE GOIAS / MUTUNOPOLIS / NAVESLANDIA ( JATAI ) / NAZARIO / NEROPOLIS / NIQUELANDIA / NIQUELANDIA 69KV / NOVA AMERICA / NOVA AURORA / NOVA CRIXAS (TRANSMISSAO) / NOVA IGUACU / NOVA PONTE / NOVA VENEZA / NOVO BRASIL / NOVO GAMA / NOVO PLANALTO / OLHOS DAGUA / OLOANA / ORIZONA / OURO VERDE DE GOIAS / OUVIDOR / PACAEMBU (NOVO GAMA) / PADRE BERNARDO / PALESTINA / PALMEIRAS / PALMEIRAS DE GOIAS / PALMELO / PALMINOPOLIS / PAMPLONA / PANAMA / PARANA / PARANAIBA / PARANAIGUARA / PARAUNA SE ALTA TENSAO / PARQUE DAS EMAS (MINEIROS) / PARQUE DAS NACOES / PEROLANDIA / PETROLINA / PILAR / PILOANDIA / PIRACANJUBA / PIRANHAS T / PIRENOLANDIA / PIRES DO RIO / PLANALTINA / PLANALTINA (TRANSMISSAO) / PLANALTO / PONTALINA / PORANGATU / PORTEIRAO / PORTELANDIA / POSSE / POSSELANDIA / PROFESSOR JAMIL / QUEBRA LINHA / QUIRINOPOLIS / REAL / RETIRO / GOIAS / RIO CLARO JATAI MONTIVIDIU / RIO DO PEIXE / RIO DOS BOIS (MAURILANDIA) / RIO PRETO / RIO QUENTE / RIO VERDE / RIO VERMELHO / ROCHEDO (UEH) / RUBIATABA / SANCLERLANDIA / SANTA BARBARA / SANTA FE DE GOIAS / SANTA HELENA / SANTA RITA DO ARAGUAIA / SANTA ROSA / SANTA ROSA DE GOIAS / SANTA ROSA DO MEIA PONTE / SANTA TEREZA DE GOIAS / SANTA TEREZINHA / SANTANA / SANTO ANTONIO DA BARRA / SANTO ANTONIO DE GOIAS / SANTO ANTONIO DO DESCOBERTO / SAO BARTOLOMEU / SAO DOMINGOS / SAO FRANCISCO DE GOIAS / SAO GABRIEL DE GOIAS / SAO JOAO D ALIANCA / SAO JOAO DA PARAUNA / SAO LUIZ</p>	

			DOS MONTES BELOS / SAO MIGUEL DO ARAGUAIA / SAO MIGUEL DO PASSA QUATRO / SENADOR CANEDO TRANSMISSAO / SERRA AZUL (JATAI) / SERRA DE CALDAS / SERRA DO OURO / SERRANOPOLIS / SILVANIA / SOUZALANDIA / SUCURI / TAIOBA / TAQUARI / TEREZOPOLIS / TERRA VERMELHA / TRAJANOPOLIS (PADRE BERNARDO) / TRES BARRAS / TRES RANCHOS / TRINDADE / TUCUNARE / TURVANIA / TURVELANDIA / URUACU / URUTAI / USINA DE ACUCAR DE GOIANESIA / USINA MAMBAI / VALPARAISO / VARJAO / VENDA SECA / VIANOPOLIS / VICENTINOPOLIS / VILA CORUMBA / VILA PROPICIO / XAVANTES / XIXA / ZELANDIA
<b>Início Última Incidência (Data e Hora)</b>	26/12/2020 08:59		<p><b>Municípios Atingidos</b></p>
<b>Média de Duração das Incidências (h)</b>	7,36		
<b>Duração da Incidência mais longa (h)</b>	107,07		
<b>Total de Clientes afetados</b>	499.447		<p>ABADIA DE GOIAS / ABADIANIA / ACREUNA / ADELANDIA / AGUA FRIA DE GOIAS / AGUA LIMPA / AGUAS LINDAS DE GOIAS / ALEXANIA / ALOANDIA / ALTO HORIZONTE / ALTO PARAISO DE GOIAS / ALVORADA DO NORTE / AMARALINA / AMERICANO DO BRASIL / AMORINOPOLIS / ANAPOLIS / ANHANGUERA / ANICUNS / APARECIDA DE GOIANIA / APARECIDA DO RIO DOCE / APORE / ARACU / ARAGARCAS / ARAGOIANIA / ARAGUAPAZ / ARENOPOLIS / ARUANA / AURILANDIA / AVELINOPOLIS / BALIZA / BARRO ALTO / BELA VISTA DE GOIAS / BOM JARDIM DE GOIAS / BOM JESUS DE GOIAS / BONFINOPOLIS / BONOPOLIS / BRAZABRANTES / BRITANIA / BURITI ALEGRE / BURITI DE GOIAS / BURITINOPOLIS / CABECEIRAS / CACHOEIRA ALTA / CACHOEIRA DE GOIAS / CACHOEIRA DOURADA / CACU / CAIAPONIA / CALDAS NOVAS / CALDAZINHA / CAMPESTRE DE GOIAS / CAMPINACU / CAMPINORTE / CAMPO ALEGRE DE GOIAS / CAMPO LIMPO / CAMPOS BELOS / CAMPOS VERDES / CARMO DO RIO VERDE / CASTELANDIA / CATALAO / CATURAI / CAVALCANTE / CERES / CEZARINA / CHAPADAO DO CEU / CIDADE OCIDENTAL / COCALZINHO DE GOIAS / COLINAS DO SUL / CORREGO DO OURO / CORUMBA DE GOIAS / CORUMBAIBA / CRISTALINA / CRISTIANOPOLIS / CRIXAS / CROMINIA / CUMARI / DAMIANOPOLIS / DAMOLANDIA / DAVINOPOLIS / DIORAMA / DISTRITO FEDERAL / DIVINOPOLIS DE GOIAS / DOVERLANDIA / EDEALINA / EDEIA / ESTRELA DO NORTE / FAINA / FAZENDA NOVA / FIRMINOPOLIS / FLORES DE GOIAS / FORMOSA / FORMOSO / GAMELEIRA DE GOIAS / GOIANAPOLIS / GOIANDIRA / GOIANESIA / GOIANIA / GOIANIRA / GOIAS / GOIATUBA / GOUVELANDIA / GUAPO / GUARAITA / GUARANI DE GOIAS / GUARINOS / HEITORAI / HIDROLANDIA / HIDROLINA / IACIARA / INACIOLANDIA / INDIARA / INHUMAS / IPAMERI / IPIRANGA DE GOIAS / IPORA / ISRAELANDIA / ITABERAI / ITAGUARI / ITAGUARU / ITAJA / ITAPACI / ITAPIRAPUA / ITAPURANGA / ITARUMA / ITAUCU / ITUMBIARA / IVOLANDIA / JANDAIA / JARAGUA / JATAI / JAUPACI / JESUPOLIS / JOVIANIA / JUSSARA / LAGOA SANTA / LEOPOLDO DE BULHOES / LUZIANIA / MAIRIPOTABA / MAMBAI / MARA ROSA / MARZAGAO / MATRINCHA / MAURILANDIA / MIMOSO DE GOIAS / MINACU / MINEIROS / MOIPORA / MONTE ALEGRE DE GOIAS / MONTES CLAROS DE GOIAS / MONTIVIDIU / MONTIVIDIU DO NORTE / MORRINHOS / MORRO AGUDO DE GOIAS / MOSSAMEDES / MOZARLANDIA / MUNDO NOVO DE GOIAS / MUTUNOPOLIS / NAZARIO / NEROPOLIS / NIQUELANDIA / NOVA AMERICA / NOVA AURORA / NOVA CRIXAS / NOVA GLORIA / NOVA IGUACU DE GOIAS / NOVA ROMA / NOVA VENEZA / NOVO BRASIL / NOVO GAMA / NOVO PLANALTO / ORIZONA / OURO VERDE DE GOIAS / OUVIDOR / PADRE BERNARDO / PALESTINA DE GOIAS / PALMEIRAS DE GOIAS / PALMELO / PALMINOPOLIS / PANAMA / PARANAIGUARA / PARAUNA / PEROLANDIA / PETROLINA DE GOIAS / PILAR DE GOIAS / PIRACANJUBA / PIRANHAS / PIRENOPOLIS / PIRES DO RIO / PLANALTINA / PONTALINA / PORANGATU / PORTEIRAO / PORTELANDIA / POSSE / PROFESSOR JAMIL SAFADY / QUIRINOPOLIS / RIO QUENTE / RIO VERDE / RUBIATABA / SANCLERLANDIA / SANTA BARBARA DE GOIAS / SANTA CRUZ DE GOIAS / SANTA FE DE GOIAS / SANTA HELENA DE GOIAS / SANTA ISABEL / SANTA RITA DO ARAGUAIA / SANTA RITA DO NOVO DESTINO / SANTA ROSA DE GOIAS / SANTA TEREZA DE GOIAS / SANTA TEREZINHA DE GOIAS / SANTO ANTONIO DA BARRA / SANTO ANTONIO DE GOIAS / SANTO ANTONIO DO DESCOBERTO / SAO DOMINGOS / SAO FRANCISCO DE GOIAS / SAO JOAO D ALIANCA / SAO JOAO DA PARAUNA / SAO LUIS DE MONTES BELOS / SAO LUIZ DO NORTE / SAO MIGUEL DO ARAGUAIA / SAO MIGUEL DO PASSA QUATRO / SAO PATRICIO / SAO SIMAO / SENADOR CANEDO / SERRANOPOLIS / SILVANIA / SIMOLANDIA / SITIO D ABADIA / TAQUARAL DE GOIAS / TEREZOPOLIS DE GOIAS / TRES RANCHOS / TRINDADE / TROMBAS / TURVANIA / TURVELANDIA / UIRAPURU / URUACU / URUANA / URUTAI / VALPARAISO DE GOIAS / VARJAO / VIANOPOLIS / VICENTINOPOLIS / VILA BOA / VILA PROPICIO</p>

DANOS CAUSADOS			
Equipamentos Danificado	Importância para o Sistema	Local	Quantidade
Disjuntor/Religador Operado	Proteção do Alimentador	Área de Concessão	140
Chaves Fusíveis Operada	Proteção de Ramais de Alimentadores	Área de Concessão	2.218
Transformador Operado	Proteção do Transformador	Área de Concessão	355

Relato técnico sobre a Intervenção realizada em Goiânia e Região Metropolitana						
Informações sobre Equipes	22/12	23/12	24/12	25/12	26/12	
Quantidade Usual	1.104	1.104	1.090	892	927	turmas
Quantidade Adicional	29	13	0	0	0	turmas
Quantidade Total	1.133	1.117	1.090	892	927	turmas
<u>Tempos Médios</u>						
Preparação	4,96	4,49	3,65	2,86	3,49	Horas
Deslocamento	0,92	0,79	0,78	0,86	1,00	Horas
Execução	1,02	1,02	0,84	0,87	0,97	Horas
TMAE	6,90	6,30	5,27	4,60	5,46	Horas

### Principais Dificuldades Encontradas:

Chuvas com ventos fortes provocaram muitos pontos de alagamento e enxurrada, trânsito impedido por vários semáforos desligados dificultando a chegada ao atendimento das ocorrências emergenciais. Em determinadas regiões, decorrente dos fortes ventos, houve o tombamento de árvores nas estruturas de alimentação de média tensão, danos em ramais de ligação dos clientes, impedimentos

Empresa	ENEL DISTRIBUIÇÃO GOIAS	
Valor CHI (Limite e Real)	<b>482.597,74</b>	<b>1.159.715,22</b>



#### 4. Lista de Ocorrências

DOC ORIGEM	MIUNICIPIO	EQP_ORIGEM	CONJUNTO	INI_OCORRENC	FIM_OCORRENC	DT_INI_EVENTO	DT_FIM_EVENTO	DURAÇ	UC INT	CHI	EXPURGO
202012125680	BALIZA	BH12331383	CAIAPONIA	22/12/2020 07:40	22/12/2020 18:01	22/12/2020 07:40	22/12/2020 18:01	10,34	10	103,39	CHI
202012122700	MONTIVIDIU	MV21249038	MONTIVIDIU T	22/12/2020 07:42	22/12/2020 12:10	22/12/2020 07:42	22/12/2020 12:10	4,46	1	4,46	CHI
202012122703	RIO VERDE	RV21068339	MONTIVIDIU T	22/12/2020 07:43	22/12/2020 17:00	22/12/2020 07:43	22/12/2020 17:00	9,28	1	9,28	CHI
202012123026	ITABERAI	IB12093885	ITABERAI S1	22/12/2020 07:43	22/12/2020 10:42	22/12/2020 07:43	22/12/2020 10:42	2,97	8	23,74	CHI
202012123850	SANTO ANTONIO DA BARRA	EU12000181LD	ACREUNA	22/12/2020 07:56	22/12/2020 12:32	22/12/2020 07:56	22/12/2020 12:32	4,60	1	4,60	CHI
202012123850	ACREUNA	EU12000181LD	ACREUNA	22/12/2020 07:56	22/12/2020 12:32	22/12/2020 07:56	22/12/2020 12:32	4,60	26	119,59	CHI
202012122847	SANTA RITA DO ARAGUAIA	SU12202817	SANTA RITA DO ARAGUAIA	22/12/2020 08:01	23/12/2020 10:26	22/12/2020 08:01	23/12/2020 10:26	26,41	1	26,41	CHI
202012122982	GOIAS	GS12071261	GOIAS	22/12/2020 08:01	22/12/2020 12:36	22/12/2020 08:01	22/12/2020 12:36	4,58	7	32,04	CHI
202012122952	CAIAPONIA	PH12079501	PIRANHAS	22/12/2020 08:09	23/12/2020 11:27	22/12/2020 08:09	23/12/2020 11:27	27,29	7	191,00	CHI
202012122952	PIRANHAS	PH12079501	PIRANHAS	22/12/2020 08:09	23/12/2020 11:27	22/12/2020 08:09	23/12/2020 11:27	27,29	2	54,57	CHI
202012126113	SERRANOPOLIS	SX12182120	JATAI S1	22/12/2020 08:09	23/12/2020 10:08	22/12/2020 08:09	23/12/2020 10:08	25,97	16	415,51	CHI
202012122969	SANTA HELENA DE GOIAS	SH12301343	IPEGUARI	22/12/2020 08:10	23/12/2020 00:15	22/12/2020 08:10	23/12/2020 00:15	16,08	6	96,49	CHI
202012122969	TURVELANDIA	SH12301343	IPEGUARI	22/12/2020 08:10	23/12/2020 00:15	22/12/2020 08:10	23/12/2020 00:15	16,08	3	48,24	CHI
202012124250	MOZARLANDIA	MZ12220222	MOZARLANDIA	22/12/2020 08:12	22/12/2020 12:38	22/12/2020 08:12	22/12/2020 12:38	4,42	10	44,19	CHI
202012126539	HEITORAI	HE12390849	ITAPURANGA	22/12/2020 08:14	23/12/2020 14:25	22/12/2020 08:14	23/12/2020 14:25	30,17	30	905,11	CHI
202012126539	ITAPURANGA	HE12390849	ITAPURANGA	22/12/2020 08:14	23/12/2020 14:25	22/12/2020 08:14	23/12/2020 14:25	30,17	1	30,17	CHI
202012123066	QUIRINOPOLIS	QI12400162	QUIRINOPOLIS	22/12/2020 08:19	22/12/2020 11:50	22/12/2020 08:19	22/12/2020 11:50	3,51	2	7,03	CHI
202012123071	QUIRINOPOLIS	QI12244963	CACHOEIRA ALTA	22/12/2020 08:19	22/12/2020 11:25	22/12/2020 08:19	22/12/2020 11:25	3,10	2	6,19	CHI
202012126171	DOVERLANDIA	DV12138316	CAIAPONIA	22/12/2020 08:19	23/12/2020 14:38	22/12/2020 08:19	23/12/2020 14:38	30,31	2	60,61	CHI
202012125018	DIORAMA	DI12231110	IPORA	22/12/2020 08:22	22/12/2020 15:14	22/12/2020 08:22	22/12/2020 15:14	6,85	4	27,40	CHI
202012123124	IVOLANDIA	IV12402910	IPORA	22/12/2020 08:23	22/12/2020 13:30	22/12/2020 08:23	22/12/2020 13:30	5,10	7	35,72	CHI
202012125345	IVOLANDIA	IV12207829	IPORA	22/12/2020 08:23	23/12/2020 12:07	22/12/2020 08:23	23/12/2020 12:07	27,73	3	83,20	CHI
202012125590	GOIAS	GS12064979	ITAPURANGA	22/12/2020 08:23	23/12/2020 19:56	22/12/2020 08:23	23/12/2020 19:56	35,56	1	35,56	CHI
202012125590	FAINA	GS12064979	ITAPURANGA	22/12/2020 08:23	23/12/2020 19:56	22/12/2020 08:23	23/12/2020 19:56	35,56	3	106,67	CHI
202012123134	PALMEIRAS DE GOIAS	PL12362889	PALMEIRAS	22/12/2020 08:24	22/12/2020 09:42	22/12/2020 08:24	22/12/2020 09:42	1,29	176	227,63	CHI
202012123639	CAIAPONIA	MV12340904	MONTIVIDIU T	22/12/2020 08:26	22/12/2020 10:32	22/12/2020 08:26	22/12/2020 10:32	2,10	1	2,10	CHI
202012123639	MONTIVIDIU	MV12340904	MONTIVIDIU T	22/12/2020 08:26	22/12/2020 10:32	22/12/2020 08:26	22/12/2020 10:32	2,10	10	20,99	CHI
202012123985	FAZENDA NOVA	FN12370945	IPORA	22/12/2020 08:27	22/12/2020 15:26	22/12/2020 08:27	22/12/2020 15:26	6,98	4	27,92	CHI
202012123186	RIO VERDE	630130530	RIO VERDE S2	22/12/2020 08:29	22/12/2020 11:48	22/12/2020 08:29	22/12/2020 11:48	3,32	1	3,32	CHI
202012123215	MINEIROS	DI12219562	CHAPADAO DO CEU	22/12/2020 08:30	23/12/2020 14:17	22/12/2020 08:30	23/12/2020 09:00	24,49	1	24,49	CHI
202012123215	MINEIROS	DI12219562	CHAPADAO DO CEU	22/12/2020 08:30	23/12/2020 14:17	23/12/2020 07:25	23/12/2020 09:00	1,59	1	1,59	CHI
202012123215	CHAPADAO DO CEU	DI12219562	CHAPADAO DO CEU	22/12/2020 08:30	23/12/2020 14:17	22/12/2020 08:30	23/12/2020 09:19	24,82	1	24,82	CHI
202012123215	CHAPADAO DO CEU	DI12219562	CHAPADAO DO CEU	22/12/2020 08:30	23/12/2020 14:17	22/12/2020 08:30	23/12/2020 14:17	29,78	7	208,46	CHI
202012123215	MINEIROS	DI12219562	CHAPADAO DO CEU	22/12/2020 08:30	23/12/2020 14:17	22/12/2020 08:30	23/12/2020 14:17	29,78	2	59,56	CHI
202012123215	CHAPADAO DO CEU	DI12365007LD	CHAPADAO DO CEU	22/12/2020 08:30	23/12/2020 14:17	23/12/2020 07:25	23/12/2020 14:17	6,88	1	6,88	CHI
202012124028	MATRINCHA	MP12299780	MATRINCHA	22/12/2020 08:30	22/12/2020 13:02	22/12/2020 08:30	22/12/2020 13:02	4,53	2	9,05	CHI
202012123253	CACHOEIRA ALTA	CA21198367	CACHOEIRA ALTA	22/12/2020 08:35	22/12/2020 09:53	22/12/2020 08:35	22/12/2020 09:53	1,29	1	1,29	CHI
202012123260	ITARUMA	IM12018057	CACHOEIRA ALTA	22/12/2020 08:35	22/12/2020 13:14	22/12/2020 08:35	22/12/2020 13:14	4,64	2	9,28	CHI
202012123808	PARAUNA	PU12194225	FIRMINOPOLIS S2	22/12/2020 08:38	22/12/2020 18:01	22/12/2020 08:38	22/12/2020 17:02	8,41	3	25,23	CHI
202012123808	PARAUNA	PU12194225	FIRMINOPOLIS S2	22/12/2020 08:38	22/12/2020 18:01	22/12/2020 08:38	22/12/2020 17:32	8,91	3	26,72	CHI
202012123808	PARAUNA	PU12194225	FIRMINOPOLIS S2	22/12/2020 08:38	22/12/2020 18:01	22/12/2020 08:38	22/12/2020 18:01	9,40	6	56,38	CHI
202012125521	ITAJA	IJ12087676	ITAJA S2	22/12/2020 08:39	22/12/2020 16:10	22/12/2020 08:39	22/12/2020 16:10	7,51	2	15,03	CHI
202012123346	NOVA CRIXAS	NA12103783	MOZARLANDIA	22/12/2020 08:40	22/12/2020 21:34	22/12/2020 08:40	22/12/2020 21:34	12,90	1	12,90	CHI
202012123691	SANTA HELENA DE GOIAS	SH12214105	ACREUNA	22/12/2020 08:40	22/12/2020 12:30	22/12/2020 08:40	22/12/2020 12:30	3,82	8	30,58	CHI
202012123944	SAO LUIS DE MONTES BELOS	SL12391445	FIRMINOPOLIS S1	22/12/2020 08:41	22/12/2020 12:00	22/12/2020 08:41	22/12/2020 12:00	3,31	6	19,87	CHI
202012124213	FAZENDA NOVA	FN12060693	IPORA	22/12/2020 08:41	22/12/2020 16:57	22/12/2020 08:41	22/12/2020 16:57	8,27	11	90,93	CHI
202012123369	ITABERAI	IB12310616	ITABERAI S2	22/12/2020 08:42	22/12/2020 17:41	22/12/2020 08:42	22/12/2020 17:41	8,97	6	53,84	CHI

202012124485	RIO VERDE	RV12153955	RIO VERDE S2	22/12/2020 08:42	22/12/2020 12:19	22/12/2020 08:42	22/12/2020 12:19	3,61	531	1916,17	CHI
202012123381	ACREUNA	EU12301451	ACREUNA	22/12/2020 08:43	22/12/2020 18:35	22/12/2020 08:43	22/12/2020 18:35	9,85	1	9,85	CHI
202012123457	PALMEIRAS DE GOIAS	PL12000091	ANICUNS	22/12/2020 08:46	22/12/2020 10:00	22/12/2020 08:46	22/12/2020 10:00	1,22	7	8,55	CHI
202012124673	GOIAS	GS12140275	MATRINCHA	22/12/2020 08:47	22/12/2020 13:58	22/12/2020 08:47	22/12/2020 13:58	5,17	13	67,24	CHI
202012123713	SANTO ANTONIO DA BARRA	BZ12428466	ACREUNA	22/12/2020 08:52	22/12/2020 14:38	22/12/2020 08:52	22/12/2020 14:38	5,76	13	74,87	CHI
202012123714	SANTO ANTONIO DA BARRA	BZ21331678	ACREUNA	22/12/2020 08:58	22/12/2020 12:51	22/12/2020 08:58	22/12/2020 12:51	3,89	1	3,89	CHI
202012124065	PORTELANDIA	PW10406624	PARQUE DAS EMAS	22/12/2020 08:59	22/12/2020 14:19	22/12/2020 08:59	22/12/2020 14:19	5,33	3	16,00	CHI
202012124065	MINEIROS	PW10406624	PARQUE DAS EMAS	22/12/2020 08:59	22/12/2020 14:19	22/12/2020 08:59	22/12/2020 14:19	5,33	62	330,67	CHI
202012124198	RIO VERDE	RV12247304	CACHOEIRA ALTA	22/12/2020 09:02	22/12/2020 18:51	22/12/2020 09:02	22/12/2020 18:51	9,80	4	39,22	CHI
202012124435	RIO VERDE	RV11000005	RIO VERDE S1	22/12/2020 09:02	22/12/2020 19:20	22/12/2020 16:38	22/12/2020 19:20	2,70	169	456,35	CHI
202012123611	NOVA AMERICA	10003133360	RUBIATABA	22/12/2020 09:06	22/12/2020 15:05	22/12/2020 09:06	22/12/2020 15:05	5,98	1	5,98	CHI
202012123661	MONTIVIDIU	MV12267614B	MONTIVIDIU T	22/12/2020 09:11	22/12/2020 15:40	22/12/2020 09:11	22/12/2020 15:40	6,47	16	103,56	CHI
202012123677	BOM JARDIM DE GOIAS	BM12354692	BOM JARDIM	22/12/2020 09:12	22/12/2020 11:35	22/12/2020 09:12	22/12/2020 11:35	2,38	4	9,53	CHI
202012123960	MOSSAMEDES	ND12299618	ITABERAI S2	22/12/2020 09:12	22/12/2020 10:54	22/12/2020 09:12	22/12/2020 10:54	1,69	18	30,34	CHI
202012123741	CACU	CC12164172LD	CACHOEIRA ALTA	22/12/2020 09:19	22/12/2020 14:24	22/12/2020 09:19	22/12/2020 14:24	5,07	85	431,37	CHI
202012124581	PARAUNA	PU12391520	FIRMINOPOLIS S2	22/12/2020 09:19	22/12/2020 18:21	22/12/2020 09:19	22/12/2020 18:21	9,02	2	18,05	CHI
202012123935	SAO LUIS DE MONTES BELOS	SL12388893	SAO LUIZ DOS MONTES BELOS	22/12/2020 09:20	22/12/2020 12:40	22/12/2020 09:20	22/12/2020 12:40	3,33	2	6,67	CHI
202012123935	SANCLERLANDIA	SL12388893	SAO LUIZ DOS MONTES BELOS	22/12/2020 09:20	22/12/2020 12:40	22/12/2020 09:20	22/12/2020 12:40	3,33	7	23,33	CHI
202012123763	SERRANOPOLIS	SX12214496	JATAI S1	22/12/2020 09:22	22/12/2020 12:15	22/12/2020 09:22	22/12/2020 12:15	2,88	2	5,76	CHI
202012123981	ARUANA	AK12310746	MOZARLANDIA	22/12/2020 09:23	22/12/2020 15:53	22/12/2020 09:23	22/12/2020 15:53	6,49	4	25,97	CHI
202012123792	ITAPURANGA	IK12426653	ITAPURANGA	22/12/2020 09:25	22/12/2020 14:14	22/12/2020 09:25	22/12/2020 14:14	4,81	15	72,18	CHI
202012123793	APORE	AE12365099	ITAJA S1	22/12/2020 09:25	22/12/2020 23:59	22/12/2020 09:25	22/12/2020 23:59	14,56	2	29,13	CHI
202012123809	URUACU	UR12242674	URUACU	22/12/2020 09:26	22/12/2020 11:33	22/12/2020 09:26	22/12/2020 11:33	2,10	2	4,20	CHI
202012123820	RIO VERDE	RV12159300	CABRIUVA S2	22/12/2020 09:28	22/12/2020 12:53	22/12/2020 09:28	22/12/2020 12:53	3,40	11	37,42	CHI
202012123825	ESTRELA DO NORTE	ET12000003	MARA ROSA	22/12/2020 09:29	22/12/2020 10:55	22/12/2020 09:29	22/12/2020 10:55	1,43	1	1,43	CHI
202012123825	MARA ROSA	ET12000003	MARA ROSA	22/12/2020 09:29	22/12/2020 10:55	22/12/2020 09:29	22/12/2020 10:55	1,43	2	2,85	CHI
202012123834	JATAI	JT11036799	JATAI S2	22/12/2020 09:30	22/12/2020 12:17	22/12/2020 09:30	22/12/2020 12:17	2,77	21	58,27	CHI
202012123863	CRIXAS	CX12318471	SERRA DO OURO	22/12/2020 09:34	22/12/2020 20:49	22/12/2020 09:34	22/12/2020 20:49	11,25	12	135,03	CHI
202012123902	MINACU	IH12181684	MINACU	22/12/2020 09:38	22/12/2020 17:57	22/12/2020 09:38	22/12/2020 17:57	8,30	61	506,60	CHI
202012123902	CAMPINACU	IH12181684	MINACU	22/12/2020 09:38	22/12/2020 17:57	22/12/2020 09:38	22/12/2020 17:57	8,30	17	141,18	CHI
202012123937	RIO VERDE	630561783	RIO VERDE S1	22/12/2020 09:43	23/12/2020 08:24	22/12/2020 09:43	23/12/2020 08:24	22,70	1	22,70	CHI
202012123953	TURVELANDIA	TD18428252TS	RIO DOS BOIS	22/12/2020 09:44	22/12/2020 11:55	22/12/2020 09:44	22/12/2020 11:55	2,18	19	41,35	CHI
202012123955	RIO VERDE	RV12322315LD	CABRIUVA S2	22/12/2020 09:44	22/12/2020 20:19	22/12/2020 09:44	22/12/2020 20:19	10,57	1	10,57	CHI
202012124196	APORE	AE12000052	ITAJA S1	22/12/2020 09:46	22/12/2020 13:56	22/12/2020 09:46	22/12/2020 13:56	4,16	12	49,92	CHI
202012123979	ARENOPOLIS	AY12331924	ARENOPOLIS	22/12/2020 09:47	22/12/2020 16:30	22/12/2020 09:47	22/12/2020 16:30	6,71	1	6,71	CHI
202012128153	MINEIROS	01140434	PARQUE DAS EMAS	22/12/2020 09:47	22/12/2020 22:03	22/12/2020 18:53	22/12/2020 22:03	3,17	120	380,00	CHI
202012123986	MINACU	4020091135	MINACU	22/12/2020 09:48	22/12/2020 15:05	22/12/2020 09:48	22/12/2020 15:05	5,29	1	5,29	CHI
202012127377	MINEIROS	MY12274044	PARQUE DAS EMAS	22/12/2020 09:48	23/12/2020 16:28	22/12/2020 09:48	23/12/2020 16:28	30,67	2	61,33	CHI
202012124005	ITABERAI	IB12386586	ITABERAI S1	22/12/2020 09:50	22/12/2020 09:57	22/12/2020 09:50	22/12/2020 09:57	0,11	2	0,22	CHI
202012124010	APORE	AE12162691	ITAJA S1	22/12/2020 09:51	22/12/2020 18:58	22/12/2020 09:51	22/12/2020 18:58	9,12	1	9,12	CHI
202012124019	JATAI	JT12182107	JATAI S1	22/12/2020 09:52	23/12/2020 08:09	22/12/2020 09:52	23/12/2020 08:09	22,28	2	44,56	CHI
202012124024	NOVO BRASIL	NB21020264	JUSSARA	22/12/2020 09:53	22/12/2020 13:20	22/12/2020 09:53	22/12/2020 13:20	3,44	1	3,44	CHI
202012124047	MINEIROS	10025806775	PARQUE DAS EMAS	22/12/2020 09:55	23/12/2020 07:30	22/12/2020 09:55	23/12/2020 07:30	21,57	1	21,57	CHI
202012121516	ITARUMA	SX12153265	JATAI S1	22/12/2020 09:57	22/12/2020 12:14	22/12/2020 09:57	22/12/2020 12:14	2,27	1	2,27	CHI
202012121516	SERRANOPOLIS	SX12153265	JATAI S1	22/12/2020 09:57	22/12/2020 12:14	22/12/2020 09:57	22/12/2020 12:14	2,27	4	9,09	CHI
202012121516	APORE	SX12153265	JATAI S1	22/12/2020 09:57	22/12/2020 12:14	22/12/2020 09:57	22/12/2020 12:14	2,27	7	15,90	CHI
202012124055	JATAI	JT12234311RE	JATAI S2	22/12/2020 09:57	22/12/2020 17:02	22/12/2020 09:57	22/12/2020 17:02	7,08	35	247,82	CHI
202012124707	GOIAS	GS12073686	MATRINCHA	22/12/2020 09:57	22/12/2020 16:57	22/12/2020 09:57	22/12/2020 16:57	6,99	5	34,94	CHI
202012124096	GOIAS	IB21091706	ITABERAI S1	22/12/2020 10:04	22/12/2020 11:31	22/12/2020 10:04	22/12/2020 11:31	1,43	1	1,43	CHI
202012124099	IPORA	IR21358976	IPORA	22/12/2020 10:05	22/12/2020 15:28	22/12/2020 10:05	22/12/2020 15:28	5,38	1	5,38	CHI
202012124702	MINEIROS	MY12266483	PARQUE DAS EMAS	22/12/2020 10:06	23/12/2020 09:55	22/12/2020 10:06	23/12/2020 09:55	23,80	7	166,63	CHI

202012124134	CACHOEIRA ALTA	CA12380670	CACHOEIRA ALTA	22/12/2020 10:08	22/12/2020 12:44	22/12/2020 10:08	22/12/2020 12:44	2,59	5	12,94	CHI
202012124124	MINACU	IH13192307	MINACU	22/12/2020 10:17	24/12/2020 13:30	22/12/2020 10:17	23/12/2020 20:53	34,61	7	242,24	CHI
202012124124	MINACU	IH12192297	MINACU	22/12/2020 10:17	24/12/2020 13:30	22/12/2020 10:17	23/12/2020 21:47	35,50	7	248,48	CHI
202012124124	MINACU	IH12348002	MINACU	22/12/2020 10:17	24/12/2020 13:30	22/12/2020 10:17	23/12/2020 22:03	35,77	26	929,93	CHI
202012124124	MINACU	IH12348012	MINACU	22/12/2020 10:17	24/12/2020 13:30	22/12/2020 10:17	23/12/2020 22:37	36,34	16	581,47	CHI
202012124124	MINACU	IH12192271	MINACU	22/12/2020 10:17	24/12/2020 13:30	22/12/2020 10:17	23/12/2020 22:48	36,53	6	219,16	CHI
202012124124	MINACU	IH12325778	MINACU	22/12/2020 10:17	24/12/2020 13:30	22/12/2020 10:17	23/12/2020 23:51	37,57	5	187,84	CHI
202012124124	MINACU	IH12325681	MINACU	22/12/2020 10:17	24/12/2020 13:30	22/12/2020 10:17	24/12/2020 00:23	38,10	4	152,42	CHI
202012124124	MINACU	IH12320901	MINACU	22/12/2020 10:17	24/12/2020 13:30	22/12/2020 10:17	24/12/2020 00:58	38,69	1	38,69	CHI
202012124124	MINACU	IH12202490	MINACU	22/12/2020 10:17	24/12/2020 13:30	22/12/2020 10:17	24/12/2020 01:59	39,70	3	119,10	CHI
202012124124	MINACU	IH12236279LD	MINACU	22/12/2020 10:17	24/12/2020 13:30	22/12/2020 10:17	24/12/2020 13:30	51,22	4	204,88	CHI
202012124224	ACREUNA	EU12045542	ACREUNA	22/12/2020 10:20	22/12/2020 15:18	22/12/2020 10:20	22/12/2020 15:18	4,96	5	24,82	CHI
202012124364	MUTUNOPOLIS	MU12068529	MARA ROSA	22/12/2020 10:30	22/12/2020 18:17	22/12/2020 10:30	22/12/2020 13:23	2,89	32	92,48	CHI
202012124364	MUTUNOPOLIS	MU13384320	MARA ROSA	22/12/2020 10:30	22/12/2020 18:17	22/12/2020 10:30	22/12/2020 18:17	7,79	12	93,48	CHI
202012124364	PORANGATU	MU13384320	MARA ROSA	22/12/2020 10:30	22/12/2020 18:17	22/12/2020 10:30	22/12/2020 18:17	7,79	12	93,48	CHI
202012124326	MINEIROS	MY21348946	PARQUE DAS EMAS	22/12/2020 10:37	22/12/2020 14:01	22/12/2020 10:37	22/12/2020 14:01	3,40	1	3,40	CHI
202012124374	MAURILANDIA	ML12303569	RIO DOS BOIS	22/12/2020 10:43	23/12/2020 00:04	22/12/2020 10:43	23/12/2020 00:04	13,35	3	40,06	CHI
202012124380	PORANGATU	PO12246538	PORANGATU	22/12/2020 10:44	22/12/2020 19:39	22/12/2020 10:44	22/12/2020 19:39	8,91	1	8,91	CHI
202012124383	ACREUNA	EU12207224	ACREUNA	22/12/2020 10:44	22/12/2020 20:44	22/12/2020 10:44	22/12/2020 20:44	10,00	2	20,00	CHI
202012124639	SANTA HELENA DE GOIAS	TD12025737	RIO DOS BOIS	22/12/2020 10:45	22/12/2020 12:44	22/12/2020 10:45	22/12/2020 12:44	1,97	18	35,45	CHI
202012124639	ACREUNA	TD12025737	RIO DOS BOIS	22/12/2020 10:45	22/12/2020 12:44	22/12/2020 10:45	22/12/2020 12:44	1,97	26	51,21	CHI
202012124639	TURVELANDIA	TD12025737	RIO DOS BOIS	22/12/2020 10:45	22/12/2020 12:44	22/12/2020 10:45	22/12/2020 12:44	1,97	66	130,00	CHI
202012124414	MAURILANDIA	ML21303572	RIO DOS BOIS	22/12/2020 10:49	22/12/2020 15:49	22/12/2020 10:49	22/12/2020 15:49	4,99	1	4,99	CHI
202012124862	RIO VERDE	RV12301462	ACREUNA	22/12/2020 10:54	22/12/2020 20:42	22/12/2020 10:54	22/12/2020 20:42	9,80	16	156,78	CHI
202012124862	SANTO ANTONIO DA BARRA	RV12301462	ACREUNA	22/12/2020 10:54	22/12/2020 20:42	22/12/2020 10:54	22/12/2020 20:42	9,80	1	9,80	CHI
202012124488	GOIAS	8704990	MATRINCHA	22/12/2020 11:02	22/12/2020 21:31	22/12/2020 11:02	22/12/2020 21:31	10,47	2	20,94	CHI
202012124497	BOM JESUS DE GOIAS	BJ12205369	BOM JESUS DE GOIAS	22/12/2020 11:04	22/12/2020 18:41	22/12/2020 11:04	22/12/2020 18:41	7,60	2	15,20	CHI
202012124500	MUTUNOPOLIS	MU21086714	MARA ROSA	22/12/2020 11:05	23/12/2020 11:56	22/12/2020 11:05	23/12/2020 11:56	24,84	1	24,84	CHI
202012124519	GOIATUBA	GT21203261	GOIATUBA S2	22/12/2020 11:08	22/12/2020 23:12	22/12/2020 11:08	22/12/2020 23:12	12,07	1	12,07	CHI
202012123844	RUBIATABA	780079292	RUBIATABA	22/12/2020 11:11	22/12/2020 13:32	22/12/2020 11:11	22/12/2020 13:32	2,34	1	2,34	CHI
202012124654	QUIRINOPOLIS	QI12000278	QUIRINOPOLIS	22/12/2020 11:14	22/12/2020 20:42	22/12/2020 11:14	22/12/2020 20:42	9,46	11	104,10	CHI
202012124583	MONTES CLAROS DE GOIAS	ME12395480	IPORA	22/12/2020 11:19	22/12/2020 16:15	22/12/2020 11:19	22/12/2020 16:15	4,93	5	24,64	CHI
202012125165	PALESTINA DE GOIAS	PY12244702	PALESTINA	22/12/2020 11:22	23/12/2020 09:58	22/12/2020 11:22	23/12/2020 09:58	22,59	2	45,19	CHI
202012125165	CAIAPONIA	PY12244702	PALESTINA	22/12/2020 11:22	23/12/2020 09:58	22/12/2020 11:22	23/12/2020 09:58	22,59	48	1084,52	CHI
202012124618	GOIANDIRA	GD12000015	CATALAO S1	22/12/2020 11:26	22/12/2020 17:12	22/12/2020 11:26	22/12/2020 17:12	5,76	6	34,59	CHI
202012124630	SITIO D ABADIA	SI12302925	IACIARA S2	22/12/2020 11:28	22/12/2020 12:07	22/12/2020 11:28	22/12/2020 12:07	0,65	3	1,94	CHI
202012124647	MONTES CLAROS DE GOIAS	ME12091504	IPORA	22/12/2020 11:30	22/12/2020 16:24	22/12/2020 11:30	22/12/2020 16:24	4,89	1	4,89	CHI
202012126671	MARA ROSA	MQ12187776	MARA ROSA	22/12/2020 11:31	22/12/2020 22:44	22/12/2020 11:31	22/12/2020 22:44	11,20	2	22,40	CHI
202012124889	SANTA CRUZ DE GOIAS	BC12012519	PIRES DO RIO S2	22/12/2020 11:33	22/12/2020 16:15	22/12/2020 11:33	22/12/2020 16:15	4,69	2	9,38	CHI
202012124665	CASTELANDIA	DM12193866	QUIRINOPOLIS	22/12/2020 11:34	22/12/2020 14:27	22/12/2020 11:34	22/12/2020 14:27	2,88	2	5,75	CHI
202012125122	SAO JOAO DA PARAUNA	FR12040685	FIRMINOPOLIS S2	22/12/2020 11:36	22/12/2020 16:29	22/12/2020 11:36	22/12/2020 16:29	4,88	6	29,29	CHI
202012124696	SERRANOPOLIS	SX12296482	JATAI S1	22/12/2020 11:42	22/12/2020 23:26	22/12/2020 11:42	22/12/2020 23:26	11,72	2	23,44	CHI
202012124704	NIQUELANDIA	NQ12378072	NIQUELANDIA SUBTRANSMISSAO	22/12/2020 11:44	23/12/2020 09:14	22/12/2020 11:44	23/12/2020 09:14	21,50	1	21,50	CHI
202012124705	IACIARA	6910001936	IACIARA S2	22/12/2020 11:44	22/12/2020 15:28	22/12/2020 11:44	22/12/2020 15:28	3,73	1	3,73	CHI
202012125456	RIO VERDE	RV12413139	MONTIVIDUI T	22/12/2020 11:44	22/12/2020 19:30	22/12/2020 11:44	22/12/2020 19:30	7,75	1	7,75	CHI
202012125456	MONTIVIDUI	RV12413139	MONTIVIDUI T	22/12/2020 11:44	22/12/2020 19:30	22/12/2020 11:44	22/12/2020 19:30	7,75	1	7,75	CHI
202012124717	URUTAI	UT12272879	URUTAI	22/12/2020 11:47	22/12/2020 14:18	22/12/2020 11:47	22/12/2020 14:18	2,52	3	7,55	CHI
202012125000	PIRES DO RIO	PR12000076	PIRES DO RIO S1	22/12/2020 11:50	22/12/2020 15:47	22/12/2020 11:50	22/12/2020 15:47	3,94	2	7,87	CHI
202012124747	SANTA TEREZINHA DE GOIAS	SG12213046	SANTA TEREZINHA	22/12/2020 11:52	22/12/2020 17:41	22/12/2020 11:52	22/12/2020 17:41	5,82	9	52,34	CHI
202012124747	CAMPOS VERDES	SG12213046	SANTA TEREZINHA	22/12/2020 11:52	22/12/2020 17:41	22/12/2020 11:52	22/12/2020 17:41	5,82	8	46,52	CHI
202012125371	ADELANDIA	AC12299009	FIRMINOPOLIS S2	22/12/2020 11:52	22/12/2020 16:20	22/12/2020 11:52	22/12/2020 16:20	4,46	12	53,52	CHI

202012125371	ANICUNS	AC12299009	FIRMINOPOLIS S2	22/12/2020 11:52	22/12/2020 16:20	22/12/2020 11:52	22/12/2020 16:20	4,46	1	4,46	CHI
202012124763	INDIARA	IY21010815	EDEIA	22/12/2020 11:56	22/12/2020 22:25	22/12/2020 11:56	22/12/2020 22:04	10,15	1	10,15	CHI
202012124763	CEZARINA	IY12010807	EDEIA	22/12/2020 11:56	22/12/2020 22:25	22/12/2020 20:20	22/12/2020 22:25	2,09	1	2,09	CHI
202012124763	INDIARA	IY12010807	EDEIA	22/12/2020 11:56	22/12/2020 22:25	22/12/2020 20:20	22/12/2020 22:25	2,09	31	64,71	CHI
202012124765	CALDAS NOVAS	10028689753	CALDAS NOVAS S2	22/12/2020 11:56	23/12/2020 07:53	22/12/2020 11:56	23/12/2020 07:53	19,96	1	19,96	CHI
202012124767	ITARUMA	2310005430	CACHOEIRA ALTA	22/12/2020 11:56	22/12/2020 21:00	22/12/2020 11:56	22/12/2020 21:00	9,05	1	9,05	CHI
202012124781	NIQUELANDIA	NQ12328636	NIQUELANDIA SUBTRANSMISSAO	22/12/2020 11:58	22/12/2020 22:16	22/12/2020 11:58	22/12/2020 22:16	10,28	2	20,57	CHI
202012125099	MINEIROS	PW12374393	PARQUE DAS EMAS	22/12/2020 11:58	23/12/2020 11:30	22/12/2020 11:58	23/12/2020 11:30	23,52	5	117,62	CHI
202012124786	CALDAS NOVAS	760337536	SERRA DE CALDAS	22/12/2020 11:59	22/12/2020 22:13	22/12/2020 11:59	22/12/2020 22:13	10,23	1	10,23	CHI
202012124791	CUMARI	CT12266315	CATALAO S2	22/12/2020 11:59	22/12/2020 12:42	22/12/2020 11:59	22/12/2020 12:42	0,70	1	0,70	CHI
202012125149	ARAGOIANIA	AO32021484	GUAPO S2	22/12/2020 12:00	22/12/2020 17:05	22/12/2020 12:00	22/12/2020 17:05	5,07	5	25,34	CHI
202012125342	ARAGOIANIA	AO12092571	GUAPO S2	22/12/2020 12:01	22/12/2020 15:54	22/12/2020 12:01	22/12/2020 15:54	3,87	64	247,48	CHI
202012124807	CAIAPONIA	CP12072079	CAIAPONIA	22/12/2020 12:04	22/12/2020 14:12	22/12/2020 12:04	22/12/2020 14:12	2,13	8	17,06	CHI
202012125301	MUNDO NOVO DE GOIAS	MH12357676	NOVA CRIXAS	22/12/2020 12:04	24/12/2020 11:29	22/12/2020 12:04	23/12/2020 12:47	24,71	15	370,67	CHI
202012125301	MUNDO NOVO DE GOIAS	MH12357676	NOVA CRIXAS	22/12/2020 12:04	24/12/2020 11:29	22/12/2020 12:04	24/12/2020 11:29	47,41	9	426,71	CHI
202012124815	ARENOPOLIS	AY12354601	IPORA	22/12/2020 12:05	22/12/2020 16:11	22/12/2020 12:05	22/12/2020 16:11	4,08	1	4,08	CHI
202012124815	PIRANHAS	AY12354601	IPORA	22/12/2020 12:05	22/12/2020 16:11	22/12/2020 12:05	22/12/2020 16:11	4,08	1	4,08	CHI
202012124827	SAO MIGUEL DO ARAGUAIA	SM21315126	SAO MIGUEL DO ARAGUAIA	22/12/2020 12:06	23/12/2020 08:00	22/12/2020 12:06	23/12/2020 08:00	19,89	1	19,89	CHI
202012122967	BALIZA	BH11331182	CAIAPONIA	22/12/2020 12:07	22/12/2020 16:10	22/12/2020 12:07	22/12/2020 16:10	4,04	1	4,04	CHI
202012125572	CORUMBAIBA	CI12234656	VILA CORUMBA	22/12/2020 12:07	22/12/2020 21:49	22/12/2020 12:07	22/12/2020 21:49	9,69	2	19,38	CHI
202012124849	NIQUELANDIA	NQ12251186	URUACU	22/12/2020 12:10	22/12/2020 16:17	22/12/2020 12:10	22/12/2020 16:17	4,11	9	36,99	CHI
202012125197	SILVANIA	SV12058432	DAIA S2	22/12/2020 12:12	22/12/2020 14:52	22/12/2020 12:12	22/12/2020 14:52	2,66	10	26,62	CHI
202012124887	ARAGARCAS	AG21139927	ARAGARCAS	22/12/2020 12:15	22/12/2020 16:08	22/12/2020 12:15	22/12/2020 16:08	3,87	1	3,87	CHI
202012126072	APORE	AE12249715LD	ITAJA S1	22/12/2020 12:15	22/12/2020 16:22	22/12/2020 12:15	22/12/2020 16:22	4,11	7	28,76	CHI
202012124906	ARAGUAPAZ	FC12071270	GOIAS	22/12/2020 12:18	22/12/2020 17:20	22/12/2020 12:18	22/12/2020 17:20	5,03	4	20,11	CHI
202012124906	FAINA	FC12071270	GOIAS	22/12/2020 12:18	22/12/2020 17:20	22/12/2020 12:18	22/12/2020 17:20	5,03	4	20,11	CHI
202012126086	COCALZINHO DE GOIAS	ZN12302398	COCALZINHO	22/12/2020 12:18	23/12/2020 01:38	22/12/2020 12:18	23/12/2020 01:38	13,33	12	160,00	CHI
202012125027	BOM JESUS DE GOIAS	BJ12296936	BOM JESUS DE GOIAS	22/12/2020 12:20	22/12/2020 15:46	22/12/2020 12:20	22/12/2020 15:46	3,42	2	6,83	CHI
202012125189	CACU	CC12196048	CACHOEIRA ALTA	22/12/2020 12:22	22/12/2020 15:11	22/12/2020 12:22	22/12/2020 15:11	2,82	19	53,51	CHI
202012125734	PLANALTINA	PI12199859	PLANALTINA	22/12/2020 12:25	22/12/2020 22:55	22/12/2020 12:25	22/12/2020 22:55	10,50	5	52,49	CHI
202012124968	GOIANIA	GN11002484	GOIANIA LESTE S2	22/12/2020 12:26	22/12/2020 15:45	22/12/2020 14:50	22/12/2020 15:45	0,92	26	23,83	CHI
202012124969	BALIZA	BH12061407	BOM JARDIM	22/12/2020 12:26	22/12/2020 16:14	22/12/2020 12:26	22/12/2020 16:14	3,79	31	117,44	CHI
202012125849	GOIATUBA	GT12296905	GOIATUBA S2	22/12/2020 12:27	22/12/2020 20:39	22/12/2020 12:27	22/12/2020 20:39	8,19	7	57,32	CHI
202012127566	SERRANOPOLIS	SX12105189	JATAI S1	22/12/2020 12:28	22/12/2020 22:11	22/12/2020 12:28	22/12/2020 22:11	9,71	4	38,83	CHI
202012125540	GOIANIA	GN12345849	GOYA S1	22/12/2020 12:29	22/12/2020 16:01	22/12/2020 15:34	22/12/2020 16:01	0,46	246	114,12	CHI
202012127331	GAMELEIRA DE GOIAS	SV12033468-D	DAIA S2	22/12/2020 12:29	22/12/2020 23:47	22/12/2020 12:29	22/12/2020 23:47	11,29	15	169,37	CHI
202012127331	SILVANIA	SV12033468-D	DAIA S2	22/12/2020 12:29	22/12/2020 23:47	22/12/2020 12:29	22/12/2020 23:47	11,29	128	1445,26	CHI
202012125035	NIQUELANDIA	NQ11202062	URUACU	22/12/2020 12:30	23/12/2020 01:17	22/12/2020 12:30	23/12/2020 01:17	12,78	74	945,39	CHI
202012125058	FAZENDA NOVA	FN12013300	FIRMINOPOLIS S2	22/12/2020 12:30	23/12/2020 16:45	22/12/2020 12:30	23/12/2020 08:53	20,39	8	163,12	CHI
202012125058	FAZENDA NOVA	FN12013300	FIRMINOPOLIS S2	22/12/2020 12:30	23/12/2020 16:45	22/12/2020 12:30	23/12/2020 16:45	28,25	1	28,25	CHI
202012125058	FAZENDA NOVA	FN12013300	FIRMINOPOLIS S2	22/12/2020 12:30	23/12/2020 16:45	23/12/2020 08:56	23/12/2020 16:45	7,82	8	62,58	CHI
202012125116	MINEIROS	MY12257474	PARQUE DAS EMAS	22/12/2020 12:30	22/12/2020 14:30	22/12/2020 12:30	22/12/2020 14:30	2,01	251	504,44	CHI
202012123934	IPAMERI	IP12071444	IPAMERI	22/12/2020 12:31	22/12/2020 18:07	22/12/2020 12:31	22/12/2020 18:07	5,59	15	83,80	CHI
202012123934	CORUMBAIBA	IP12071444	IPAMERI	22/12/2020 12:31	22/12/2020 18:07	22/12/2020 12:31	22/12/2020 18:07	5,59	3	16,76	CHI
202012125037	SAO LUIZ DO NORTE	7137240	ITAPACI	22/12/2020 12:31	22/12/2020 16:04	22/12/2020 12:31	22/12/2020 16:04	3,55	1	3,55	CHI
202012125051	PLANALTINA	PB12281764	PADRE BERNARDO	22/12/2020 12:34	22/12/2020 18:14	22/12/2020 12:34	22/12/2020 18:14	5,66	13	73,53	CHI
202012125052	CORREGO DO OURO	CO12229147	SAO LUIZ DOS MONTES BELOS	22/12/2020 12:34	22/12/2020 18:53	22/12/2020 12:34	22/12/2020 18:53	6,30	1	6,30	CHI
202012125157	MARA ROSA	LC12050751	MARA ROSA	22/12/2020 12:35	22/12/2020 18:45	22/12/2020 12:35	22/12/2020 18:45	6,17	5	30,83	CHI
202012125157	AMARALINA	LC12050751	MARA ROSA	22/12/2020 12:35	22/12/2020 18:45	22/12/2020 12:35	22/12/2020 18:45	6,17	12	73,99	CHI
202012125061	LUZIANIA	LZ12370854	MARAJOARA	22/12/2020 12:36	22/12/2020 14:24	22/12/2020 12:36	22/12/2020 14:24	1,80	5	8,99	CHI
202012130247	VILA PROPICIO	PV12069121	GOIANESIA S1	22/12/2020 12:36	24/12/2020 15:30	22/12/2020 12:36	23/12/2020 11:59	23,37	5	116,84	CHI

202012130247	VILA PROPICIO	BA12210719	GOIANESIA S1	22/12/2020 12:36	24/12/2020 15:30	22/12/2020 12:36	23/12/2020 15:46	27,15	9	244,37	CHI
202012130247	VILA PROPICIO	BA12210719	GOIANESIA S1	22/12/2020 12:36	24/12/2020 15:30	23/12/2020 12:25	23/12/2020 15:46	3,35	3	10,05	CHI
202012130247	VILA PROPICIO	BA12210719	GOIANESIA S1	22/12/2020 12:36	24/12/2020 15:30	22/12/2020 12:36	23/12/2020 23:04	34,47	4	137,87	CHI
202012130247	BARRO ALTO	BA12210719	GOIANESIA S1	22/12/2020 12:36	24/12/2020 15:30	22/12/2020 12:36	23/12/2020 23:04	34,47	1	34,47	CHI
202012130247	VILA PROPICIO	BA12210719	GOIANESIA S1	22/12/2020 12:36	24/12/2020 15:30	23/12/2020 21:16	23/12/2020 23:04	1,81	12	21,74	CHI
202012130247	VILA PROPICIO	BA12210719	GOIANESIA S1	22/12/2020 12:36	24/12/2020 15:30	24/12/2020 08:30	24/12/2020 14:42	6,20	16	99,28	CHI
202012130247	BARRO ALTO	BA12210719	GOIANESIA S1	22/12/2020 12:36	24/12/2020 15:30	24/12/2020 08:30	24/12/2020 14:42	6,20	1	6,20	CHI
202012130247	VILA PROPICIO	BA12210719	GOIANESIA S1	22/12/2020 12:36	24/12/2020 15:30	22/12/2020 12:36	24/12/2020 15:30	50,89	1	50,89	CHI
202012125080	CRISTALINA	KR11170188	CRISTALINA S1	22/12/2020 12:39	22/12/2020 16:15	22/12/2020 12:39	22/12/2020 16:15	3,60	20	72,04	CHI
202012126715	JUSSARA	JR21289293	JUSSARA	22/12/2020 12:39	23/12/2020 17:27	22/12/2020 12:39	23/12/2020 17:27	28,80	2	57,61	CHI
202012125195	LUZIANIA	LZ12000495	MARAJOARA	22/12/2020 12:41	22/12/2020 15:18	22/12/2020 12:41	22/12/2020 15:18	2,60	12	31,24	CHI
202012125098	CHAPADAO DO CEU	10024988357	CHAPADAO DO CEU	22/12/2020 12:44	23/12/2020 00:57	22/12/2020 12:44	23/12/2020 00:57	12,22	1	12,22	CHI
202012125109	ALVORADA DO NORTE	AQ12293292	IACIARA S2	22/12/2020 12:45	22/12/2020 13:45	22/12/2020 12:45	22/12/2020 13:45	0,99	1	0,99	CHI
202012126963	NIQUELANDIA	NQ12281633	BARRO ALTO	22/12/2020 12:45	25/12/2020 13:33	22/12/2020 12:45	25/12/2020 13:33	72,79	4	291,17	CHI
202012125206	IPORA	IR12259526	IPORA	22/12/2020 12:47	22/12/2020 15:30	22/12/2020 12:47	22/12/2020 15:30	2,71	14	38,00	CHI
202012128480	NIQUELANDIA	NQ12378064	NIQUELANDIA SUBTRANSMISSAO	22/12/2020 12:47	23/12/2020 15:02	22/12/2020 12:47	23/12/2020 15:02	26,24	5	131,21	CHI
202012125141	CRIXAS	CX12181366	SANTA TEREZINHA	22/12/2020 12:50	22/12/2020 17:03	22/12/2020 12:50	22/12/2020 17:03	4,20	4	16,81	CHI
202012125150	GOIANIA	GN11043400	CAMPINAS S1	22/12/2020 12:53	22/12/2020 15:28	22/12/2020 12:53	22/12/2020 15:28	2,58	80	206,27	CHI
202012125190	LEOPOLDO DE BULHOES	LB12000624	DAIA S1	22/12/2020 12:53	23/12/2020 07:30	22/12/2020 12:53	23/12/2020 07:30	18,61	33	614,15	CHI
202012125409	NOVO GAMA	SN12290826	PACAEMBU S1	22/12/2020 12:54	22/12/2020 19:46	22/12/2020 12:54	22/12/2020 19:46	6,87	4	27,47	CHI
202012125409	SANTO ANTONIO DO DESCOBERTO	SN12290826	PACAEMBU S1	22/12/2020 12:54	22/12/2020 19:46	22/12/2020 12:54	22/12/2020 19:46	6,87	17	116,74	CHI
202012125169	HIDROLANDIA	HD12000067	INDEPENDENCIA S1	22/12/2020 12:56	23/12/2020 09:49	22/12/2020 12:56	23/12/2020 09:49	20,87	11	229,61	CHI
202012125169	ARAGOIANIA	HD12000067	INDEPENDENCIA S1	22/12/2020 12:56	23/12/2020 09:49	22/12/2020 12:56	23/12/2020 09:49	20,87	5	104,37	CHI
202012124290	MINEIROS	10029225637	PARQUE DAS EMAS	22/12/2020 12:57	22/12/2020 14:34	22/12/2020 12:57	22/12/2020 14:34	1,60	1	1,60	CHI
202012125170	APARECIDA DE GOIANIA	10022934993	INDEPENDENCIA S1	22/12/2020 12:57	22/12/2020 21:54	22/12/2020 12:57	22/12/2020 21:54	8,96	1	8,96	CHI
202012127829	NOVA CRIXAS	NA12091692	NOVA CRIXAS	22/12/2020 12:57	23/12/2020 02:23	22/12/2020 12:57	23/12/2020 02:23	13,42	23	308,67	CHI
202012125575	CACU	CA12013274	CACHOEIRA ALTA	22/12/2020 12:59	22/12/2020 15:22	22/12/2020 12:59	22/12/2020 15:22	2,38	6	14,29	CHI
202012125637	LUZIANIA	LZ12059742	CRISTALINA S2	22/12/2020 12:59	22/12/2020 16:26	22/12/2020 12:59	22/12/2020 16:26	3,46	5	17,29	CHI
202012124750	CATALAO	OU12190458RE	CATALAO S1	22/12/2020 13:01	22/12/2020 19:03	22/12/2020 13:01	22/12/2020 19:03	6,02	8	48,14	CHI
202012124750	OUVIDOR	OU12190458RE	CATALAO S1	22/12/2020 13:01	22/12/2020 19:03	22/12/2020 13:01	22/12/2020 19:03	6,02	25	150,44	CHI
202012126037	ACREUNA	TD12025737	RIO DOS BOIS	22/12/2020 13:01	22/12/2020 18:32	22/12/2020 13:01	22/12/2020 18:32	5,53	26	143,73	CHI
202012126037	TURVELANDIA	TD12025737	RIO DOS BOIS	22/12/2020 13:01	22/12/2020 18:32	22/12/2020 13:01	22/12/2020 18:32	5,53	66	364,85	CHI
202012126037	SANTA HELENA DE GOIAS	TD12025737	RIO DOS BOIS	22/12/2020 13:01	22/12/2020 18:32	22/12/2020 13:01	22/12/2020 18:32	5,53	18	99,51	CHI
202012125237	CABECEIRAS	CW10401456	ITIQUEIRA	22/12/2020 13:02	22/12/2020 19:37	22/12/2020 13:02	22/12/2020 18:29	5,45	34	185,18	CHI
202012125237	CABECEIRAS	CW10401456	ITIQUEIRA	22/12/2020 13:02	22/12/2020 19:37	22/12/2020 13:02	22/12/2020 19:18	6,26	14	87,60	CHI
202012125237	CABECEIRAS	CW10401456	ITIQUEIRA	22/12/2020 13:02	22/12/2020 19:37	22/12/2020 19:25	22/12/2020 19:33	0,13	48	6,07	CHI
202012125237	CABECEIRAS	CW12344410	ITIQUEIRA	22/12/2020 13:02	22/12/2020 19:37	22/12/2020 13:02	22/12/2020 19:37	6,57	6	39,45	CHI
202012125212	DISTRITO FEDERAL	TH12013600RE	CATALAO S1	22/12/2020 13:03	22/12/2020 18:26	22/12/2020 13:03	22/12/2020 18:26	5,37	1	5,37	CHI
202012125212	CUMARI	TH12013600RE	CATALAO S1	22/12/2020 13:03	22/12/2020 18:26	22/12/2020 13:03	22/12/2020 18:26	5,37	0	0,00	CHI
202012125212	TRES RANCHOS	TH12013600RE	CATALAO S1	22/12/2020 13:03	22/12/2020 18:26	22/12/2020 13:03	22/12/2020 18:26	5,37	127	682,20	CHI
202012125212	CATALAO	TH12013600RE	CATALAO S1	22/12/2020 13:03	22/12/2020 18:26	22/12/2020 13:03	22/12/2020 18:26	5,37	227	1219,37	CHI
202012125272	SANCLERLANDIA	O2020414	FIRMINOPOLIS S2	22/12/2020 13:08	22/12/2020 14:19	22/12/2020 13:08	22/12/2020 13:31	0,39	14	5,50	CHI
202012125272	BURITI DE GOIAS	O2020414	FIRMINOPOLIS S2	22/12/2020 13:08	22/12/2020 14:19	22/12/2020 13:08	22/12/2020 13:32	0,41	26	10,74	CHI
202012125272	SANCLERLANDIA	O2020414	FIRMINOPOLIS S2	22/12/2020 13:08	22/12/2020 14:19	22/12/2020 13:08	22/12/2020 13:32	0,41	20	8,26	CHI
202012125272	BURITI DE GOIAS	O2020414	FIRMINOPOLIS S2	22/12/2020 13:08	22/12/2020 14:19	22/12/2020 13:08	22/12/2020 13:38	0,51	583	298,46	CHI
202012125272	SAO LUIS DE MONTES BELOS	O2020414	FIRMINOPOLIS S2	22/12/2020 13:08	22/12/2020 14:19	22/12/2020 13:08	22/12/2020 14:08	1,01	16	16,24	CHI
202012125272	FIRMINOPOLIS	O2020414	FIRMINOPOLIS S2	22/12/2020 13:08	22/12/2020 14:19	22/12/2020 13:08	22/12/2020 14:08	1,01	1	1,01	CHI
202012125272	SANCLERLANDIA	O2020414	FIRMINOPOLIS S2	22/12/2020 13:08	22/12/2020 14:19	22/12/2020 13:08	22/12/2020 14:11	1,06	8	8,49	CHI
202012125272	SANCLERLANDIA	O2020414	FIRMINOPOLIS S2	22/12/2020 13:08	22/12/2020 14:19	22/12/2020 13:08	22/12/2020 14:11	1,06	1	1,06	CHI
202012125272	BURITI DE GOIAS	O2020414	FIRMINOPOLIS S2	22/12/2020 13:08	22/12/2020 14:19	22/12/2020 13:08	22/12/2020 14:11	1,06	319	338,49	CHI
202012125272	SANCLERLANDIA	O2020414	FIRMINOPOLIS S2	22/12/2020 13:08	22/12/2020 14:19	22/12/2020 13:08	22/12/2020 14:11	1,06	734	778,86	CHI

202012125272	BURITI DE GOIAS	02020414	FIRMINOPOLIS S2	22/12/2020 13:08	22/12/2020 14:19	22/12/2020 13:08	22/12/2020 14:11	1,06	2	2,12	CHI
202012125272	BURITI DE GOIAS	02020414	FIRMINOPOLIS S2	22/12/2020 13:08	22/12/2020 14:19	22/12/2020 13:08	22/12/2020 14:11	1,06	591	627,12	CHI
202012125272	MOSSAMEDES	02020414	FIRMINOPOLIS S2	22/12/2020 13:08	22/12/2020 14:19	22/12/2020 13:08	22/12/2020 14:11	1,06	4	4,24	CHI
202012125272	SANCLERLANDIA	02020414	FIRMINOPOLIS S2	22/12/2020 13:08	22/12/2020 14:19	22/12/2020 13:08	22/12/2020 14:11	1,06	18	19,10	CHI
202012125272	SAO LUIS DE MONTES BELOS	02020414	FIRMINOPOLIS S2	22/12/2020 13:08	22/12/2020 14:19	22/12/2020 13:08	22/12/2020 14:11	1,06	2	2,12	CHI
202012125272	SANCLERLANDIA	02020414	FIRMINOPOLIS S2	22/12/2020 13:08	22/12/2020 14:19	22/12/2020 13:08	22/12/2020 14:11	1,06	3088	3276,71	CHI
202012125272	MOSSAMEDES	02020414	FIRMINOPOLIS S2	22/12/2020 13:08	22/12/2020 14:19	22/12/2020 13:08	22/12/2020 14:11	1,06	30	31,83	CHI
202012125272	SAO LUIS DE MONTES BELOS	02020414	FIRMINOPOLIS S2	22/12/2020 13:08	22/12/2020 14:19	22/12/2020 13:08	22/12/2020 14:11	1,06	26	27,59	CHI
202012125272	SANCLERLANDIA	02020414	FIRMINOPOLIS S2	22/12/2020 13:08	22/12/2020 14:19	22/12/2020 13:08	22/12/2020 14:11	1,06	7	7,43	CHI
202012125272	MOSSAMEDES	02020414	FIRMINOPOLIS S2	22/12/2020 13:08	22/12/2020 14:19	22/12/2020 13:08	22/12/2020 14:11	1,06	103	109,29	CHI
202012125272	MOSSAMEDES	02020414	FIRMINOPOLIS S2	22/12/2020 13:08	22/12/2020 14:19	22/12/2020 13:08	22/12/2020 14:11	1,06	4	4,24	CHI
202012125272	MOSSAMEDES	02020414	FIRMINOPOLIS S2	22/12/2020 13:08	22/12/2020 14:19	22/12/2020 13:08	22/12/2020 14:11	1,06	1884	1999,13	CHI
202012125272	SANCLERLANDIA	02020414	FIRMINOPOLIS S2	22/12/2020 13:08	22/12/2020 14:19	22/12/2020 13:08	22/12/2020 14:11	1,06	11	11,67	CHI
202012125272	SANCLERLANDIA	02020414	FIRMINOPOLIS S2	22/12/2020 13:08	22/12/2020 14:19	22/12/2020 13:08	22/12/2020 14:11	1,05	1	1,05	CHI
202012125272	SAO LUIS DE MONTES BELOS	02020414	FIRMINOPOLIS S2	22/12/2020 13:08	22/12/2020 14:19	22/12/2020 13:08	22/12/2020 14:19	1,18	66	78,10	CHI
202012125272	ANICUNS	02020414	FIRMINOPOLIS S2	22/12/2020 13:08	22/12/2020 14:19	22/12/2020 13:08	22/12/2020 14:19	1,18	78	92,30	CHI
202012125272	SAO LUIS DE MONTES BELOS	02020414	FIRMINOPOLIS S2	22/12/2020 13:08	22/12/2020 14:19	22/12/2020 13:08	22/12/2020 14:19	1,18	142	168,03	CHI
202012125272	ADELANDIA	02020414	FIRMINOPOLIS S2	22/12/2020 13:08	22/12/2020 14:19	22/12/2020 13:08	22/12/2020 14:19	1,18	70	82,83	CHI
202012125272	AURILANDIA	02020414	FIRMINOPOLIS S2	22/12/2020 13:08	22/12/2020 14:19	22/12/2020 13:08	22/12/2020 14:19	1,18	1	1,18	CHI
202012125272	TURVANIA	02020414	FIRMINOPOLIS S2	22/12/2020 13:08	22/12/2020 14:19	22/12/2020 13:08	22/12/2020 14:19	1,18	2	2,37	CHI
202012125272	SANCLERLANDIA	02020414	FIRMINOPOLIS S2	22/12/2020 13:08	22/12/2020 14:19	22/12/2020 13:08	22/12/2020 14:19	1,18	30	35,50	CHI
202012125272	ADELANDIA	02020414	FIRMINOPOLIS S2	22/12/2020 13:08	22/12/2020 14:19	22/12/2020 13:08	22/12/2020 14:19	1,18	1011	1196,35	CHI
202012125272	ADELANDIA	02020414	FIRMINOPOLIS S2	22/12/2020 13:08	22/12/2020 14:19	22/12/2020 13:08	22/12/2020 14:19	1,18	5	5,92	CHI
202012125272	SAO LUIS DE MONTES BELOS	02020414	FIRMINOPOLIS S2	22/12/2020 13:08	22/12/2020 14:19	22/12/2020 13:08	22/12/2020 14:19	1,18	46	54,43	CHI
202012125272	MOSSAMEDES	02020414	FIRMINOPOLIS S2	22/12/2020 13:08	22/12/2020 14:19	22/12/2020 13:08	22/12/2020 14:19	1,18	5	5,92	CHI
202012125453	VALPARAISO DE GOIAS	LZ12000477	MARAJOARA	22/12/2020 13:08	22/12/2020 14:58	22/12/2020 13:08	22/12/2020 14:58	1,82	800	1455,56	CHI
202012125276	CASTELANDIA	DM12028088	RIO DOS BOIS	22/12/2020 13:12	22/12/2020 21:23	22/12/2020 13:12	22/12/2020 21:23	8,17	5	40,83	CHI
202012127983	BONOPOLIS	PO12090602	MARA ROSA	22/12/2020 13:12	23/12/2020 16:02	22/12/2020 13:12	23/12/2020 16:02	26,82	2	53,64	CHI
202012127983	PORANGATU	PO12090602	MARA ROSA	22/12/2020 13:12	23/12/2020 16:02	22/12/2020 13:12	23/12/2020 16:02	26,82	65	1743,43	CHI
202012125290	MOSSAMEDES	MD12089244	ITABERAII S2	22/12/2020 13:14	22/12/2020 17:52	22/12/2020 13:14	22/12/2020 17:52	4,63	15	69,39	CHI
202012126878	CUMARI	CY12061105RE	CATALAO S2	22/12/2020 13:14	22/12/2020 19:03	22/12/2020 13:14	22/12/2020 19:03	5,80	21	121,82	CHI
202012125454	JARAGUA	JA12414669	JARAGUA	22/12/2020 13:16	22/12/2020 14:17	22/12/2020 13:16	22/12/2020 14:17	1,00	226	226,94	CHI
202012125304	ANAPOLIS	10031087289	ANAPOLIS UNIVERSITARIO S2	22/12/2020 13:19	22/12/2020 16:44	22/12/2020 13:19	22/12/2020 16:44	3,42	1	3,42	CHI
202012125692	BOM JESUS DE GOIAS	BJ12000207	CACHOEIRA DOURADA	22/12/2020 13:19	22/12/2020 16:44	22/12/2020 13:19	22/12/2020 16:44	3,42	4	13,69	CHI
202012125692	PANAMA	BJ12000207	CACHOEIRA DOURADA	22/12/2020 13:19	22/12/2020 16:44	22/12/2020 13:19	22/12/2020 16:44	3,42	2	6,85	CHI
202012125692	GOIATUBA	BJ12000207	CACHOEIRA DOURADA	22/12/2020 13:19	22/12/2020 16:44	22/12/2020 13:19	22/12/2020 16:44	3,42	1	3,42	CHI
202012125315	LUZIANIA	LZ12389561	PACAEMBU S2	22/12/2020 13:20	22/12/2020 21:44	22/12/2020 13:20	22/12/2020 21:00	7,65	1	7,65	CHI
202012125315	LUZIANIA	LZ12313802LD	PACAEMBU S2	22/12/2020 13:20	22/12/2020 21:44	22/12/2020 13:20	22/12/2020 21:44	8,40	17	142,72	CHI
202012128223	DOVERLANDIA	10031062235	CAIAPONIA	22/12/2020 13:21	23/12/2020 15:33	22/12/2020 13:21	23/12/2020 15:33	26,21	1	26,21	CHI
202012125322	ITUMBIARA	IT12033051	BOM JESUS DE GOIAS	22/12/2020 13:22	22/12/2020 19:58	22/12/2020 13:22	22/12/2020 19:58	6,58	1	6,58	CHI
202012125328	SAO JOAO D ALIANCA	JL12129981LD	SAO JOAO D ALIANCA	22/12/2020 13:23	22/12/2020 17:44	22/12/2020 13:23	22/12/2020 17:44	4,34	3	13,01	CHI
202012125473	LUZIANIA	LZ12330544	MARAJOARA	22/12/2020 13:23	22/12/2020 16:15	22/12/2020 13:23	22/12/2020 16:15	2,86	8	22,92	CHI
202012125331	ITAPURANGA	IK12227367	ITAPURANGA	22/12/2020 13:24	23/12/2020 09:23	22/12/2020 13:24	23/12/2020 09:23	19,98	1	19,98	CHI
202012125336	ANAPOLIS	10029787759	ANAPOLIS UNIVERSITARIO S2	22/12/2020 13:24	22/12/2020 19:48	22/12/2020 13:24	22/12/2020 19:48	6,40	1	6,40	CHI
202012127776	JATAI	JT12092395	JATAI S1	22/12/2020 13:24	23/12/2020 00:16	22/12/2020 13:24	23/12/2020 00:16	10,86	38	412,74	CHI
202012125349	ARAGARCAS	BM11369857	BOM JARDIM	22/12/2020 13:27	22/12/2020 17:42	22/12/2020 13:27	22/12/2020 17:42	4,25	1	4,25	CHI
202012125356	ACREUNA	EU12114599	ACREUNA	22/12/2020 13:27	22/12/2020 19:31	22/12/2020 13:27	22/12/2020 19:31	6,06	6	36,37	CHI
202012125982	AMARALINA	MU12391981	MARA ROSA	22/12/2020 13:35	22/12/2020 19:39	22/12/2020 13:35	22/12/2020 19:39	6,06	5	30,30	CHI
202012125982	MUTUNOPOLIS	MU12391981	MARA ROSA	22/12/2020 13:35	22/12/2020 19:39	22/12/2020 13:35	22/12/2020 19:39	6,06	5	30,30	CHI
202012127000	POSSE	PS12344418	IACIARA S1	22/12/2020 13:35	22/12/2020 20:46	22/12/2020 13:35	22/12/2020 20:46	7,17	41	294,06	CHI
202012125392	GOIANAPOLIS	GP11193112	DAIA S2	22/12/2020 13:36	22/12/2020 14:50	22/12/2020 13:36	22/12/2020 14:50	1,23	73	89,69	CHI

202012125400	CAIAPONIA	CP12316428	CAIAPONIA	22/12/2020 13:37	22/12/2020 18:47	22/12/2020 13:37	22/12/2020 18:47	5,15	4	20,61	CHI
202012125429	ARAGUAPAZ	AZ12238808	GOIAS	22/12/2020 13:43	22/12/2020 18:30	22/12/2020 13:43	22/12/2020 18:30	4,78	23	109,98	CHI
202012125429	FAINA	AZ12238808	GOIAS	22/12/2020 13:43	22/12/2020 18:30	22/12/2020 13:43	22/12/2020 18:30	4,78	1	4,78	CHI
202012125478	CEZARINA	CZ21349293	CEZARINA	22/12/2020 13:47	22/12/2020 16:33	22/12/2020 13:47	22/12/2020 16:33	2,75	1	2,75	CHI
202012125480	AGUAS LINDAS DE GOIAS	LA11148936	AGUAS LINDAS DE GOIAS S1	22/12/2020 13:48	22/12/2020 14:56	22/12/2020 13:48	22/12/2020 14:56	1,13	26	29,43	CHI
202012125918	PARANAIGUARA	PC12047562	QUIRINOPOLIS	22/12/2020 13:49	22/12/2020 23:22	22/12/2020 13:49	22/12/2020 23:22	9,54	21	200,33	CHI
202012125502	APORE	AE12196218	ITAJA S1	22/12/2020 13:51	22/12/2020 20:26	22/12/2020 13:51	22/12/2020 20:26	6,58	1	6,58	CHI
202012125506	LUZIANIA	LZ21399268	MARAJOARA	22/12/2020 13:52	22/12/2020 19:47	22/12/2020 13:52	22/12/2020 19:47	5,90	1	5,90	CHI
202012125520	SAO LUIS DE MONTES BELOS	500049361	SAO LUIZ DOS MONTES BELOS	22/12/2020 13:54	22/12/2020 19:58	22/12/2020 13:54	22/12/2020 19:58	6,06	1	6,06	CHI
202012126634	CRIXAS	CX12213047RE	SANTA TEREZINHA	22/12/2020 13:54	24/12/2020 11:34	22/12/2020 13:54	24/12/2020 11:34	45,67	41	1872,36	CHI
202012126634	SANTA TEREZINHA DE GOIAS	CX12213047RE	SANTA TEREZINHA	22/12/2020 13:54	24/12/2020 11:34	22/12/2020 13:54	24/12/2020 11:34	45,67	4	182,67	CHI
202012125645	GOIANESIA	GE12256024	GOIANESIA S2	22/12/2020 13:55	23/12/2020 14:50	22/12/2020 13:55	23/12/2020 14:50	24,93	11	274,22	CHI
202012125645	GOIANESIA	GE12256024	GOIANESIA S2	22/12/2020 13:55	23/12/2020 14:50	22/12/2020 22:44	23/12/2020 14:50	16,12	7	112,81	CHI
202012125615	ITAPACI	IW12081353	ITAPACI	22/12/2020 13:57	22/12/2020 15:49	22/12/2020 13:57	22/12/2020 15:49	1,86	24	44,69	CHI
202012125765	DOVERLANDIA	DV12241763	CAIAPONIA	22/12/2020 13:59	23/12/2020 13:30	22/12/2020 13:59	23/12/2020 13:30	23,51	3	70,54	CHI
202012125560	MINEIROS	MY12241799	PARQUE DAS EMAS	22/12/2020 14:00	22/12/2020 16:56	22/12/2020 14:00	22/12/2020 16:56	2,93	1	2,93	CHI
202012127539	CORUMBA DE GOIAS	AX13101833	CORUMBA	22/12/2020 14:03	23/12/2020 12:24	22/12/2020 14:03	23/12/2020 12:24	22,35	276	6167,53	CHI
202012127539	ALEXANIA	AX13101833	CORUMBA	22/12/2020 14:03	23/12/2020 12:24	23/12/2020 14:03	23/12/2020 12:24	22,35	10	223,46	CHI
202012127539	CORUMBA DE GOIAS	AX13101833	CORUMBA	22/12/2020 14:03	23/12/2020 12:24	23/12/2020 09:33	23/12/2020 12:24	2,85	55	157,02	CHI
202012127539	ALEXANIA	AX13101833	CORUMBA	22/12/2020 14:03	23/12/2020 12:24	23/12/2020 09:33	23/12/2020 12:24	2,85	12	34,26	CHI
202012125602	POSSE	PS12255382	IACIARA S2	22/12/2020 14:06	22/12/2020 18:08	22/12/2020 14:06	22/12/2020 18:08	4,02	38	152,76	CHI
202012125675	MONTIVIDIU DO NORTE	MX12203423	PORANGATU	22/12/2020 14:07	22/12/2020 16:58	22/12/2020 14:07	22/12/2020 16:58	2,85	17	48,45	CHI
202012125627	NOVA IGUAQUA DE GOIAS	NH12202112RE	SANTA TEREZINHA	22/12/2020 14:10	22/12/2020 16:29	22/12/2020 14:10	22/12/2020 16:29	2,30	6	13,81	CHI
202012125627	ALTO HORIZONTE	NH12202112RE	SANTA TEREZINHA	22/12/2020 14:10	22/12/2020 16:29	22/12/2020 14:10	22/12/2020 16:29	2,30	9	20,71	CHI
202012125686	MARA ROSA	UP12294696	NOVA CRIXAS	22/12/2020 14:10	23/12/2020 01:57	22/12/2020 14:10	22/12/2020 20:25	6,23	4	24,94	CHI
202012125686	MARA ROSA	UP12294696	NOVA CRIXAS	22/12/2020 14:10	23/12/2020 01:57	22/12/2020 14:10	23/12/2020 01:57	11,77	43	506,27	CHI
202012125686	UIRAPURU	UP12294696	NOVA CRIXAS	22/12/2020 14:10	23/12/2020 01:57	22/12/2020 14:10	23/12/2020 01:57	11,77	4	47,09	CHI
202012125686	AMARALINA	UP12294696	NOVA CRIXAS	22/12/2020 14:10	23/12/2020 01:57	22/12/2020 14:10	23/12/2020 01:57	11,77	51	600,45	CHI
202012125686	SANTA TEREZINHA DE GOIAS	UP12294696	NOVA CRIXAS	22/12/2020 14:10	23/12/2020 01:57	22/12/2020 14:10	23/12/2020 01:57	11,77	1	11,77	CHI
202012125752	FLORES DE GOIAS	FB12204157	FLORES DE GOIAS	22/12/2020 14:10	22/12/2020 17:30	22/12/2020 14:10	22/12/2020 17:30	3,32	13	43,18	CHI
202012126044	PIRANHAS	PH12380983	PIRANHAS	22/12/2020 14:10	22/12/2020 22:51	22/12/2020 14:10	22/12/2020 22:51	8,68	6	52,07	CHI
202012125630	TRINDADE	40240605	GOYA S2	22/12/2020 14:11	22/12/2020 17:06	22/12/2020 14:11	22/12/2020 17:06	2,92	1	2,92	CHI
202012126349	LUZIANIA	OZ21195213	PIRES DO RIO S2	22/12/2020 14:12	22/12/2020 23:02	22/12/2020 14:12	22/12/2020 23:02	8,83	1	8,83	CHI
202012125643	SAO MIGUEL DO ARAGUAIA	SM12137060	SAO MIGUEL DO ARAGUAIA	22/12/2020 14:13	22/12/2020 19:42	22/12/2020 14:13	22/12/2020 19:42	5,47	2	10,95	CHI
202012126174	PARANAIGUARA	PC12070705	QUIRINOPOLIS	22/12/2020 14:13	22/12/2020 18:57	22/12/2020 14:13	22/12/2020 18:57	4,72	36	169,93	CHI
202012125671	AGUAS LINDAS DE GOIAS	LA11146693	AGUAS LINDAS DE GOIAS S1	22/12/2020 14:17	22/12/2020 16:20	22/12/2020 14:17	22/12/2020 16:20	2,05	162	332,77	CHI
202012125672	ACREUNA	EU11271569	ACREUNA	22/12/2020 14:17	23/12/2020 02:50	22/12/2020 14:17	23/12/2020 02:50	12,54	98	1228,76	CHI
202012125673	ITAJA	IJ12000077	CACHOEIRA ALTA	22/12/2020 14:18	23/12/2020 05:04	22/12/2020 14:18	23/12/2020 05:04	14,77	2	29,53	CHI
202012125673	LAGOA SANTA	IJ12000077	CACHOEIRA ALTA	22/12/2020 14:18	23/12/2020 05:04	22/12/2020 14:18	23/12/2020 05:04	14,77	3	44,30	CHI
202012128107	SAO SIMAO	SO12261031	CACHOEIRA ALTA	22/12/2020 14:19	22/12/2020 23:39	22/12/2020 14:19	22/12/2020 23:39	9,32	2	18,64	CHI
202012125855	GOIANIA	GN12040771	XAVANTES	22/12/2020 14:24	22/12/2020 15:49	22/12/2020 14:24	22/12/2020 15:49	1,41	360	507,80	CHI
202012125708	GOIANDIRA	GD12160912	CATALAO S1	22/12/2020 14:25	22/12/2020 17:52	22/12/2020 14:25	22/12/2020 17:52	3,45	1	3,45	CHI
202012126005	ARAGARCAS	AG12334918	ARAGARCAS	22/12/2020 14:25	22/12/2020 17:49	22/12/2020 14:25	22/12/2020 17:49	3,39	3	10,18	CHI
202012125717	GOIANIA	GN12001501	XAVANTES	22/12/2020 14:27	22/12/2020 19:28	22/12/2020 14:27	22/12/2020 19:28	5,01	224	1122,74	CHI
202012125738	VICENTINOPOLIS	VI12335578	VICENTINOPOLIS	22/12/2020 14:28	22/12/2020 19:03	22/12/2020 14:28	22/12/2020 19:03	4,57	4	18,29	CHI
202012125815	QUIRINOPOLIS	QI32036476LD	QUIRINOPOLIS	22/12/2020 14:28	22/12/2020 23:50	22/12/2020 14:28	22/12/2020 23:50	9,37	70	655,61	CHI
202012125815	QUIRINOPOLIS	QI32036476LD	QUIRINOPOLIS	22/12/2020 14:28	22/12/2020 23:50	22/12/2020 19:38	22/12/2020 23:50	4,20	1	4,20	CHI
202012125748	GOIANESIA	GE10396193	GOIANESIA S2	22/12/2020 14:30	23/12/2020 12:50	23/12/2020 03:57	23/12/2020 04:48	0,84	69	57,71	CHI
202012125748	VILA PROPICIO	GE10396193	GOIANESIA S2	22/12/2020 14:30	23/12/2020 12:50	23/12/2020 03:57	23/12/2020 04:48	0,84	50	41,82	CHI
202012125748	GOIANESIA	GE21258454	GOIANESIA S2	22/12/2020 14:30	23/12/2020 12:50	22/12/2020 14:30	23/12/2020 12:50	22,33	1	22,33	CHI
202012125778	NOVA ROMA	ND12392238	IACIARA S2	22/12/2020 14:32	22/12/2020 17:29	22/12/2020 14:32	22/12/2020 17:29	2,94	244	716,41	CHI

202012127607	LUZIANIA	OZ12402562RE	PIRES DO RIO S2	22/12/2020 14:32	22/12/2020 23:02	22/12/2020 14:32	22/12/2020 23:02	8,50	133	1130,72	CHI
202012127607	ORIZONA	OZ12402562RE	PIRES DO RIO S2	22/12/2020 14:32	22/12/2020 23:02	22/12/2020 14:32	22/12/2020 23:02	8,50	7	59,51	CHI
202012126315	PANAMA	IT12305396	CACHOEIRA DOURADA	22/12/2020 14:33	22/12/2020 23:34	22/12/2020 14:33	22/12/2020 23:34	9,01	5	45,06	CHI
202012126315	ITUMBUIARA	IT12305396	CACHOEIRA DOURADA	22/12/2020 14:33	22/12/2020 23:34	22/12/2020 14:33	22/12/2020 23:34	9,01	23	207,29	CHI
202012125807	MINACU	4020040450	MINACU	22/12/2020 14:35	22/12/2020 17:27	22/12/2020 14:35	22/12/2020 17:27	2,86	1	2,86	CHI
202012125847	APARECIDA DE GOIANIA	AP11007346	INDEPENDENCIA S1	22/12/2020 14:40	22/12/2020 17:30	22/12/2020 14:40	22/12/2020 17:30	2,83	96	271,92	CHI
202012125857	JATAI	JT18191724TS	JATAI S2	22/12/2020 14:41	22/12/2020 16:39	22/12/2020 14:41	22/12/2020 16:39	1,96	34	66,52	CHI
202012125878	CACHOEIRA ALTA	CA12075141	CACHOEIRA ALTA	22/12/2020 14:44	22/12/2020 16:34	22/12/2020 14:44	22/12/2020 16:34	1,83	10	18,30	CHI
202012126346	APARECIDA DE GOIANIA	AP11161821	ANHANGUERA	22/12/2020 14:44	22/12/2020 16:42	22/12/2020 14:44	22/12/2020 16:42	1,96	213	416,59	CHI
202012125889	NOVA ROMA	ND11078486	IACIARA S2	22/12/2020 14:45	22/12/2020 19:09	22/12/2020 14:45	22/12/2020 19:09	4,39	48	210,79	CHI
202012126577	INHUMAS	AR12247240	ARACU	22/12/2020 14:45	22/12/2020 19:38	22/12/2020 14:45	22/12/2020 19:38	4,87	9	43,84	CHI
202012125904	RIO VERDE	630137328	RIO VERDE S1	22/12/2020 14:47	23/12/2020 08:33	22/12/2020 14:47	23/12/2020 08:33	17,77	1	17,77	CHI
202012125905	TRINDADE	TR21326085	GOYA S2	22/12/2020 14:47	22/12/2020 20:41	22/12/2020 14:47	22/12/2020 20:41	5,89	2	11,79	CHI
202012127024	EDEIA	EA12237745	EDEIA	22/12/2020 14:48	23/12/2020 08:40	22/12/2020 14:48	23/12/2020 08:40	17,86	9	160,73	CHI
202012125992	FLORES DE GOIAS	FB10408313	IACIARA S2	22/12/2020 14:49	22/12/2020 15:14	22/12/2020 14:49	22/12/2020 14:53	0,08	198	14,90	CHI
202012125992	ALVORADA DO NORTE	00010414	IACIARA S2	22/12/2020 14:49	22/12/2020 15:14	22/12/2020 14:49	22/12/2020 15:12	0,40	271	107,87	CHI
202012125992	SITIO D ABADIA	00010414	IACIARA S2	22/12/2020 14:49	22/12/2020 15:14	22/12/2020 14:49	22/12/2020 15:12	0,40	27	10,75	CHI
202012125992	FLORES DE GOIAS	00010414	IACIARA S2	22/12/2020 14:49	22/12/2020 15:14	22/12/2020 14:49	22/12/2020 15:12	0,40	40	15,92	CHI
202012125992	SIMOLANDIA	00010414	IACIARA S2	22/12/2020 14:49	22/12/2020 15:14	22/12/2020 14:49	22/12/2020 15:12	0,40	1	0,40	CHI
202012125992	IACIARA	00010414	IACIARA S2	22/12/2020 14:49	22/12/2020 15:14	22/12/2020 14:49	22/12/2020 15:12	0,40	1	0,40	CHI
202012125992	ALVORADA DO NORTE	FB10410987	IACIARA S2	22/12/2020 14:49	22/12/2020 15:14	22/12/2020 14:50	22/12/2020 15:12	0,38	24	9,06	CHI
202012125992	FLORES DE GOIAS	00010414	IACIARA S2	22/12/2020 14:49	22/12/2020 15:14	22/12/2020 14:51	22/12/2020 15:12	0,37	1	0,37	CHI
202012125992	VILA BOA	00010414	IACIARA S2	22/12/2020 14:49	22/12/2020 15:14	22/12/2020 14:49	22/12/2020 15:14	0,42	3	1,26	CHI
202012125992	FORMOSA	00010414	IACIARA S2	22/12/2020 14:49	22/12/2020 15:14	22/12/2020 14:49	22/12/2020 15:14	0,42	1	0,42	CHI
202012125992	SITIO D ABADIA	00010414	IACIARA S2	22/12/2020 14:49	22/12/2020 15:14	22/12/2020 14:49	22/12/2020 15:14	0,42	120	50,30	CHI
202012125992	FLORES DE GOIAS	00010414	IACIARA S2	22/12/2020 14:49	22/12/2020 15:14	22/12/2020 14:49	22/12/2020 15:14	0,42	1054	441,80	CHI
202012125992	FLORES DE GOIAS	FB10407015	IACIARA S2	22/12/2020 14:49	22/12/2020 15:14	22/12/2020 14:51	22/12/2020 15:14	0,39	1	0,39	CHI
202012125925	AMARALINA	LC12276051	SAO MIGUEL DO ARAGUAIA	22/12/2020 14:50	22/12/2020 15:52	22/12/2020 14:50	22/12/2020 15:52	1,03	10	10,29	CHI
202012125931	SAO DOMINGOS	SD12218642	SAO DOMINGOS	22/12/2020 14:50	22/12/2020 17:27	22/12/2020 14:50	22/12/2020 17:27	2,60	90	234,18	CHI
202012126022	MARA ROSA	MQ12380741	SANTA TEREZINHA	22/12/2020 14:50	22/12/2020 18:48	22/12/2020 14:50	22/12/2020 18:48	3,96	12	47,46	CHI
202012123497	EDEIA	EA12014355	EDEIA	22/12/2020 14:51	22/12/2020 23:00	22/12/2020 14:51	22/12/2020 23:00	8,15	2	16,30	CHI
202012125932	RIO QUENTE	RQ12153452	RIO QUENTE	22/12/2020 14:51	22/12/2020 21:46	22/12/2020 14:51	22/12/2020 21:46	6,91	269	1860,13	CHI
202012125951	MORRINHOS	MR12122180	MORRINHOS	22/12/2020 14:52	22/12/2020 18:26	22/12/2020 14:52	22/12/2020 18:26	3,56	6	21,34	CHI
202012125973	AGUA FRIA DE GOIAS	TL12193669	SAO JOAO D ALIANCA	22/12/2020 14:55	22/12/2020 18:32	22/12/2020 14:55	22/12/2020 18:32	3,60	6	21,63	CHI
202012127575	PARANAIGUARA	QI12360936	QUIRINOPOLIS	22/12/2020 14:55	22/12/2020 19:15	22/12/2020 14:55	22/12/2020 19:15	4,32	6	25,91	CHI
202012125978	CRISTALINA	KR12133611	CRISTALINA S2	22/12/2020 14:56	22/12/2020 18:43	22/12/2020 14:56	22/12/2020 18:43	3,78	2	7,56	CHI
202012127514	ABADIANIA	AA12285384	ANAPOLIS UNIVERSITARIO S1	22/12/2020 14:56	22/12/2020 21:03	22/12/2020 14:56	22/12/2020 21:03	6,11	136	830,85	CHI
202012127514	GAMELEIRA DE GOIAS	AA12285384	ANAPOLIS UNIVERSITARIO S1	22/12/2020 14:56	22/12/2020 21:03	22/12/2020 14:56	22/12/2020 21:03	6,11	1	6,11	CHI
202012127956	ORIZONA	LZ12109848	VIANOPOLIS	22/12/2020 14:56	22/12/2020 23:01	22/12/2020 14:56	22/12/2020 23:01	8,07	1	8,07	CHI
202012127956	LUZIANIA	LZ12109848	VIANOPOLIS	22/12/2020 14:56	22/12/2020 23:01	22/12/2020 14:56	22/12/2020 23:01	8,07	23	185,72	CHI
202012126010	ANAPOLIS	AN12382121	DAIA S1	22/12/2020 14:58	22/12/2020 19:00	22/12/2020 14:58	22/12/2020 19:00	4,02	6	24,15	CHI
202012126347	IPORA	IV12026057	IPORA	22/12/2020 14:58	22/12/2020 16:45	22/12/2020 14:58	22/12/2020 16:45	1,78	47	83,79	CHI
202012126347	AMORINOPOLIS	IV12026057	IPORA	22/12/2020 14:58	22/12/2020 16:45	22/12/2020 14:58	22/12/2020 16:45	1,78	8	14,26	CHI
202012126347	IVOLANDIA	IV12026057	IPORA	22/12/2020 14:58	22/12/2020 16:45	22/12/2020 14:58	22/12/2020 16:45	1,78	13	23,18	CHI
202012126034	CRISTALINA	KR12183710	CRISTALINA S2	22/12/2020 15:01	22/12/2020 23:02	22/12/2020 15:01	22/12/2020 23:02	8,01	1	8,01	CHI
202012126367	LUZIANIA	LZ12189760	VIANOPOLIS	22/12/2020 15:01	22/12/2020 19:23	22/12/2020 15:01	22/12/2020 19:23	4,36	27	117,73	CHI
202012126084	ANAPOLIS	AN12000026	ANAPOLIS UNIVERSITARIO S2	22/12/2020 15:05	22/12/2020 19:01	22/12/2020 15:05	22/12/2020 19:01	3,93	235	923,94	CHI
202012126097	COCALZINHO DE GOIAS	ZN12375219	AGUAS LINDAS DE GOIAS S2	22/12/2020 15:06	22/12/2020 17:48	22/12/2020 15:06	22/12/2020 17:48	2,69	25	67,22	CHI
202012126477	GOUVELANDIA	QI12301516	QUIRINOPOLIS	22/12/2020 15:06	22/12/2020 17:33	22/12/2020 15:06	22/12/2020 17:33	2,45	8	19,56	CHI
202012126389	AMARALINA	LC12270203	SAO MIGUEL DO ARAGUAIA	22/12/2020 15:07	23/12/2020 03:36	22/12/2020 15:07	23/12/2020 03:36	12,49	9	112,38	CHI
202012126520	IPAMERI	IP12376252	CRISTALINA S2	22/12/2020 15:07	22/12/2020 22:43	22/12/2020 15:07	22/12/2020 22:43	7,59	20	151,87	CHI



202012126123	GOIANIA	GN11001163	CAMPINAS S3	22/12/2020 15:09	22/12/2020 19:49	22/12/2020 15:09	22/12/2020 19:49	4,65	123	572,12	CHI
202012126165	LUZIANIA	NJ10406840	PACAEMBU S2	22/12/2020 15:10	22/12/2020 21:44	22/12/2020 15:10	22/12/2020 16:45	1,58	2	3,17	CHI
202012126165	LUZIANIA	NJ10406840	PACAEMBU S2	22/12/2020 15:10	22/12/2020 21:44	22/12/2020 15:10	22/12/2020 17:35	2,41	32	77,12	CHI
202012126165	NOVO GAMA	NJ10406840	PACAEMBU S2	22/12/2020 15:10	22/12/2020 21:44	22/12/2020 15:10	22/12/2020 17:35	2,41	15	36,15	CHI
202012126165	NOVO GAMA	NJ12305036	PACAEMBU S2	22/12/2020 15:10	22/12/2020 21:44	22/12/2020 15:10	22/12/2020 21:00	5,82	34	197,97	CHI
202012126165	LUZIANIA	NJ12305036	PACAEMBU S2	22/12/2020 15:10	22/12/2020 21:44	22/12/2020 15:10	22/12/2020 21:00	5,82	30	174,68	CHI
202012126165	LUZIANIA	LZ12313802LD	PACAEMBU S2	22/12/2020 15:10	22/12/2020 21:44	22/12/2020 15:10	22/12/2020 21:44	6,56	51	334,79	CHI
202012126165	LUZIANIA	LZ12313802LD	PACAEMBU S2	22/12/2020 15:10	22/12/2020 21:44	22/12/2020 15:11	22/12/2020 21:44	6,56	1	6,56	CHI
202012126435	ITAGUARU	IC12065281	ITABERAI S1	22/12/2020 15:11	22/12/2020 17:11	22/12/2020 15:11	22/12/2020 17:11	1,98	3	5,95	CHI
202012126435	HEITORAI	IC12065281	ITABERAI S1	22/12/2020 15:11	22/12/2020 17:11	22/12/2020 15:11	22/12/2020 17:11	1,98	7	13,89	CHI
202012126164	JATAI	JT12219519	JATAI S1	22/12/2020 15:12	23/12/2020 05:24	22/12/2020 15:12	23/12/2020 05:24	14,18	1	14,18	CHI
202012126173	LUZIANIA	LZ12304995	VIANOPOLIS	22/12/2020 15:13	22/12/2020 22:25	22/12/2020 15:13	22/12/2020 22:25	7,19	8	57,48	CHI
202012126173	ORIZONA	LZ12304995	VIANOPOLIS	22/12/2020 15:13	22/12/2020 22:25	22/12/2020 15:13	22/12/2020 22:25	7,19	90	646,67	CHI
202012126276	IACIARA	IA12262079	IACIARA S1	22/12/2020 15:13	23/12/2020 12:08	22/12/2020 15:13	22/12/2020 19:28	4,26	21	89,37	CHI
202012126276	IACIARA	IA12262079	IACIARA S1	22/12/2020 15:13	23/12/2020 12:08	22/12/2020 19:30	22/12/2020 22:36	3,09	15	46,29	CHI
202012126276	IACIARA	IA12262079	IACIARA S1	22/12/2020 15:13	23/12/2020 12:08	22/12/2020 22:43	23/12/2020 00:13	1,51	3	4,52	CHI
202012126276	IACIARA	IA12232130LD	IACIARA S1	22/12/2020 15:13	23/12/2020 12:08	22/12/2020 22:43	23/12/2020 07:51	9,13	8	73,04	CHI
202012126276	IACIARA	IA12232131	IACIARA S1	22/12/2020 15:13	23/12/2020 12:08	22/12/2020 19:30	23/12/2020 08:38	13,13	6	78,77	CHI
202012126276	IACIARA	IA12218841	IACIARA S1	22/12/2020 15:13	23/12/2020 12:08	22/12/2020 22:43	23/12/2020 10:46	12,05	3	36,15	CHI
202012126276	IACIARA	IA12325566	IACIARA S1	22/12/2020 15:13	23/12/2020 12:08	22/12/2020 22:43	23/12/2020 12:08	13,43	1	13,43	CHI
202012128501	MINEIROS	MY12043894RE	PARQUE DAS EMAS	22/12/2020 15:14	22/12/2020 23:10	22/12/2020 15:14	22/12/2020 23:10	7,93	95	752,90	CHI
202012126186	PORTEIRAO	10014723130	RIO DOS BOIS	22/12/2020 15:16	23/12/2020 06:48	22/12/2020 15:16	23/12/2020 06:48	15,53	1	15,53	CHI
202012126197	JATAI	JT12303837	JATAI S1	22/12/2020 15:17	22/12/2020 22:17	22/12/2020 15:17	22/12/2020 22:17	6,99	26	181,62	CHI
202012126207	JUSSARA	JR21019322	JUSSARA	22/12/2020 15:19	22/12/2020 18:05	22/12/2020 15:19	22/12/2020 18:05	2,77	1	2,77	CHI
202012126657	SANTO ANTONIO DA BARRA	EU18260942TS	ACREUNA	22/12/2020 15:19	24/12/2020 14:30	22/12/2020 15:19	24/12/2020 14:30	47,18	1	47,18	CHI
202012126657	ACREUNA	EU18260942TS	ACREUNA	22/12/2020 15:19	24/12/2020 14:30	22/12/2020 15:19	24/12/2020 14:30	47,18	18	849,27	CHI
202012126218	TROMBAS	TB12337360	MINACU	22/12/2020 15:21	22/12/2020 23:09	22/12/2020 15:21	22/12/2020 23:09	7,80	4	31,19	CHI
202012126225	DAMIANOPOLIS	DA12196513	IACIARA S2	22/12/2020 15:21	22/12/2020 17:20	22/12/2020 15:21	22/12/2020 17:20	1,97	61	119,98	CHI
202012128489	SAO LUIZ DO NORTE	SZ12046339	ITAPACI	22/12/2020 15:22	23/12/2020 00:55	22/12/2020 15:22	23/12/2020 00:55	9,55	3	28,64	CHI
202012126248	CACHOEIRA ALTA	PC12000018	CACHOEIRA ALTA	22/12/2020 15:26	22/12/2020 21:13	22/12/2020 15:26	22/12/2020 21:13	5,78	8	46,26	CHI
202012126248	SAO SIMAO	PC12000018	CACHOEIRA ALTA	22/12/2020 15:26	22/12/2020 21:13	22/12/2020 15:26	22/12/2020 21:13	5,78	10	57,82	CHI
202012126248	PARANAIGUARA	PC12000018	CACHOEIRA ALTA	22/12/2020 15:26	22/12/2020 21:13	22/12/2020 15:26	22/12/2020 21:13	5,78	35	202,39	CHI
202012126867	DAMIANOPOLIS	MB12192159	IACIARA S2	22/12/2020 15:26	22/12/2020 17:52	22/12/2020 15:26	22/12/2020 17:52	2,42	15	36,36	CHI
202012126867	MAMBAL	MB12192159	IACIARA S2	22/12/2020 15:26	22/12/2020 17:52	22/12/2020 15:26	22/12/2020 17:52	2,42	31	75,14	CHI
202012126277	MARA ROSA	MQ12208525	MARA ROSA	22/12/2020 15:30	22/12/2020 16:47	22/12/2020 15:30	22/12/2020 16:47	1,28	1	1,28	CHI
202012129042	CEZARINA	CZ12277695	CEZARINA	22/12/2020 15:32	23/12/2020 16:02	22/12/2020 15:32	23/12/2020 16:02	24,50	150	3675,42	CHI
202012129042	INDIARA	CZ12277695	CEZARINA	22/12/2020 15:32	23/12/2020 16:02	22/12/2020 15:32	23/12/2020 16:02	24,50	16	392,04	CHI
202012129042	CEZARINA	CZ12277695	CEZARINA	22/12/2020 15:32	23/12/2020 16:02	23/12/2020 03:16	23/12/2020 16:02	12,76	16	204,14	CHI
202012126320	ALVORADA DO NORTE	AQ12204159	IACIARA S2	22/12/2020 15:35	22/12/2020 20:17	22/12/2020 15:35	22/12/2020 20:17	4,69	23	107,97	CHI
202012126583	SANTA HELENA DE GOIAS	SH12387441	SANTA HELENA S1	22/12/2020 15:35	22/12/2020 23:41	22/12/2020 15:35	22/12/2020 23:41	8,10	3	24,29	CHI
202012126304	PIRENOPOLIS	PV21171245	CORUMBA	22/12/2020 15:36	22/12/2020 22:35	22/12/2020 15:36	22/12/2020 22:35	6,97	2	13,94	CHI
202012126307	OUVIDOR	OU12337537	CATALAO S1	22/12/2020 15:37	22/12/2020 17:41	22/12/2020 15:37	22/12/2020 17:41	2,06	34	70,08	CHI
202012126313	SERRANOPOLIS	SX13347888	CHAPADAO DO CEU	22/12/2020 15:39	22/12/2020 22:58	22/12/2020 15:39	22/12/2020 22:58	7,32	1	7,32	CHI
202012126313	SERRANOPOLIS	SX13347888	CHAPADAO DO CEU	22/12/2020 15:39	22/12/2020 22:58	22/12/2020 19:25	22/12/2020 22:58	3,55	2	7,11	CHI
202012126317	MAMBAL	MB12243113	IACIARA S2	22/12/2020 15:39	22/12/2020 16:45	22/12/2020 15:39	22/12/2020 16:45	1,08	279	302,71	CHI
202012126322	NOVO BRASIL	NB12087607	JUSSARA	22/12/2020 15:40	22/12/2020 16:50	22/12/2020 15:40	22/12/2020 16:50	1,16	10	11,62	CHI
202012126325	MONTES CLAROS DE GOIAS	ME12050933	IPORA	22/12/2020 15:41	22/12/2020 23:01	22/12/2020 15:41	22/12/2020 23:01	7,33	7	51,32	CHI
202012126418	URUACU	UR12237468	URUACU	22/12/2020 15:41	23/12/2020 11:22	22/12/2020 15:41	23/12/2020 11:22	19,68	7	137,73	CHI
202012126335	PIRENOPOLIS	220039630	CORUMBA	22/12/2020 15:42	23/12/2020 00:59	22/12/2020 15:42	23/12/2020 00:59	9,29	1	9,29	CHI
202012126350	DOVERLANDIA	DV12144430	CAIAPONIA	22/12/2020 15:44	22/12/2020 17:51	22/12/2020 15:44	22/12/2020 17:51	2,11	2	4,22	CHI
202012126361	ITUMBIRA	IT11000081	ITUMBIRA VELHA S1	22/12/2020 15:46	22/12/2020 20:21	22/12/2020 15:46	22/12/2020 20:21	4,58	173	792,34	CHI

202012126363	SAO LUIS DE MONTES BELOS	500033444	SAO LUIZ DOS MONTES BELOS	22/12/2020 15:46	22/12/2020 17:24	22/12/2020 15:46	22/12/2020 17:24	1,63	1	1,63	CHI
202012126610	SANTO ANTONIO DA BARRA	BZ12301385	ACREUNA	22/12/2020 15:46	22/12/2020 17:40	22/12/2020 15:46	22/12/2020 17:40	1,89	9	17,04	CHI
202012126368	TRINDADE	10029882050	TRINDADE	22/12/2020 15:47	22/12/2020 18:01	22/12/2020 15:47	22/12/2020 18:01	2,24	1	2,24	CHI
202012126374	IPORA	1530010886	IPORA	22/12/2020 15:47	22/12/2020 21:34	22/12/2020 15:47	22/12/2020 21:34	5,77	1	5,77	CHI
202012126378	ANAPOLIS	20772350	ANAPOLIS UNIVERSITARIO S2	22/12/2020 15:47	22/12/2020 22:29	22/12/2020 15:47	22/12/2020 22:29	6,68	1	6,68	CHI
202012126393	LUZIANIA	LZ12333210	CRISTALINA S2	22/12/2020 15:49	24/12/2020 15:53	22/12/2020 15:49	23/12/2020 20:13	28,40	19	539,61	CHI
202012126393	LUZIANIA	LZ12333210	CRISTALINA S2	22/12/2020 15:49	24/12/2020 15:53	23/12/2020 20:15	24/12/2020 15:53	19,65	19	373,29	CHI
202012126399	QUIRINOPOLIS	QI12249191RE	QUIRINOPOLIS	22/12/2020 15:50	23/12/2020 18:24	22/12/2020 15:50	23/12/2020 09:35	17,75	5	88,74	CHI
202012126399	QUIRINOPOLIS	QI12249191RE	QUIRINOPOLIS	22/12/2020 15:50	23/12/2020 18:24	23/12/2020 12:08	23/12/2020 13:24	1,27	5	6,33	CHI
202012126399	QUIRINOPOLIS	QI12249191RE	QUIRINOPOLIS	22/12/2020 15:50	23/12/2020 18:24	23/12/2020 15:50	23/12/2020 18:24	26,56	36	956,29	CHI
202012126415	ITAPURANGA	GS12310531	GOIAS	22/12/2020 15:50	22/12/2020 22:15	22/12/2020 15:50	22/12/2020 22:15	6,41	2	12,81	CHI
202012126415	GUARAITA	GS12310531	GOIAS	22/12/2020 15:50	22/12/2020 22:15	22/12/2020 15:50	22/12/2020 22:15	6,41	2	12,81	CHI
202012126415	GOIAS	GS12310531	GOIAS	22/12/2020 15:50	22/12/2020 22:15	22/12/2020 15:50	22/12/2020 22:15	6,41	19	121,73	CHI
202012126689	SAO MIGUEL DO ARAGUAIA	SM12000050	SAO MIGUEL DO ARAGUAIA	22/12/2020 15:50	22/12/2020 20:16	22/12/2020 15:50	22/12/2020 20:16	4,43	29	128,36	CHI
202012126407	PONTALINA	PK21000004	PONTALINA	22/12/2020 15:51	22/12/2020 17:22	22/12/2020 15:51	22/12/2020 17:22	1,51	1	1,51	CHI
202012126656	PALESTINA DE GOIAS	CP12395430	PALESTINA	22/12/2020 15:52	23/12/2020 11:17	22/12/2020 15:52	23/12/2020 11:17	19,41	1	19,41	CHI
202012126656	CAIAPONIA	CP12395430	PALESTINA	22/12/2020 15:52	23/12/2020 11:17	22/12/2020 15:52	23/12/2020 11:17	19,41	4	77,63	CHI
202012127773	NOVA IGUAU DE GOIAS	NH12166555	SANTA TEREZINHA	22/12/2020 15:52	22/12/2020 21:36	22/12/2020 15:52	22/12/2020 21:36	5,72	2	11,45	CHI
202012127773	PILAR DE GOIAS	NH12166555	SANTA TEREZINHA	22/12/2020 15:52	22/12/2020 21:36	22/12/2020 15:52	22/12/2020 21:36	5,72	2	11,45	CHI
202012126426	BONOPOLIS	BX21168224	SAO MIGUEL DO ARAGUAIA	22/12/2020 15:54	22/12/2020 21:20	22/12/2020 15:54	22/12/2020 21:20	5,42	1	5,42	CHI
202012126446	QUIRINOPOLIS	QI32052485	QUIRINOPOLIS	22/12/2020 15:57	22/12/2020 19:11	22/12/2020 15:57	22/12/2020 19:11	3,22	7	22,56	CHI
202012126527	IACIARA	IA12180792	IACIARA S2	22/12/2020 16:00	22/12/2020 18:08	22/12/2020 16:00	22/12/2020 18:08	2,12	11	23,32	CHI
202012126481	PETROLINA DE GOIAS	10003955751	PETROLINA	22/12/2020 16:02	23/12/2020 15:36	22/12/2020 16:02	23/12/2020 15:36	23,56	1	23,56	CHI
202012128206	JARAGUA	JA12000239	JARAGUA	22/12/2020 16:02	24/12/2020 07:58	22/12/2020 16:02	24/12/2020 07:58	39,92	14	558,84	CHI
202012128863	MARA ROSA	MQ12338220	MARA ROSA	22/12/2020 16:02	22/12/2020 23:27	22/12/2020 16:02	22/12/2020 23:27	7,41	3	22,22	CHI
202012126490	CAIAPONIA	PY18040163TS	PALESTINA	22/12/2020 16:04	23/12/2020 08:05	22/12/2020 16:04	23/12/2020 08:05	16,02	45	720,75	CHI
202012126490	PALESTINA DE GOIAS	PY18040163TS	PALESTINA	22/12/2020 16:04	23/12/2020 08:05	22/12/2020 16:04	23/12/2020 08:05	16,02	102	1633,70	CHI
202012126496	CAVALCANTE	MA12280267	SAO DOMINGOS	22/12/2020 16:04	23/12/2020 00:18	22/12/2020 16:04	23/12/2020 00:18	8,22	174	1430,86	CHI
202012126496	MONTE ALEGRE DE GOIAS	MA12280267	SAO DOMINGOS	22/12/2020 16:04	23/12/2020 00:18	22/12/2020 16:04	23/12/2020 00:18	8,22	13	106,90	CHI
202012126497	AGUA FRIA DE GOIAS	TL12095889	SAO JOAO D ALIANCA	22/12/2020 16:04	22/12/2020 17:31	22/12/2020 16:04	22/12/2020 17:31	1,44	7	10,05	CHI
202012126578	CHAPADAO DO CEU	DJ12153959	CHAPADAO DO CEU	22/12/2020 16:07	23/12/2020 15:03	22/12/2020 16:07	23/12/2020 15:03	22,93	7	160,50	CHI
202012128159	SANTO ANTONIO DO DESCOBERTO	SN12290921	AGUAS LINDAS DE GOIAS S2	22/12/2020 16:07	22/12/2020 20:35	22/12/2020 16:07	22/12/2020 20:35	4,46	28	124,86	CHI
202012126515	CALDAS NOVAS	10007712039	SERRA DE CALDAS	22/12/2020 16:08	22/12/2020 23:20	22/12/2020 16:08	22/12/2020 23:20	7,21	0	0,00	CHI
202012126532	EDEALINA	ED12075198	PONTALINA	22/12/2020 16:12	22/12/2020 19:18	22/12/2020 16:12	22/12/2020 19:18	3,10	2	6,19	CHI
202012126536	FLORES DE GOIAS	FB12255034	FLORES DE GOIAS	22/12/2020 16:12	23/12/2020 16:43	23/12/2020 15:00	23/12/2020 16:43	1,70	16	27,24	CHI
202012127454	FAINA	FC12228930	GOIAS	22/12/2020 16:12	22/12/2020 21:06	22/12/2020 16:12	22/12/2020 21:06	4,89	13	63,63	CHI
202012126541	CRISTALINA	KR12037184	CRISTALINA S1	22/12/2020 16:14	22/12/2020 18:58	22/12/2020 16:14	22/12/2020 18:58	2,73	3	8,19	CHI
202012126879	SAO JOAO D ALIANCA	NQ12234731	NIQUELANDIA SUBTRANSMISSAO	22/12/2020 16:14	23/12/2020 23:40	22/12/2020 16:14	23/12/2020 23:40	31,43	1	31,43	CHI
202012126879	NIQUELANDIA	NQ12234731	NIQUELANDIA SUBTRANSMISSAO	22/12/2020 16:14	23/12/2020 23:40	22/12/2020 16:14	23/12/2020 23:40	31,43	13	408,58	CHI
202012126879	ALTO PARAISO DE GOIAS	NQ12234731	NIQUELANDIA SUBTRANSMISSAO	22/12/2020 16:14	23/12/2020 23:40	22/12/2020 16:14	23/12/2020 23:40	31,43	12	377,15	CHI
202012127846	NIQUELANDIA	NQ12254469	URUACU	22/12/2020 16:14	23/12/2020 10:36	22/12/2020 16:14	23/12/2020 10:36	18,36	9	165,22	CHI
202012127711	HEITORAI	HE12336326	ITAPURANGA	22/12/2020 16:15	23/12/2020 00:14	22/12/2020 16:15	23/12/2020 00:14	7,98	2	15,96	CHI
202012126898	RIO VERDE	630596256	CABRIUVA S1	22/12/2020 16:18	22/12/2020 18:39	22/12/2020 16:18	22/12/2020 18:39	2,34	1	2,34	CHI
202012126803	PIRANHAS	BM12212797	BOM JARDIM	22/12/2020 16:19	23/12/2020 10:33	22/12/2020 16:19	23/12/2020 10:33	18,23	2	36,46	CHI
202012126803	BOM JARDIM DE GOIAS	BM12212797	BOM JARDIM	22/12/2020 16:19	23/12/2020 10:33	22/12/2020 16:19	23/12/2020 10:33	18,23	86	1567,71	CHI
202012126605	ALEXANIA	AX12095958	CORUMBA	22/12/2020 16:20	23/12/2020 17:40	22/12/2020 16:20	23/12/2020 17:40	25,33	7	177,32	CHI
202012126605	CORUMBA DE GOIAS	AX12095958	CORUMBA	22/12/2020 16:20	23/12/2020 17:40	22/12/2020 16:20	23/12/2020 17:40	25,33	3	75,99	CHI
202012126581	CAMPOS VERDES	VD12201662	SANTA TEREZINHA	22/12/2020 16:21	22/12/2020 19:53	22/12/2020 16:21	22/12/2020 19:53	3,52	5	17,60	CHI
202012126582	CACU	CC21125814	CACHOEIRA ALTA	22/12/2020 16:21	22/12/2020 19:45	22/12/2020 16:21	22/12/2020 19:45	3,39	1	3,39	CHI
202012127517	OURO VERDE DE GOIAS	PG12255953	PETROLINA	22/12/2020 16:21	22/12/2020 20:29	22/12/2020 16:21	22/12/2020 20:29	4,12	23	94,72	CHI
202012127517	PETROLINA DE GOIAS	PG12255953	PETROLINA	22/12/2020 16:21	22/12/2020 20:29	22/12/2020 16:21	22/12/2020 20:29	4,12	116	477,73	CHI

202012127517	DAMOLANDIA	PG12255953	PETROLINA	22/12/2020 16:21	22/12/2020 20:29	22/12/2020 16:21	22/12/2020 20:29	4,12	1	4,12	CHI
202012127026	ITAPURANGA	IC12036344	ITAPURANGA	22/12/2020 16:22	22/12/2020 23:11	22/12/2020 16:22	22/12/2020 23:11	6,80	75	510,15	CHI
202012127026	HEITORAI	IC12036344	ITAPURANGA	22/12/2020 16:22	22/12/2020 23:11	22/12/2020 16:22	22/12/2020 23:11	6,80	4	27,21	CHI
202012127026	ITAGUARU	IC12036344	ITAPURANGA	22/12/2020 16:22	22/12/2020 23:11	22/12/2020 16:22	22/12/2020 23:11	6,80	3	20,41	CHI
202012127249	CORUMBAIBA	CI12000463RE	VILA CORUMBA	22/12/2020 16:22	22/12/2020 19:41	22/12/2020 16:22	22/12/2020 19:41	3,31	135	446,32	CHI
202012126685	GUAPO	GA12000172	GUAPO S1	22/12/2020 16:24	22/12/2020 18:36	22/12/2020 16:24	22/12/2020 18:36	2,19	4	8,77	CHI
202012127178	TRINDADE	TR12054884	GOYA S2	22/12/2020 16:24	22/12/2020 20:41	22/12/2020 16:24	22/12/2020 20:41	4,28	71	304,04	CHI
202012127311	CAMPOS VERDES	VD12332081	SANTA TEREZINHA	22/12/2020 16:24	22/12/2020 20:54	22/12/2020 16:24	22/12/2020 20:54	4,48	2	8,97	CHI
202012126623	ARAGUAPAZ	AZ11157578	MOZARLANDIA	22/12/2020 16:26	22/12/2020 17:37	22/12/2020 16:26	22/12/2020 17:37	1,18	129	151,97	CHI
202012126807	JARAGUA	JA12112518	JARAGUA	22/12/2020 16:26	23/12/2020 18:27	22/12/2020 16:26	23/12/2020 18:27	26,00	16	416,04	CHI
202012126632	BURITI ALEGRE	BG12209179	ITUMBIARA VELHA S2	22/12/2020 16:27	22/12/2020 23:10	22/12/2020 16:27	22/12/2020 23:10	6,71	67	449,85	CHI
202012126751	SERRANOPOLIS	SX12166009	JATAI S1	22/12/2020 16:27	22/12/2020 21:21	22/12/2020 16:27	22/12/2020 21:21	4,89	9	43,98	CHI
202012127756	HEITORAI	HE12158782	ITAPURANGA	22/12/2020 16:28	23/12/2020 12:09	22/12/2020 16:28	23/12/2020 12:09	19,67	4	78,68	CHI
202012127756	ITAPURANGA	HE12158782	ITAPURANGA	22/12/2020 16:28	23/12/2020 12:09	22/12/2020 16:28	23/12/2020 12:09	19,67	16	314,71	CHI
202012126661	SERRANOPOLIS	SX21123305	ITAJA S1	22/12/2020 16:29	23/12/2020 14:36	22/12/2020 16:29	23/12/2020 14:36	22,11	1	22,11	CHI
202012126662	NOVO GAMA	NJ12389552	PACAEMBU S2	22/12/2020 16:30	23/12/2020 12:39	22/12/2020 16:30	23/12/2020 12:39	20,15	2	40,30	CHI
202012127030	MINACU	IH12088797	MINACU	22/12/2020 16:32	22/12/2020 20:09	22/12/2020 16:32	22/12/2020 20:09	3,61	143	516,55	CHI
202012126690	PLANALTINA	PI12394160	SAO JOAO D ALIANCA	22/12/2020 16:34	22/12/2020 19:59	22/12/2020 16:34	22/12/2020 19:59	3,41	7	23,90	CHI
202012126702	NOVO BRASIL	NB21020214	JUSSARA	22/12/2020 16:34	23/12/2020 15:50	22/12/2020 16:34	23/12/2020 15:50	23,26	1	23,26	CHI
202012126757	GOIANDIRA	GD21203089	CATALAO S1	22/12/2020 16:34	22/12/2020 18:14	22/12/2020 16:34	22/12/2020 18:14	1,65	3	4,96	CHI
202012127389	GAMELEIRA DE GOIAS	GL12216197	ANAPOLIS UNIVERSITARIO S2	22/12/2020 16:34	22/12/2020 22:24	22/12/2020 16:34	22/12/2020 22:24	5,83	7	40,83	CHI
2020122200060	URUTAI	URT-TR1	URUTAI	22/12/2020 16:34	22/12/2020 16:51	22/12/2020 16:44	22/12/2020 16:47	0,06	1	0,06	CHI
2020122200060	CAMPO ALEGRE DE GOIAS	CPG-TR1	PIRES DO RIO S2	22/12/2020 16:34	22/12/2020 16:51	22/12/2020 16:44	22/12/2020 16:47	0,06	18	1,14	CHI
2020122200060	CATALAO	CPG-TR1	CAMPO ALEGRE DE GOIAS	22/12/2020 16:34	22/12/2020 16:51	22/12/2020 16:44	22/12/2020 16:47	0,06	59	3,74	CHI
2020122200060	IPAMERI	CPG-TR1	CAMPO ALEGRE DE GOIAS	22/12/2020 16:34	22/12/2020 16:51	22/12/2020 16:44	22/12/2020 16:47	0,06	16	1,01	CHI
2020122200060	IPAMERI	CPG-TR1	PIRES DO RIO S2	22/12/2020 16:34	22/12/2020 16:51	22/12/2020 16:44	22/12/2020 16:47	0,06	198	12,54	CHI
2020122200060	CATALAO	CPG-TR1	CAMPO ALEGRE DE GOIAS	22/12/2020 16:34	22/12/2020 16:51	22/12/2020 16:44	22/12/2020 16:47	0,06	21	1,33	CHI
2020122200060	CAMPO ALEGRE DE GOIAS	CPG-TR1	CAMPO ALEGRE DE GOIAS	22/12/2020 16:34	22/12/2020 16:51	22/12/2020 16:44	22/12/2020 16:47	0,06	233	14,76	CHI
2020122200060	IPAMERI	CPG-TR1	CAMPO ALEGRE DE GOIAS	22/12/2020 16:34	22/12/2020 16:51	22/12/2020 16:44	22/12/2020 16:47	0,06	112	7,09	CHI
2020122200060	CAMPO ALEGRE DE GOIAS	CPG-TR1	CAMPO ALEGRE DE GOIAS	22/12/2020 16:34	22/12/2020 16:51	22/12/2020 16:44	22/12/2020 16:47	0,06	2617	165,74	CHI
2020122200060	CAMPO ALEGRE DE GOIAS	CPG-TR1	CAMPO ALEGRE DE GOIAS	22/12/2020 16:34	22/12/2020 16:51	22/12/2020 16:44	22/12/2020 16:47	0,06	377	23,88	CHI
2020122200060	CATALAO	CPG-TR1	CAMPO ALEGRE DE GOIAS	22/12/2020 16:34	22/12/2020 16:51	22/12/2020 16:44	22/12/2020 16:47	0,06	16	1,01	CHI
2020122200060	DISTRITO FEDERAL	CPG-TR1	CAMPO ALEGRE DE GOIAS	22/12/2020 16:34	22/12/2020 16:51	22/12/2020 16:44	22/12/2020 16:47	0,06	1	0,06	CHI
2020122200060	NOVA AURORA	CAT-TR1	CATALAO S1	22/12/2020 16:34	22/12/2020 16:51	22/12/2020 16:44	22/12/2020 16:48	0,07	14	0,98	CHI
2020122200060	GOIANDIRA	CAT-TR1	CATALAO S1	22/12/2020 16:34	22/12/2020 16:51	22/12/2020 16:44	22/12/2020 16:48	0,07	2055	143,28	CHI
2020122200060	GOIANDIRA	CAT-TR1	CATALAO S1	22/12/2020 16:34	22/12/2020 16:51	22/12/2020 16:44	22/12/2020 16:48	0,07	74	5,16	CHI
2020122200060	OUVIDOR	CAT-TR1	CATALAO S1	22/12/2020 16:34	22/12/2020 16:51	22/12/2020 16:44	22/12/2020 16:48	0,07	2	0,14	CHI
2020122200060	GOIANDIRA	CAT-TR1	CATALAO S1	22/12/2020 16:34	22/12/2020 16:51	22/12/2020 16:44	22/12/2020 16:48	0,07	492	34,30	CHI
2020122200060	NOVA AURORA	CAT-TR1	CATALAO S1	22/12/2020 16:34	22/12/2020 16:51	22/12/2020 16:44	22/12/2020 16:48	0,07	3	0,21	CHI
2020122200060	CATALAO	CAT-TR1	CATALAO S1	22/12/2020 16:34	22/12/2020 16:51	22/12/2020 16:44	22/12/2020 16:48	0,07	579	40,37	CHI
2020122200060	TRES RANCHOS	CAT-TR1	CATALAO S1	22/12/2020 16:34	22/12/2020 16:51	22/12/2020 16:44	22/12/2020 16:48	0,07	5	0,35	CHI
2020122200060	CUMARI	CAT-TR1	CATALAO S1	22/12/2020 16:34	22/12/2020 16:51	22/12/2020 16:44	22/12/2020 16:48	0,07	312	21,75	CHI
2020122200060	CORUMBAIBA	CAT-TR1	CATALAO S1	22/12/2020 16:34	22/12/2020 16:51	22/12/2020 16:44	22/12/2020 16:48	0,07	135	9,41	CHI
2020122200060	CATALAO	CAT-TR1	CATALAO S1	22/12/2020 16:34	22/12/2020 16:51	22/12/2020 16:44	22/12/2020 16:48	0,07	555	38,70	CHI
2020122200060	MORRINHOS	CAT-TR1	CATALAO S1	22/12/2020 16:34	22/12/2020 16:51	22/12/2020 16:44	22/12/2020 16:48	0,07	1	0,07	CHI
2020122200060	DAVINOPOLIS	CAT-TR1	CATALAO S1	22/12/2020 16:34	22/12/2020 16:51	22/12/2020 16:44	22/12/2020 16:48	0,07	672	46,85	CHI
2020122200060	DAVINOPOLIS	CAT-TR1	CATALAO S1	22/12/2020 16:34	22/12/2020 16:51	22/12/2020 16:44	22/12/2020 16:48	0,07	11	0,77	CHI
2020122200060	CORUMBAIBA	CAT-TR1	CATALAO S1	22/12/2020 16:34	22/12/2020 16:51	22/12/2020 16:44	22/12/2020 16:48	0,07	2	0,14	CHI
2020122200060	ANHANGUERA	CAT-TR1	CATALAO S1	22/12/2020 16:34	22/12/2020 16:51	22/12/2020 16:44	22/12/2020 16:48	0,07	585	40,79	CHI
2020122200060	OUVIDOR	CAT-TR1	CATALAO S1	22/12/2020 16:34	22/12/2020 16:51	22/12/2020 16:44	22/12/2020 16:48	0,07	445	31,03	CHI
2020122200060	OUVIDOR	CAT-TR1	CATALAO S1	22/12/2020 16:34	22/12/2020 16:51	22/12/2020 16:44	22/12/2020 16:48	0,07	246	17,15	CHI

2020122200060	GOIANDIRA	CAT-TR1	CATALAO S1	22/12/2020 16:34	22/12/2020 16:51	22/12/2020 16:44	22/12/2020 16:48	0,07	13	0,91	CHI
2020122200060	CATALAO	CAT-TR1	CATALAO S1	22/12/2020 16:34	22/12/2020 16:51	22/12/2020 16:44	22/12/2020 16:48	0,07	31	2,16	CHI
2020122200060	OUVIDOR	CAT-TR1	CATALAO S1	22/12/2020 16:34	22/12/2020 16:51	22/12/2020 16:44	22/12/2020 16:48	0,07	31	2,16	CHI
2020122200060	GOIANDIRA	CAT-TR1	CATALAO S1	22/12/2020 16:34	22/12/2020 16:51	22/12/2020 16:44	22/12/2020 16:48	0,07	30	2,09	CHI
2020122200060	IPAMERI	CAT-TR1	CATALAO S1	22/12/2020 16:34	22/12/2020 16:51	22/12/2020 16:44	22/12/2020 16:48	0,07	15	1,05	CHI
2020122200060	GOIANDIRA	CAT-TR1	CATALAO S1	22/12/2020 16:34	22/12/2020 16:51	22/12/2020 16:44	22/12/2020 16:48	0,07	37	2,58	CHI
2020122200060	CAMPO ALEGRE DE GOIAS	CAT-TR1	CATALAO S1	22/12/2020 16:34	22/12/2020 16:51	22/12/2020 16:44	22/12/2020 16:48	0,07	3	0,21	CHI
2020122200060	CAMPO ALEGRE DE GOIAS	CAT-TR1	CATALAO S1	22/12/2020 16:34	22/12/2020 16:51	22/12/2020 16:44	22/12/2020 16:48	0,07	1	0,07	CHI
2020122200060	TRES RANCHOS	CAT-TR1	CATALAO S1	22/12/2020 16:34	22/12/2020 16:51	22/12/2020 16:44	22/12/2020 16:48	0,07	17	1,19	CHI
2020122200060	CATALAO	CAT-TR1	CATALAO S1	22/12/2020 16:34	22/12/2020 16:51	22/12/2020 16:44	22/12/2020 16:48	0,07	56	3,90	CHI
2020122200060	NOVA AURORA	CAT-TR1	CATALAO S1	22/12/2020 16:34	22/12/2020 16:51	22/12/2020 16:44	22/12/2020 16:48	0,07	1117	77,88	CHI
2020122200060	DISTRITO FEDERAL	CAT-TR1	CATALAO S1	22/12/2020 16:34	22/12/2020 16:51	22/12/2020 16:44	22/12/2020 16:48	0,07	12	0,84	CHI
2020122200060	DAVINOPOLIS	CAT-TR1	CATALAO S1	22/12/2020 16:34	22/12/2020 16:51	22/12/2020 16:44	22/12/2020 16:48	0,07	339	23,64	CHI
2020122200060	CUMARI	CAT-TR1	CATALAO S1	22/12/2020 16:34	22/12/2020 16:51	22/12/2020 16:44	22/12/2020 16:48	0,07	1217	84,85	CHI
2020122200060	CATALAO	CAT-TR1	CATALAO S1	22/12/2020 16:34	22/12/2020 16:51	22/12/2020 16:44	22/12/2020 16:48	0,07	239	16,66	CHI
2020122200060	NOVA AURORA	CAT-TR1	CATALAO S1	22/12/2020 16:34	22/12/2020 16:51	22/12/2020 16:44	22/12/2020 16:48	0,07	1	0,07	CHI
2020122200060	CATALAO	CAT-TR1	CATALAO S1	22/12/2020 16:34	22/12/2020 16:51	22/12/2020 16:44	22/12/2020 16:48	0,07	2468	172,07	CHI
2020122200060	CATALAO	CAT-TR1	CATALAO S1	22/12/2020 16:34	22/12/2020 16:51	22/12/2020 16:44	22/12/2020 16:48	0,07	42	2,93	CHI
2020122200060	IPAMERI	CAT-TR1	CATALAO S1	22/12/2020 16:34	22/12/2020 16:51	22/12/2020 16:44	22/12/2020 16:48	0,07	7	0,49	CHI
2020122200060	OUVIDOR	CAT-TR1	CATALAO S1	22/12/2020 16:34	22/12/2020 16:51	22/12/2020 16:44	22/12/2020 16:48	0,07	176	12,27	CHI
2020122200060	CATALAO	CAT-TR1	CATALAO S1	22/12/2020 16:34	22/12/2020 16:51	22/12/2020 16:44	22/12/2020 16:48	0,07	86	6,00	CHI
2020122200060	CUMARI	CAT-TR1	CATALAO S1	22/12/2020 16:34	22/12/2020 16:51	22/12/2020 16:44	22/12/2020 16:48	0,07	5	0,35	CHI
2020122200060	CATALAO	CAT-TR5	CATALAO S2	22/12/2020 16:34	22/12/2020 16:51	22/12/2020 16:44	22/12/2020 16:49	0,10	7219	713,88	CHI
2020122200060	CATALAO	CAT-TR5	CATALAO S2	22/12/2020 16:34	22/12/2020 16:51	22/12/2020 16:44	22/12/2020 16:49	0,10	9017	891,68	CHI
2020122200060	CUMARI	CAT-TR5	CATALAO S2	22/12/2020 16:34	22/12/2020 16:51	22/12/2020 16:44	22/12/2020 16:49	0,10	52	5,14	CHI
2020122200060	CATALAO	CAT-TR5	CATALAO S2	22/12/2020 16:34	22/12/2020 16:51	22/12/2020 16:44	22/12/2020 16:49	0,10	8086	799,62	CHI
2020122200060	CUMARI	CAT-TR5	CATALAO S2	22/12/2020 16:34	22/12/2020 16:51	22/12/2020 16:44	22/12/2020 16:49	0,10	18	1,78	CHI
2020122200060	CATALAO	CAT-TR5	CATALAO S2	22/12/2020 16:34	22/12/2020 16:51	22/12/2020 16:44	22/12/2020 16:49	0,10	7471	738,80	CHI
2020122200060	CATALAO	CAT-TR5	CATALAO S2	22/12/2020 16:34	22/12/2020 16:51	22/12/2020 16:44	22/12/2020 16:51	0,13	10564	1326,37	CHI
202012127243	ITAPURANGA	IK12071747	ITAPURANGA	22/12/2020 16:36	22/12/2020 20:39	22/12/2020 16:36	22/12/2020 20:39	4,05	55	222,58	CHI
202012126966	ALTO PARAISO DE GOIAS	TI12312377	NIQUELANDIA SUBTRANSMISSAO	22/12/2020 16:37	23/12/2020 07:40	22/12/2020 16:37	23/12/2020 07:40	15,03	9	135,31	CHI
202012126966	COLINAS DO SUL	TI12312377	NIQUELANDIA SUBTRANSMISSAO	22/12/2020 16:37	23/12/2020 07:40	22/12/2020 16:37	23/12/2020 07:40	15,03	6	90,21	CHI
202012126977	CORUMBAIBA	CI12149233	VILA CORUMBA	22/12/2020 16:39	23/12/2020 00:32	22/12/2020 16:39	23/12/2020 00:32	7,88	8	63,01	CHI
202012126738	QUIRINOPOLIS	QI12000060	QUIRINOPOLIS	22/12/2020 16:41	22/12/2020 19:31	22/12/2020 16:41	22/12/2020 19:31	2,83	7	19,78	CHI
2020122200060	IPAMERI	00830504	IPAMERI	22/12/2020 16:41	22/12/2020 16:51	22/12/2020 16:41	22/12/2020 16:44	0,05	3	0,15	CHI
2020122200060	IPAMERI	00830504	IPAMERI	22/12/2020 16:41	22/12/2020 16:51	22/12/2020 16:41	22/12/2020 16:44	0,05	3	0,15	CHI
2020122200060	IPAMERI	00830504	IPAMERI	22/12/2020 16:41	22/12/2020 16:51	22/12/2020 16:41	22/12/2020 16:47	0,11	254	29,00	CHI
2020122200060	IPAMERI	04601	IPAMERI	22/12/2020 16:41	22/12/2020 16:51	22/12/2020 16:41	22/12/2020 16:47	0,11	48	5,48	CHI
2020122200060	NOVA AURORA	00830504	IPAMERI	22/12/2020 16:41	22/12/2020 16:51	22/12/2020 16:41	22/12/2020 16:47	0,11	2	0,23	CHI
2020122200060	CORUMBAIBA	00830504	IPAMERI	22/12/2020 16:41	22/12/2020 16:51	22/12/2020 16:41	22/12/2020 16:47	0,11	16	1,83	CHI
2020122200060	GOIANDIRA	00830504	IPAMERI	22/12/2020 16:41	22/12/2020 16:51	22/12/2020 16:41	22/12/2020 16:47	0,11	15	1,71	CHI
2020122200060	CATALAO	00830504	IPAMERI	22/12/2020 16:41	22/12/2020 16:51	22/12/2020 16:41	22/12/2020 16:47	0,11	7	0,80	CHI
2020122200060	IPAMERI	03790508	URUTAI	22/12/2020 16:41	22/12/2020 16:51	22/12/2020 16:41	22/12/2020 16:47	0,11	145	16,55	CHI
2020122200060	CATALAO	04601	IPAMERI	22/12/2020 16:41	22/12/2020 16:51	22/12/2020 16:41	22/12/2020 16:47	0,11	22	2,51	CHI
2020122200060	PIRES DO RIO	03790508	URUTAI	22/12/2020 16:41	22/12/2020 16:51	22/12/2020 16:41	22/12/2020 16:47	0,11	10	1,14	CHI
2020122200060	URUTAI	00830504	IPAMERI	22/12/2020 16:41	22/12/2020 16:51	22/12/2020 16:41	22/12/2020 16:47	0,11	4	0,46	CHI
2020122200060	IPAMERI	00830504	IPAMERI	22/12/2020 16:41	22/12/2020 16:51	22/12/2020 16:41	22/12/2020 16:47	0,11	9942	1135,04	CHI
2020122200060	CALDAS NOVAS	00830504	IPAMERI	22/12/2020 16:41	22/12/2020 16:51	22/12/2020 16:41	22/12/2020 16:47	0,11	11	1,26	CHI
2020122200060	URUTAI	03790508	URUTAI	22/12/2020 16:41	22/12/2020 16:51	22/12/2020 16:41	22/12/2020 16:47	0,11	1872	213,72	CHI
202012127009	OURO VERDE DE GOIAS	OV12312024	NEROPOLIS S1	22/12/2020 16:43	23/12/2020 10:14	22/12/2020 16:43	23/12/2020 10:14	17,51	10	175,12	CHI
2020122200064	CATALAO	00340404	CATALAO S1	22/12/2020 16:44	22/12/2020 16:48	22/12/2020 16:44	22/12/2020 16:48	0,07	1	0,07	CHI

2020122200064	TRES RANCHOS	26401	CATALAO S1	22/12/2020 16:44	22/12/2020 16:48	22/12/2020 16:44	22/12/2020 16:48	0,07	2	0,13	CHI
2020122200064	GOIANDIRA	30802	CATALAO S1	22/12/2020 16:44	22/12/2020 16:48	22/12/2020 16:44	22/12/2020 16:48	0,07	2	0,13	CHI
2020122200064	CATALAO	26401	CATALAO S1	22/12/2020 16:44	22/12/2020 16:48	22/12/2020 16:44	22/12/2020 16:48	0,07	1	0,07	CHI
2020122200064	GOIANDIRA	30802	CATALAO S1	22/12/2020 16:44	22/12/2020 16:48	22/12/2020 16:44	22/12/2020 16:48	0,07	1	0,07	CHI
2020122200064	NOVA AURORA	30802	CATALAO S1	22/12/2020 16:44	22/12/2020 16:48	22/12/2020 16:44	22/12/2020 16:48	0,07	14	0,98	CHI
2020122200064	TRES RANCHOS	26301	CATALAO S1	22/12/2020 16:44	22/12/2020 16:48	22/12/2020 16:44	22/12/2020 16:48	0,07	24	1,68	CHI
2020122200064	CATALAO	00340404	CATALAO S1	22/12/2020 16:44	22/12/2020 16:48	22/12/2020 16:44	22/12/2020 16:48	0,07	1155	80,85	CHI
2020122200064	TRES RANCHOS	26401	CATALAO S1	22/12/2020 16:44	22/12/2020 16:48	22/12/2020 16:44	22/12/2020 16:48	0,07	27	1,89	CHI
2020122200064	GOIANDIRA	30802	CATALAO S1	22/12/2020 16:44	22/12/2020 16:48	22/12/2020 16:44	22/12/2020 16:48	0,07	6	0,42	CHI
2020122200064	OUVIDOR	26401	CATALAO S1	22/12/2020 16:44	22/12/2020 16:48	22/12/2020 16:44	22/12/2020 16:48	0,07	156	10,92	CHI
2020122200064	CAMPO ALEGRE DE GOIAS	00340404	CATALAO S1	22/12/2020 16:44	22/12/2020 16:48	22/12/2020 16:44	22/12/2020 16:48	0,07	1	0,07	CHI
2020122200064	OUVIDOR	26401	CATALAO S1	22/12/2020 16:44	22/12/2020 16:48	22/12/2020 16:44	22/12/2020 16:48	0,07	2	0,14	CHI
2020122200064	OUVIDOR	26301	CATALAO S1	22/12/2020 16:44	22/12/2020 16:48	22/12/2020 16:44	22/12/2020 16:48	0,07	3042	212,94	CHI
2020122200064	TRES RANCHOS	26401	CATALAO S1	22/12/2020 16:44	22/12/2020 16:48	22/12/2020 16:44	22/12/2020 16:48	0,07	1967	137,69	CHI
2020122200064	CATALAO	26301	CATALAO S1	22/12/2020 16:44	22/12/2020 16:48	22/12/2020 16:44	22/12/2020 16:48	0,07	5	0,35	CHI
2020122200064	DAVINOPOLIS	00340404	CATALAO S1	22/12/2020 16:44	22/12/2020 16:48	22/12/2020 16:44	22/12/2020 16:48	0,07	13	0,91	CHI
2020122200064	TRES RANCHOS	26401	CATALAO S1	22/12/2020 16:44	22/12/2020 16:48	22/12/2020 16:44	22/12/2020 16:48	0,07	267	18,69	CHI
2020122200064	GOIANDIRA	30802	CATALAO S1	22/12/2020 16:44	22/12/2020 16:48	22/12/2020 16:44	22/12/2020 16:48	0,07	69	4,83	CHI
202012126984	ANICUNS	AC12076714	ANICUNS	22/12/2020 16:45	22/12/2020 18:52	22/12/2020 16:45	22/12/2020 18:52	2,11	52	109,59	CHI
202012128177	SAO JOAO D ALIANCA	JL12218396	SAO JOAO D ALIANCA	22/12/2020 16:45	22/12/2020 22:32	22/12/2020 16:45	22/12/2020 22:32	5,77	7	40,42	CHI
202012126808	ALVORADA DO NORTE	AQ12184658	FLORES DE GOIAS	22/12/2020 16:48	23/12/2020 12:33	22/12/2020 16:48	23/12/2020 12:33	19,74	18	355,37	CHI
202012127101	TAQUARAL DE GOIAS	TQ12250778	INHUMAS S1	22/12/2020 16:48	22/12/2020 20:17	22/12/2020 16:48	22/12/2020 20:17	3,47	39	135,33	CHI
202012126895	SANTO ANTONIO DO DESCOBERTO	SN12048858	MARAJOARA	22/12/2020 16:55	23/12/2020 19:11	22/12/2020 16:55	23/12/2020 19:11	26,26	2	52,52	CHI
202012126902	QUIRINOPOLIS	QI12409402	QUIRINOPOLIS	22/12/2020 16:56	22/12/2020 23:36	22/12/2020 16:56	22/12/2020 23:36	6,66	2	13,32	CHI
202012126904	ANICUNS	AC12304603	FIRMINOPOLIS S2	22/12/2020 16:56	23/12/2020 08:47	22/12/2020 16:56	23/12/2020 08:47	15,84	3	47,53	CHI
202012127069	SAO MIGUEL DO ARAGUAIA	SM12321016	NOVA CRIXAS	22/12/2020 16:56	22/12/2020 21:14	22/12/2020 16:56	22/12/2020 21:14	4,29	7	30,06	CHI
202012126924	MARA ROSA	MQ12104649	MARA ROSA	22/12/2020 16:59	22/12/2020 19:50	22/12/2020 16:59	22/12/2020 19:50	2,84	3	8,51	CHI
202012126927	CAVALCANTE	CJ12208768RE	FLORES DE GOIAS	22/12/2020 16:59	22/12/2020 19:30	22/12/2020 16:59	22/12/2020 19:30	2,50	152	380,42	CHI
202012127234	SILVANIA	SV12058432	DAIA S2	22/12/2020 16:59	23/12/2020 00:21	22/12/2020 16:59	23/12/2020 00:21	7,35	10	73,53	CHI
202012126930	MIMOSO DE GOIAS	MJ12376716	PADRE BERNARDO	22/12/2020 17:00	22/12/2020 19:31	22/12/2020 17:00	22/12/2020 19:31	2,51	5	12,57	CHI
202012127105	RIO VERDE	BZ12212620	SANTA HELENA S1	22/12/2020 17:00	22/12/2020 21:45	22/12/2020 17:00	22/12/2020 21:45	4,75	4	19,00	CHI
202012127105	SANTO ANTONIO DA BARRA	BZ12212620	SANTA HELENA S1	22/12/2020 17:00	22/12/2020 21:45	22/12/2020 17:00	22/12/2020 21:45	4,75	11	52,25	CHI
202012127116	FORMOSA	FA12248883	ITUIQUIRA	22/12/2020 17:00	23/12/2020 10:34	22/12/2020 17:00	23/12/2020 10:34	17,56	17	298,54	CHI
202012126960	DOVERLANDIA	DV12188456	CAIAPONIA	22/12/2020 17:02	22/12/2020 23:39	22/12/2020 17:02	22/12/2020 23:39	6,61	2	13,21	CHI
202012126962	MORRINHOS	MR12119700RE	MORRINHOS	22/12/2020 17:02	22/12/2020 21:30	22/12/2020 17:02	22/12/2020 21:30	4,45	43	191,42	CHI
202012127162	SANTA RITA DO NOVO DESTINO	GE12006474	BARRO ALTO	22/12/2020 17:03	23/12/2020 15:58	22/12/2020 17:03	23/12/2020 15:58	22,91	6	137,49	CHI
202012127162	GOIANESIA	GE12006474	BARRO ALTO	22/12/2020 17:03	23/12/2020 15:58	22/12/2020 17:03	23/12/2020 15:58	22,91	2	45,83	CHI
202012127162	SAO LUIZ DO NORTE	GE12006474	BARRO ALTO	22/12/2020 17:03	23/12/2020 15:58	22/12/2020 17:03	23/12/2020 15:58	22,91	1	22,91	CHI
202012126991	BONOPOLIS	BX12203505	SAO MIGUEL DO ARAGUAIA	22/12/2020 17:05	23/12/2020 15:34	22/12/2020 17:05	23/12/2020 15:34	22,47	2	44,94	CHI
202012127237	SILVANIA	SV12389456	VIANOPOLIS	22/12/2020 17:05	22/12/2020 20:56	22/12/2020 17:05	22/12/2020 20:56	3,84	27	103,66	CHI
202012126999	LUZIANIA	LZ12249237	VIANOPOLIS	22/12/2020 17:06	22/12/2020 19:51	22/12/2020 17:06	22/12/2020 19:51	2,75	2	5,49	CHI
202012127583	QUIRINOPOLIS	QI12050368	QUIRINOPOLIS	22/12/2020 17:06	22/12/2020 20:27	22/12/2020 17:06	22/12/2020 20:27	3,35	100	334,58	CHI
202012127583	CASTELANDIA	QI12050368	QUIRINOPOLIS	22/12/2020 17:06	22/12/2020 20:27	22/12/2020 17:06	22/12/2020 20:27	3,35	1	3,35	CHI
202012127054	CORUMBAIBA	CI12107485	VILA CORUMBA	22/12/2020 17:09	22/12/2020 20:44	22/12/2020 17:09	22/12/2020 20:44	3,58	20	71,58	CHI
202012127048	ORIZONA	OZ12170304	PIRES DO RIO S2	22/12/2020 17:11	22/12/2020 21:11	22/12/2020 17:11	22/12/2020 21:11	3,99	2	7,99	CHI
202012127073	AGUA FRIA DE GOIAS	TL12375597	SAO JOAO D ALIANCA	22/12/2020 17:14	23/12/2020 07:32	22/12/2020 17:14	23/12/2020 07:32	14,29	1	14,29	CHI
202012127077	ANAPOLIS	20424127	JUNDIAI S1	22/12/2020 17:14	23/12/2020 01:56	22/12/2020 17:14	23/12/2020 01:56	8,70	1	8,70	CHI
202012127755	DOVERLANDIA	DV12023480	CAIAPONIA	22/12/2020 17:14	23/12/2020 01:43	22/12/2020 17:14	23/12/2020 01:43	8,48	2	16,97	CHI
202012127755	CAIAPONIA	DV12023480	CAIAPONIA	22/12/2020 17:14	23/12/2020 01:43	22/12/2020 17:14	23/12/2020 01:43	8,48	17	144,22	CHI
202012127755	PIRANHAS	DV12023480	CAIAPONIA	22/12/2020 17:14	23/12/2020 01:43	22/12/2020 17:14	23/12/2020 01:43	8,48	9	76,35	CHI
202012127085	TRINDADE	TR12001811	GOYA S1	22/12/2020 17:15	22/12/2020 19:36	22/12/2020 17:15	22/12/2020 19:36	2,33	10	23,34	CHI

202012127091	SANTO ANTONIO DA BARRA	BZ21384587	ACREUNA	22/12/2020 17:16	22/12/2020 23:06	22/12/2020 17:16	22/12/2020 23:06	5,83	1	5,83	CHI
202012127268	JATAI	JT18191724TS	JATAI S2	22/12/2020 17:16	22/12/2020 19:27	22/12/2020 17:16	22/12/2020 19:27	2,18	128	278,47	CHI
202012127173	HIDROLANDIA	HD12007560	PONTALINA	22/12/2020 17:17	23/12/2020 02:17	22/12/2020 17:17	23/12/2020 02:17	8,99	14	125,85	CHI
202012127110	VILA BOA	FA12153225	IACIARA S2	22/12/2020 17:18	23/12/2020 08:58	22/12/2020 17:18	23/12/2020 08:58	15,66	32	501,09	CHI
202012127256	MONTES CLAROS DE GOIAS	ME12244013	IPORA	22/12/2020 17:18	23/12/2020 02:14	22/12/2020 17:18	23/12/2020 02:14	8,93	9	80,37	CHI
202012127664	AGUA FRIA DE GOIAS	TL12067436	SAO JOAO D ALIANCA	22/12/2020 17:18	22/12/2020 21:23	22/12/2020 17:18	22/12/2020 21:23	4,07	14	57,02	CHI
202012127966	ACREUNA	EU12260952	ACREUNA	22/12/2020 17:18	22/12/2020 22:34	22/12/2020 17:18	22/12/2020 22:34	5,26	7	36,80	CHI
202012127145	JATAI	RV12222009	CABRIUVA S2	22/12/2020 17:19	22/12/2020 19:09	22/12/2020 17:19	22/12/2020 19:09	1,83	16	29,21	CHI
202012127145	RIO VERDE	RV12222009	CABRIUVA S2	22/12/2020 17:19	22/12/2020 19:09	22/12/2020 17:19	22/12/2020 19:09	1,83	21	38,34	CHI
202012127126	VALPARAISO DE GOIAS	VA12000139	MARAJOARA	22/12/2020 17:20	23/12/2020 00:36	22/12/2020 17:20	23/12/2020 00:36	7,26	3	21,78	CHI
202012127134	ORIZONA	VN12073848	VIANOPOLIS	22/12/2020 17:21	22/12/2020 20:15	22/12/2020 17:21	22/12/2020 20:15	2,89	3	8,67	CHI
202012127146	NAZARIO	O1280414	ANICUNS	22/12/2020 17:21	23/12/2020 07:15	22/12/2020 17:21	22/12/2020 19:28	2,13	5	10,63	CHI
202012127146	NAZARIO	O1280414	ANICUNS	22/12/2020 17:21	23/12/2020 07:15	22/12/2020 20:38	22/12/2020 20:56	0,30	5	1,50	CHI
202012127146	PALMEIRAS DE GOIAS	NZ13248913	PALMEIRAS	22/12/2020 17:21	23/12/2020 07:15	22/12/2020 17:21	23/12/2020 07:15	13,90	2	27,80	CHI
202012127146	NAZARIO	NZ13248913	PALMEIRAS	22/12/2020 17:21	23/12/2020 07:15	22/12/2020 17:21	23/12/2020 07:15	13,90	3	41,70	CHI
202012127218	GOIANIA	GN12200020	GOYA S2	22/12/2020 17:21	22/12/2020 18:46	22/12/2020 17:21	22/12/2020 18:46	1,40	501	701,82	CHI
202012127143	JANDAIA	JD12233370	PALMEIRAS	22/12/2020 17:22	22/12/2020 23:04	22/12/2020 17:22	22/12/2020 23:04	5,69	9	51,23	CHI
202012127165	GOIATUBA	8554452	GOIATUBA S2	22/12/2020 17:25	23/12/2020 13:56	22/12/2020 17:25	23/12/2020 13:56	20,50	2	41,00	CHI
202012127352	SANTO ANTONIO DE GOIAS	GR12048879	NEROPOLIS S1	22/12/2020 17:25	22/12/2020 23:42	22/12/2020 17:25	22/12/2020 23:42	6,28	17	106,75	CHI
202012127487	ANICUNS	AC12024032	ANICUNS	22/12/2020 17:25	22/12/2020 22:19	22/12/2020 17:25	22/12/2020 22:19	4,89	24	117,27	CHI
202012127487	TURVANIA	AC12024032	ANICUNS	22/12/2020 17:25	22/12/2020 22:19	22/12/2020 17:25	22/12/2020 22:19	4,89	4	19,54	CHI
202012127180	MARZAGAO	MG12391489	VILA CORUMBA	22/12/2020 17:27	22/12/2020 23:05	22/12/2020 17:27	22/12/2020 23:05	5,62	11	61,83	CHI
202012127180	CALDAS NOVAS	MG12391489	VILA CORUMBA	22/12/2020 17:27	22/12/2020 23:05	22/12/2020 17:27	22/12/2020 23:05	5,62	1	5,62	CHI
202012127184	FORMOSO	ET12168852	MARA ROSA	22/12/2020 17:28	22/12/2020 20:30	22/12/2020 17:28	22/12/2020 20:30	3,02	2	6,04	CHI
202012127184	ESTRELA DO NORTE	ET12168852	MARA ROSA	22/12/2020 17:28	22/12/2020 20:30	22/12/2020 17:28	22/12/2020 20:30	3,02	4	12,08	CHI
202012127222	BELA VISTA DE GOIAS	BV32041307	BELA VISTA S1	22/12/2020 17:30	22/12/2020 19:23	22/12/2020 17:30	22/12/2020 19:23	1,88	9	16,90	CHI
202012127555	ALEXANIA	AX12403337	ALEXANIA	22/12/2020 17:30	23/12/2020 21:37	22/12/2020 17:30	23/12/2020 21:37	28,11	6	168,66	CHI
202012127235	FORMOSA	FA12394157	ITUIQUIRA	22/12/2020 17:31	23/12/2020 12:15	22/12/2020 17:31	23/12/2020 12:15	18,72	4	74,87	CHI
202012127775	CRISTALINA	KR12133541LD	CRISTALINA S1	22/12/2020 17:32	23/12/2020 00:00	22/12/2020 17:32	23/12/2020 00:00	6,46	20	129,29	CHI
202012127241	PONTALINA	PK12000026	PONTALINA	22/12/2020 17:33	22/12/2020 19:40	22/12/2020 17:33	22/12/2020 19:40	2,11	35	73,91	CHI
202012127252	FLORES DE GOIAS	FB12211535	IACIARA S2	22/12/2020 17:34	23/12/2020 14:03	22/12/2020 17:34	23/12/2020 14:03	20,48	370	7578,42	CHI
202012127258	CRISTALINA	KR12230276	CRISTALINA S2	22/12/2020 17:34	22/12/2020 21:53	22/12/2020 17:34	22/12/2020 21:53	4,30	14	60,21	CHI
202012127265	LUZIANIA	LZ12112942	PAMPLONA	22/12/2020 17:36	22/12/2020 23:25	22/12/2020 17:36	22/12/2020 23:25	5,82	9	52,34	CHI
202012127269	CALDAS NOVAS	CN12392136	VILA CORUMBA	22/12/2020 17:36	23/12/2020 20:24	22/12/2020 17:36	23/12/2020 20:24	26,79	2	53,58	CHI
202012127280	SANCLERLANDIA	SL12145801	FIRMINOPOLIS S2	22/12/2020 17:38	22/12/2020 20:04	22/12/2020 17:38	22/12/2020 20:04	2,43	3	7,29	CHI
202012127293	PARAUNA	PU12388915	PARAUNA	22/12/2020 17:39	22/12/2020 23:45	22/12/2020 17:39	22/12/2020 23:45	6,10	2	12,19	CHI
202012127298	CRIXAS	CX12390502	SANTA TEREZINHA	22/12/2020 17:39	23/12/2020 09:38	22/12/2020 17:39	23/12/2020 09:38	15,97	1	15,97	CHI
202012127518	ABADIANIA	AA11328291	ANAPOLIS UNIVERSITARIO S1	22/12/2020 17:43	22/12/2020 22:14	22/12/2020 17:43	22/12/2020 22:14	4,52	27	122,08	CHI
202012123952	TRINDADE	TR12006367	GUAPO S1	22/12/2020 17:46	22/12/2020 19:32	22/12/2020 17:46	22/12/2020 19:32	1,76	5	8,79	CHI
202012123952	GUAPO	TR12006367	GUAPO S1	22/12/2020 17:46	22/12/2020 19:32	22/12/2020 17:46	22/12/2020 19:32	1,76	41	72,11	CHI
202012127562	LUZIANIA	LZ12304863	MARAJOARA	22/12/2020 17:46	22/12/2020 21:49	22/12/2020 17:46	22/12/2020 21:49	4,05	67	271,16	CHI
202012127791	VIANOPOLIS	SV12282738	VIANOPOLIS	22/12/2020 17:46	22/12/2020 22:19	22/12/2020 17:46	22/12/2020 22:19	4,54	2	9,07	CHI
202012127791	SILVANIA	SV12282738	VIANOPOLIS	22/12/2020 17:46	22/12/2020 22:19	22/12/2020 17:46	22/12/2020 22:19	4,54	14	63,51	CHI
202012127791	SAO MIGUEL DO PASSA QUATRO	SV12282738	VIANOPOLIS	22/12/2020 17:46	22/12/2020 22:19	22/12/2020 17:46	22/12/2020 22:19	4,54	34	154,24	CHI
202012127345	AGUAS LINDAS DE GOIAS	LA11087880	AGUAS LINDAS DE GOIAS S1	22/12/2020 17:47	22/12/2020 23:57	22/12/2020 17:47	22/12/2020 19:07	1,33	128	170,56	CHI
202012127345	AGUAS LINDAS DE GOIAS	LA11087880	AGUAS LINDAS DE GOIAS S1	22/12/2020 17:47	22/12/2020 23:57	22/12/2020 22:08	22/12/2020 23:57	1,82	128	232,50	CHI
202012127351	CIDADE OCIDENTAL	O2900214	MARAJOARA	22/12/2020 17:47	23/12/2020 14:32	22/12/2020 17:47	23/12/2020 14:32	20,75	27	560,24	CHI
202012127456	FAINA	FC12275448	GOIAS	22/12/2020 17:48	22/12/2020 19:28	22/12/2020 17:48	22/12/2020 19:28	1,65	8	13,22	CHI
202012127376	ACREUNA	EU12086184	ACREUNA	22/12/2020 17:51	23/12/2020 10:42	22/12/2020 17:51	23/12/2020 10:42	16,85	1	16,85	CHI
202012127509	VALPARAISO DE GOIAS	VA12199713	PACAEMBU S1	22/12/2020 17:53	22/12/2020 20:33	22/12/2020 17:53	22/12/2020 20:33	2,66	65	173,22	CHI
202012128212	JATAI	JT12211164	JATAI S2	22/12/2020 17:53	22/12/2020 21:34	22/12/2020 17:53	22/12/2020 21:34	3,67	10	36,67	CHI

202012127404	ALEXANIA	AX11393201	ALEXANIA	22/12/2020 17:54	23/12/2020 18:41	22/12/2020 17:54	23/12/2020 18:41	24,78	93	2304,44	CHI
202012127413	MOINEIROS	MY11349091	PARQUE DAS EMAS	22/12/2020 17:56	23/12/2020 18:51	22/12/2020 17:56	23/12/2020 18:51	24,91	1	24,91	CHI
202012128081	GOIANIA	GN12035915	GOYA S1	22/12/2020 17:57	22/12/2020 23:51	22/12/2020 17:57	22/12/2020 23:50	5,87	98	575,42	CHI
202012128081	GOIANIA	GN11322896	GOYA S1	22/12/2020 17:57	22/12/2020 23:51	22/12/2020 17:57	22/12/2020 23:51	5,89	29	170,72	CHI
202012127429	SAO MIGUEL DO PASSA QUATRO	SQ12104016	BELA VISTA S2	22/12/2020 17:58	22/12/2020 22:42	22/12/2020 17:58	22/12/2020 22:42	4,72	13	61,39	CHI
202012127429	SILVANIA	SQ12104016	BELA VISTA S2	22/12/2020 17:58	22/12/2020 22:42	22/12/2020 17:58	22/12/2020 22:42	4,72	1	4,72	CHI
202012127438	ANAPOLIS	20922991	ANAPOLIS UNIVERSITARIO S2	22/12/2020 18:00	23/12/2020 00:00	22/12/2020 18:00	23/12/2020 00:00	6,00	1	6,00	CHI
202012127444	MATRINCHA	FC12362368	MATRINCHA	22/12/2020 18:00	22/12/2020 22:35	22/12/2020 18:00	22/12/2020 22:35	4,57	2	9,14	CHI
202012127444	FAINA	FC12362368	MATRINCHA	22/12/2020 18:00	22/12/2020 22:35	22/12/2020 18:00	22/12/2020 22:35	4,57	9	41,12	CHI
202012127457	MINACU	IH12132432	MINACU	22/12/2020 18:02	23/12/2020 09:14	22/12/2020 18:02	23/12/2020 09:14	15,19	121	1838,49	CHI
202012127457	CAMPINACU	IH12132432	MINACU	22/12/2020 18:02	23/12/2020 09:14	22/12/2020 18:02	23/12/2020 09:14	15,19	22	334,27	CHI
202012127694	SAO MIGUEL DO ARAGUAIA	SM12099146RE	SAO MIGUEL DO ARAGUAIA	22/12/2020 18:02	23/12/2020 08:38	22/12/2020 18:02	23/12/2020 08:38	14,59	53	773,27	CHI
202012127694	NOVO PLANALTO	SM12099146RE	SAO MIGUEL DO ARAGUAIA	22/12/2020 18:02	23/12/2020 08:38	22/12/2020 18:02	23/12/2020 08:38	14,59	0	0,00	CHI
202012128274	TURVELANDIA	TD12301556LD	RIO DOS BOIS	22/12/2020 18:02	23/12/2020 02:32	22/12/2020 18:02	23/12/2020 02:32	8,50	1	8,50	CHI
202012127590	SENADOR CANEDO	GN12077158	GOIANIA LESTE S2	22/12/2020 18:04	22/12/2020 22:20	22/12/2020 18:04	22/12/2020 22:20	4,26	24	102,21	CHI
202012127590	GOIANIA	GN12077158	GOIANIA LESTE S2	22/12/2020 18:04	22/12/2020 22:20	22/12/2020 18:04	22/12/2020 22:20	4,26	57	242,76	CHI
202012128088	SANTA FE DE GOIAS	RN12250752	BRITANIA	22/12/2020 18:05	23/12/2020 09:54	22/12/2020 18:05	23/12/2020 09:54	15,81	43	679,95	CHI
202012128088	JUSSARA	RN12250752	BRITANIA	22/12/2020 18:05	23/12/2020 09:54	22/12/2020 18:05	23/12/2020 09:54	15,81	19	300,44	CHI
202012127499	CIDADE OCIDENTAL	DH21305306	MARAJOARA	22/12/2020 18:09	23/12/2020 10:22	22/12/2020 18:09	23/12/2020 10:22	16,21	1	16,21	CHI
202012127507	SANTA FE DE GOIAS	RN10396175	BRITANIA	22/12/2020 18:09	23/12/2020 16:37	22/12/2020 18:09	23/12/2020 15:01	20,88	5	104,38	CHI
202012127507	SANTA FE DE GOIAS	RN12159290LD	BRITANIA	22/12/2020 18:09	23/12/2020 16:37	22/12/2020 18:09	23/12/2020 15:05	20,95	8	167,57	CHI
202012127507	SANTA FE DE GOIAS	RN12118521LD	BRITANIA	22/12/2020 18:09	23/12/2020 16:37	22/12/2020 18:09	23/12/2020 15:36	21,46	10	214,55	CHI
202012127507	ITAPIRAPUA	RN12298934LD	BRITANIA	22/12/2020 18:09	23/12/2020 16:37	22/12/2020 18:09	23/12/2020 16:37	22,47	2	44,93	CHI
202012127507	SANTA FE DE GOIAS	RN12298934LD	BRITANIA	22/12/2020 18:09	23/12/2020 16:37	22/12/2020 18:09	23/12/2020 16:37	22,47	11	247,12	CHI
202012127504	POSSE	PS12152680	IACIARA S2	22/12/2020 18:10	22/12/2020 22:33	22/12/2020 18:10	22/12/2020 22:33	4,38	9	39,38	CHI
202012127646	ITUMBIARA	IT12263432	ITUMBIARA VELHA S2	22/12/2020 18:11	23/12/2020 11:24	22/12/2020 18:11	23/12/2020 11:24	17,21	96	1652,05	CHI
202012127841	PIRACANJUBA	PJ12000086	PIRACANJUBA	22/12/2020 18:12	22/12/2020 23:23	22/12/2020 18:12	22/12/2020 23:23	5,18	9	46,58	CHI
202012127523	CRISTALINA	KR12110413	CRISTALINA S2	22/12/2020 18:13	23/12/2020 11:31	22/12/2020 18:13	23/12/2020 11:31	17,30	6	103,79	CHI
202012128764	FLORES DE GOIAS	FB12243096	FLORES DE GOIAS	22/12/2020 18:13	23/12/2020 18:10	22/12/2020 18:13	23/12/2020 18:10	23,95	5	119,74	CHI
202012127528	PEROLANDIA	DP21308765	JATAI S1	22/12/2020 18:14	23/12/2020 08:45	22/12/2020 18:14	23/12/2020 08:45	14,51	2	29,02	CHI
202012127851	MONTES CLAROS DE GOIAS	ME12355657	IPORA	22/12/2020 18:14	23/12/2020 05:13	22/12/2020 18:14	23/12/2020 05:13	10,98	7	76,88	CHI
202012127532	PETROLINA DE GOIAS	320007790	PETROLINA	22/12/2020 18:15	23/12/2020 16:12	22/12/2020 18:15	23/12/2020 16:12	21,95	1	21,95	CHI
202012131867	GOIAS	GS12162480LD	GOIAS	22/12/2020 18:16	23/12/2020 14:09	22/12/2020 18:16	23/12/2020 14:09	19,88	43	854,79	CHI
202012127582	ALTO HORIZONTE	NH12396799	SANTA TEREZINHA	22/12/2020 18:17	22/12/2020 23:06	22/12/2020 18:17	22/12/2020 23:06	4,81	9	43,30	CHI
202012127557	ITAUCU	IB12078567	ITABERAI S1	22/12/2020 18:19	23/12/2020 01:02	22/12/2020 18:19	23/12/2020 01:02	6,71	1	6,71	CHI
202012127557	ITABERAI	IB12078567	ITABERAI S1	22/12/2020 18:19	23/12/2020 01:02	22/12/2020 18:19	23/12/2020 01:02	6,71	5	33,56	CHI
202012127561	AMORINOPOLIS	1240010695	IPORA	22/12/2020 18:19	23/12/2020 07:29	22/12/2020 18:19	23/12/2020 07:29	13,16	1	13,16	CHI
202012127705	ALEXANIA	AX12000057	ALEXANIA	22/12/2020 18:19	23/12/2020 12:09	22/12/2020 18:19	23/12/2020 12:09	17,82	10	178,18	CHI
202012127705	SANTO ANTONIO DO DESCOBERTO	AX12000057	ALEXANIA	22/12/2020 18:19	23/12/2020 12:09	22/12/2020 18:19	23/12/2020 12:09	17,82	1	17,82	CHI
202012129132	CRISTALINA	KR12290816	PAMPLONA	22/12/2020 18:19	23/12/2020 03:59	22/12/2020 18:19	23/12/2020 03:59	9,66	34	328,54	CHI
202012127579	ITABERAI	IB12066172	ITABERAI S1	22/12/2020 18:20	22/12/2020 19:30	22/12/2020 18:20	22/12/2020 19:30	1,16	11	12,77	CHI
202012127793	MINACU	IH12392288	MINACU	22/12/2020 18:21	23/12/2020 01:35	22/12/2020 18:21	23/12/2020 01:35	7,22	6	43,32	CHI
202012127585	CACU	CA12013274	CACHOEIRA ALTA	22/12/2020 18:23	22/12/2020 21:42	22/12/2020 18:23	22/12/2020 21:42	3,32	6	19,90	CHI
202012127866	ANICUNS	AC12299009	FIRMINOPOLIS S2	22/12/2020 18:23	23/12/2020 11:27	22/12/2020 18:23	23/12/2020 11:27	17,06	1	17,06	CHI
202012127866	ADELANDIA	AC12299009	FIRMINOPOLIS S2	22/12/2020 18:23	23/12/2020 11:27	22/12/2020 18:23	23/12/2020 11:27	17,06	12	204,74	CHI
202012127639	SANTO ANTONIO DO DESCOBERTO	SN21161195	ALEXANIA	22/12/2020 18:28	23/12/2020 10:21	22/12/2020 18:28	23/12/2020 10:21	15,88	1	15,88	CHI
202012127692	ITAJA	IJ12370112	CACHOEIRA ALTA	22/12/2020 18:33	23/12/2020 07:29	22/12/2020 18:33	23/12/2020 07:29	12,93	2	25,86	CHI
202012127699	POSSE	PS12255357	IACIARA S2	22/12/2020 18:34	22/12/2020 19:30	22/12/2020 18:34	22/12/2020 19:30	0,92	5	4,61	CHI
202012127738	MUTUNOPOLIS	MU12336210	MARA ROSA	22/12/2020 18:35	23/12/2020 19:12	22/12/2020 18:35	23/12/2020 19:12	24,60	4	98,41	CHI
202012127704	CRISTALINA	03940216	CRISTALINA S2	22/12/2020 18:36	23/12/2020 09:49	22/12/2020 18:36	23/12/2020 04:00	9,40	62	582,73	CHI
202012127704	CRISTALINA	03940216	CRISTALINA S2	22/12/2020 18:36	23/12/2020 09:49	22/12/2020 22:24	23/12/2020 04:00	5,59	13	72,61	CHI

202012127704	CRISTALINA	03940216	CRISTALINA S2	22/12/2020 18:36	23/12/2020 09:49	22/12/2020 18:36	23/12/2020 04:18	9,70	86	834,42	CHI
202012127704	CRISTALINA	KR16408333	CRISTALINA S2	22/12/2020 18:36	23/12/2020 09:49	22/12/2020 22:24	23/12/2020 04:18	5,89	1	5,89	CHI
202012127704	CRISTALINA	03940216	CRISTALINA S2	22/12/2020 18:36	23/12/2020 09:49	22/12/2020 18:36	23/12/2020 08:51	14,26	1	14,26	CHI
202012127704	CRISTALINA	03940216	CRISTALINA S2	22/12/2020 18:36	23/12/2020 09:49	22/12/2020 18:36	23/12/2020 09:11	14,58	93	1356,22	CHI
202012127704	CRISTALINA	03940216	CRISTALINA S2	22/12/2020 18:36	23/12/2020 09:49	22/12/2020 22:24	23/12/2020 09:11	10,77	3	32,31	CHI
202012127704	CRISTALINA	03940216	CRISTALINA S2	22/12/2020 18:36	23/12/2020 09:49	22/12/2020 18:36	23/12/2020 09:49	15,22	28	426,04	CHI
202012127714	ITABERAÍ	IB12075677	ARACU	22/12/2020 18:36	22/12/2020 20:57	22/12/2020 18:36	22/12/2020 20:57	2,34	18	42,17	CHI
202012128001	PALMEIRAS DE GOIAS	PL12000034	PALMEIRAS	22/12/2020 18:36	22/12/2020 21:08	22/12/2020 18:36	22/12/2020 21:08	2,52	3	7,56	CHI
202012127731	ANAPOLIS	10004942971	ANAPOLIS UNIVERSITARIO S2	22/12/2020 18:38	23/12/2020 05:33	22/12/2020 18:38	23/12/2020 05:33	10,92	1	10,92	CHI
202012127874	INHUMAS	IN12402836	INHUMAS S1	22/12/2020 18:38	23/12/2020 04:28	22/12/2020 18:38	23/12/2020 04:28	9,85	3	29,54	CHI
202012128981	PIRACANJUBA	PJ12326569	CRISTIANOPOLIS	22/12/2020 18:38	22/12/2020 23:46	22/12/2020 23:29	22/12/2020 23:46	0,28	30	8,42	CHI
202012127732	BALIZA	3990004503	BOM JARDIM	22/12/2020 18:39	23/12/2020 07:52	22/12/2020 18:39	23/12/2020 07:52	13,23	1	13,23	CHI
202012127783	PETROLINA DE GOIAS	PG12033256	PETROLINA	22/12/2020 18:39	23/12/2020 14:20	22/12/2020 18:39	23/12/2020 14:20	19,67	28	550,67	CHI
202012127765	SAO DOMINGOS	SD12389196	SAO DOMINGOS	22/12/2020 18:43	22/12/2020 22:55	22/12/2020 18:43	22/12/2020 22:55	4,20	6	25,20	CHI
202012127936	SAO MIGUEL DO ARAGUAIA	SM12013036	SAO MIGUEL DO ARAGUAIA	22/12/2020 18:43	23/12/2020 14:05	22/12/2020 18:43	23/12/2020 14:05	19,36	22	425,83	CHI
202012127777	DISTRITO FEDERAL	FA13146118	ITIQUEIRA	22/12/2020 18:44	23/12/2020 10:34	22/12/2020 18:44	23/12/2020 10:34	15,82	1	15,82	CHI
202012127777	FORMOSA	FA13146118	ITIQUEIRA	22/12/2020 18:44	23/12/2020 10:34	22/12/2020 18:44	23/12/2020 10:34	15,82	12	189,88	CHI
202012127912	VARJAO	GA12034398	GUAPO S2	22/12/2020 18:44	22/12/2020 23:40	22/12/2020 18:44	22/12/2020 23:40	4,93	4	19,70	CHI
202012127912	GUAPO	GA12034398	GUAPO S2	22/12/2020 18:44	22/12/2020 23:40	22/12/2020 18:44	22/12/2020 23:40	4,93	2	9,85	CHI
202012127964	RIO VERDE	RV12123367	RIO VERDE S1	22/12/2020 18:48	22/12/2020 20:37	22/12/2020 18:48	22/12/2020 20:37	1,82	45	81,86	CHI
202012127806	CACU	CC12080196	CACHOEIRA ALTA	22/12/2020 18:50	23/12/2020 01:38	22/12/2020 18:50	23/12/2020 01:38	6,80	5	34,00	CHI
202012127810	AGUAS LINDAS DE GOIAS	LA12112919	AGUAS LINDAS DE GOIAS S2	22/12/2020 18:50	22/12/2020 21:51	22/12/2020 18:50	22/12/2020 21:51	3,01	2	6,02	CHI
202012127839	BURITI ALEGRE	BG12263593	ITUMBIARA VELHA S2	22/12/2020 18:53	23/12/2020 09:39	22/12/2020 18:53	23/12/2020 09:39	14,76	4	59,04	CHI
202012127843	LUZIANIA	LZ12253445	VIANOPOLIS	22/12/2020 18:54	23/12/2020 09:51	22/12/2020 18:54	23/12/2020 09:51	14,95	7	104,65	CHI
202012127868	SAO MIGUEL DO ARAGUAIA	SM21208510	SAO MIGUEL DO ARAGUAIA	22/12/2020 18:57	23/12/2020 11:55	22/12/2020 18:57	23/12/2020 11:55	16,96	1	16,96	CHI
202012127870	SENADOR CANEDO	SW11210400	SENADOR CANEDO	22/12/2020 18:57	23/12/2020 04:32	22/12/2020 19:12	22/12/2020 19:32	0,33	131	42,65	CHI
202012127870	SENADOR CANEDO	SW16415167	SENADOR CANEDO	22/12/2020 18:57	23/12/2020 04:32	22/12/2020 19:13	22/12/2020 19:32	0,32	1946	614,07	CHI
202012127870	SENADOR CANEDO	SW13400470	SENADOR CANEDO	22/12/2020 18:57	23/12/2020 04:32	23/12/2020 00:29	23/12/2020 03:16	2,79	494	1377,99	CHI
202012127870	SENADOR CANEDO	SW12401634LD	SENADOR CANEDO	22/12/2020 18:57	23/12/2020 04:32	22/12/2020 19:13	23/12/2020 03:17	8,06	512	4126,44	CHI
202012127870	SENADOR CANEDO	SW11210397	SENADOR CANEDO	22/12/2020 18:57	23/12/2020 04:32	23/12/2020 03:59	23/12/2020 04:30	0,50	116	58,48	CHI
202012127870	SENADOR CANEDO	SW11210395	SENADOR CANEDO	22/12/2020 18:57	23/12/2020 04:32	23/12/2020 04:00	23/12/2020 04:32	0,53	74	39,34	CHI
202012128013	ITUMBIARA	IT12263732	CACHOEIRA DOURADA	22/12/2020 18:57	22/12/2020 22:08	22/12/2020 18:57	22/12/2020 22:08	3,17	4	12,68	CHI
202012128044	SANTO ANTONIO DO DESCOBERTO	SN12037174	MARAJOARA	22/12/2020 18:58	23/12/2020 02:12	22/12/2020 18:58	23/12/2020 02:12	7,23	7	50,61	CHI
202012127901	IPORA	IR12035041	IPORA	22/12/2020 19:00	23/12/2020 01:10	22/12/2020 19:00	23/12/2020 01:10	6,17	1	6,17	CHI
202012127918	PIRES DO RIO	PR21000081	PIRES DO RIO S1	22/12/2020 19:02	23/12/2020 00:18	22/12/2020 19:02	23/12/2020 00:18	5,27	1	5,27	CHI
202012128741	DOVERLANDIA	DV12395479	CAIAPONIA	22/12/2020 19:02	23/12/2020 16:11	22/12/2020 19:02	23/12/2020 16:11	21,14	6	126,86	CHI
202012127924	APARECIDA DE GOIANIA	AP12002027	REAL S1	22/12/2020 19:03	22/12/2020 23:24	22/12/2020 19:03	22/12/2020 23:24	4,34	1	4,34	CHI
202012127928	IPAMERI	IP12319009	URUTAI	22/12/2020 19:04	23/12/2020 08:56	22/12/2020 19:04	23/12/2020 08:56	13,85	10	138,54	CHI
202012127963	SILVANIA	SV12265337	VIANOPOLIS	22/12/2020 19:07	22/12/2020 23:00	22/12/2020 19:07	22/12/2020 23:00	3,87	10	38,70	CHI
202012128287	HIDROLANDIA	VJ12019862	GUAPO S2	22/12/2020 19:07	23/12/2020 01:23	22/12/2020 19:07	23/12/2020 01:23	6,25	1	6,25	CHI
202012128287	VARJAO	VJ12019862	GUAPO S2	22/12/2020 19:07	23/12/2020 01:23	22/12/2020 19:07	23/12/2020 01:23	6,25	6	37,51	CHI
202012128287	MAIRIPOTABA	VJ12019862	GUAPO S2	22/12/2020 19:07	23/12/2020 01:23	22/12/2020 19:07	23/12/2020 01:23	6,25	2	12,50	CHI
202012127990	GOIANDIRA	GD12131063	CATALAO S1	22/12/2020 19:13	22/12/2020 20:44	22/12/2020 19:13	22/12/2020 20:44	1,51	4	6,05	CHI
202012127991	CRISTIANOPOLIS	BC12300653	CRISTIANOPOLIS	22/12/2020 19:13	22/12/2020 20:19	22/12/2020 19:13	22/12/2020 20:19	1,09	13	14,23	CHI
202012127991	SANTA CRUZ DE GOIAS	BC12300653	CRISTIANOPOLIS	22/12/2020 19:13	22/12/2020 20:19	22/12/2020 19:13	22/12/2020 20:19	1,09	23	25,17	CHI
202012127995	ANICUNS	AC12020526	ANICUNS	22/12/2020 19:14	23/12/2020 10:17	22/12/2020 19:14	23/12/2020 10:17	15,05	9	135,42	CHI
2020122200034	RIO VERDE	MOT-TR1	MONTIVIDIU T	22/12/2020 19:14	23/12/2020 00:38	22/12/2020 19:15	22/12/2020 19:20	0,08	28	2,38	CHI
2020122200034	RIO VERDE	RV10401437	MONTIVIDIU T	22/12/2020 19:14	23/12/2020 00:38	22/12/2020 19:15	22/12/2020 19:20	0,08	104	8,84	CHI
2020122200034	RIO VERDE	MOT-TR1	MONTIVIDIU T	22/12/2020 19:14	23/12/2020 00:38	22/12/2020 19:15	22/12/2020 19:20	0,08	96	8,16	CHI
2020122200034	MONTIVIDIU	RV10401437	MONTIVIDIU T	22/12/2020 19:14	23/12/2020 00:38	22/12/2020 19:15	22/12/2020 19:20	0,08	56	4,76	CHI
2020122200034	RIO VERDE	MOT-TR1	CABRIUVA S2	22/12/2020 19:14	23/12/2020 00:38	22/12/2020 19:15	22/12/2020 19:46	0,52	77	39,74	CHI



2020122200034	MONTIVIDIU	RV10409400	MONTIVIDIU T	22/12/2020 19:14	23/12/2020 00:38	22/12/2020 19:15	22/12/2020 19:46	0,52	4	2,06	CHI
2020122200034	RIO VERDE	RV10409400	MONTIVIDIU T	22/12/2020 19:14	23/12/2020 00:38	22/12/2020 19:15	22/12/2020 19:46	0,52	66	34,06	CHI
2020122200034	MONTIVIDIU	MOT-TR1	MONTIVIDIU T	22/12/2020 19:14	23/12/2020 00:38	22/12/2020 19:15	22/12/2020 19:54	0,66	2201	1462,44	CHI
2020122200034	MONTIVIDIU	MOT-TR1	MONTIVIDIU T	22/12/2020 19:14	23/12/2020 00:38	22/12/2020 19:15	22/12/2020 19:54	0,66	1738	1154,80	CHI
2020122200034	RIO VERDE	MOT-TR1	MONTIVIDIU T	22/12/2020 19:14	23/12/2020 00:38	22/12/2020 19:15	22/12/2020 19:54	0,66	1	0,66	CHI
2020122200034	CAIAPONIA	MOT-TR1	MONTIVIDIU T	22/12/2020 19:14	23/12/2020 00:38	22/12/2020 19:15	22/12/2020 19:54	0,66	42	27,91	CHI
2020122200034	RIO VERDE	MOT-TR1	MONTIVIDIU T	22/12/2020 19:14	23/12/2020 00:38	22/12/2020 19:15	22/12/2020 19:54	0,66	81	53,82	CHI
2020122200034	RIO VERDE	MOT-TR1	MONTIVIDIU T	22/12/2020 19:14	23/12/2020 00:38	22/12/2020 19:15	22/12/2020 19:54	0,66	20	13,29	CHI
2020122200034	RIO VERDE	MOT-TR1	MONTIVIDIU T	22/12/2020 19:14	23/12/2020 00:38	22/12/2020 19:15	22/12/2020 19:54	0,66	3	1,99	CHI
2020122200034	JATAI	MOT-TR1	MONTIVIDIU T	22/12/2020 19:14	23/12/2020 00:38	22/12/2020 19:15	22/12/2020 19:54	0,66	7	4,65	CHI
2020122200034	MONTIVIDIU	MOT-TR1	MONTIVIDIU T	22/12/2020 19:14	23/12/2020 00:38	22/12/2020 19:15	22/12/2020 19:54	0,66	211	140,20	CHI
2020122200034	MONTIVIDIU	MOT-TR1	MONTIVIDIU T	22/12/2020 19:14	23/12/2020 00:38	22/12/2020 19:15	22/12/2020 19:54	0,66	6	3,99	CHI
2020122200034	CAIAPONIA	MOT-TR1	MONTIVIDIU T	22/12/2020 19:14	23/12/2020 00:38	22/12/2020 19:15	22/12/2020 19:54	0,66	285	189,37	CHI
2020122200034	MONTIVIDIU	MOT-TR1	MONTIVIDIU T	22/12/2020 19:14	23/12/2020 00:38	22/12/2020 19:15	22/12/2020 19:54	0,66	374	248,50	CHI
2020122200034	RIO VERDE	MV10226416	PARAUNA	22/12/2020 19:14	23/12/2020 00:38	22/12/2020 19:15	22/12/2020 20:06	0,86	2	1,72	CHI
2020122200034	PARAUNA	MV10226416	MONTIVIDIU T	22/12/2020 19:14	23/12/2020 00:38	22/12/2020 19:15	22/12/2020 20:06	0,86	151	129,61	CHI
2020122200034	MONTIVIDIU	MV10226416	MONTIVIDIU T	22/12/2020 19:14	23/12/2020 00:38	22/12/2020 19:15	22/12/2020 20:06	0,86	174	149,35	CHI
2020122200034	RIO VERDE	MV10226416	MONTIVIDIU T	22/12/2020 19:14	23/12/2020 00:38	22/12/2020 19:15	22/12/2020 20:06	0,86	385	330,46	CHI
2020122200034	IVOLANDIA	MV10226416	MONTIVIDIU T	22/12/2020 19:14	23/12/2020 00:38	22/12/2020 19:15	22/12/2020 20:06	0,86	29	24,89	CHI
2020122200034	CAIAPONIA	MV10226416	MONTIVIDIU T	22/12/2020 19:14	23/12/2020 00:38	22/12/2020 19:15	22/12/2020 20:06	0,86	135	115,88	CHI
2020122200034	PARAUNA	MV10226416	PARAUNA	22/12/2020 19:14	23/12/2020 00:38	22/12/2020 19:15	22/12/2020 20:06	0,86	149	127,89	CHI
2020122200034	MONTIVIDIU	RV13080904	MONTIVIDIU T	22/12/2020 19:14	23/12/2020 00:38	22/12/2020 22:22	22/12/2020 22:26	0,06	16	1,02	CHI
2020122200034	RIO VERDE	RV13080904	MONTIVIDIU T	22/12/2020 19:14	23/12/2020 00:38	22/12/2020 22:22	22/12/2020 22:26	0,06	62	3,94	CHI
2020122200034	RIO VERDE	RV10401437	MONTIVIDIU T	22/12/2020 19:14	23/12/2020 00:38	22/12/2020 20:01	23/12/2020 00:37	4,61	97	447,04	CHI
2020122200034	RIO VERDE	RV10401437	MONTIVIDIU T	22/12/2020 19:14	23/12/2020 00:38	22/12/2020 20:01	23/12/2020 00:38	4,63	27	124,95	CHI
202012128174	RIO VERDE	RV12260255	RIO VERDE S1	22/12/2020 19:15	22/12/2020 21:57	22/12/2020 19:15	22/12/2020 21:57	2,69	5	13,47	CHI
202012128337	RIO VERDE	RV12025958	RIO VERDE S1	22/12/2020 19:16	22/12/2020 23:37	22/12/2020 19:16	22/12/2020 23:37	4,34	47	203,80	CHI
202012128025	CRIXAS	IW12211868	RUBIATABA	22/12/2020 19:17	23/12/2020 11:07	22/12/2020 19:17	23/12/2020 11:07	15,83	13	205,74	CHI
202012128025	GUARINOS	IW12211868	RUBIATABA	22/12/2020 19:17	23/12/2020 11:07	22/12/2020 19:17	23/12/2020 11:07	15,83	5	79,13	CHI
202012128025	ITAPACI	IW12211868	RUBIATABA	22/12/2020 19:17	23/12/2020 11:07	22/12/2020 19:17	23/12/2020 11:07	15,83	19	300,70	CHI
202012128340	MINEIROS	MY12070299	PARQUE DAS EMAS	22/12/2020 19:17	24/12/2020 11:36	22/12/2020 19:17	24/12/2020 11:36	40,32	29	1169,26	CHI
202012128045	CRIXAS	CX12391833	RUBIATABA	22/12/2020 19:18	23/12/2020 16:17	22/12/2020 19:18	23/12/2020 16:17	20,97	6	125,84	CHI
202012128045	NOVA IGUACU DE GOIAS	CX12391833	RUBIATABA	22/12/2020 19:18	23/12/2020 16:17	22/12/2020 19:18	23/12/2020 16:17	20,97	1	20,97	CHI
202012128483	TURVELANDIA	EU12026747	RIO DOS BOIS	22/12/2020 19:20	23/12/2020 00:08	22/12/2020 19:20	23/12/2020 00:08	4,78	17	81,34	CHI
202012128483	ACREUNA	EU12026747	RIO DOS BOIS	22/12/2020 19:20	23/12/2020 00:08	22/12/2020 19:20	23/12/2020 00:08	4,78	11	52,63	CHI
202012128336	RIO VERDE	RV12371510	RIO VERDE S1	22/12/2020 19:23	22/12/2020 22:45	22/12/2020 19:23	22/12/2020 22:45	3,36	37	124,31	CHI
202012128131	FLORES DE GOIAS	FA12404371	ITIQUEIRA	22/12/2020 19:25	22/12/2020 21:33	22/12/2020 19:25	22/12/2020 21:33	2,13	1	2,13	CHI
202012128131	FORMOSA	FA12404371	ITIQUEIRA	22/12/2020 19:25	22/12/2020 21:33	22/12/2020 19:25	22/12/2020 21:33	2,13	90	191,50	CHI
202012128426	CRISTALINA	KR12336415	CRISTALINA S2	22/12/2020 19:26	23/12/2020 09:49	22/12/2020 19:26	23/12/2020 09:49	14,38	19	273,27	CHI
202012128115	IPORA	730080511	IPORA	22/12/2020 19:27	23/12/2020 07:18	22/12/2020 19:27	23/12/2020 07:18	11,84	1	11,84	CHI
202012128122	MAIRIPOTABA	MI12011393	PONTALINA	22/12/2020 19:29	22/12/2020 20:56	22/12/2020 19:29	22/12/2020 20:56	1,44	29	41,87	CHI
202012128128	VALPARAISO DE GOIAS	VA11047010	MARAJOARA	22/12/2020 19:30	22/12/2020 23:23	22/12/2020 19:30	22/12/2020 23:23	3,88	7	27,17	CHI
202012128129	SANTA TEREZA DE GOIAS	TB12170075	PORANGATU	22/12/2020 19:30	23/12/2020 08:32	22/12/2020 19:30	23/12/2020 08:32	13,03	3	39,09	CHI
202012128136	GOIANIA	GN12000542	CAMPINAS S3	22/12/2020 19:31	23/12/2020 01:19	22/12/2020 19:31	23/12/2020 01:19	5,79	308	1782,04	CHI
202012128137	ITAPACI	IW11000007	ITAPACI	22/12/2020 19:31	23/12/2020 00:27	22/12/2020 19:31	23/12/2020 00:27	4,92	80	393,38	CHI
202012128259	VALPARAISO DE GOIAS	VA12170158	PACAEMBU S1	22/12/2020 19:31	22/12/2020 21:40	22/12/2020 19:31	22/12/2020 21:40	2,14	309	662,12	CHI
202012128248	CALDAS NOVAS	CN11162460	CALDAS NOVAS S1	22/12/2020 19:33	22/12/2020 22:32	22/12/2020 19:33	22/12/2020 22:32	2,97	56	166,55	CHI
202012128335	FORMOSA	FA12330238	ITIQUEIRA	22/12/2020 19:33	23/12/2020 14:02	22/12/2020 19:33	23/12/2020 14:02	18,47	2	36,94	CHI
202012128152	CACU	CC12191711	CACHOEIRA ALTA	22/12/2020 19:34	23/12/2020 00:21	22/12/2020 19:34	23/12/2020 00:21	4,78	1	4,78	CHI
202012128751	CRISTALINA	KR12101526	CRISTALINA S1	22/12/2020 19:34	23/12/2020 00:33	22/12/2020 19:34	23/12/2020 00:33	4,97	54	268,65	CHI
202012128751	LUZIANIA	KR12101526	CRISTALINA S1	22/12/2020 19:34	23/12/2020 00:33	22/12/2020 19:34	23/12/2020 00:33	4,97	29	144,27	CHI

202012128521	FORMOSA	FA12282335	ITIQUEIRA	22/12/2020 19:36	23/12/2020 01:23	22/12/2020 19:36	23/12/2020 01:23	5,78	6	34,68	CHI
202012128180	ACREUNA	EU12301458	ACREUNA	22/12/2020 19:37	23/12/2020 11:47	22/12/2020 19:37	23/12/2020 11:47	16,16	1	16,16	CHI
202012128607	RIO VERDE	RV12279519	RIO VERDE S1	22/12/2020 19:42	23/12/2020 00:37	22/12/2020 19:42	23/12/2020 00:37	4,91	36	176,85	CHI
202012128243	ITUMBIARA	IT12222546	PARANAIBA	22/12/2020 19:43	23/12/2020 10:30	22/12/2020 19:43	23/12/2020 10:30	14,78	87	1286,10	CHI
202012128244	MINACU	4020039162	MINACU	22/12/2020 19:43	23/12/2020 00:30	22/12/2020 19:43	23/12/2020 00:30	4,78	1	4,78	CHI
202012128255	MAURILANDIA	10017982128	RIO DOS BOIS	22/12/2020 19:44	23/12/2020 10:55	22/12/2020 19:44	23/12/2020 10:55	15,19	1	15,19	CHI
202012128436	ITABERAI	IB12025649	ITABERAI S2	22/12/2020 19:47	23/12/2020 09:12	22/12/2020 19:47	23/12/2020 09:12	13,42	7	93,96	CHI
202012128292	INHUMAS	03640224	INHUMAS S1	22/12/2020 19:50	23/12/2020 17:29	22/12/2020 19:50	22/12/2020 20:59	1,16	41	47,63	CHI
202012128292	CATURAI	03640224	INHUMAS S1	22/12/2020 19:50	23/12/2020 17:29	22/12/2020 19:50	22/12/2020 20:59	1,16	94	109,20	CHI
202012128292	CATURAI	03640224	INHUMAS S1	22/12/2020 19:50	23/12/2020 17:29	22/12/2020 19:50	23/12/2020 09:10	13,33	253	3372,28	CHI
202012128292	CATURAI	03640224	INHUMAS S1	22/12/2020 19:50	23/12/2020 17:29	22/12/2020 19:50	23/12/2020 09:17	13,45	30	403,38	CHI
202012128292	INHUMAS	03640224	INHUMAS S1	22/12/2020 19:50	23/12/2020 17:29	22/12/2020 19:50	23/12/2020 09:17	13,45	2	26,89	CHI
202012128292	CATURAI	03640224	INHUMAS S1	22/12/2020 19:50	23/12/2020 17:29	22/12/2020 19:50	23/12/2020 17:28	21,63	1	21,63	CHI
202012128292	CATURAI	03640224	INHUMAS S1	22/12/2020 19:50	23/12/2020 17:29	22/12/2020 19:50	23/12/2020 17:29	21,65	0	0,00	CHI
202012128301	CUMARI	CY12063965	CATALAO S2	22/12/2020 19:52	23/12/2020 00:04	22/12/2020 19:52	23/12/2020 00:04	4,19	4	16,77	CHI
202012128308	JATAI	JT12213671	JATAI S1	22/12/2020 19:53	23/12/2020 08:51	22/12/2020 19:53	23/12/2020 08:51	12,96	5	64,82	CHI
202012128309	RIO VERDE	10021547830	RIO VERDE S1	22/12/2020 19:53	23/12/2020 07:40	22/12/2020 19:53	23/12/2020 07:40	11,79	1	11,79	CHI
202012128322	CAMPO ALEGRE DE GOIAS	CM12064010	CAMPO ALEGRE DE GOIAS	22/12/2020 19:54	23/12/2020 08:53	22/12/2020 19:54	23/12/2020 08:53	12,97	2	25,93	CHI
202012128413	CACHOEIRA DOURADA	CD12000005	CACHOEIRA DOURADA	22/12/2020 19:54	23/12/2020 15:33	22/12/2020 19:54	22/12/2020 23:52	3,96	8	31,65	CHI
202012128413	ITUMBIARA	CD12000005	CACHOEIRA DOURADA	22/12/2020 19:54	23/12/2020 15:33	22/12/2020 19:54	22/12/2020 23:52	3,96	1	3,96	CHI
202012128413	CACHOEIRA DOURADA	CD12000005	CACHOEIRA DOURADA	22/12/2020 19:54	23/12/2020 15:33	22/12/2020 22:38	22/12/2020 23:52	1,23	8	9,84	CHI
202012128413	ITUMBIARA	CD12000005	CACHOEIRA DOURADA	22/12/2020 19:54	23/12/2020 15:33	22/12/2020 19:54	23/12/2020 13:01	17,11	2	34,22	CHI
202012128413	CACHOEIRA DOURADA	CD12000005	CACHOEIRA DOURADA	22/12/2020 19:54	23/12/2020 15:33	22/12/2020 19:54	23/12/2020 13:01	17,11	1	17,11	CHI
202012128413	ITUMBIARA	CD12000005	CACHOEIRA DOURADA	22/12/2020 19:54	23/12/2020 15:33	22/12/2020 19:54	23/12/2020 15:10	19,25	9	173,29	CHI
202012128413	ITUMBIARA	CD12000005	CACHOEIRA DOURADA	22/12/2020 19:54	23/12/2020 15:33	22/12/2020 19:54	23/12/2020 15:33	19,65	10	196,45	CHI
202012128330	IPAMERI	580023928	IPAMERI	22/12/2020 19:55	22/12/2020 22:35	22/12/2020 19:55	22/12/2020 22:35	2,66	1	2,66	CHI
202012128331	MARA ROSA	2260043313	MARA ROSA	22/12/2020 19:56	23/12/2020 02:34	22/12/2020 19:56	23/12/2020 02:34	6,64	1	6,64	CHI
202012128342	MINEIROS	MY12303343RE	PARQUE DAS EMAS	22/12/2020 19:57	23/12/2020 14:48	22/12/2020 19:57	23/12/2020 14:48	18,86	32	603,43	CHI
202012128380	CRISTIANOPOLIS	CF12086343	CRISTIANOPOLIS	22/12/2020 20:04	22/12/2020 22:22	22/12/2020 20:04	22/12/2020 22:22	2,30	4	9,21	CHI
202012128747	ANAPOLIS	21023542	ANAPOLIS UNIVERSITARIO S2	22/12/2020 20:04	22/12/2020 23:11	22/12/2020 20:04	22/12/2020 23:11	3,11	1	3,11	CHI
202012128385	ANICUNS	AC12075540	ANICUNS	22/12/2020 20:05	23/12/2020 12:14	22/12/2020 20:05	23/12/2020 12:14	16,14	2	32,29	CHI
202012128390	PANAMA	PX12375443	GOIATUBA S1	22/12/2020 20:06	23/12/2020 09:22	22/12/2020 20:06	23/12/2020 09:22	13,25	3	39,76	CHI
202012128391	BELA VISTA DE GOIAS	BV21011699	BELA VISTA S1	22/12/2020 20:07	23/12/2020 00:55	22/12/2020 20:07	23/12/2020 00:55	4,80	1	4,80	CHI
202012128534	HIDROLANDIA	HD12365522	CEPAIGO S2	22/12/2020 20:10	23/12/2020 05:33	22/12/2020 20:10	23/12/2020 05:33	9,38	137	1285,52	CHI
202012128594	SAO LUIS DE MONTES BELOS	SL11194189	SAO LUIZ DOS MONTES BELOS	22/12/2020 20:10	22/12/2020 23:36	22/12/2020 20:10	22/12/2020 23:36	3,43	8	27,43	CHI
202012128419	TRINDADE	TR12311261	TRINDADE	22/12/2020 20:14	22/12/2020 22:11	22/12/2020 20:14	22/12/2020 22:11	1,95	234	456,30	CHI
202012128454	MORRINHOS	MR12125522	MORRINHOS	22/12/2020 20:16	22/12/2020 22:43	22/12/2020 20:16	22/12/2020 22:43	2,44	31	75,64	CHI
202012128437	PORANGATU	PO12036063	PORANGATU	22/12/2020 20:18	23/12/2020 13:46	22/12/2020 20:18	23/12/2020 12:41	16,39	16	262,32	CHI
202012128437	PORANGATU	PO12036063	PORANGATU	22/12/2020 20:18	23/12/2020 13:46	22/12/2020 20:18	23/12/2020 13:11	16,90	24	405,53	CHI
202012128437	PORANGATU	PO12036063	PORANGATU	22/12/2020 20:18	23/12/2020 13:46	22/12/2020 20:18	23/12/2020 13:46	17,47	20	349,47	CHI
202012128463	CRISTIANOPOLIS	CF12363982	CRISTIANOPOLIS	22/12/2020 20:22	23/12/2020 00:23	22/12/2020 20:22	23/12/2020 00:23	4,00	9	36,03	CHI
202012128478	GOIANDIRA	GD12281470	CATALAO S1	22/12/2020 20:24	23/12/2020 00:20	22/12/2020 20:24	23/12/2020 00:20	3,93	5	19,64	CHI
202012128615	BURITI DE GOIAS	BS12252226	FIRMINOPOLIS S2	22/12/2020 20:25	22/12/2020 22:29	22/12/2020 20:25	22/12/2020 22:29	2,06	14	28,77	CHI
202012128493	CACHOEIRA ALTA	CA21247852	CACHOEIRA ALTA	22/12/2020 20:27	23/12/2020 02:10	22/12/2020 20:27	23/12/2020 02:10	5,73	1	5,73	CHI
202012128498	CALDAS NOVAS	760006027	SERRA DE CALDAS	22/12/2020 20:28	23/12/2020 00:17	22/12/2020 20:28	23/12/2020 00:17	3,82	1	3,82	CHI
202012128504	SILVANIA	SV12080304	BIANOPOLIS	22/12/2020 20:30	23/12/2020 03:53	22/12/2020 20:30	23/12/2020 03:53	7,38	5	36,91	CHI
202012128721	JUSSARA	JR12259810	BRITANIA	22/12/2020 20:30	23/12/2020 00:07	22/12/2020 20:30	23/12/2020 00:07	3,61	49	176,94	CHI
202012128528	FORMOSA	FA12383252	ITIQUEIRA	22/12/2020 20:34	23/12/2020 13:14	22/12/2020 20:34	23/12/2020 13:14	16,67	1	16,67	CHI
202012128530	SAO MIGUEL DO ARAGUAIA	SM12000050	SAO MIGUEL DO ARAGUAIA	22/12/2020 20:34	24/12/2020 01:03	22/12/2020 20:34	24/12/2020 01:03	28,48	16	455,67	CHI
202012128530	SAO MIGUEL DO ARAGUAIA	SM12000050	SAO MIGUEL DO ARAGUAIA	22/12/2020 20:34	24/12/2020 01:03	23/12/2020 21:09	24/12/2020 01:03	3,91	13	50,83	CHI
202012128540	PIRACANJUBA	PJ12226339	PIRACANJUBA	22/12/2020 20:37	23/12/2020 08:55	22/12/2020 20:37	23/12/2020 08:55	12,30	61	750,05	CHI

202012128555	EDEALINA	ED11000002	PONTALINA	22/12/2020 20:39	22/12/2020 22:20	22/12/2020 20:39	22/12/2020 22:20	1,68	189	317,57	CHI
202012128575	LUZIANIA	LZ12304992	VIANOPOLIS	22/12/2020 20:41	23/12/2020 13:21	22/12/2020 20:41	23/12/2020 11:05	14,40	70	1007,75	CHI
202012128575	LUZIANIA	LZ12304992	VIANOPOLIS	22/12/2020 20:41	23/12/2020 13:21	22/12/2020 20:41	23/12/2020 13:21	16,66	5	83,32	CHI
202012128597	CAIAPONIA	CP12155495	CAIAPONIA	22/12/2020 20:41	23/12/2020 11:26	22/12/2020 20:41	23/12/2020 11:26	14,75	10	147,52	CHI
202012128592	MINEIROS	O2610434	PARQUE DAS EMAS	22/12/2020 20:43	24/12/2020 04:40	22/12/2020 20:46	23/12/2020 00:01	3,25	2	6,50	CHI
202012128592	MINEIROS	MY13164251	PARQUE DAS EMAS	22/12/2020 20:43	24/12/2020 04:40	22/12/2020 20:46	24/12/2020 04:00	31,23	10	312,26	CHI
202012128592	MINEIROS	MY13164252	PARQUE DAS EMAS	22/12/2020 20:43	24/12/2020 04:40	22/12/2020 20:46	24/12/2020 04:40	31,89	27	861,11	CHI
202012128579	CATALAO	CT21292302	CATALAO S1	22/12/2020 20:46	23/12/2020 03:20	22/12/2020 20:46	23/12/2020 02:44	5,96	1	5,96	CHI
202012128579	CATALAO	CT12333737	CATALAO S1	22/12/2020 20:46	23/12/2020 03:20	23/12/2020 00:20	23/12/2020 03:20	2,99	1	2,99	CHI
202012128589	GOIAS	HE12023221	ITAPURANGA	22/12/2020 20:50	24/12/2020 16:38	22/12/2020 20:50	23/12/2020 21:40	24,83	10	248,26	CHI
202012128589	HEITORAI	HE12023221	ITAPURANGA	22/12/2020 20:50	24/12/2020 16:38	22/12/2020 20:50	23/12/2020 21:40	24,83	18	446,87	CHI
202012128589	ITAPURANGA	HE12023221	ITAPURANGA	22/12/2020 20:50	24/12/2020 16:38	22/12/2020 20:50	23/12/2020 21:40	24,83	67	1663,35	CHI
202012128589	HEITORAI	HE12023221	ITAPURANGA	22/12/2020 20:50	24/12/2020 16:38	24/12/2020 11:13	24/12/2020 16:32	5,32	19	101,10	CHI
202012128589	ITAPURANGA	HE12023221	ITAPURANGA	22/12/2020 20:50	24/12/2020 16:38	24/12/2020 11:13	24/12/2020 16:32	5,32	67	356,51	CHI
202012128589	GOIAS	HE12023221	ITAPURANGA	22/12/2020 20:50	24/12/2020 16:38	24/12/2020 11:13	24/12/2020 16:32	5,32	10	53,21	CHI
202012128589	HEITORAI	7543278	ITAPURANGA	22/12/2020 20:50	24/12/2020 16:38	22/12/2020 20:50	24/12/2020 16:38	43,80	1	43,80	CHI
202012128620	MIMOSO DE GOIAS	MJ12286897	PADRE BERNARDO	22/12/2020 20:57	22/12/2020 22:51	22/12/2020 20:57	22/12/2020 22:51	1,89	12	22,66	CHI
202012128685	MONTIVIDIU	O2610414	PARQUE DAS EMAS	22/12/2020 20:57	22/12/2020 21:17	22/12/2020 20:57	22/12/2020 21:17	0,35	1	0,35	CHI
202012128685	MINEIROS	O2610414	PARQUE DAS EMAS	22/12/2020 20:57	22/12/2020 21:17	22/12/2020 20:57	22/12/2020 21:17	0,35	64	22,17	CHI
202012128685	PORTELANDIA	O2610414	PARQUE DAS EMAS	22/12/2020 20:57	22/12/2020 21:17	22/12/2020 20:57	22/12/2020 21:17	0,35	11	3,81	CHI
202012128685	MINEIROS	O2610414	PARQUE DAS EMAS	22/12/2020 20:57	22/12/2020 21:17	22/12/2020 20:57	22/12/2020 21:17	0,35	10	3,46	CHI
202012128628	TRINDADE	10023438710	GOYA S2	22/12/2020 20:59	22/12/2020 22:48	22/12/2020 20:59	22/12/2020 22:48	1,82	1	1,82	CHI
202012128670	NOVO GAMA	NJ11276292	PACAEMBU S2	22/12/2020 21:09	23/12/2020 03:14	22/12/2020 21:09	23/12/2020 03:14	6,07	2	12,14	CHI
202012128672	PROFESSOR JAMIL SAFADY	JS12163474	ROCHEDO	22/12/2020 21:10	23/12/2020 00:02	22/12/2020 21:10	23/12/2020 00:02	2,85	12	34,26	CHI
202012128686	BELA VISTA DE GOIAS	BV12041021	BELA VISTA S1	22/12/2020 21:15	22/12/2020 22:55	22/12/2020 21:15	22/12/2020 22:55	1,65	5	8,27	CHI
202012128696	GOIANIA	GN12080301	FERROVIARIO S2	22/12/2020 21:19	23/12/2020 02:29	22/12/2020 21:19	23/12/2020 02:29	5,17	93	480,40	CHI
202012128707	SANTO ANTONIO DA BARRA	BZ12301384LD	ACREUNA	22/12/2020 21:23	23/12/2020 08:50	22/12/2020 21:23	23/12/2020 08:50	11,45	2	22,90	CHI
202012128736	ORIZONA	OZ121114547	PIRES DO RIO S2	22/12/2020 21:24	22/12/2020 23:13	22/12/2020 21:24	22/12/2020 23:13	1,82	9	16,34	CHI
202012128731	JANDAIA	JD12308479	PALMEIRAS	22/12/2020 21:26	23/12/2020 04:07	22/12/2020 21:26	23/12/2020 04:07	6,68	5	33,42	CHI
202012128727	PROFESSOR JAMIL SAFADY	JS12000104	ROCHEDO	22/12/2020 21:29	23/12/2020 05:16	22/12/2020 21:29	23/12/2020 05:16	7,78	19	147,86	CHI
202012128729	ANAPOLIS	10007448587	JUNDIAI S2	22/12/2020 21:29	23/12/2020 02:36	22/12/2020 21:29	23/12/2020 02:36	5,12	1	5,12	CHI
202012128738	CUMARI	AH12082019	CATALAO S1	22/12/2020 21:34	23/12/2020 11:42	22/12/2020 21:34	23/12/2020 11:42	14,13	2	28,26	CHI
202012128753	SANTO ANTONIO DO DESCOBERTO	SN12290826	PACAEMBU S1	22/12/2020 21:41	23/12/2020 01:55	22/12/2020 21:41	23/12/2020 01:55	4,23	17	71,91	CHI
202012128753	NOVO GAMA	SN12290826	PACAEMBU S1	22/12/2020 21:41	23/12/2020 01:55	22/12/2020 21:41	23/12/2020 01:55	4,23	4	16,92	CHI
202012129205	CRISTALINA	KR12389576	CRISTALINA S2	22/12/2020 21:45	23/12/2020 09:14	22/12/2020 21:45	23/12/2020 09:14	11,47	39	447,47	CHI
202012128770	BOM JARDIM DE GOIAS	BM12070982	BOM JARDIM	22/12/2020 21:46	23/12/2020 02:44	22/12/2020 21:46	23/12/2020 02:44	4,96	5	24,79	CHI
202012128784	GOIANIA	GN11161887	GOIANIA LESTE S2	22/12/2020 21:47	23/12/2020 11:25	22/12/2020 21:47	23/12/2020 11:25	13,63	60	817,63	CHI
202012129658	SANTA CRUZ DE GOIAS	BC12083189	PIRES DO RIO S2	22/12/2020 21:48	23/12/2020 08:31	22/12/2020 21:48	23/12/2020 08:31	10,70	8	85,62	CHI
202012128783	ANICUNS	TV12005709	FIRMINOPOLIS S2	22/12/2020 21:52	23/12/2020 01:15	22/12/2020 21:52	23/12/2020 01:15	3,37	18	60,68	CHI
202012128785	QUIRINOPOLIS	QI32035326	QUIRINOPOLIS	22/12/2020 21:53	23/12/2020 10:55	22/12/2020 21:53	23/12/2020 10:55	13,03	5	65,15	CHI
202012129536	PIRES DO RIO	PR12000044RE	PIRES DO RIO S1	22/12/2020 21:53	23/12/2020 08:59	22/12/2020 21:53	23/12/2020 08:59	11,09	79	876,37	CHI
202012129536	ORIZONA	PR12000044RE	PIRES DO RIO S1	22/12/2020 21:53	23/12/2020 08:59	22/12/2020 21:53	23/12/2020 08:59	11,09	11	122,03	CHI
202012129678	IPAMERI	IP12247907	CRISTALINA S2	22/12/2020 21:53	23/12/2020 10:18	22/12/2020 21:53	23/12/2020 10:18	12,41	24	297,73	CHI
202012128803	RIO VERDE	RV12303286	CABRIUVA S2	22/12/2020 21:59	23/12/2020 03:17	22/12/2020 21:59	23/12/2020 03:17	5,28	9	47,56	CHI
202012128816	JATAI	JT12060154	JATAI S2	22/12/2020 22:11	23/12/2020 08:11	22/12/2020 22:11	23/12/2020 08:11	10,00	3	29,99	CHI
202012128817	ANICUNS	AC12304588	FIRMINOPOLIS S2	22/12/2020 22:11	23/12/2020 13:03	22/12/2020 22:11	23/12/2020 13:03	14,86	2	29,71	CHI
202012128829	MINEIROS	MY12164239	PARQUE DAS EMAS	22/12/2020 22:17	23/12/2020 09:12	22/12/2020 22:17	23/12/2020 09:12	10,91	3	32,72	CHI
202012128833	RIO VERDE	630540627	CABRIUVA S1	22/12/2020 22:18	23/12/2020 00:00	22/12/2020 22:18	23/12/2020 00:00	1,70	1	1,70	CHI
202012130244	IPAMERI	IP12300933	IPAMERI	22/12/2020 22:20	23/12/2020 08:40	22/12/2020 22:20	23/12/2020 08:40	10,32	58	598,72	CHI
202012130244	URUTAI	IP12300933	IPAMERI	22/12/2020 22:20	23/12/2020 08:40	22/12/2020 22:20	23/12/2020 08:40	10,32	4	41,29	CHI
202012131349	CROMINIA	MI12046316	PONTALINA	22/12/2020 22:20	23/12/2020 10:55	22/12/2020 22:20	23/12/2020 10:55	12,58	3	37,73	CHI

202012128840	PORANGATU	PO12189561	PORANGATU	22/12/2020 22:22	23/12/2020 09:15	22/12/2020 22:22	23/12/2020 09:15	10,87	7	76,09	CHI
202012128945	PARAUNA	PU12336680	PARAUNA	22/12/2020 22:23	23/12/2020 20:33	22/12/2020 22:23	23/12/2020 14:10	15,78	20	315,62	CHI
202012128945	PARAUNA	PU12336680	PARAUNA	22/12/2020 22:23	23/12/2020 20:33	22/12/2020 22:23	23/12/2020 17:45	19,35	20	387,02	CHI
202012128945	PARAUNA	PU13323188	PARAUNA	22/12/2020 22:23	23/12/2020 20:33	23/12/2020 18:13	23/12/2020 20:18	2,08	20	41,51	CHI
202012128945	PARAUNA	PU12336680	PARAUNA	22/12/2020 22:23	23/12/2020 20:33	22/12/2020 22:23	23/12/2020 20:33	22,16	1	22,16	CHI
202012128847	PIRES DO RIO	PR12000028	PIRES DO RIO S1	22/12/2020 22:24	23/12/2020 12:00	22/12/2020 22:24	23/12/2020 12:00	13,59	3	40,76	CHI
202012128849	APARECIDA DE GOIANIA	10021456869	REAL S1	22/12/2020 22:25	23/12/2020 06:27	22/12/2020 22:25	23/12/2020 06:27	8,04	1	8,04	CHI
202012128854	ANAPOLIS	10016397981	JUNDIAI S2	22/12/2020 22:27	23/12/2020 01:05	22/12/2020 22:27	23/12/2020 01:05	2,63	1	2,63	CHI
202012129298	GOIATUBA	GT12296905	GOIATUBA S2	22/12/2020 22:33	23/12/2020 09:10	22/12/2020 22:33	23/12/2020 09:10	10,60	7	74,22	CHI
202012128944	JUSSARA	JR12008743	BRITANIA	22/12/2020 22:34	23/12/2020 04:01	22/12/2020 22:34	23/12/2020 04:01	5,44	38	206,61	CHI
202012128875	ANAPOLIS	20480921	JUNDIAI S1	22/12/2020 22:36	23/12/2020 05:11	22/12/2020 22:36	23/12/2020 05:11	6,58	1	6,58	CHI
202012130483	PIRACANJUBA	PJ12000075	PIRACANJUBA	22/12/2020 23:17	23/12/2020 09:42	22/12/2020 23:17	23/12/2020 09:42	10,41	48	499,61	CHI
202012128974	BELA VISTA DE GOIAS	BV12011703	BELA VISTA S1	22/12/2020 23:20	23/12/2020 00:52	22/12/2020 23:20	23/12/2020 00:52	1,53	8	12,26	CHI
202012128987	IPORA	730080274	IPORA	22/12/2020 23:28	23/12/2020 09:30	22/12/2020 23:28	23/12/2020 09:30	10,04	1	10,04	CHI
202012130108	LUZIANIA	LZ12119965	PACAEMBU S2	22/12/2020 23:29	23/12/2020 09:23	22/12/2020 23:29	23/12/2020 09:23	9,89	17	168,17	CHI
202012129720	ANAPOLIS	AN12000026	ANAPOLIS UNIVERSITARIO S2	22/12/2020 23:32	23/12/2020 08:10	22/12/2020 23:32	23/12/2020 08:10	8,63	235	2027,72	CHI
202012130510	PIRACANJUBA	PJ12039733	PIRACANJUBA	22/12/2020 23:33	23/12/2020 10:32	22/12/2020 23:33	23/12/2020 10:32	10,97	25	274,20	CHI
202012130629	BRITANIA	BT12250825	BRITANIA	22/12/2020 23:36	23/12/2020 19:44	22/12/2020 23:36	23/12/2020 19:44	20,12	4	80,49	CHI
202012129016	URUTAI	PR12080258RE	URUTAI	22/12/2020 23:37	23/12/2020 07:38	22/12/2020 23:37	23/12/2020 07:38	8,01	63	504,39	CHI
202012129016	PIRES DO RIO	PR12080258RE	URUTAI	22/12/2020 23:37	23/12/2020 07:38	22/12/2020 23:37	23/12/2020 07:38	8,01	10	80,06	CHI
202012129191	LUZIANIA	OZ21114868	PIRES DO RIO S2	22/12/2020 23:46	23/12/2020 11:14	23/12/2020 06:21	23/12/2020 10:14	3,90	1	3,90	CHI
202012129191	LUZIANIA	OZ12195112	PIRES DO RIO S2	22/12/2020 23:46	23/12/2020 11:14	22/12/2020 23:46	23/12/2020 11:14	11,47	74	848,70	CHI
202012129238	ITAPIRAPUA	IU12020180LD	JUSSARA	22/12/2020 23:49	23/12/2020 19:49	22/12/2020 23:49	23/12/2020 19:49	19,99	88	1759,49	CHI
202012129238	ITAPIRAPUA	IU12020180LD	JUSSARA	22/12/2020 23:49	23/12/2020 19:49	23/12/2020 12:53	23/12/2020 19:49	6,93	2	13,85	CHI
202012131896	PIRANHAS	PH12380983	PIRANHAS	22/12/2020 23:58	23/12/2020 19:06	22/12/2020 23:58	23/12/2020 19:06	19,12	6	114,75	CHI
202012129031	CAMPO ALEGRE DE GOIAS	CM12266823	CAMPO ALEGRE DE GOIAS	23/12/2020 00:17	23/12/2020 06:46	23/12/2020 00:17	23/12/2020 06:46	6,48	44	285,18	CHI
202012129043	INACIOLANDIA	ID12371229	CACHOEIRA DOURADA	23/12/2020 00:33	23/12/2020 02:37	23/12/2020 00:33	23/12/2020 02:37	2,05	15	30,80	CHI
202012129054	NIQUELANDIA	NQ10396041	NIQUELANDIA SUBTRANSMISSAO	23/12/2020 00:51	24/12/2020 00:01	23/12/2020 00:51	23/12/2020 05:31	4,66	27	125,77	CHI
202012129054	NIQUELANDIA	NQ10396041	NIQUELANDIA SUBTRANSMISSAO	23/12/2020 00:51	24/12/2020 00:01	23/12/2020 00:51	23/12/2020 07:27	6,59	7	46,12	CHI
202012129054	NIQUELANDIA	NQ10396041	NIQUELANDIA SUBTRANSMISSAO	23/12/2020 00:51	24/12/2020 00:01	23/12/2020 11:59	23/12/2020 12:31	0,53	27	14,32	CHI
202012129054	NIQUELANDIA	NQ13374591	NIQUELANDIA SUBTRANSMISSAO	23/12/2020 00:51	24/12/2020 00:01	23/12/2020 08:22	23/12/2020 16:13	7,86	7	55,01	CHI
202012129054	NIQUELANDIA	NQ10396041	NIQUELANDIA SUBTRANSMISSAO	23/12/2020 00:51	24/12/2020 00:01	23/12/2020 00:51	23/12/2020 19:40	18,82	170	3198,97	CHI
202012129054	NIQUELANDIA	NQ13292584	NIQUELANDIA SUBTRANSMISSAO	23/12/2020 00:51	24/12/2020 00:01	23/12/2020 11:59	23/12/2020 19:40	7,68	1	7,68	CHI
202012129054	NIQUELANDIA	NQ13374591	NIQUELANDIA SUBTRANSMISSAO	23/12/2020 00:51	24/12/2020 00:01	23/12/2020 00:51	23/12/2020 22:53	22,03	79	1740,06	CHI
202012129054	NIQUELANDIA	NQ12235365LD	NIQUELANDIA SUBTRANSMISSAO	23/12/2020 00:51	24/12/2020 00:01	23/12/2020 00:51	24/12/2020 00:01	23,17	61	1413,23	CHI
202012129054	URUACU	NQ12235365LD	NIQUELANDIA SUBTRANSMISSAO	23/12/2020 00:51	24/12/2020 00:01	23/12/2020 00:51	24/12/2020 00:01	23,17	3	69,50	CHI
202012129066	VICENTINOPOLIS	VI12000025	VICENTINOPOLIS	23/12/2020 01:04	23/12/2020 07:41	23/12/2020 01:04	23/12/2020 07:41	6,61	3	19,84	CHI
202012129074	AMERICANO DO BRASIL	IB10395408	ITABERAI S2	23/12/2020 01:09	23/12/2020 14:38	23/12/2020 01:09	23/12/2020 10:27	9,29	12	111,48	CHI
202012129074	ITABERAI	IB10395408	ITABERAI S2	23/12/2020 01:09	23/12/2020 14:38	23/12/2020 01:09	23/12/2020 10:27	9,29	230	2136,70	CHI
202012129074	ITABERAI	IB12199000	ITABERAI S2	23/12/2020 01:09	23/12/2020 14:38	23/12/2020 01:09	23/12/2020 12:50	11,67	130	1517,21	CHI
202012129074	ITABERAI	IB10395408	ITABERAI S2	23/12/2020 01:09	23/12/2020 14:38	23/12/2020 01:09	23/12/2020 14:38	13,48	1	13,48	CHI
202012129734	PIRES DO RIO	PR12000071	PIRES DO RIO S1	23/12/2020 01:12	23/12/2020 08:14	23/12/2020 01:12	23/12/2020 08:14	7,03	74	520,47	CHI
202012129077	PADRE BERNARDO	PB12290547	PADRE BERNARDO	23/12/2020 01:15	23/12/2020 03:27	23/12/2020 01:15	23/12/2020 03:27	2,19	19	41,59	CHI
202012129593	BONOPOLIS	BX12168214	SAO MIGUEL DO ARAGUAIA	23/12/2020 01:17	23/12/2020 09:18	23/12/2020 01:17	23/12/2020 08:17	7,00	116	811,97	CHI
202012129593	BONOPOLIS	BX12168214	SAO MIGUEL DO ARAGUAIA	23/12/2020 01:17	23/12/2020 09:18	23/12/2020 01:17	23/12/2020 09:18	8,02	4	32,10	CHI
202012129593	BONOPOLIS	BX12364618	SAO MIGUEL DO ARAGUAIA	23/12/2020 01:17	23/12/2020 09:18	23/12/2020 08:17	23/12/2020 09:18	1,02	1	1,02	CHI
202012129667	JATAI	JT12303025	JATAI S1	23/12/2020 01:39	23/12/2020 23:43	23/12/2020 01:39	23/12/2020 23:43	22,06	7	154,40	CHI
202012129093	NOVA CRIXAS	NA12334349	NOVA CRIXAS	23/12/2020 01:46	23/12/2020 09:57	23/12/2020 01:46	23/12/2020 09:57	8,17	86	702,84	CHI
202012129095	SANTA HELENA DE GOIAS	SH10394752	IPEGUARI	23/12/2020 01:51	23/12/2020 13:36	23/12/2020 01:51	23/12/2020 10:24	8,54	82	700,62	CHI
202012129095	SANTA HELENA DE GOIAS	SH10394752	IPEGUARI	23/12/2020 01:51	23/12/2020 13:36	23/12/2020 01:51	23/12/2020 13:36	11,75	30	352,45	CHI
202012129102	GOIANIA	GN11000660	ATLANTICO S1	23/12/2020 02:07	23/12/2020 09:36	23/12/2020 02:07	23/12/2020 09:36	7,47	67	500,73	CHI

202012129569	BRAZABRANTES	7402296	INHUMAS S1	23/12/2020 02:20	23/12/2020 13:07	23/12/2020 02:20	23/12/2020 13:07	10,78	47	506,84	CHI
202012129569	NOVA VENEZA	7402296	INHUMAS S1	23/12/2020 02:20	23/12/2020 13:07	23/12/2020 02:20	23/12/2020 13:07	10,78	36	388,22	CHI
202012129569	PETROLINA DE GOIAS	7402296	INHUMAS S1	23/12/2020 02:20	23/12/2020 13:07	23/12/2020 02:20	23/12/2020 13:07	10,78	6	64,70	CHI
202012129569	INHUMAS	7402296	INHUMAS S1	23/12/2020 02:20	23/12/2020 13:07	23/12/2020 02:20	23/12/2020 13:07	10,78	20	215,68	CHI
202012129569	DAMOLANDIA	7402296	INHUMAS S1	23/12/2020 02:20	23/12/2020 13:07	23/12/2020 02:20	23/12/2020 13:07	10,78	172	1854,83	CHI
202012129569	OURO VERDE DE GOIAS	7402296	INHUMAS S1	23/12/2020 02:20	23/12/2020 13:07	23/12/2020 02:20	23/12/2020 13:07	10,78	139	1498,96	CHI
202012129569	DAMOLANDIA	03330224	INHUMAS S1	23/12/2020 02:20	23/12/2020 13:07	23/12/2020 11:25	23/12/2020 13:07	1,69	2	3,38	CHI
202012129109	MORRINHOS	MR12223454RE	MORRINHOS	23/12/2020 02:28	23/12/2020 08:25	23/12/2020 02:28	23/12/2020 08:25	5,95	15	89,22	CHI
202012129109	PONTALINA	MR12223454RE	MORRINHOS	23/12/2020 02:28	23/12/2020 08:25	23/12/2020 02:28	23/12/2020 08:25	5,95	5	29,74	CHI
202012129112	NOVA AMERICA	RB12114265RE	RUBIATABA	23/12/2020 02:32	23/12/2020 11:21	23/12/2020 02:32	23/12/2020 11:21	8,81	19	167,47	CHI
202012129112	RUBIATABA	RB12114265RE	RUBIATABA	23/12/2020 02:32	23/12/2020 11:21	23/12/2020 02:32	23/12/2020 11:21	8,81	84	740,41	CHI
202012129937	FORMOSA	FA12404372	ITUIQUIRA	23/12/2020 02:33	23/12/2020 13:31	23/12/2020 02:33	23/12/2020 13:31	10,96	166	1819,54	CHI
202012129735	CAIAPONIA	CP12291990	CAIAPONIA	23/12/2020 02:45	23/12/2020 08:42	23/12/2020 02:45	23/12/2020 08:42	5,93	19	112,76	CHI
202012129304	CATALAO	CT12195398RE	CATALAO S1	23/12/2020 03:14	24/12/2020 17:56	23/12/2020 03:14	23/12/2020 10:30	7,27	78	567,08	CHI
202012129304	CATALAO	CT12195398RE	CATALAO S1	23/12/2020 03:14	24/12/2020 17:56	23/12/2020 03:14	23/12/2020 11:54	8,67	3	26,01	CHI
202012129304	CATALAO	CT12195398RE	CATALAO S1	23/12/2020 03:14	24/12/2020 17:56	23/12/2020 03:14	23/12/2020 19:02	15,81	14	221,36	CHI
202012129304	CATALAO	CT12195398RE	CATALAO S1	23/12/2020 03:14	24/12/2020 17:56	23/12/2020 03:14	24/12/2020 17:56	38,70	12	464,38	CHI
202012129304	CATALAO	CT12266179	CATALAO S1	23/12/2020 03:14	24/12/2020 17:56	24/12/2020 15:52	24/12/2020 17:56	2,07	14	28,92	CHI
202012129162	ITAPIRAPUA	IU12250535	JUSSARA	23/12/2020 03:18	23/12/2020 14:45	23/12/2020 03:18	23/12/2020 14:45	11,45	16	183,19	CHI
202012129162	JUSSARA	IU12250535	JUSSARA	23/12/2020 03:18	23/12/2020 14:45	23/12/2020 03:18	23/12/2020 14:45	11,45	9	103,04	CHI
202012129159	NOVA CRIXAS	NA12035650	NOVA CRIXAS	23/12/2020 03:27	23/12/2020 08:31	23/12/2020 03:27	23/12/2020 08:31	5,07	23	116,52	CHI
202012129159	MUNDO NOVO DE GOIAS	NA12035650	NOVA CRIXAS	23/12/2020 03:27	23/12/2020 08:31	23/12/2020 03:27	23/12/2020 08:31	5,07	8	40,53	CHI
202012129309	ANAPOLIS	AN12258395	JUNDIAI S2	23/12/2020 03:41	23/12/2020 09:25	23/12/2020 03:41	23/12/2020 09:25	5,73	14	80,17	CHI
202012129144	SANTA TEREZINHA DE GOIAS	SG12181455	SANTA TEREZINHA	23/12/2020 03:44	23/12/2020 07:48	23/12/2020 03:44	23/12/2020 07:48	4,05	19	77,01	CHI
202012129418	ITUMBIARA	IT12316685	ITUMBIARA NOVA	23/12/2020 03:53	23/12/2020 08:13	23/12/2020 03:53	23/12/2020 08:13	4,33	41	177,40	CHI
202012129150	PONTALINA	MR12249786	GOIATUBA S1	23/12/2020 04:04	23/12/2020 08:14	23/12/2020 04:04	23/12/2020 08:14	4,16	6	24,97	CHI
202012129150	MORRINHOS	MR12249786	GOIATUBA S1	23/12/2020 04:04	23/12/2020 08:14	23/12/2020 04:04	23/12/2020 08:14	4,16	6	24,97	CHI
202012129150	ALOANDIA	MR12249786	GOIATUBA S1	23/12/2020 04:04	23/12/2020 08:14	23/12/2020 04:04	23/12/2020 08:14	4,16	15	62,42	CHI
202012129151	MARA ROSA	MQ12051944	MARA ROSA	23/12/2020 04:07	23/12/2020 09:18	23/12/2020 04:07	23/12/2020 09:18	5,18	1	5,18	CHI
202012129151	CAMPINORTE	MQ12051944	MARA ROSA	23/12/2020 04:07	23/12/2020 09:18	23/12/2020 04:07	23/12/2020 09:18	5,18	8	41,43	CHI
202012129153	CORUMBA DE GOIAS	CB12382397	CORUMBA	23/12/2020 04:08	23/12/2020 21:40	23/12/2020 04:08	23/12/2020 21:40	17,53	33	578,43	CHI
202012129424	AMARALINA	MU12391653	MARA ROSA	23/12/2020 04:08	23/12/2020 07:57	23/12/2020 04:08	23/12/2020 07:57	3,81	21	80,11	CHI
202012129391	PALMINOPOLIS	PP12126013	PALMEIRAS	23/12/2020 04:10	23/12/2020 08:15	23/12/2020 04:10	23/12/2020 08:15	4,07	15	61,11	CHI
202012129391	JANDAIA	PP12126013	PALMEIRAS	23/12/2020 04:10	23/12/2020 08:15	23/12/2020 04:10	23/12/2020 08:15	4,07	29	118,14	CHI
202012129156	GOIAS	GS12071232	GOIAS	23/12/2020 04:11	23/12/2020 09:52	23/12/2020 04:11	23/12/2020 09:52	5,68	40	227,07	CHI
202012129158	PORANGATU	PO12028736	PORANGATU	23/12/2020 04:15	23/12/2020 08:13	23/12/2020 04:15	23/12/2020 08:13	3,97	4	15,86	CHI
202012129160	MORRINHOS	GT12273783	GOIATUBA S2	23/12/2020 04:19	23/12/2020 09:56	23/12/2020 04:19	23/12/2020 09:56	5,61	3	16,84	CHI
202012129160	GOIATUBA	GT12273783	GOIATUBA S2	23/12/2020 04:19	23/12/2020 09:56	23/12/2020 04:19	23/12/2020 09:56	5,61	18	101,07	CHI
202012130500	SILVANIA	SV12027332	BELA VISTA S2	23/12/2020 04:25	23/12/2020 11:29	23/12/2020 04:25	23/12/2020 11:29	7,06	11	77,62	CHI
202012129165	ANAPOLIS	7302272	NEROPOLIS S1	23/12/2020 04:26	23/12/2020 11:10	23/12/2020 04:26	23/12/2020 11:10	6,72	18	121,01	CHI
202012130029	BARRO ALTO	SJ12006465	GOIANESIA S1	23/12/2020 04:26	23/12/2020 10:37	23/12/2020 04:26	23/12/2020 10:37	6,18	14	86,47	CHI
202012130029	GOIANESIA	SJ12006465	GOIANESIA S1	23/12/2020 04:26	23/12/2020 10:37	23/12/2020 04:26	23/12/2020 10:37	6,18	20	123,52	CHI
202012129852	SAO MIGUEL DO ARAGUAIA	SM12321016	NOVA CRIXAS	23/12/2020 04:29	23/12/2020 17:52	23/12/2020 04:29	23/12/2020 17:52	13,37	7	93,61	CHI
202012131345	MORRO AGUDO DE GOIAS	RB12156092	RUBIATABA	23/12/2020 04:33	23/12/2020 12:00	23/12/2020 04:33	23/12/2020 12:00	7,44	10	74,38	CHI
202012129913	ITAUCU	IX12018278	INHUMAS S1	23/12/2020 04:35	23/12/2020 09:54	23/12/2020 04:35	23/12/2020 09:54	5,30	75	397,58	CHI
202012127633	AMORINOPOLIS	IV12390141	IPORA	23/12/2020 04:38	23/12/2020 11:04	23/12/2020 04:38	23/12/2020 11:04	6,43	6	38,59	CHI
202012127633	IVOLANDIA	IV12390141	IPORA	23/12/2020 04:38	23/12/2020 11:04	23/12/2020 04:38	23/12/2020 11:04	6,43	54	347,34	CHI
202012131113	LUZIANIA	OZ12186208	PIRES DO RIO S2	23/12/2020 04:38	23/12/2020 12:11	23/12/2020 04:38	23/12/2020 12:11	7,54	32	241,21	CHI
202012129173	IPORA	IR12091436	IPORA	23/12/2020 04:39	23/12/2020 07:57	23/12/2020 04:39	23/12/2020 07:57	3,30	18	59,36	CHI
202012129173	AMORINOPOLIS	IR12091436	IPORA	23/12/2020 04:39	23/12/2020 07:57	23/12/2020 04:39	23/12/2020 07:57	3,30	3	9,89	CHI
202012129174	GOIAS	GS12022123	ITAPURANGA	23/12/2020 04:39	23/12/2020 16:29	23/12/2020 04:39	23/12/2020 16:29	11,82	22	260,13	CHI

202012129174	HEITORAI	GS12022123	ITAPURANGA	23/12/2020 04:39	23/12/2020 16:29	23/12/2020 04:39	23/12/2020 16:29	11,82	6	70,94	CHI
202012129955	LUZIANIA	LZ12109848	VIANOPOLIS	23/12/2020 04:39	23/12/2020 12:34	23/12/2020 04:39	23/12/2020 12:34	7,90	23	181,80	CHI
202012129955	ORIZONA	LZ12109848	VIANOPOLIS	23/12/2020 04:39	23/12/2020 12:34	23/12/2020 04:39	23/12/2020 12:34	7,90	1	7,90	CHI
202012129178	CATALAO	OU12390253	CATALAO S1	23/12/2020 04:42	23/12/2020 08:18	23/12/2020 04:42	23/12/2020 08:18	3,59	8	28,72	CHI
202012129178	OUVIDOR	OU12390253	CATALAO S1	23/12/2020 04:42	23/12/2020 08:18	23/12/2020 04:42	23/12/2020 08:18	3,59	24	86,17	CHI
202012129879	ITAPURANGA	IK12220533	ITAPURANGA	23/12/2020 04:43	23/12/2020 13:24	23/12/2020 04:43	23/12/2020 13:24	8,68	26	225,76	CHI
202012129879	ITAGUARU	IK12220533	ITAPURANGA	23/12/2020 04:43	23/12/2020 13:24	23/12/2020 04:43	23/12/2020 13:24	8,68	1	8,68	CHI
202012130803	CATALAO	CT12250333	CATALAO S1	23/12/2020 04:44	23/12/2020 10:32	23/12/2020 04:44	23/12/2020 10:32	5,80	41	237,66	CHI
202012129377	BONOPOLIS	TA12263013	NOVO PLANALTO	23/12/2020 04:47	23/12/2020 10:48	23/12/2020 04:47	23/12/2020 10:48	6,00	31	186,02	CHI
202012130360	HIROLANDIA	HD12000269	CEPAIGO S1	23/12/2020 04:49	23/12/2020 11:55	23/12/2020 04:49	23/12/2020 11:55	7,09	121	857,82	CHI
202012129189	MARA ROSA	MQ12051834	MARA ROSA	23/12/2020 04:50	23/12/2020 11:28	23/12/2020 04:50	23/12/2020 11:28	6,62	14	92,72	CHI
202012129250	PARANAIGUARA	PC12119222	QUIRINOPOLIS	23/12/2020 04:53	23/12/2020 07:55	23/12/2020 04:53	23/12/2020 07:55	3,03	9	27,30	CHI
202012129273	GOIANIA	GN16415868	GOIANIA LESTE S3	23/12/2020 05:00	23/12/2020 14:23	23/12/2020 05:27	23/12/2020 06:43	1,26	156	196,95	CHI
202012129273	GOIANIA	GN16415868	GOIANIA LESTE S3	23/12/2020 05:00	23/12/2020 14:23	23/12/2020 05:27	23/12/2020 14:23	8,93	156	1393,60	CHI
202012130294	FORMOSA	FA12233641	SAO JOAO D ALIANCA	23/12/2020 05:02	23/12/2020 17:34	23/12/2020 05:02	23/12/2020 17:34	12,52	8	100,19	CHI
202012128979	APARECIDA DO RIO DOCE	7418901	CACHOEIRA ALTA	23/12/2020 05:03	27/12/2020 16:07	23/12/2020 05:03	23/12/2020 19:50	14,79	23	340,13	CHI
202012128979	APARECIDA DO RIO DOCE	7418901	CACHOEIRA ALTA	23/12/2020 05:03	27/12/2020 16:07	23/12/2020 05:03	23/12/2020 22:20	17,30	6	103,77	CHI
202012128979	APARECIDA DO RIO DOCE	7418901	CACHOEIRA ALTA	23/12/2020 05:03	27/12/2020 16:07	25/12/2020 00:47	25/12/2020 15:04	14,27	29	413,96	CHI
202012128979	APARECIDA DO RIO DOCE	7418901	CACHOEIRA ALTA	23/12/2020 05:03	27/12/2020 16:07	23/12/2020 05:03	26/12/2020 12:24	79,35	2	158,70	CHI
202012128979	APARECIDA DO RIO DOCE	AW12341109	CACHOEIRA ALTA	23/12/2020 05:03	27/12/2020 16:07	23/12/2020 05:03	26/12/2020 12:48	79,76	5	398,80	CHI
202012128979	APARECIDA DO RIO DOCE	7418901	CACHOEIRA ALTA	23/12/2020 05:03	27/12/2020 16:07	26/12/2020 13:23	26/12/2020 14:47	1,40	35	49,02	CHI
202012128979	APARECIDA DO RIO DOCE	7418901	CACHOEIRA ALTA	23/12/2020 05:03	27/12/2020 16:07	26/12/2020 13:35	26/12/2020 14:47	1,18	1	1,18	CHI
202012128979	APARECIDA DO RIO DOCE	AW12341113	CACHOEIRA ALTA	23/12/2020 05:03	27/12/2020 16:07	23/12/2020 05:03	26/12/2020 16:24	83,35	1	83,35	CHI
202012128979	JATAI	AW12341113	CACHOEIRA ALTA	23/12/2020 05:03	27/12/2020 16:07	23/12/2020 05:03	26/12/2020 16:24	83,35	6	500,13	CHI
202012128979	JATAI	AW12341111	CACHOEIRA ALTA	23/12/2020 05:03	27/12/2020 16:07	23/12/2020 05:03	26/12/2020 18:48	85,76	4	343,05	CHI
202012128979	APARECIDA DO RIO DOCE	AW12341111	CACHOEIRA ALTA	23/12/2020 05:03	27/12/2020 16:07	23/12/2020 05:03	26/12/2020 18:48	85,76	3	257,29	CHI
202012128979	JATAI	7418901	CACHOEIRA ALTA	23/12/2020 05:03	27/12/2020 16:07	23/12/2020 05:03	26/12/2020 18:58	85,92	22	1890,25	CHI
202012128979	JATAI	AW12341111	CACHOEIRA ALTA	23/12/2020 05:03	27/12/2020 16:07	23/12/2020 05:03	27/12/2020 16:07	107,07	4	428,29	CHI
202012129202	CALDAS NOVAS	CN12363790	SERRA DE CALDAS	23/12/2020 05:03	23/12/2020 07:16	23/12/2020 05:03	23/12/2020 07:16	2,22	72	159,48	CHI
202012129209	CAMPOS VERDES	VD12243626	SANTA TEREZINHA	23/12/2020 05:07	23/12/2020 13:32	23/12/2020 05:07	23/12/2020 13:32	8,40	20	168,09	CHI
202012129210	RUBIATABA	RB12028116	RUBIATABA	23/12/2020 05:08	23/12/2020 11:46	23/12/2020 05:08	23/12/2020 11:46	6,63	94	622,83	CHI
202012129215	IPAMERI	IP12266905	IPAMERI	23/12/2020 05:10	23/12/2020 08:04	23/12/2020 05:10	23/12/2020 08:04	2,89	4	11,55	CHI
202012129534	PONTALINA	PK12047065	PONTALINA	23/12/2020 05:10	23/12/2020 08:54	23/12/2020 05:10	23/12/2020 08:54	3,72	10	37,21	CHI
202012129216	FIRMINOPOLIS	900004150	FIRMINOPOLIS S1	23/12/2020 05:11	23/12/2020 08:36	23/12/2020 05:11	23/12/2020 08:36	3,41	1	3,41	CHI
202012129227	PALMEIRAS DE GOIAS	PL12016686	PALMEIRAS	23/12/2020 05:12	23/12/2020 07:07	23/12/2020 05:12	23/12/2020 07:07	1,90	11	20,93	CHI
202012130032	PIRES DO RIO	PR12000079RE	PIRES DO RIO S1	23/12/2020 05:13	23/12/2020 09:49	23/12/2020 05:13	23/12/2020 09:49	4,59	17	78,04	CHI
202012129222	MOSSAMEDES	MD12311080	ITABERA S2	23/12/2020 05:14	23/12/2020 08:22	23/12/2020 05:14	23/12/2020 08:22	3,12	15	46,87	CHI
202012131105	JUSSARA	IU12292910	JUSSARA	23/12/2020 05:15	24/12/2020 04:53	23/12/2020 05:15	24/12/2020 04:53	23,63	27	638,05	CHI
202012129456	BONOPOLIS	BX12202590	SAO MIGUEL DO ARAGUAIA	23/12/2020 05:16	23/12/2020 07:38	23/12/2020 05:16	23/12/2020 07:38	2,35	12	28,25	CHI
202012129802	BRAZABRANTES	BR12011938	NEROPOLIS S1	23/12/2020 05:16	23/12/2020 15:15	23/12/2020 13:20	23/12/2020 15:15	1,90	55	104,70	CHI
202012129802	NOVA VENEZA	BR12011938	NEROPOLIS S1	23/12/2020 05:16	23/12/2020 15:15	23/12/2020 13:20	23/12/2020 15:15	1,90	1	1,90	CHI
202012129232	PONTALINA	PK12025429	PONTALINA	23/12/2020 05:17	23/12/2020 10:07	23/12/2020 05:17	23/12/2020 10:07	4,82	7	33,73	CHI
202012129442	NOVA GLORIA	NG12328831	ITAPACI	23/12/2020 05:17	23/12/2020 07:20	23/12/2020 05:17	23/12/2020 07:20	2,04	4	8,14	CHI
202012129240	MOZARLANDIA	MZ10404285	MOZARLANDIA	23/12/2020 05:18	23/12/2020 20:57	23/12/2020 05:18	23/12/2020 08:11	2,89	62	179,27	CHI
202012129240	CRIXAS	MZ10404285	MOZARLANDIA	23/12/2020 05:18	23/12/2020 20:57	23/12/2020 05:18	23/12/2020 08:11	2,89	74	213,96	CHI
202012129240	NOVA CRIXAS	MZ10404285	MOZARLANDIA	23/12/2020 05:18	23/12/2020 20:57	23/12/2020 05:18	23/12/2020 08:11	2,89	27	78,07	CHI
202012129240	CRIXAS	MZ13022197	MOZARLANDIA	23/12/2020 05:18	23/12/2020 20:57	23/12/2020 05:18	23/12/2020 10:26	5,13	26	133,40	CHI
202012129240	MOZARLANDIA	MZ13022197	MOZARLANDIA	23/12/2020 05:18	23/12/2020 20:57	23/12/2020 05:18	23/12/2020 10:26	5,13	5	25,65	CHI
202012129240	MOZARLANDIA	6289503	MOZARLANDIA	23/12/2020 05:18	23/12/2020 20:57	23/12/2020 05:18	23/12/2020 11:05	5,80	14	81,15	CHI
202012129240	MOZARLANDIA	CX12063689LD	MOZARLANDIA	23/12/2020 05:18	23/12/2020 20:57	23/12/2020 11:06	23/12/2020 13:22	2,26	5	11,31	CHI
202012129240	CRIXAS	CX12063689LD	MOZARLANDIA	23/12/2020 05:18	23/12/2020 20:57	23/12/2020 11:06	23/12/2020 13:22	2,26	7	15,83	CHI

202012129240	CRIXAS	NA21232727	MOZARLANDIA	23/12/2020 05:18	23/12/2020 20:57	23/12/2020 15:27	23/12/2020 18:08	2,68	1	2,68	CHI
202012129240	MOZARLANDIA	CX12063689LD	MOZARLANDIA	23/12/2020 05:18	23/12/2020 20:57	23/12/2020 18:18	23/12/2020 20:57	2,65	5	13,27	CHI
202012129240	CRIXAS	CX12063689LD	MOZARLANDIA	23/12/2020 05:18	23/12/2020 20:57	23/12/2020 18:18	23/12/2020 20:57	2,65	7	18,57	CHI
202012129332	ANICUNS	AC12299011	FIRMINOPOLIS S2	23/12/2020 05:18	23/12/2020 07:08	23/12/2020 05:18	23/12/2020 07:08	1,82	10	18,20	CHI
202012131485	IPAMERI	IP12376252	CRISTALINA S2	23/12/2020 05:18	23/12/2020 17:30	23/12/2020 05:18	23/12/2020 17:30	12,20	20	243,93	CHI
202012129242	GOUVELANDIA	GB13370072	QUIRINOPOLIS	23/12/2020 05:22	23/12/2020 20:27	23/12/2020 09:36	23/12/2020 11:21	1,76	2040	3584,73	CHI
202012129242	QUIRINOPOLIS	GB13370072	QUIRINOPOLIS	23/12/2020 05:22	23/12/2020 20:27	23/12/2020 09:36	23/12/2020 11:21	1,76	89	156,39	CHI
202012129242	GOUVELANDIA	GB11395996	QUIRINOPOLIS	23/12/2020 05:22	23/12/2020 20:27	23/12/2020 11:02	23/12/2020 20:27	9,41	3	28,23	CHI
202012130068	SAO DOMINGOS	ND12218839	IACIARA S2	23/12/2020 05:22	23/12/2020 11:05	23/12/2020 05:22	23/12/2020 11:05	5,71	3	17,14	CHI
202012130068	IACIARA	ND12218839	IACIARA S2	23/12/2020 05:22	23/12/2020 11:05	23/12/2020 05:22	23/12/2020 11:05	5,71	24	137,11	CHI
202012129248	HEITORAI	HE12364776	ITAPURANGA	23/12/2020 05:23	23/12/2020 16:33	23/12/2020 05:23	23/12/2020 16:33	11,16	5	55,78	CHI
202012129372	MOIPIORA	MO12336568	IPORA	23/12/2020 05:24	23/12/2020 10:47	23/12/2020 05:24	23/12/2020 10:47	5,38	6	32,26	CHI
202012129372	IVOLANDIA	MO12336568	IPORA	23/12/2020 05:24	23/12/2020 10:47	23/12/2020 05:24	23/12/2020 10:47	5,38	6	32,26	CHI
202012129919	MORRO AGUDO DE GOIAS	MS12113246	ITAPURANGA	23/12/2020 05:24	23/12/2020 11:50	23/12/2020 05:24	23/12/2020 11:50	6,43	7	45,00	CHI
202012129919	FAINA	MS12113246	ITAPURANGA	23/12/2020 05:24	23/12/2020 11:50	23/12/2020 05:24	23/12/2020 11:50	6,43	8	51,43	CHI
202012129919	ARAGUAPAZ	MS12113246	ITAPURANGA	23/12/2020 05:24	23/12/2020 11:50	23/12/2020 05:24	23/12/2020 11:50	6,43	2	12,86	CHI
202012129263	FAINA	FC12321457	GOIAS	23/12/2020 05:25	23/12/2020 08:20	23/12/2020 05:25	23/12/2020 08:20	2,90	22	63,87	CHI
202012129961	ARAGUAPAZ	FC12071270	GOIAS	23/12/2020 05:25	23/12/2020 16:49	23/12/2020 05:25	23/12/2020 16:49	11,39	4	45,55	CHI
202012129961	FAINA	FC12071270	GOIAS	23/12/2020 05:25	23/12/2020 16:49	23/12/2020 05:25	23/12/2020 16:49	11,39	4	45,55	CHI
202012129261	INACIOLANDIA	ID12359397LD	QUIRINOPOLIS	23/12/2020 05:26	23/12/2020 09:10	23/12/2020 05:26	23/12/2020 09:10	3,72	57	212,02	CHI
202012129261	ITUMBIARA	ID12359397LD	QUIRINOPOLIS	23/12/2020 05:26	23/12/2020 09:10	23/12/2020 05:26	23/12/2020 09:10	3,72	3	11,16	CHI
202012129483	CACHOEIRA ALTA	CA12200630	CACHOEIRA ALTA	23/12/2020 05:26	23/12/2020 10:06	23/12/2020 05:26	23/12/2020 10:06	4,66	17	79,28	CHI
202012132224	VILA PROPICIO	GE12236840	GOIANESIA S2	23/12/2020 05:31	25/12/2020 04:51	23/12/2020 05:31	25/12/2020 04:51	47,34	28	1325,54	CHI
202012129274	ANICUNS	AC12158912	FIRMINOPOLIS S2	23/12/2020 05:32	23/12/2020 10:06	23/12/2020 05:32	23/12/2020 10:06	4,56	60	273,57	CHI
202012129276	GOIANIA	GN11210383	ATLANTICO S2	23/12/2020 05:32	23/12/2020 09:54	23/12/2020 05:32	23/12/2020 09:54	4,35	11	47,87	CHI
202012129277	BALIZA	BH11259279	CAIAPONIA	23/12/2020 05:34	23/12/2020 11:03	23/12/2020 05:34	23/12/2020 11:03	5,48	1	5,48	CHI
202012131608	NOVO BRASIL	NB12092962	MATRINCHA	23/12/2020 05:34	23/12/2020 23:08	23/12/2020 05:34	23/12/2020 23:08	17,56	5	87,81	CHI
202012131608	ITAPIRAPUA	NB12092962	MATRINCHA	23/12/2020 05:34	23/12/2020 23:08	23/12/2020 05:34	23/12/2020 23:08	17,56	1	17,56	CHI
202012131608	GOIAS	NB12092962	MATRINCHA	23/12/2020 05:34	23/12/2020 23:08	23/12/2020 05:34	23/12/2020 23:08	17,56	3	52,69	CHI
202012129281	SANTA TEREZINHA DE GOIAS	UP12294696	NOVA CRIXAS	23/12/2020 05:35	23/12/2020 15:03	23/12/2020 05:35	23/12/2020 15:03	9,48	1	9,48	CHI
202012129281	UIRAPURU	UP12294696	NOVA CRIXAS	23/12/2020 05:35	23/12/2020 15:03	23/12/2020 05:35	23/12/2020 15:03	9,48	4	37,90	CHI
202012129281	AMARALINA	UP12294696	NOVA CRIXAS	23/12/2020 05:35	23/12/2020 15:03	23/12/2020 05:35	23/12/2020 15:03	9,48	43	407,46	CHI
202012129281	MARA ROSA	UP12294696	NOVA CRIXAS	23/12/2020 05:35	23/12/2020 15:03	23/12/2020 05:35	23/12/2020 15:03	9,48	44	416,94	CHI
202012129286	CACHOEIRA DOURADA	00230414	BOM JESUS DE GOIAS	23/12/2020 05:37	24/12/2020 19:07	23/12/2020 05:37	23/12/2020 08:39	3,04	9	27,39	CHI
202012129286	BOM JESUS DE GOIAS	00230414	BOM JESUS DE GOIAS	23/12/2020 05:37	24/12/2020 19:07	23/12/2020 05:37	23/12/2020 08:39	3,04	5	15,22	CHI
202012129286	ITUMBIARA	00230414	BOM JESUS DE GOIAS	23/12/2020 05:37	24/12/2020 19:07	23/12/2020 05:37	23/12/2020 08:39	3,04	12	36,52	CHI
202012129286	ITUMBIARA	CD13304180	CACHOEIRA DOURADA	23/12/2020 05:37	24/12/2020 19:07	23/12/2020 09:46	23/12/2020 11:39	1,89	32	60,44	CHI
202012129286	CACHOEIRA DOURADA	CD13304180	CACHOEIRA DOURADA	23/12/2020 05:37	24/12/2020 19:07	23/12/2020 09:46	23/12/2020 11:39	1,89	60	113,33	CHI
202012129286	ITUMBIARA	CD13304180	CACHOEIRA DOURADA	23/12/2020 05:37	24/12/2020 19:07	23/12/2020 10:43	23/12/2020 11:39	0,94	6	5,65	CHI
202012129286	DISTRITO FEDERAL	CD13304180	CACHOEIRA DOURADA	23/12/2020 05:37	24/12/2020 19:07	23/12/2020 10:43	23/12/2020 11:39	0,94	1	0,94	CHI
202012129286	CACHOEIRA DOURADA	CD13304180	CACHOEIRA DOURADA	23/12/2020 05:37	24/12/2020 19:07	23/12/2020 10:43	23/12/2020 11:39	0,94	420	395,62	CHI
202012129286	INACIOLANDIA	CD13166472	CACHOEIRA DOURADA	23/12/2020 05:37	24/12/2020 19:07	23/12/2020 11:43	23/12/2020 11:46	0,06	102	6,32	CHI
202012129286	CACHOEIRA DOURADA	CD13166472	BOM JESUS DE GOIAS	23/12/2020 05:37	24/12/2020 19:07	23/12/2020 11:43	23/12/2020 11:46	0,06	4	0,25	CHI
202012129286	ITUMBIARA	CD13166472	CACHOEIRA DOURADA	23/12/2020 05:37	24/12/2020 19:07	23/12/2020 11:43	23/12/2020 11:46	0,06	12	0,74	CHI
202012129286	CACHOEIRA DOURADA	CD13166472	CACHOEIRA DOURADA	23/12/2020 05:37	24/12/2020 19:07	23/12/2020 11:43	23/12/2020 11:46	0,06	730	45,22	CHI
202012129286	CACHOEIRA DOURADA	CD16408285	CACHOEIRA DOURADA	23/12/2020 05:37	24/12/2020 19:07	23/12/2020 11:47	23/12/2020 12:47	1,00	398	397,01	CHI
202012129286	ITUMBIARA	CD16408285	CACHOEIRA DOURADA	23/12/2020 05:37	24/12/2020 19:07	23/12/2020 11:47	23/12/2020 12:47	1,00	32	31,92	CHI
202012129286	CACHOEIRA DOURADA	CD13273823	CACHOEIRA DOURADA	23/12/2020 05:37	24/12/2020 19:07	23/12/2020 11:47	23/12/2020 13:23	1,60	20	31,91	CHI
202012129286	CACHOEIRA DOURADA	CD13396181B	CACHOEIRA DOURADA	23/12/2020 05:37	24/12/2020 19:07	23/12/2020 11:47	23/12/2020 14:22	2,58	14	36,19	CHI
202012129286	ITUMBIARA	CD13396181B	CACHOEIRA DOURADA	23/12/2020 05:37	24/12/2020 19:07	23/12/2020 11:47	23/12/2020 14:22	2,58	6	15,51	CHI
202012129286	CACHOEIRA DOURADA	00280524	CACHOEIRA DOURADA	23/12/2020 05:37	24/12/2020 19:07	23/12/2020 14:03	23/12/2020 14:23	0,33	2770	918,72	CHI

202012129286	ITUMBIARA	00280524	CACHOEIRA DOURADA	23/12/2020 05:37	24/12/2020 19:07	23/12/2020 14:03	23/12/2020 14:23	0,33	50	16,58	CHI
202012129286	CACHOEIRA DOURADA	CD16409308	CACHOEIRA DOURADA	23/12/2020 05:37	24/12/2020 19:07	23/12/2020 13:42	23/12/2020 19:04	5,36	48	257,20	CHI
202012129286	DISTRITO FEDERAL	CD16409308	CACHOEIRA DOURADA	23/12/2020 05:37	24/12/2020 19:07	23/12/2020 13:42	23/12/2020 19:04	5,36	1	5,36	CHI
202012129286	CACHOEIRA DOURADA	CD13000013	CACHOEIRA DOURADA	23/12/2020 05:37	24/12/2020 19:07	23/12/2020 13:42	24/12/2020 00:24	10,71	20	214,14	CHI
202012129286	DISTRITO FEDERAL	CD13304180	CACHOEIRA DOURADA	23/12/2020 05:37	24/12/2020 19:07	24/12/2020 09:22	24/12/2020 09:40	0,30	1	0,30	CHI
202012129286	CACHOEIRA DOURADA	CD13304180	CACHOEIRA DOURADA	23/12/2020 05:37	24/12/2020 19:07	24/12/2020 09:22	24/12/2020 09:40	0,30	68	20,25	CHI
202012129286	CACHOEIRA DOURADA	CD13000006	CACHOEIRA DOURADA	23/12/2020 05:37	24/12/2020 19:07	23/12/2020 18:13	24/12/2020 16:05	21,88	8	175,06	CHI
202012129286	ITUMBIARA	CD13000006	CACHOEIRA DOURADA	23/12/2020 05:37	24/12/2020 19:07	23/12/2020 18:13	24/12/2020 16:05	21,88	2	43,76	CHI
202012129286	CACHOEIRA DOURADA	CD12032028	CACHOEIRA DOURADA	23/12/2020 05:37	24/12/2020 19:07	23/12/2020 18:13	24/12/2020 17:34	23,36	6	140,19	CHI
202012129286	ITUMBIARA	CD12032028	CACHOEIRA DOURADA	23/12/2020 05:37	24/12/2020 19:07	23/12/2020 18:13	24/12/2020 17:34	23,36	4	93,46	CHI
202012129286	CACHOEIRA DOURADA	CD16408285	CACHOEIRA DOURADA	23/12/2020 05:37	24/12/2020 19:07	24/12/2020 11:48	24/12/2020 18:49	7,02	337	2366,86	CHI
202012129286	CACHOEIRA DOURADA	CD16408285	CACHOEIRA DOURADA	23/12/2020 05:37	24/12/2020 19:07	24/12/2020 17:35	24/12/2020 18:49	1,25	61	76,01	CHI
202012129286	ITUMBIARA	CD16408285	CACHOEIRA DOURADA	23/12/2020 05:37	24/12/2020 19:07	24/12/2020 17:35	24/12/2020 18:49	1,25	32	39,88	CHI
202012129286	CACHOEIRA DOURADA	CD10396181	CACHOEIRA DOURADA	23/12/2020 05:37	24/12/2020 19:07	24/12/2020 18:53	24/12/2020 19:07	0,23	398	90,32	CHI
202012129286	ITUMBIARA	CD10396181	CACHOEIRA DOURADA	23/12/2020 05:37	24/12/2020 19:07	24/12/2020 18:53	24/12/2020 19:07	0,23	32	7,26	CHI
202012129302	SANTA FE DE GOIAS	04750214	MATRINCHA	23/12/2020 05:37	23/12/2020 09:10	23/12/2020 05:37	23/12/2020 09:10	3,53	12	42,41	CHI
202012129302	ITAPIRAPUA	04750214	MATRINCHA	23/12/2020 05:37	23/12/2020 09:10	23/12/2020 05:37	23/12/2020 09:10	3,53	436	1540,78	CHI
202012129302	JUSSARA	04750214	MATRINCHA	23/12/2020 05:37	23/12/2020 09:10	23/12/2020 05:37	23/12/2020 09:10	3,53	4	14,14	CHI
202012127569	GOIAS	GS12410738	GOIAS	23/12/2020 05:38	23/12/2020 11:36	23/12/2020 05:38	23/12/2020 11:36	5,96	37	220,44	CHI
202012130143	NOVO BRASIL	FN12250941	JUSSARA	23/12/2020 05:38	23/12/2020 12:30	23/12/2020 05:38	23/12/2020 12:30	6,86	2	13,71	CHI
202012130143	FAZENDA NOVA	FN12250941	JUSSARA	23/12/2020 05:38	23/12/2020 12:30	23/12/2020 05:38	23/12/2020 12:30	6,86	72	493,68	CHI
202012130081	VARJAO	AO32000285	GUAPO S2	23/12/2020 05:39	23/12/2020 13:59	23/12/2020 05:39	23/12/2020 13:59	8,34	68	566,93	CHI
202012130081	ARAGOIANIA	AO32000285	GUAPO S2	23/12/2020 05:39	23/12/2020 13:59	23/12/2020 05:39	23/12/2020 13:59	8,34	25	208,43	CHI
202012130081	HIDROLANDIA	AO32000285	GUAPO S2	23/12/2020 05:39	23/12/2020 13:59	23/12/2020 05:39	23/12/2020 13:59	8,34	110	917,09	CHI
202012130081	MAIRIPOTABA	AO32000285	GUAPO S2	23/12/2020 05:39	23/12/2020 13:59	23/12/2020 05:39	23/12/2020 13:59	8,34	2	16,67	CHI
202012130081	ARAGOIANIA	AO32000285	GUAPO S2	23/12/2020 05:39	23/12/2020 13:59	23/12/2020 10:22	23/12/2020 13:59	3,61	30	108,42	CHI
202012129295	GOIANIA	10031457043	GOYA S2	23/12/2020 05:40	23/12/2020 09:23	23/12/2020 05:40	23/12/2020 09:23	3,71	1	3,71	CHI
202012129538	JARAGUA	JA12029891	JARAGUA	23/12/2020 05:41	24/12/2020 11:40	23/12/2020 05:41	24/12/2020 11:40	29,97	4	119,88	CHI
202012130556	ANAPOLIS	AN12319783	ANAPOLIS UNIVERSITARIO S2	23/12/2020 05:42	23/12/2020 12:20	23/12/2020 05:42	23/12/2020 12:20	6,62	1	6,62	CHI
202012130556	PIRENOPOLIS	AN12319783	ANAPOLIS UNIVERSITARIO S2	23/12/2020 05:42	23/12/2020 12:20	23/12/2020 05:42	23/12/2020 12:20	6,62	18	119,22	CHI
202012129855	MONTA ALEGRE DE GOIAS	GH12156343RE	SAO DOMINGOS	23/12/2020 05:43	23/12/2020 10:01	23/12/2020 05:43	23/12/2020 10:01	4,30	15	64,45	CHI
202012129855	DIVINOPOLIS DE GOIAS	GH12156343RE	SAO DOMINGOS	23/12/2020 05:43	23/12/2020 10:01	23/12/2020 05:43	23/12/2020 10:01	4,30	125	537,12	CHI
202012129855	SAO DOMINGOS	GH12156343RE	SAO DOMINGOS	23/12/2020 05:43	23/12/2020 10:01	23/12/2020 05:43	23/12/2020 10:01	4,30	1	4,30	CHI
202012129471	JATAI	JT12244770	JATAI S1	23/12/2020 05:44	23/12/2020 07:37	23/12/2020 05:44	23/12/2020 07:37	1,87	13	24,34	CHI
202012129312	CIDADE OCIDENTAL	DH12090228	MARAJOARA	23/12/2020 05:46	23/12/2020 12:10	23/12/2020 05:46	23/12/2020 09:01	3,24	1	3,24	CHI
202012129312	CIDADE OCIDENTAL	DH12090228	MARAJOARA	23/12/2020 05:46	23/12/2020 12:10	23/12/2020 09:02	23/12/2020 12:10	3,13	3	9,39	CHI
202012130448	VILA PROPICIO	PV12073537	GOIANESIA S1	23/12/2020 05:46	23/12/2020 12:30	23/12/2020 05:46	23/12/2020 12:30	6,73	5	33,64	CHI
202012131181	ITUMBIARA	IT12222527	PARANAIBA	23/12/2020 05:48	23/12/2020 12:25	23/12/2020 05:48	23/12/2020 12:25	6,60	14	92,45	CHI
202012131493	VILA PROPICIO	ZN12402010RE	COCALZINHO	23/12/2020 05:48	23/12/2020 18:48	23/12/2020 05:48	23/12/2020 18:48	12,99	1	12,99	CHI
202012131493	COCALZINHO DE GOIAS	ZN12402010RE	COCALZINHO	23/12/2020 05:48	23/12/2020 18:48	23/12/2020 05:48	23/12/2020 18:48	12,99	158	2052,07	CHI
202012129318	MIMOSO DE GOIAS	MJ12295025	SAO JOAO D ALIANCA	23/12/2020 05:49	23/12/2020 10:33	23/12/2020 05:49	23/12/2020 10:33	4,73	6	28,37	CHI
202012129321	ALOANDIA	AD12108925	GOIATUBA S1	23/12/2020 05:49	23/12/2020 09:55	23/12/2020 05:49	23/12/2020 09:55	4,09	5	20,43	CHI
202012129321	MORRINHOS	AD12108925	GOIATUBA S1	23/12/2020 05:49	23/12/2020 09:55	23/12/2020 05:49	23/12/2020 09:55	4,09	2	8,17	CHI
202012129322	SILVANIA	SV21095145	VIANOPOLIS	23/12/2020 05:50	23/12/2020 10:12	23/12/2020 05:50	23/12/2020 10:12	4,36	1	4,36	CHI
202012129326	SENADOR CANEDO	GN12060626	GOIANIA LESTE S2	23/12/2020 05:51	23/12/2020 12:20	23/12/2020 05:51	23/12/2020 11:58	6,11	82	500,88	CHI
202012129326	SENADOR CANEDO	SW21080139	GOIANIA LESTE S2	23/12/2020 05:51	23/12/2020 12:20	23/12/2020 10:07	23/12/2020 12:06	1,99	1	1,99	CHI
202012129326	SENADOR CANEDO	SW21385664	GOIANIA LESTE S2	23/12/2020 05:51	23/12/2020 12:20	23/12/2020 09:54	23/12/2020 12:20	2,43	1	2,43	CHI
202012129336	JAUPACI	JP12193319	IPORA	23/12/2020 05:53	23/12/2020 11:04	23/12/2020 05:53	23/12/2020 11:04	5,17	4	20,68	CHI
202012129554	NOVA CRIXAS	NA12197190	NOVA CRIXAS	23/12/2020 05:53	23/12/2020 12:48	23/12/2020 05:53	23/12/2020 12:48	6,91	145	1002,51	CHI
202012130289	ORIZONA	OZ12000353LD	PIRES DO RIO S1	23/12/2020 05:54	23/12/2020 10:55	23/12/2020 05:54	23/12/2020 10:55	5,01	36	180,22	CHI
202012129347	TRINDADE	TR11129538	GOYA S2	23/12/2020 05:56	23/12/2020 08:23	23/12/2020 05:56	23/12/2020 08:23	2,45	70	171,34	CHI



202012129351	SAO MIGUEL DO PASSA QUATRO	20691510	VIANOPOLIS	23/12/2020 05:56	23/12/2020 11:52	23/12/2020 05:56	23/12/2020 11:52	5,92	5	29,62	CHI
202012130022	PIRACANJUBA	PJ12293360	PIRACANJUBA	23/12/2020 05:56	23/12/2020 10:02	23/12/2020 05:56	23/12/2020 10:02	4,09	12	49,11	CHI
202012130264	PIRACANJUBA	IT12273819	ITUMBIARA NOVA	23/12/2020 05:57	23/12/2020 16:54	23/12/2020 05:57	23/12/2020 16:54	10,94	1	10,94	CHI
202012130264	ITUMBIARA	IT12273819	ITUMBIARA NOVA	23/12/2020 05:57	23/12/2020 16:54	23/12/2020 05:57	23/12/2020 16:54	10,94	7	76,60	CHI
202012130264	ITUMBIARA	IT12273819	ITUMBIARA NOVA	23/12/2020 05:57	23/12/2020 16:54	23/12/2020 14:14	23/12/2020 16:54	2,67	11	29,39	CHI
202012130356	SAO JOAO DA PARAUNA	FR12000056	PARAUNA	23/12/2020 05:57	23/12/2020 10:57	23/12/2020 05:57	23/12/2020 10:57	4,99	45	224,41	CHI
202012130356	PALMINOPOLIS	FR12000056	FIRMINOPOLIS S1	23/12/2020 05:57	23/12/2020 10:57	23/12/2020 05:57	23/12/2020 10:57	4,99	1	4,99	CHI
202012130356	SAO JOAO DA PARAUNA	FR12000056	FIRMINOPOLIS S1	23/12/2020 05:57	23/12/2020 10:57	23/12/2020 05:57	23/12/2020 10:57	4,99	18	89,76	CHI
202012130356	FIRMINOPOLIS	FR12000056	FIRMINOPOLIS S1	23/12/2020 05:57	23/12/2020 10:57	23/12/2020 05:57	23/12/2020 10:57	4,99	29	144,62	CHI
202012129364	PIRES DO RIO	PR12409073	PIRES DO RIO S2	23/12/2020 05:58	23/12/2020 09:09	23/12/2020 05:58	23/12/2020 09:09	3,18	8	25,47	CHI
202012132218	DOVERLANDIA	DV12156199	PARQUE DAS EMAS	23/12/2020 05:58	24/12/2020 09:58	23/12/2020 05:58	24/12/2020 09:58	27,99	11	307,91	CHI
202012129367	CAMPOS VERDES	VD12257347	SANTA TEREZINHA	23/12/2020 05:59	23/12/2020 10:34	23/12/2020 05:59	23/12/2020 10:34	4,57	7	31,97	CHI
202012129373	MONTIVIDIU	MV12148369	MONTIVIDIU T	23/12/2020 06:00	23/12/2020 08:13	23/12/2020 06:00	23/12/2020 08:13	2,21	2	4,42	CHI
202012129375	MONTIVIDIU	MV11301683	MONTIVIDIU T	23/12/2020 06:00	23/12/2020 10:51	23/12/2020 06:00	23/12/2020 10:51	4,84	66	319,44	CHI
202012129969	JATAI	JT12184065	JATAI S2	23/12/2020 06:00	23/12/2020 22:31	23/12/2020 06:00	23/12/2020 21:18	15,29	6	91,75	CHI
202012129969	JATAI	JT12184065	JATAI S2	23/12/2020 06:00	23/12/2020 22:31	23/12/2020 19:14	23/12/2020 21:18	2,07	5	10,34	CHI
202012129969	JATAI	JT12184065	JATAI S2	23/12/2020 06:00	23/12/2020 22:31	23/12/2020 06:00	23/12/2020 22:31	16,51	2	33,03	CHI
202012131167	NIQUELANDIA	NQ12253797	URUACU	23/12/2020 06:00	23/12/2020 15:48	23/12/2020 06:00	23/12/2020 15:48	9,80	22	215,54	CHI
202012132361	CORUMBAIBA	CI12062859	VILA CORUMBA	23/12/2020 06:00	23/12/2020 12:39	23/12/2020 06:00	23/12/2020 12:39	6,65	20	132,94	CHI
202012129562	ITABERAI	IB12172694	ARACU	23/12/2020 06:01	23/12/2020 23:36	23/12/2020 06:01	23/12/2020 23:36	17,58	7	123,05	CHI
202012129562	ANICUNS	IB12172694	ARACU	23/12/2020 06:01	23/12/2020 23:36	23/12/2020 06:01	23/12/2020 23:36	17,58	1	17,58	CHI
202012129385	BURITINOPOLIS	BQ12344370RE	IACIARA S2	23/12/2020 06:02	23/12/2020 16:59	23/12/2020 06:02	23/12/2020 12:23	6,35	216	1371,24	CHI
202012129385	BURITINOPOLIS	BQ12344370RE	IACIARA S2	23/12/2020 06:02	23/12/2020 16:59	23/12/2020 06:02	23/12/2020 16:01	9,98	47	469,19	CHI
202012129385	MAMBAI	BQ12344370RE	IACIARA S2	23/12/2020 06:02	23/12/2020 16:59	23/12/2020 06:02	23/12/2020 16:35	10,56	1	10,56	CHI
202012129385	BURITINOPOLIS	BQ12344370RE	IACIARA S2	23/12/2020 06:02	23/12/2020 16:59	23/12/2020 06:02	23/12/2020 16:59	10,96	4	43,85	CHI
202012129484	ANAPOLIS	AN12258682	JUNDIAI S1	23/12/2020 06:02	23/12/2020 08:26	23/12/2020 06:02	23/12/2020 08:26	2,40	77	184,74	CHI
202012130089	GOIAS	GS12073885	MATRINCHA	23/12/2020 06:02	23/12/2020 11:08	23/12/2020 06:02	23/12/2020 11:08	5,09	15	76,37	CHI
202012130398	GOIANIA	GN12275486	GOYA S2	23/12/2020 06:02	23/12/2020 10:03	23/12/2020 06:02	23/12/2020 10:03	4,01	298	1194,40	CHI
202012130594	INDIARA	IY12158916	CEZARINA	23/12/2020 06:02	23/12/2020 11:32	23/12/2020 06:02	23/12/2020 11:32	5,49	2	10,98	CHI
202012131373	ARENOPOLIS	AY12156761	ARENOPOLIS	23/12/2020 06:02	23/12/2020 15:46	23/12/2020 06:02	23/12/2020 15:46	9,72	5	48,61	CHI
202012129399	SANTA TEREZA DE GOIAS	SE12182470	MARA ROSA	23/12/2020 06:03	23/12/2020 08:56	23/12/2020 06:03	23/12/2020 08:56	2,87	7	20,07	CHI
202012129401	SANTO ANTONIO DO DESCOBERTO	SN11249977	MARAJOARA	23/12/2020 06:04	23/12/2020 09:32	23/12/2020 06:04	23/12/2020 09:32	3,47	37	128,27	CHI
202012129868	PARAUNA	PU12079036	FIRMINOPOLIS S2	23/12/2020 06:04	23/12/2020 18:15	23/12/2020 06:04	23/12/2020 18:15	12,17	7	85,22	CHI
202012129410	CATALAO	CT12215511	CATALAO S1	23/12/2020 06:05	23/12/2020 08:02	23/12/2020 06:05	23/12/2020 08:02	1,94	9	17,48	CHI
202012131303	SAO FRANCISCO DE GOIAS	PG12230708	PETROLINA	23/12/2020 06:05	23/12/2020 17:21	23/12/2020 06:05	23/12/2020 17:21	11,26	13	146,43	CHI
202012131303	PETROLINA DE GOIAS	PG12230708	PETROLINA	23/12/2020 06:05	23/12/2020 17:21	23/12/2020 06:05	23/12/2020 17:21	11,26	6	67,58	CHI
202012129626	APARECIDA DE GOIANIA	AP12000049	CEPAIGO S1	23/12/2020 06:06	23/12/2020 09:07	23/12/2020 06:06	23/12/2020 09:07	3,00	39	117,14	CHI
202012129806	ITAPIRAPUA	IU12014848	MATRINCHA	23/12/2020 06:07	24/12/2020 12:48	23/12/2020 06:07	23/12/2020 10:40	4,54	2	9,09	CHI
202012129806	ITAPIRAPUA	IU12014848	MATRINCHA	23/12/2020 06:07	24/12/2020 12:48	23/12/2020 06:07	23/12/2020 12:40	6,55	46	301,35	CHI
202012129806	ITAPIRAPUA	IU12014848	MATRINCHA	23/12/2020 06:07	24/12/2020 12:48	23/12/2020 06:07	24/12/2020 12:48	30,69	10	306,88	CHI
202012130489	CAMPOS VERDES	VD12251079	SANTA TEREZINHA	23/12/2020 06:07	23/12/2020 14:09	23/12/2020 06:07	23/12/2020 14:09	8,03	3	24,09	CHI
202012130489	SANTA TEREZINHA DE GOIAS	VD12251079	SANTA TEREZINHA	23/12/2020 06:07	23/12/2020 14:09	23/12/2020 06:07	23/12/2020 14:09	8,03	3	24,09	CHI
202012131210	IPAMERI	IP12027061	URUTAI	23/12/2020 06:07	23/12/2020 11:22	23/12/2020 06:07	23/12/2020 11:22	5,24	27	141,61	CHI
202012131552	CAIAPONIA	CP12344723	MONTIVIDIU T	23/12/2020 06:07	23/12/2020 14:32	23/12/2020 06:07	23/12/2020 14:32	8,42	8	67,33	CHI
202012130013	DOVERLANDIA	DV12023480	CAIAPONIA	23/12/2020 06:08	23/12/2020 12:50	23/12/2020 06:08	23/12/2020 12:50	6,69	3	20,07	CHI
202012130013	PIRANHAS	DV12023480	CAIAPONIA	23/12/2020 06:08	23/12/2020 12:50	23/12/2020 06:08	23/12/2020 12:50	6,69	15	100,36	CHI
202012130013	CAIAPONIA	DV12023480	CAIAPONIA	23/12/2020 06:08	23/12/2020 12:50	23/12/2020 06:08	23/12/2020 12:50	6,69	49	327,85	CHI
202012129848	JANDAIA	JD12373324	PALMEIRAS	23/12/2020 06:09	23/12/2020 09:11	23/12/2020 06:09	23/12/2020 09:11	3,03	149	451,06	CHI
202012130584	SAO JOAO D ALIANCA	O2590206	ITUIQUIRA	23/12/2020 06:09	23/12/2020 11:04	23/12/2020 06:09	23/12/2020 11:04	4,91	230	1130,19	CHI
202012130584	FLORES DE GOIAS	O2590206	ITUIQUIRA	23/12/2020 06:09	23/12/2020 11:04	23/12/2020 06:09	23/12/2020 11:04	4,91	3	14,74	CHI
202012130584	FORMOSA	O2590206	ITUIQUIRA	23/12/2020 06:09	23/12/2020 11:04	23/12/2020 06:09	23/12/2020 11:04	4,91	557	2737,04	CHI

202012130584	VILA BOA	O2590206	ITUIQUIRA	23/12/2020 06:09	23/12/2020 11:04	23/12/2020 06:09	23/12/2020 11:04	4,91	4	19,66	CHI
202012131376	RIO VERDE	SH13271226	SANTA HELENA S1	23/12/2020 06:09	23/12/2020 17:44	23/12/2020 06:09	23/12/2020 17:44	11,58	7	81,08	CHI
202012131376	SANTA HELENA DE GOIAS	SH13271226	SANTA HELENA S1	23/12/2020 06:09	23/12/2020 17:44	23/12/2020 06:09	23/12/2020 17:44	11,58	49	567,56	CHI
202012131376	SANTO ANTONIO DA BARRA	SH13271226	SANTA HELENA S1	23/12/2020 06:09	23/12/2020 17:44	23/12/2020 06:09	23/12/2020 17:44	11,58	22	254,82	CHI
202012129462	MINEIROS	MY12303919RE	PARQUE DAS EMAS	23/12/2020 06:10	23/12/2020 11:47	23/12/2020 06:10	23/12/2020 11:47	5,62	20	112,31	CHI
202012129465	PIRACANJUBA	PJ12420392	CALDAS NOVAS S1	23/12/2020 06:10	23/12/2020 08:26	23/12/2020 06:10	23/12/2020 08:26	2,25	30	67,53	CHI
202012129519	ARAGUAPAZ	AZ12404560	GOIAS	23/12/2020 06:10	23/12/2020 09:28	23/12/2020 06:10	23/12/2020 09:28	3,29	4	13,17	CHI
202012130008	GOUVELANDIA	QI12000157	QUIRINOPOLIS	23/12/2020 06:10	23/12/2020 13:37	23/12/2020 06:10	23/12/2020 13:37	7,44	13	96,74	CHI
202012129469	BALIZA	BH12380942	BOM JARDIM	23/12/2020 06:11	23/12/2020 17:00	23/12/2020 06:11	23/12/2020 13:45	7,56	4	30,25	CHI
202012129469	BALIZA	BH12253652LD	BOM JARDIM	23/12/2020 06:11	23/12/2020 17:00	23/12/2020 06:11	23/12/2020 17:00	10,82	3	32,47	CHI
202012129740	CRISTALINA	IP12165527	CRISTALINA S1	23/12/2020 06:12	23/12/2020 09:38	23/12/2020 06:12	23/12/2020 09:38	3,42	15	51,28	CHI
202012129575	JUSSARA	JR12011813	BRITANIA	23/12/2020 06:13	23/12/2020 13:55	23/12/2020 06:13	23/12/2020 13:55	7,68	28	215,16	CHI
202012129973	FAINA	FC12057965	GOIAS	23/12/2020 06:13	23/12/2020 16:03	23/12/2020 06:13	23/12/2020 16:03	9,83	6	58,99	CHI
202012131770	PORTELANDIA	PW12303420	PARQUE DAS EMAS	23/12/2020 06:14	23/12/2020 13:30	23/12/2020 06:14	23/12/2020 13:30	7,27	14	101,76	CHI
202012129493	TROMBAS	TB12288306	PORANGATU	23/12/2020 06:15	23/12/2020 07:16	23/12/2020 06:15	23/12/2020 07:16	1,01	24	24,29	CHI
202012129494	RIO VERDE	RV12260697	RIO VERDE S1	23/12/2020 06:15	23/12/2020 12:46	23/12/2020 06:15	23/12/2020 12:46	6,51	4	26,04	CHI
202012129497	AMARALINA	MU12391981	MARA ROSA	23/12/2020 06:15	23/12/2020 17:08	23/12/2020 06:15	23/12/2020 17:08	10,88	5	54,41	CHI
202012129497	MUTUNOPOLIS	MU12391981	MARA ROSA	23/12/2020 06:15	23/12/2020 17:08	23/12/2020 06:15	23/12/2020 17:08	10,88	5	54,41	CHI
202012129728	SILVANIA	SV12012028	VIANOPOLIS	23/12/2020 06:15	23/12/2020 08:40	23/12/2020 06:15	23/12/2020 08:40	2,41	11	26,46	CHI
202012130546	SANTO ANTONIO DA BARRA	BZ12295804	ACREUNA	23/12/2020 06:15	23/12/2020 11:25	23/12/2020 06:15	23/12/2020 11:25	5,16	45	232,35	CHI
202012130546	RIO VERDE	BZ12295804	ACREUNA	23/12/2020 06:15	23/12/2020 11:25	23/12/2020 06:15	23/12/2020 11:25	5,16	25	129,08	CHI
202012130546	SANTA HELENA DE GOIAS	BZ12295804	ACREUNA	23/12/2020 06:15	23/12/2020 11:25	23/12/2020 06:15	23/12/2020 11:25	5,16	5	25,82	CHI
202012130681	NIQUELANDIA	NQ12375605	URUACU	23/12/2020 06:15	23/12/2020 10:48	23/12/2020 06:15	23/12/2020 10:48	4,54	44	199,56	CHI
202012129515	ARAGUAPAZ	AZ12057507	GOIAS	23/12/2020 06:17	23/12/2020 10:00	23/12/2020 06:17	23/12/2020 10:00	3,71	19	70,51	CHI
202012129524	GOIANIA	GN12288620	CARAJAS S1	23/12/2020 06:18	23/12/2020 08:58	23/12/2020 06:18	23/12/2020 08:00	1,70	789	1337,36	CHI
202012129524	GOIANIA	GN11190702	CARAJAS S1	23/12/2020 06:18	23/12/2020 08:58	23/12/2020 06:18	23/12/2020 08:58	2,67	137	365,87	CHI
202012129601	SANTA RITA DO NOVO DESTINO	BA12163300	BARRO ALTO	23/12/2020 06:18	23/12/2020 18:44	23/12/2020 06:18	23/12/2020 18:44	12,43	7	86,99	CHI
202012130402	BOM JARDIM DE GOIAS	BM12155744	BOM JARDIM	23/12/2020 06:18	24/12/2020 07:29	23/12/2020 06:18	24/12/2020 07:29	25,18	4	100,71	CHI
202012130709	ORIZONA	OZ12022882	PIRES DO RIO S2	23/12/2020 06:18	23/12/2020 10:28	23/12/2020 06:18	23/12/2020 10:28	4,16	20	83,14	CHI
202012131660	GOIANESIA	GE12000030	GOIANESIA S2	23/12/2020 06:18	23/12/2020 17:00	23/12/2020 06:18	23/12/2020 17:00	10,69	12	128,31	CHI
202012130466	SILVANIA	SV12202389	DAIA S2	23/12/2020 06:19	23/12/2020 10:43	23/12/2020 06:19	23/12/2020 10:43	4,40	9	39,59	CHI
202012130767	ALVORADA DO NORTE	FB12143258	IACIARA S2	23/12/2020 06:19	23/12/2020 12:44	23/12/2020 06:19	23/12/2020 12:44	6,41	30	192,33	CHI
202012130767	FLORES DE GOIAS	FB12143258	IACIARA S2	23/12/2020 06:19	23/12/2020 12:44	23/12/2020 06:19	23/12/2020 12:44	6,41	27	173,10	CHI
202012129543	CORUMBA DE GOIAS	AX12000154	CORUMBA	23/12/2020 06:20	23/12/2020 15:47	23/12/2020 06:20	23/12/2020 15:47	9,45	1	9,45	CHI
202012129543	ALEXANIA	AX12000154	CORUMBA	23/12/2020 06:20	23/12/2020 15:47	23/12/2020 06:20	23/12/2020 15:47	9,45	15	141,75	CHI
202012129580	PALESTINA DE GOIAS	PY12132875	PALESTINA	23/12/2020 06:20	23/12/2020 09:21	23/12/2020 06:20	23/12/2020 09:21	3,01	18	54,14	CHI
202012129624	IVOLANDIA	IV12037918	IPORA	23/12/2020 06:20	23/12/2020 08:14	23/12/2020 06:20	23/12/2020 08:14	1,89	11	20,81	CHI
202012130004	SANTA CRUZ DE GOIAS	BC12389804	PIRES DO RIO S2	23/12/2020 06:20	23/12/2020 10:14	23/12/2020 06:20	23/12/2020 10:14	3,89	22	85,66	CHI
202012129556	SAO MIGUEL DO ARAGUAIA	SM12245683	SAO MIGUEL DO ARAGUAIA	23/12/2020 06:21	23/12/2020 09:08	23/12/2020 06:21	23/12/2020 09:08	2,77	4	11,08	CHI
202012129557	GOIATUBA	GT12041277	GOIATUBA S2	23/12/2020 06:21	23/12/2020 16:31	23/12/2020 06:21	23/12/2020 16:31	10,15	3	30,46	CHI
202012131609	GOIAS	GS12058298	MATRINCHA	23/12/2020 06:22	23/12/2020 12:44	23/12/2020 06:22	23/12/2020 12:44	6,35	27	171,58	CHI
202012129574	PLANALTINA	PI12394160	SAO JOAO D ALIANCA	23/12/2020 06:23	23/12/2020 10:43	23/12/2020 06:23	23/12/2020 10:43	4,32	8	34,56	CHI
202012129583	RIO VERDE	RV12303494	MONTIVIDIU T	23/12/2020 06:24	23/12/2020 10:32	23/12/2020 06:24	23/12/2020 10:32	4,12	1	4,12	CHI
202012129596	PADRE BERNARDO	PB12382934	PADRE BERNARDO	23/12/2020 06:26	23/12/2020 12:03	23/12/2020 06:26	23/12/2020 12:03	5,61	4	22,45	CHI
202012131542	PIRANHAS	PH12334748	PIRANHAS	23/12/2020 06:26	23/12/2020 18:13	23/12/2020 06:26	23/12/2020 18:13	11,78	6	70,70	CHI
202012129609	HIDROLANDIA	HD12271821	INDEPENDENCIA S1	23/12/2020 06:27	23/12/2020 10:57	23/12/2020 06:27	23/12/2020 10:57	4,48	1	4,48	CHI
202012129613	ARAGUAPAZ	AZ12238878	MOZARLANDIA	23/12/2020 06:28	23/12/2020 10:25	23/12/2020 06:28	23/12/2020 10:25	3,94	13	51,28	CHI
202012129613	MOZARLANDIA	AZ12238878	MOZARLANDIA	23/12/2020 06:28	23/12/2020 10:25	23/12/2020 06:28	23/12/2020 10:25	3,94	1	3,94	CHI
202012129621	IPIRANGA DE GOIAS	RB12194284	RUBIATABA	23/12/2020 06:28	23/12/2020 09:27	23/12/2020 06:28	23/12/2020 09:27	2,97	3	8,91	CHI
202012129842	RIO VERDE	RV12123340	RIO VERDE S1	23/12/2020 06:28	23/12/2020 11:07	23/12/2020 06:28	23/12/2020 11:07	4,65	6	27,90	CHI
202012129692	DIORAMA	AY12390169	ARENOPOLIS	23/12/2020 06:29	23/12/2020 12:48	23/12/2020 06:29	23/12/2020 12:48	6,30	3	18,90	CHI

202012129692	ARENOPOLIS	AY12390169	ARENOPOLIS	23/12/2020 06:29	23/12/2020 12:48	23/12/2020 06:29	23/12/2020 12:48	6,30	22	138,62	CHI
202012129634	TRINDADE	40108144	TRINDADE	23/12/2020 06:30	23/12/2020 07:48	23/12/2020 06:30	23/12/2020 07:48	1,30	1	1,30	CHI
202012129641	FORMOSA	FA12195886LD	ITUIQUIRA	23/12/2020 06:30	23/12/2020 09:05	23/12/2020 06:30	23/12/2020 09:05	2,57	48	123,31	CHI
202012129642	NOVA AMERICA	NM12027453	RUBIATABA	23/12/2020 06:31	23/12/2020 09:41	23/12/2020 06:31	23/12/2020 09:41	3,16	9	28,46	CHI
202012129642	CRIXAS	NM12027453	RUBIATABA	23/12/2020 06:31	23/12/2020 09:41	23/12/2020 06:31	23/12/2020 09:41	3,16	6	18,97	CHI
202012129642	ITAPACI	NM12027453	RUBIATABA	23/12/2020 06:31	23/12/2020 09:41	23/12/2020 06:31	23/12/2020 09:41	3,16	2	6,32	CHI
202012132541	COCALZINHO DE GOIAS	PV12185533	COCALZINHO	23/12/2020 06:31	23/12/2020 20:34	23/12/2020 06:31	23/12/2020 20:34	14,04	1	14,04	CHI
202012132541	PIRENOPOLIS	PV12185533	COCALZINHO	23/12/2020 06:31	23/12/2020 20:34	23/12/2020 06:31	23/12/2020 20:34	14,04	20	280,79	CHI
202012129648	ARAGUAPAZ	AZ12404546	MOZARLANDIA	23/12/2020 06:32	23/12/2020 08:03	23/12/2020 06:32	23/12/2020 08:03	1,51	7	10,58	CHI
202012129653	JATAI	JT12196081RE	JATAI S3	23/12/2020 06:32	23/12/2020 15:58	23/12/2020 06:32	23/12/2020 15:58	9,42	7	65,96	CHI
202012129660	PILAR DE GOIAS	GG12181185	SANTA TEREZINHA	23/12/2020 06:33	23/12/2020 09:24	23/12/2020 06:33	23/12/2020 09:24	2,84	27	76,70	CHI
202012129661	IPAMERI	IP12195237	IPAMERI	23/12/2020 06:33	23/12/2020 22:12	23/12/2020 06:33	23/12/2020 20:34	14,02	5	70,10	CHI
202012129661	IPAMERI	IP12195237	IPAMERI	23/12/2020 06:33	23/12/2020 22:12	23/12/2020 06:33	23/12/2020 22:12	15,65	2	31,29	CHI
202012129702	PIRANHAS	PH12381017	PIRANHAS	23/12/2020 06:33	23/12/2020 09:50	23/12/2020 06:33	23/12/2020 09:50	3,27	12	39,27	CHI
202012129665	TRINDADE	TR11000011	TRINDADE	23/12/2020 06:34	23/12/2020 12:12	23/12/2020 11:18	23/12/2020 12:12	0,90	92	82,80	CHI
202012129691	BONOPOLIS	BX12136924	SAO MIGUEL DO ARAGUAIA	23/12/2020 06:37	23/12/2020 17:05	23/12/2020 06:37	23/12/2020 17:05	10,46	5	52,29	CHI
202012129693	TRINDADE	TR12005135	TRINDADE	23/12/2020 06:37	23/12/2020 10:55	23/12/2020 06:37	23/12/2020 10:55	4,29	4	17,16	CHI
202012129914	CRISTALINA	KR12163117	CRISTALINA S1	23/12/2020 06:37	23/12/2020 11:59	23/12/2020 06:37	23/12/2020 11:59	5,36	7	37,53	CHI
202012130066	QUIRINOPOLIS	QI12013481	QUIRINOPOLIS	23/12/2020 06:38	23/12/2020 09:40	23/12/2020 06:38	23/12/2020 09:40	3,03	4	12,12	CHI
202012130716	ALOANDIA	JV12123830	GOIATUBA S1	23/12/2020 06:38	23/12/2020 12:46	23/12/2020 06:38	23/12/2020 12:46	6,12	2	12,24	CHI
202012130716	JOVIANIA	JV12123830	GOIATUBA S1	23/12/2020 06:38	23/12/2020 12:46	23/12/2020 06:38	23/12/2020 12:46	6,12	6	36,73	CHI
202012131180	MARA ROSA	MQ12146959	MARA ROSA	23/12/2020 06:38	23/12/2020 15:00	23/12/2020 06:38	23/12/2020 15:00	8,37	11	92,05	CHI
202012131180	NOVA IGUACU DE GOIAS	MQ12146959	MARA ROSA	23/12/2020 06:38	23/12/2020 15:00	23/12/2020 06:38	23/12/2020 15:00	8,37	12	100,41	CHI
202012129707	SANTO ANTONIO DO DESCOBERTO	SN12290826	PACAEMBU S1	23/12/2020 06:39	23/12/2020 11:11	23/12/2020 06:39	23/12/2020 11:11	4,53	17	76,93	CHI
202012129707	NOVO GAMA	SN12290826	PACAEMBU S1	23/12/2020 06:39	23/12/2020 11:11	23/12/2020 06:39	23/12/2020 11:11	4,53	4	18,10	CHI
202012133385	LEOPOLDO DE BULHOES	LB13383433	DAIA S2	23/12/2020 06:39	24/12/2020 18:54	24/12/2020 15:10	24/12/2020 18:38	3,47	1	3,47	CHI
202012133385	SILVANIA	LB13383433	DAIA S2	23/12/2020 06:39	24/12/2020 18:54	24/12/2020 15:10	24/12/2020 18:38	3,47	2	6,94	CHI
202012133385	SILVANIA	LB12267902	DAIA S2	23/12/2020 06:39	24/12/2020 18:54	23/12/2020 06:39	24/12/2020 18:44	36,09	1	36,09	CHI
202012133385	GAMELEIRA DE GOIAS	LB12267953	DAIA S2	23/12/2020 06:39	24/12/2020 18:54	23/12/2020 06:39	24/12/2020 18:54	36,26	11	398,85	CHI
202012133385	SILVANIA	LB12267953	DAIA S2	23/12/2020 06:39	24/12/2020 18:54	23/12/2020 06:39	24/12/2020 18:54	36,26	24	870,21	CHI
202012130049	JATAI	JT12000160LD	JATAI S2	23/12/2020 06:40	23/12/2020 09:38	23/12/2020 06:40	23/12/2020 09:38	2,95	36	106,34	CHI
202012129721	IPAMERI	IP12404739	IPAMERI	23/12/2020 06:41	23/12/2020 21:11	23/12/2020 06:41	23/12/2020 21:11	14,49	2	28,97	CHI
202012129721	CALDAS NOVAS	IP12404739	IPAMERI	23/12/2020 06:41	23/12/2020 21:11	23/12/2020 06:41	23/12/2020 21:11	14,49	2	28,97	CHI
202012129976	JARAGUA	JA12059976	JARAGUA	23/12/2020 06:42	23/12/2020 12:33	23/12/2020 06:42	23/12/2020 12:33	5,85	2	11,69	CHI
202012129976	PIRENOPOLIS	JA12059976	JARAGUA	23/12/2020 06:42	23/12/2020 12:33	23/12/2020 06:42	23/12/2020 12:33	5,85	97	567,05	CHI
202012129738	CRISTALINA	KR12383034	CRISTALINA S1	23/12/2020 06:44	23/12/2020 14:06	23/12/2020 06:44	23/12/2020 14:06	7,36	3	22,08	CHI
202012131712	IPAMERI	IP12167965	IPAMERI	23/12/2020 06:44	24/12/2020 13:22	23/12/2020 06:44	24/12/2020 13:22	30,64	1	30,64	CHI
202012131712	CORUMBAIBA	IP12167965	IPAMERI	23/12/2020 06:44	24/12/2020 13:22	23/12/2020 06:44	24/12/2020 13:22	30,64	2	61,28	CHI
202012129747	BURITI ALEGRE	BG12000110	ITUMBIARA VELHA S2	23/12/2020 06:45	23/12/2020 11:28	23/12/2020 06:45	23/12/2020 11:28	4,70	7	32,92	CHI
202012129750	SENADOR CANEDO	SW12078053	CEPAIGO S1	23/12/2020 06:46	23/12/2020 14:33	23/12/2020 06:46	23/12/2020 14:33	7,78	2	15,57	CHI
202012129751	NOVA CRIXAS	NA12407826	NOVA CRIXAS	23/12/2020 06:46	23/12/2020 11:33	23/12/2020 06:46	23/12/2020 11:33	4,78	7	33,47	CHI
202012129760	MUNDO NOVO DE GOIAS	MH12391967	NOVA CRIXAS	23/12/2020 06:47	23/12/2020 08:51	23/12/2020 06:47	23/12/2020 08:51	2,07	8	16,52	CHI
202012129818	FAINA	FC12038664	GOIAS	23/12/2020 06:47	23/12/2020 10:53	23/12/2020 06:47	23/12/2020 10:53	4,10	10	40,96	CHI
202012132159	CORUMBAIBA	CI12060036	VILA CORUMBA	23/12/2020 06:47	23/12/2020 13:46	23/12/2020 06:47	23/12/2020 13:46	6,97	6	41,85	CHI
202012129768	GOIATUBA	JV12222364	GOIATUBA S1	23/12/2020 06:48	23/12/2020 10:58	23/12/2020 06:48	23/12/2020 10:58	4,17	2	8,33	CHI
202012129771	PORANGATU	PO12192255	PORANGATU	23/12/2020 06:48	23/12/2020 16:43	23/12/2020 06:48	23/12/2020 16:43	9,91	60	594,90	CHI
202012129917	PORANGATU	MU12391982	MARA ROSA	23/12/2020 06:48	23/12/2020 09:37	23/12/2020 06:48	23/12/2020 09:37	2,81	17	47,70	CHI
202012131540	PIRANHAS	PH12038595	PIRANHAS	23/12/2020 06:48	23/12/2020 17:27	23/12/2020 06:48	23/12/2020 17:27	10,65	13	138,44	CHI
202012129776	URUACU	UR11056768	URUACU	23/12/2020 06:49	23/12/2020 08:10	23/12/2020 06:49	23/12/2020 08:10	1,34	207	278,13	CHI
202012129781	IPAMERI	IP12112779	IPAMERI	23/12/2020 06:49	23/12/2020 11:44	23/12/2020 06:49	23/12/2020 11:44	4,90	28	137,22	CHI
202012129782	ACREUNA	EU21350869	ACREUNA	23/12/2020 06:50	23/12/2020 13:42	23/12/2020 06:50	23/12/2020 13:42	6,86	1	6,86	CHI

202012129785	APORE	AE12209702	ITAJA S1	23/12/2020 06:50	23/12/2020 11:07	23/12/2020 06:50	23/12/2020 11:07	4,27	2	8,54	CHI
202012130415	CAVALCANTE	CJ12047981	FLORES DE GOIAS	23/12/2020 06:50	23/12/2020 09:08	23/12/2020 06:50	23/12/2020 09:08	2,29	1175	2686,18	CHI
202012131626	NIQUELANDIA	NQ12070622	URUACU	23/12/2020 06:50	23/12/2020 18:55	23/12/2020 06:50	23/12/2020 18:55	12,07	137	1653,55	CHI
202012132289	MARA ROSA	LC12050751	MARA ROSA	23/12/2020 06:50	23/12/2020 13:18	23/12/2020 06:50	23/12/2020 13:18	6,45	5	32,26	CHI
202012132289	AMARALINA	LC12050751	MARA ROSA	23/12/2020 06:50	23/12/2020 13:18	23/12/2020 06:50	23/12/2020 13:18	6,45	12	77,42	CHI
202012129793	CRISTALINA	KR12348546RE	PAMPLONA	23/12/2020 06:51	23/12/2020 13:11	23/12/2020 06:51	23/12/2020 13:11	6,33	22	139,28	CHI
202012130923	PADRE BERNARDO	PB12284769	PADRE BERNARDO	23/12/2020 06:51	23/12/2020 12:56	23/12/2020 06:51	23/12/2020 12:56	6,07	69	419,04	CHI
202012130779	APARECIDA DO RIO DOCE	JT12081473	JATAI S1	23/12/2020 06:52	23/12/2020 14:29	23/12/2020 06:52	23/12/2020 14:29	7,60	10	76,05	CHI
202012129820	HIDROLANDIA	HD12200271	CEPAIGO S2	23/12/2020 06:53	23/12/2020 16:27	23/12/2020 06:53	23/12/2020 16:27	9,55	15	143,30	CHI
202012130501	PIRACANJUBA	PJ12000096	PIRACANJUBA	23/12/2020 06:53	23/12/2020 11:10	23/12/2020 06:53	23/12/2020 11:10	4,28	34	145,37	CHI
202012129840	PORTELANDIA	MY13205281	PARQUE DAS EMAS	23/12/2020 06:55	23/12/2020 11:37	23/12/2020 11:06	23/12/2020 11:37	0,52	11	5,69	CHI
202012129840	MINEIROS	MY13205281	PARQUE DAS EMAS	23/12/2020 06:55	23/12/2020 11:37	23/12/2020 11:06	23/12/2020 11:37	0,52	64	33,10	CHI
202012129840	MONTIVIDIU	MY13205281	PARQUE DAS EMAS	23/12/2020 06:55	23/12/2020 11:37	23/12/2020 11:06	23/12/2020 11:37	0,52	1	0,52	CHI
202012129885	CAMPO LIMPO	AN12357374	NEROPOLIS S1	23/12/2020 06:56	23/12/2020 12:11	23/12/2020 06:56	23/12/2020 12:11	5,24	14	73,37	CHI
202012129975	IACIARA	IA12302910	IACIARA S1	23/12/2020 06:56	23/12/2020 14:56	23/12/2020 06:56	23/12/2020 10:42	3,77	2	7,53	CHI
202012129975	IACIARA	IA12302910	IACIARA S1	23/12/2020 06:56	23/12/2020 14:56	23/12/2020 06:56	23/12/2020 13:43	6,77	6	40,61	CHI
202012129975	IACIARA	IA12302910	IACIARA S1	23/12/2020 06:56	23/12/2020 14:56	23/12/2020 06:56	23/12/2020 14:34	7,62	2	15,25	CHI
202012129975	IACIARA	IA12302910	IACIARA S1	23/12/2020 06:56	23/12/2020 14:56	23/12/2020 06:56	23/12/2020 14:56	7,99	2	15,98	CHI
202012129869	ANAPOLIS	AN12382121	DAIA S1	23/12/2020 06:59	23/12/2020 08:25	23/12/2020 06:59	23/12/2020 08:25	1,42	6	8,51	CHI
202012131201	SANTA ROSA DE GOIAS	SR12000048	INHUMAS S1	23/12/2020 06:59	23/12/2020 16:59	23/12/2020 06:59	23/12/2020 16:59	10,01	5	50,05	CHI
202012129876	NOVA CRIXAS	NA12227101	NOVA CRIXAS	23/12/2020 07:00	23/12/2020 14:50	23/12/2020 07:00	23/12/2020 14:50	7,82	25	195,45	CHI
202012129878	SERRANOPOLIS	SX12166103	JATAI S1	23/12/2020 07:00	23/12/2020 19:59	23/12/2020 07:00	23/12/2020 19:59	12,97	5	64,84	CHI
202012129881	GOIANIA	GN12001730	FERROVIARIO S2	23/12/2020 07:01	23/12/2020 08:44	23/12/2020 07:01	23/12/2020 08:44	1,71	10	17,12	CHI
202012130496	IACIARA	IA12195949	IACIARA S1	23/12/2020 07:01	23/12/2020 15:49	23/12/2020 07:01	23/12/2020 15:49	8,79	19	166,92	CHI
202012129893	GOIANESIA	GE12000108	GOIANESIA S1	23/12/2020 07:02	24/12/2020 17:21	23/12/2020 07:02	24/12/2020 17:21	34,30	1	34,30	CHI
202012129893	SANTA RITA DO NOVO DESTINO	GE12000108	GOIANESIA S1	23/12/2020 07:02	24/12/2020 17:21	23/12/2020 07:02	24/12/2020 17:21	34,30	1	34,30	CHI
202012129894	PONTALINA	VI12335578	VICENTINOPOLIS	23/12/2020 07:02	23/12/2020 21:03	23/12/2020 07:02	23/12/2020 21:03	14,00	3	42,01	CHI
202012129894	VICENTINOPOLIS	VI12335578	VICENTINOPOLIS	23/12/2020 07:02	23/12/2020 21:03	23/12/2020 07:02	23/12/2020 21:03	14,00	10	140,03	CHI
202012129899	ANAPOLIS	AN21295574	DAIA S1	23/12/2020 07:03	23/12/2020 15:56	23/12/2020 07:03	23/12/2020 15:56	8,88	1	8,88	CHI
202012130839	APORE	AE12061471	ITAJA S1	23/12/2020 07:04	23/12/2020 13:41	23/12/2020 07:04	23/12/2020 13:41	6,61	7	46,29	CHI
202012129918	MINEIROS	MY12336355	PARQUE DAS EMAS	23/12/2020 07:05	23/12/2020 10:45	23/12/2020 07:05	23/12/2020 10:45	3,66	3	10,99	CHI
202012129926	BOM JARDIM DE GOIAS	PH12317697	PIRANHAS	23/12/2020 07:06	23/12/2020 14:16	23/12/2020 07:06	23/12/2020 14:16	7,16	2	14,31	CHI
202012129926	PIRANHAS	PH12317697	PIRANHAS	23/12/2020 07:06	23/12/2020 14:16	23/12/2020 07:06	23/12/2020 14:16	7,16	2	14,31	CHI
202012129935	VICENTINOPOLIS	VI12218178	VICENTINOPOLIS	23/12/2020 07:07	23/12/2020 22:08	23/12/2020 07:07	23/12/2020 22:08	15,01	5	75,03	CHI
202012130074	SAO LUIS DE MONTES BELOS	TV32098063	FIRMINOPOLIS S1	23/12/2020 07:07	23/12/2020 09:29	23/12/2020 07:07	23/12/2020 09:29	2,36	4	9,46	CHI
202012130074	FIRMINOPOLIS	TV32098063	FIRMINOPOLIS S1	23/12/2020 07:07	23/12/2020 09:29	23/12/2020 07:07	23/12/2020 09:29	2,36	2	4,73	CHI
202012130114	PALMINOPOLIS	PP12233526	PALMEIRAS	23/12/2020 07:07	23/12/2020 09:26	23/12/2020 07:07	23/12/2020 09:26	2,31	31	71,63	CHI
202012132040	ITUMBARA	IT12305492	PARANAIBA	23/12/2020 07:07	23/12/2020 18:52	23/12/2020 07:07	23/12/2020 18:52	11,74	3	35,21	CHI
202012129947	CRISTALINA	KR12277177	CRISTALINA S2	23/12/2020 07:09	23/12/2020 12:09	23/12/2020 07:09	23/12/2020 12:09	5,00	1	5,00	CHI
202012129951	COLINAS DO SUL	TI12170026	MINACU	23/12/2020 07:10	23/12/2020 11:55	23/12/2020 07:10	23/12/2020 11:55	4,75	7	33,23	CHI
202012129953	FAINA	FC12211092	GOIAS	23/12/2020 07:10	24/12/2020 02:06	23/12/2020 07:10	24/12/2020 02:06	18,94	23	435,65	CHI
202012129957	APORE	AE12327006	ITAJA S1	23/12/2020 07:10	23/12/2020 10:27	23/12/2020 07:10	23/12/2020 10:27	3,27	1	3,27	CHI
202012129959	ARUANA	AK12408617	BRITANIA	23/12/2020 07:10	23/12/2020 09:14	23/12/2020 07:10	23/12/2020 09:14	2,05	1	2,05	CHI
202012129962	BELA VISTA DE GOIAS	BV12360000	BELA VISTA S2	23/12/2020 07:10	23/12/2020 09:48	23/12/2020 07:10	23/12/2020 09:48	2,62	2	5,24	CHI
202012130811	RIO VERDE	RV12000192	RIO VERDE S1	23/12/2020 07:10	23/12/2020 10:25	23/12/2020 07:10	23/12/2020 10:25	3,24	23	74,44	CHI
202012128986	MAIRIPOTABA	MI12011393	PONTALINA	23/12/2020 07:11	23/12/2020 09:27	23/12/2020 07:11	23/12/2020 09:27	2,27	34	77,05	CHI
202012129967	CORUMBAIBA	CI12280791	VILA CORUMBA	23/12/2020 07:11	23/12/2020 16:59	23/12/2020 07:11	23/12/2020 16:59	9,80	21	205,71	CHI
202012129982	CALDAS NOVAS	CN12202907	VILA CORUMBA	23/12/2020 07:12	23/12/2020 08:04	23/12/2020 07:12	23/12/2020 08:04	0,87	2	1,73	CHI
202012129982	MARZAGAO	CN12202907	VILA CORUMBA	23/12/2020 07:12	23/12/2020 08:04	23/12/2020 07:12	23/12/2020 08:04	0,87	37	32,07	CHI
202012130135	SILVANIA	SV12389456	VIANOPOLIS	23/12/2020 07:12	23/12/2020 10:51	23/12/2020 07:12	23/12/2020 10:51	3,64	72	262,44	CHI
202012129981	LUZIANIA	LZ21068395	MARAJOARA	23/12/2020 07:13	23/12/2020 12:51	23/12/2020 07:13	23/12/2020 12:31	5,30	1	5,30	CHI

202012129981	LUZIANIA	LZ12230287	MARAJOARA	23/12/2020 07:13	23/12/2020 12:51	23/12/2020 12:31	23/12/2020 12:51	0,33	10	3,32	CHI
202012129990	SAO JOAO D ALIANCA	JL12364061	SAO JOAO D ALIANCA	23/12/2020 07:14	23/12/2020 10:03	23/12/2020 07:14	23/12/2020 10:03	2,81	2	5,63	CHI
202012129998	RUBIATABA	RB12132695	RUBIATABA	23/12/2020 07:14	23/12/2020 18:10	23/12/2020 07:14	23/12/2020 12:07	4,89	55	268,72	CHI
202012129998	RUBIATABA	RB11132696	RUBIATABA	23/12/2020 07:14	23/12/2020 18:10	23/12/2020 07:14	23/12/2020 18:10	10,92	54	589,66	CHI
202012129999	SANTA FE DE GOIAS	RN21292748	BRITANIA	23/12/2020 07:14	23/12/2020 15:44	23/12/2020 07:14	23/12/2020 15:44	8,48	1	8,48	CHI
202012130001	URUACU	UR12003395	URUACU	23/12/2020 07:15	23/12/2020 10:04	23/12/2020 07:15	23/12/2020 10:04	2,81	8	22,48	CHI
202012130175	FAZENDA NOVA	FN11371911	IPORA	23/12/2020 07:15	23/12/2020 10:28	23/12/2020 07:15	23/12/2020 10:28	3,20	1	3,20	CHI
202012130937	MONTE ALEGRE DE GOIAS	MA12236692	SAO DOMINGOS	23/12/2020 07:15	23/12/2020 14:29	23/12/2020 07:15	23/12/2020 14:29	7,22	5	36,12	CHI
202012130007	MUTUNOPOLIS	PO12084869	PORANGATU	23/12/2020 07:16	23/12/2020 09:02	23/12/2020 07:16	23/12/2020 09:02	1,76	4	7,05	CHI
202012130007	PORANGATU	PO12084869	PORANGATU	23/12/2020 07:16	23/12/2020 09:02	23/12/2020 07:16	23/12/2020 09:02	1,76	3	5,29	CHI
202012124656	OURO VERDE DE GOIAS	PG12297814	PETROLINA	23/12/2020 07:17	23/12/2020 13:35	23/12/2020 07:17	23/12/2020 13:35	6,29	24	151,04	CHI
202012124656	PETROLINA DE GOIAS	PG12297814	PETROLINA	23/12/2020 07:17	23/12/2020 13:35	23/12/2020 07:17	23/12/2020 13:35	6,29	14	88,11	CHI
202012130015	PALMEIRAS DE GOIAS	PL12067650	ANICUNS	23/12/2020 07:17	23/12/2020 08:14	23/12/2020 07:17	23/12/2020 08:14	0,94	3	2,83	CHI
202012130027	RIO VERDE	630523836	RIO VERDE S2	23/12/2020 07:18	23/12/2020 19:23	23/12/2020 07:18	23/12/2020 19:23	12,07	1	12,07	CHI
202012130478	CROMINIA	MI12120719	PONTALINA	23/12/2020 07:18	23/12/2020 09:41	23/12/2020 07:18	23/12/2020 09:41	2,38	5	11,88	CHI
202012130478	MAIRIPOTABA	MI12120719	PONTALINA	23/12/2020 07:18	23/12/2020 09:41	23/12/2020 07:18	23/12/2020 09:41	2,38	1	2,38	CHI
202012130109	RIO VERDE	RV16407143	RIO VERDE S1	23/12/2020 07:20	23/12/2020 11:37	23/12/2020 07:20	23/12/2020 07:25	0,09	1112	95,14	CHI
202012130109	RIO VERDE	RV16407143	RIO VERDE S1	23/12/2020 07:20	23/12/2020 11:37	23/12/2020 07:20	23/12/2020 11:37	4,28	1024	4386,99	CHI
202012130046	CAMPINORTE	CR10404187	MARA ROSA	23/12/2020 07:22	23/12/2020 11:47	23/12/2020 10:02	23/12/2020 11:47	1,74	197	343,44	CHI
202012130046	URUACU	CR10404187	MARA ROSA	23/12/2020 07:22	23/12/2020 11:47	23/12/2020 10:02	23/12/2020 11:47	1,74	414	721,74	CHI
202012130046	CAMPINACU	CR10404187	MARA ROSA	23/12/2020 07:22	23/12/2020 11:47	23/12/2020 10:02	23/12/2020 11:47	1,74	303	528,23	CHI
202012130057	AGUAS LINDAS DE GOIAS	LA12112919	AGUAS LINDAS DE GOIAS S2	23/12/2020 07:23	23/12/2020 10:34	23/12/2020 07:23	23/12/2020 10:34	3,17	2	6,34	CHI
202012130116	CORUMBA DE GOIAS	CB12377445	CORUMBA	23/12/2020 07:23	24/12/2020 12:00	23/12/2020 07:23	24/12/2020 12:00	28,60	21	600,70	CHI
202012130980	MINEIROS	MY12274100RE	PARQUE DAS EMAS	23/12/2020 07:23	23/12/2020 10:00	23/12/2020 07:23	23/12/2020 10:00	2,61	16	41,69	CHI
202012132348	GOIANDIRA	GD12377061	CATALAO S1	23/12/2020 07:23	23/12/2020 14:01	23/12/2020 07:23	23/12/2020 14:01	6,62	14	92,65	CHI
202012130070	GOIANDIRA	CT12231642	CATALAO S1	23/12/2020 07:24	23/12/2020 11:09	23/12/2020 07:24	23/12/2020 11:09	3,74	3	11,22	CHI
202012130071	SAO MIGUEL DO ARAGUAIA	SM12031421	SAO MIGUEL DO ARAGUAIA	23/12/2020 07:24	23/12/2020 13:22	23/12/2020 07:24	23/12/2020 13:22	5,95	16	95,27	CHI
202012130287	SENADOR CANEDO	SW12366166	CEPAIGO S2	23/12/2020 07:24	23/12/2020 19:00	23/12/2020 07:24	23/12/2020 16:56	9,53	177	1685,97	CHI
202012130287	SENADOR CANEDO	SW12079060	CEPAIGO S2	23/12/2020 07:24	23/12/2020 19:00	23/12/2020 07:24	23/12/2020 19:00	11,59	114	1321,48	CHI
202012131753	VILA PROPICIO	NP12228397	GOIANESIA S1	23/12/2020 07:24	23/12/2020 18:05	23/12/2020 07:24	23/12/2020 18:05	10,67	3	32,01	CHI
202012130086	HEITORAI	IC12065281	ITABERAI S1	23/12/2020 07:25	23/12/2020 13:12	23/12/2020 07:25	23/12/2020 13:12	5,77	5	28,85	CHI
202012130086	ITAGUARU	IC12065281	ITABERAI S1	23/12/2020 07:25	23/12/2020 13:12	23/12/2020 07:25	23/12/2020 13:12	5,77	3	17,31	CHI
202012130136	CORUMBAIBA	CI12110198	VILA CORUMBA	23/12/2020 07:25	23/12/2020 12:15	23/12/2020 07:25	23/12/2020 12:15	4,83	8	38,60	CHI
202012130791	JATAI	JT12226486	JATAI S1	23/12/2020 07:27	23/12/2020 10:09	23/12/2020 07:27	23/12/2020 10:09	2,69	28	75,41	CHI
202012131827	MARA ROSA	MQ12380741	SANTA TEREZINHA	23/12/2020 07:27	23/12/2020 15:09	23/12/2020 07:27	23/12/2020 15:09	7,70	12	92,37	CHI
202012130103	GOIANESIA	GE12384157	GOIANESIA S2	23/12/2020 07:28	24/12/2020 03:19	23/12/2020 07:28	24/12/2020 03:19	19,84	6	119,03	CHI
202012130451	CAMPO LIMPO	OV12033148	NEROPOLIS S1	23/12/2020 07:28	23/12/2020 12:49	23/12/2020 07:28	23/12/2020 12:49	5,33	3	16,00	CHI
202012130451	OURO VERDE DE GOIAS	OV12033148	NEROPOLIS S1	23/12/2020 07:28	23/12/2020 12:49	23/12/2020 07:28	23/12/2020 12:49	5,33	4	21,34	CHI
202012130117	MORRINHOS	MR12105036	MORRINHOS	23/12/2020 07:29	23/12/2020 11:03	23/12/2020 07:29	23/12/2020 11:03	3,56	16	56,92	CHI
202012130122	FAINA	FC12311200	MATRINCHA	23/12/2020 07:29	23/12/2020 10:10	23/12/2020 07:29	23/12/2020 10:10	2,67	3	8,01	CHI
202012130131	ADELANDIA	MD12304614	ANICUNS	23/12/2020 07:29	23/12/2020 10:39	23/12/2020 07:29	23/12/2020 10:39	3,16	2	6,33	CHI
202012130131	MOSSAMEDES	MD12304614	ANICUNS	23/12/2020 07:29	23/12/2020 10:39	23/12/2020 07:29	23/12/2020 10:39	3,16	7	22,15	CHI
202012130656	CRIXAS	CX12321941	SERRA DO OURO	23/12/2020 07:29	23/12/2020 15:17	23/12/2020 07:29	23/12/2020 15:17	7,79	18	140,17	CHI
202012130656	NOVA CRIXAS	CX12321941	SERRA DO OURO	23/12/2020 07:29	23/12/2020 15:17	23/12/2020 07:29	23/12/2020 15:17	7,79	5	38,93	CHI
202012130798	GOIANDIRA	GD12075612	CATALAO S1	23/12/2020 07:29	23/12/2020 10:37	23/12/2020 07:29	23/12/2020 10:37	3,13	9	28,15	CHI
202012130124	ABADIA DE GOIAS	GN12057790	CARAJAS S1	23/12/2020 07:30	23/12/2020 11:34	23/12/2020 07:30	23/12/2020 11:34	4,06	7	28,42	CHI
202012132287	FLORES DE GOIAS	FB12045259	IACIARA S2	23/12/2020 07:30	23/12/2020 12:54	23/12/2020 07:30	23/12/2020 12:54	5,39	427	2303,43	CHI
202012132287	SITIO D ABADIA	FB12045259	IACIARA S2	23/12/2020 07:30	23/12/2020 12:54	23/12/2020 07:30	23/12/2020 12:54	5,39	120	647,33	CHI
202012130132	JARAGUA	JA12297431	JARAGUA	23/12/2020 07:31	24/12/2020 13:31	23/12/2020 07:31	24/12/2020 13:31	29,98	52	1559,19	CHI
202012130144	MINEIROS	MY12210139	PARQUE DAS EMAS	23/12/2020 07:32	23/12/2020 11:47	23/12/2020 07:32	23/12/2020 11:47	4,24	1	4,24	CHI
202012130168	IPORA	AY12139436	ARENOPOLIS	23/12/2020 07:32	23/12/2020 11:53	23/12/2020 07:32	23/12/2020 11:53	4,36	10	43,57	CHI

202012130168	ARENOPOLIS	AY12139436	ARENOPOLIS	23/12/2020 07:32	23/12/2020 11:53	23/12/2020 07:32	23/12/2020 11:53	4,36	16	69,72	CHI
202012130639	NIQUELANDIA	NY12235115	URUACU	23/12/2020 07:35	23/12/2020 11:03	23/12/2020 07:35	23/12/2020 11:03	3,46	27	93,52	CHI
202012131188	JUSSARA	BT12274297	BRITANIA	23/12/2020 07:35	23/12/2020 15:41	23/12/2020 07:35	23/12/2020 15:41	8,10	37	299,70	CHI
202012130255	CAMPESTRE DE GOIAS	GC12005189	TRINDADE	23/12/2020 07:37	23/12/2020 09:55	23/12/2020 07:37	23/12/2020 09:55	2,29	17	38,94	CHI
202012130215	BURITI ALEGRE	BG12000130	ITUMBIARA VELHA S2	23/12/2020 07:38	23/12/2020 10:01	23/12/2020 07:38	23/12/2020 10:01	2,38	1	2,38	CHI
202012130217	MINEIROS	MY12260468	PARQUE DAS EMAS	23/12/2020 07:38	23/12/2020 19:45	23/12/2020 07:38	23/12/2020 19:45	12,11	4	48,44	CHI
202012131299	PIRANHAS	PH12381052	PIRANHAS	23/12/2020 07:38	24/12/2020 08:46	23/12/2020 07:38	24/12/2020 08:46	25,13	7	175,91	CHI
202012131339	CALDAS NOVAS	CN12122123	SERRA DE CALDAS	23/12/2020 07:39	23/12/2020 11:50	23/12/2020 07:39	23/12/2020 11:50	4,17	5	20,87	CHI
202012130230	MAURILANDIA	ML12303334	RIO DOS BOIS	23/12/2020 07:40	23/12/2020 13:51	23/12/2020 07:40	23/12/2020 13:51	6,18	14	86,56	CHI
202012130230	RIO VERDE	ML12303334	RIO DOS BOIS	23/12/2020 07:40	23/12/2020 13:51	23/12/2020 07:40	23/12/2020 13:51	6,18	2	12,37	CHI
202012130238	HEITORAI	HE12019118	ITAPURANGA	23/12/2020 07:40	23/12/2020 17:49	23/12/2020 07:40	23/12/2020 17:49	10,15	1	10,15	CHI
202012131883	CRISTALINA	KR12168476	CRISTALINA S2	23/12/2020 07:41	23/12/2020 12:08	23/12/2020 07:41	23/12/2020 12:08	4,44	29	128,86	CHI
202012132662	TURVELANDIA	EU12026747	RIO DOS BOIS	23/12/2020 07:42	23/12/2020 14:32	23/12/2020 07:42	23/12/2020 14:32	6,83	13	88,78	CHI
202012132662	ACREUNA	EU12026747	RIO DOS BOIS	23/12/2020 07:42	23/12/2020 14:32	23/12/2020 07:42	23/12/2020 14:32	6,83	11	75,12	CHI
202012130261	MARA ROSA	ET12136395	MARA ROSA	23/12/2020 07:43	23/12/2020 10:24	23/12/2020 07:43	23/12/2020 10:24	2,68	9	24,12	CHI
202012130261	ESTRELA DO NORTE	ET12136395	MARA ROSA	23/12/2020 07:43	23/12/2020 10:24	23/12/2020 07:43	23/12/2020 10:24	2,68	11	29,48	CHI
202012130946	MINEIROS	MY12324344	PARQUE DAS EMAS	23/12/2020 07:43	25/12/2020 09:02	23/12/2020 07:43	25/12/2020 09:02	49,32	7	345,22	CHI
202012130277	GOIAS	GS12014796	MATRINCHA	23/12/2020 07:45	23/12/2020 12:09	23/12/2020 07:45	23/12/2020 12:09	4,40	95	417,92	CHI
202012130298	GOIAS	GS12250574	GOIAS	23/12/2020 07:48	23/12/2020 10:26	23/12/2020 07:48	23/12/2020 10:26	2,63	8	21,05	CHI
202012130357	PLANALTINA	PI12085617RE	PLANALTINA	23/12/2020 07:48	23/12/2020 09:32	23/12/2020 07:48	23/12/2020 09:32	1,72	416	715,06	CHI
202012131008	AMARALINA	LC12216163	MARA ROSA	23/12/2020 07:48	23/12/2020 12:05	23/12/2020 07:48	23/12/2020 12:05	4,28	5	21,42	CHI
202012130306	PIRACANJUBA	PJ12233807	ROCHEDO	23/12/2020 07:49	23/12/2020 10:56	23/12/2020 07:49	23/12/2020 10:56	3,11	8	24,89	CHI
202012130326	PARAUNA	PU12295865	ACREUNA	23/12/2020 07:51	23/12/2020 11:41	23/12/2020 07:51	23/12/2020 11:41	3,83	2	7,65	CHI
202012130328	JARAGUA	JA12297835	JARAGUA	23/12/2020 07:51	23/12/2020 15:00	23/12/2020 07:51	23/12/2020 15:00	7,15	17	121,52	CHI
202012130508	RIO QUENTE	RQ12050875	VILA CORUMBA	23/12/2020 07:51	23/12/2020 10:32	23/12/2020 07:51	23/12/2020 10:32	2,67	14	37,37	CHI
202012132448	SILVANIA	SV21161718	DAIA S2	23/12/2020 07:51	23/12/2020 15:24	23/12/2020 07:51	23/12/2020 15:24	7,56	1	7,56	CHI
202012133539	CORUMBAIBA	CI12027790	VILA CORUMBA	23/12/2020 07:52	24/12/2020 10:19	23/12/2020 07:52	24/12/2020 10:19	26,45	1	26,45	CHI
202012130341	PARAUNA	PU12279674	ACREUNA	23/12/2020 07:53	23/12/2020 12:36	23/12/2020 07:53	23/12/2020 12:36	4,71	3	14,13	CHI
202012130346	OUVIDOR	OU12061240	CATALAO S1	23/12/2020 07:53	23/12/2020 17:04	23/12/2020 07:53	23/12/2020 17:04	9,17	1	9,17	CHI
202012130347	APORE	IJ12054739	ITAJA S2	23/12/2020 07:53	24/12/2020 07:10	23/12/2020 07:53	24/12/2020 07:10	23,27	1	23,27	CHI
202012130425	SANTA HELENA DE GOIAS	SH10404081	IPEGUARI	23/12/2020 07:56	24/12/2020 00:30	23/12/2020 07:56	23/12/2020 10:10	2,23	46	102,58	CHI
202012130425	TURVELANDIA	SH10404081	IPEGUARI	23/12/2020 07:56	24/12/2020 00:30	23/12/2020 07:56	23/12/2020 10:10	2,23	12	26,76	CHI
202012130425	SANTA HELENA DE GOIAS	SH12295822LD	IPEGUARI	23/12/2020 07:56	24/12/2020 00:30	23/12/2020 07:56	23/12/2020 11:34	3,63	31	112,68	CHI
202012130425	SANTA HELENA DE GOIAS	SH10404081	IPEGUARI	23/12/2020 07:56	24/12/2020 00:30	23/12/2020 11:43	23/12/2020 12:02	0,32	46	14,58	CHI
202012130425	TURVELANDIA	SH10404081	IPEGUARI	23/12/2020 07:56	24/12/2020 00:30	23/12/2020 11:43	23/12/2020 12:02	0,32	12	3,80	CHI
202012130425	SANTA HELENA DE GOIAS	SH12295822LD	IPEGUARI	23/12/2020 07:56	24/12/2020 00:30	23/12/2020 11:43	23/12/2020 14:40	2,95	13	38,30	CHI
202012130425	SANTA HELENA DE GOIAS	SH12295846LD	IPEGUARI	23/12/2020 07:56	24/12/2020 00:30	23/12/2020 07:56	23/12/2020 15:24	7,45	65	484,48	CHI
202012130425	SANTA HELENA DE GOIAS	SH12295844	IPEGUARI	23/12/2020 07:56	24/12/2020 00:30	23/12/2020 11:43	23/12/2020 19:15	7,53	11	82,81	CHI
202012130425	SANTA HELENA DE GOIAS	SH12394803	IPEGUARI	23/12/2020 07:56	24/12/2020 00:30	23/12/2020 19:16	23/12/2020 21:28	2,21	16	35,31	CHI
202012130425	TURVELANDIA	SH12394803	IPEGUARI	23/12/2020 07:56	24/12/2020 00:30	23/12/2020 19:16	23/12/2020 21:28	2,21	5	11,03	CHI
202012130425	SANTA HELENA DE GOIAS	SH10404081	IPEGUARI	23/12/2020 07:56	24/12/2020 00:30	23/12/2020 20:10	23/12/2020 21:28	1,30	30	39,04	CHI
202012130425	TURVELANDIA	SH10404081	IPEGUARI	23/12/2020 07:56	24/12/2020 00:30	23/12/2020 20:10	23/12/2020 21:28	1,30	7	9,11	CHI
202012130425	SANTA HELENA DE GOIAS	SH12295822LD	IPEGUARI	23/12/2020 07:56	24/12/2020 00:30	23/12/2020 11:43	23/12/2020 22:26	10,71	7	74,97	CHI
202012130425	SANTA HELENA DE GOIAS	SH12394803	IPEGUARI	23/12/2020 07:56	24/12/2020 00:30	23/12/2020 19:16	23/12/2020 22:26	3,16	8	25,30	CHI
202012130425	SANTA HELENA DE GOIAS	SH12295822LD	IPEGUARI	23/12/2020 07:56	24/12/2020 00:30	23/12/2020 20:10	23/12/2020 22:26	2,26	7	15,80	CHI
202012130425	SANTA HELENA DE GOIAS	SH12394803	IPEGUARI	23/12/2020 07:56	24/12/2020 00:30	23/12/2020 19:16	24/12/2020 00:30	5,23	74	387,12	CHI
202012130425	SANTA HELENA DE GOIAS	SH12295822LD	IPEGUARI	23/12/2020 07:56	24/12/2020 00:30	24/12/2020 00:17	24/12/2020 00:30	0,21	22	4,71	CHI
202012130439	CALDAS NOVAS	CN12363794	SERRA DE CALDAS	23/12/2020 07:56	23/12/2020 13:15	23/12/2020 07:56	23/12/2020 13:15	5,31	4	21,26	CHI
202012130370	PONTALINA	AD12108919	GOIATUBA S1	23/12/2020 07:57	23/12/2020 15:05	23/12/2020 07:57	23/12/2020 15:05	7,12	3	21,37	CHI
202012130370	ALOANDIA	AD12108919	GOIATUBA S1	23/12/2020 07:57	23/12/2020 15:05	23/12/2020 07:57	23/12/2020 15:05	7,12	11	78,36	CHI
202012130549	LEOPOLDO DE BULHOES	LB12000624	DAIA S1	23/12/2020 07:57	23/12/2020 11:37	23/12/2020 07:57	23/12/2020 11:37	3,65	33	120,47	CHI

202012130374	RIO QUENTE	RQ12263103	VILA CORUMBA	23/12/2020 07:58	23/12/2020 11:54	23/12/2020 07:58	23/12/2020 11:54	3,93	2	7,86	CHI
202012130744	CACU	CC12191705	CACHOEIRA ALTA	23/12/2020 07:58	23/12/2020 11:01	23/12/2020 07:58	23/12/2020 11:01	3,04	47	142,71	CHI
202012130394	CRISTALINA	KR12163676RE	PAMPLONA	23/12/2020 08:01	23/12/2020 21:29	23/12/2020 08:01	23/12/2020 21:29	13,46	2	26,93	CHI
202012130397	DOVERLANDIA	DV12259474	CAIAPONIA	23/12/2020 08:02	24/12/2020 04:56	23/12/2020 08:02	24/12/2020 04:56	20,90	38	794,03	CHI
202012130399	CAMPINORTE	CR21247876	MARA ROSA	23/12/2020 08:02	23/12/2020 13:36	23/12/2020 08:02	23/12/2020 13:36	5,58	16	89,22	CHI
202012130602	SANTA TEREZINHA DE GOIAS	SG12202098RE	SANTA TEREZINHA	23/12/2020 08:02	23/12/2020 12:08	23/12/2020 08:02	23/12/2020 12:08	4,09	143	584,27	CHI
202012130602	UIRAPURU	SG12202098RE	SANTA TEREZINHA	23/12/2020 08:02	23/12/2020 12:08	23/12/2020 08:02	23/12/2020 12:08	4,09	61	249,24	CHI
202012130602	CAMPOS VERDES	SG12202098RE	SANTA TEREZINHA	23/12/2020 08:02	23/12/2020 12:08	23/12/2020 08:02	23/12/2020 12:08	4,09	40	163,43	CHI
202012130871	FAINA	FC12307334	GOIAS	23/12/2020 08:02	23/12/2020 22:02	23/12/2020 08:02	23/12/2020 22:02	13,99	5	69,93	CHI
202012131032	SILVANIA	SV12060971	VIANOPOLIS	23/12/2020 08:02	23/12/2020 15:42	23/12/2020 08:02	23/12/2020 15:42	7,66	4	30,62	CHI
202012130412	ITABERAI	IB12078567	ITABERAI S1	23/12/2020 08:03	23/12/2020 17:10	23/12/2020 08:03	23/12/2020 17:10	9,10	17	154,76	CHI
202012130412	ITAUCU	IB12078567	ITABERAI S1	23/12/2020 08:03	23/12/2020 17:10	23/12/2020 08:03	23/12/2020 17:10	9,10	2	18,21	CHI
202012133795	JARAGUA	JA12297949	JARAGUA	23/12/2020 08:03	25/12/2020 13:04	23/12/2020 08:03	24/12/2020 19:15	35,20	12	422,37	CHI
202012133795	JARAGUA	JA12297949	JARAGUA	23/12/2020 08:03	25/12/2020 13:04	24/12/2020 08:20	24/12/2020 19:15	10,92	15	163,75	CHI
202012133795	JARAGUA	JA12297949	JARAGUA	23/12/2020 08:03	25/12/2020 13:04	23/12/2020 08:03	25/12/2020 13:04	53,02	1	53,02	CHI
202012130816	GOUVELANDIA	GB12303132	QUIRINOPOLIS	23/12/2020 08:04	23/12/2020 10:48	23/12/2020 08:04	23/12/2020 10:48	2,72	53	144,28	CHI
202012130874	CORUMBA DE GOIAS	CB12382347	CORUMBA	23/12/2020 08:04	24/12/2020 15:02	23/12/2020 08:04	24/12/2020 15:02	30,97	4	123,87	CHI
202012131305	IPAMERI	IP12013258	IPAMERI	23/12/2020 08:04	23/12/2020 13:31	23/12/2020 08:04	23/12/2020 13:31	5,43	6	32,60	CHI
202012130487	QUIRINOPOLIS	QI32017987	QUIRINOPOLIS	23/12/2020 08:05	23/12/2020 10:19	23/12/2020 08:05	23/12/2020 10:19	2,23	11	24,53	CHI
202012131133	PORANGATU	PO12241996	PORANGATU	23/12/2020 08:05	23/12/2020 11:44	23/12/2020 08:05	23/12/2020 11:44	3,64	82	298,50	CHI
202012132668	EDEALINA	EA12039620RE	VICENTINOPOLIS	23/12/2020 08:06	24/12/2020 08:02	23/12/2020 08:06	24/12/2020 08:02	23,93	4	95,72	CHI
202012133769	DIORAMA	DI12188303	ARENOPOLIS	23/12/2020 08:06	24/12/2020 02:54	23/12/2020 08:06	24/12/2020 02:54	18,79	28	526,17	CHI
202012133769	MONTES CLAROS DE GOIAS	DI12188303	ARENOPOLIS	23/12/2020 08:06	24/12/2020 02:54	23/12/2020 08:06	24/12/2020 02:54	18,79	1	18,79	CHI
202012130463	APARECIDA DE GOIANIA	AP12200151	CEPAIGO S1	23/12/2020 08:07	23/12/2020 15:02	23/12/2020 08:07	23/12/2020 15:02	6,91	14	96,69	CHI
202012133404	APORE	AE12000051	ITAJA S1	23/12/2020 08:07	23/12/2020 15:32	23/12/2020 08:07	23/12/2020 15:32	7,42	7	51,91	CHI
202012131259	APORE	AE12038902	ITAJA S1	23/12/2020 08:08	23/12/2020 12:02	23/12/2020 08:08	23/12/2020 12:02	3,90	7	27,30	CHI
202012131298	CORUMBA DE GOIAS	ZN12201365	COCALZINHO	23/12/2020 08:09	24/12/2020 18:03	23/12/2020 08:09	24/12/2020 18:03	33,91	2	67,81	CHI
202012131298	CORUMBA DE GOIAS	ZN12201365	COCALZINHO	23/12/2020 08:09	24/12/2020 18:03	24/12/2020 10:10	24/12/2020 18:03	7,90	13	102,66	CHI
202012131298	COCALZINHO DE GOIAS	ZN12201365	COCALZINHO	23/12/2020 08:09	24/12/2020 18:03	24/12/2020 10:10	24/12/2020 18:03	7,90	3	23,69	CHI
202012130498	CATALAO	CT12013670	CATALAO S1	23/12/2020 08:10	23/12/2020 14:33	23/12/2020 08:10	23/12/2020 14:33	6,37	4	25,49	CHI
202012130514	VICENTINOPOLIS	VI12218200	VICENTINOPOLIS	23/12/2020 08:11	23/12/2020 13:02	23/12/2020 08:11	23/12/2020 13:02	4,84	3	14,51	CHI
202012130536	TRINDADE	TR12027284	TRINDADE	23/12/2020 08:13	23/12/2020 10:53	23/12/2020 08:13	23/12/2020 10:53	2,68	11	29,43	CHI
202012130547	RIO VERDE	RV12200052	MONTIVIDIU T	23/12/2020 08:14	23/12/2020 11:20	23/12/2020 08:14	23/12/2020 11:20	3,09	2	6,19	CHI
202012130550	RIO VERDE	RV11000046	RIO VERDE S1	23/12/2020 08:14	23/12/2020 10:02	23/12/2020 08:14	23/12/2020 10:02	1,79	107	191,68	CHI
202012131651	PIRACANJUBA	MR12000241	MORRINHOS	23/12/2020 08:14	23/12/2020 12:04	23/12/2020 08:14	23/12/2020 12:04	3,82	6	22,95	CHI
202012130569	GOIANIA	GN11000332	GOIANIA LESTE S1	23/12/2020 08:16	23/12/2020 11:39	23/12/2020 08:16	23/12/2020 11:39	3,37	11	37,09	CHI
202012130754	ANAPOLIS	AN12401788	ANAPOLIS UNIVERSITARIO S2	23/12/2020 08:16	23/12/2020 15:55	23/12/2020 08:16	23/12/2020 15:55	7,65	26	198,89	CHI
202012131912	CRISTALINA	KR12168488	CRISTALINA S1	23/12/2020 08:17	23/12/2020 13:50	23/12/2020 08:17	23/12/2020 13:50	5,54	32	177,26	CHI
202012132438	SENADOR CANEDO	SW12062064	CEPAIGO S2	23/12/2020 08:17	23/12/2020 15:10	23/12/2020 08:17	23/12/2020 15:10	6,87	1	6,87	CHI
202012132438	BELA VISTA DE GOIAS	SW12062064	CEPAIGO S2	23/12/2020 08:17	23/12/2020 15:10	23/12/2020 08:17	23/12/2020 15:10	6,87	3	20,61	CHI
202012130597	MINEIROS	MY12252580	PARQUE DAS EMAS	23/12/2020 08:19	23/12/2020 11:42	23/12/2020 08:19	23/12/2020 11:42	3,40	6	20,38	CHI
202012130601	URUTAI	460114645	URUTAI	23/12/2020 08:19	23/12/2020 09:20	23/12/2020 08:19	23/12/2020 09:20	1,01	1	1,01	CHI
202012130611	SANCLERLANDIA	SC12391513	FIRMINOPOLIS S2	23/12/2020 08:20	23/12/2020 10:16	23/12/2020 08:20	23/12/2020 10:16	1,93	1	1,93	CHI
202012130621	ITABERAI	GS12083940	ITABERAI S1	23/12/2020 08:21	23/12/2020 17:58	23/12/2020 08:21	23/12/2020 17:58	9,61	2	19,22	CHI
202012130621	GOIAS	GS12083940	ITABERAI S1	23/12/2020 08:21	23/12/2020 17:58	23/12/2020 08:21	23/12/2020 17:58	9,61	18	172,97	CHI
202012130626	GOIANIA	12718970	FERROVIARIO S3	23/12/2020 08:21	23/12/2020 13:59	23/12/2020 08:21	23/12/2020 13:59	5,63	1	5,63	CHI
202012130627	FORMOSA	FA12334131	SAO JOAO D ALIANCA	23/12/2020 08:21	23/12/2020 21:43	23/12/2020 08:21	23/12/2020 21:43	13,35	2	26,70	CHI
202012130834	FAINA	FC12204586	GOIAS	23/12/2020 08:22	23/12/2020 15:11	23/12/2020 08:22	23/12/2020 15:11	6,80	3	20,41	CHI
202012130867	POSSE	PS12123497	IACIARA S2	23/12/2020 08:22	23/12/2020 23:43	23/12/2020 08:22	23/12/2020 23:43	15,35	15	230,25	CHI
202012130967	GOIAS	GS12307627	GOIAS	23/12/2020 08:22	23/12/2020 13:17	23/12/2020 08:22	23/12/2020 13:17	4,91	5	24,57	CHI
202012132540	PIRES DO RIO	PR12000035LD	PIRES DO RIO S1	23/12/2020 08:22	23/12/2020 13:51	23/12/2020 08:22	23/12/2020 13:51	5,47	61	333,64	CHI

202012130665	ITAPURANGA	IK12426653	ITAPURANGA	23/12/2020 08:24	23/12/2020 10:23	23/12/2020 08:24	23/12/2020 10:23	1,97	15	29,59	CHI
202012131006	ITUMBIARA	IT12000091	PARANAIBA	23/12/2020 08:24	23/12/2020 13:01	23/12/2020 08:24	23/12/2020 13:01	4,62	12	55,42	CHI
202012131791	PROFESSOR JAMIL SAFADY	JS12000039	PONTALINA	23/12/2020 08:24	23/12/2020 11:52	23/12/2020 08:24	23/12/2020 11:52	3,46	34	117,52	CHI
202012130692	SILVANIA	SV12281886	VIANOPOLIS	23/12/2020 08:26	23/12/2020 21:25	23/12/2020 08:26	23/12/2020 21:25	12,97	113	1465,45	CHI
202012130721	GOIANIA	GN21001836	FERROVIARIO S1	23/12/2020 08:29	23/12/2020 11:43	23/12/2020 11:07	23/12/2020 11:43	0,61	1	0,61	CHI
202012130732	RIO VERDE	630511100	RIO VERDE S2	23/12/2020 08:30	23/12/2020 20:20	23/12/2020 08:30	23/12/2020 20:20	11,82	1	11,82	CHI
202012131365	TEREZOPOLIS DE GOIAS	GP12000094	DAIA S2	23/12/2020 08:30	24/12/2020 08:57	23/12/2020 08:30	24/12/2020 08:57	24,45	20	488,97	CHI
202012131365	GOIANAPOLIS	GP12000094	DAIA S2	23/12/2020 08:30	24/12/2020 08:57	23/12/2020 08:30	24/12/2020 08:57	24,45	4	97,79	CHI
202012179388	CAVALCANTE	TI10396052	NIQUELANDIA SUBTRANSMISSAO	23/12/2020 08:30	23/12/2020 17:33	23/12/2020 08:55	23/12/2020 08:58	0,06	58	3,45	CHI
202012179388	ALTO PARAISO DE GOIAS	TI10396052	NIQUELANDIA SUBTRANSMISSAO	23/12/2020 08:30	23/12/2020 17:33	23/12/2020 08:55	23/12/2020 08:58	0,06	572	34,00	CHI
202012179388	COLINAS DO SUL	TI10396052	NIQUELANDIA SUBTRANSMISSAO	23/12/2020 08:30	23/12/2020 17:33	23/12/2020 08:55	23/12/2020 08:58	0,06	1240	73,71	CHI
202012179388	NIQUELANDIA	TI10396052	NIQUELANDIA SUBTRANSMISSAO	23/12/2020 08:30	23/12/2020 17:33	23/12/2020 08:55	23/12/2020 08:58	0,06	1165	69,25	CHI
202012179388	NIQUELANDIA	05830414	NIQUELANDIA SUBTRANSMISSAO	23/12/2020 08:30	23/12/2020 17:33	23/12/2020 08:55	23/12/2020 09:51	0,93	1	0,93	CHI
202012179388	NIQUELANDIA	05830414	NIQUELANDIA SUBTRANSMISSAO	23/12/2020 08:30	23/12/2020 17:33	23/12/2020 08:55	23/12/2020 09:51	0,93	596	557,09	CHI
202012179388	NIQUELANDIA	05830414	NIQUELANDIA SUBTRANSMISSAO	23/12/2020 08:30	23/12/2020 17:33	23/12/2020 08:55	23/12/2020 09:51	0,93	5483	5125,08	CHI
202012179388	NIQUELANDIA	05830414	NIQUELANDIA SUBTRANSMISSAO	23/12/2020 08:30	23/12/2020 17:33	23/12/2020 08:55	23/12/2020 09:51	0,93	1	0,93	CHI
202012179388	NIQUELANDIA	05830414	NIQUELANDIA SUBTRANSMISSAO	23/12/2020 08:30	23/12/2020 17:33	23/12/2020 08:55	23/12/2020 09:51	0,93	6799	6355,18	CHI
202012179388	NIQUELANDIA	05830414	NIQUELANDIA SUBTRANSMISSAO	23/12/2020 08:30	23/12/2020 17:33	23/12/2020 08:55	23/12/2020 11:19	2,41	801	1929,74	CHI
202012179388	NIQUELANDIA	NQ16410964	NIQUELANDIA SUBTRANSMISSAO	23/12/2020 08:30	23/12/2020 17:33	23/12/2020 09:53	23/12/2020 12:47	2,89	680	1965,77	CHI
202012179388	NIQUELANDIA	NQ16410964	NIQUELANDIA SUBTRANSMISSAO	23/12/2020 08:30	23/12/2020 17:33	23/12/2020 09:53	23/12/2020 13:02	3,15	2728	8602,29	CHI
202012179388	COLINAS DO SUL	BF10395392	NIQUELANDIA SUBTRANSMISSAO	23/12/2020 08:30	23/12/2020 17:33	23/12/2020 15:44	23/12/2020 15:56	0,20	67	13,40	CHI
202012179388	NIQUELANDIA	BF10395392	NIQUELANDIA SUBTRANSMISSAO	23/12/2020 08:30	23/12/2020 17:33	23/12/2020 15:44	23/12/2020 15:56	0,20	4	0,80	CHI
202012179388	CAVALCANTE	BF10395392	NIQUELANDIA SUBTRANSMISSAO	23/12/2020 08:30	23/12/2020 17:33	23/12/2020 15:44	23/12/2020 15:56	0,20	58	11,60	CHI
202012179388	ALTO PARAISO DE GOIAS	BF10395392	NIQUELANDIA SUBTRANSMISSAO	23/12/2020 08:30	23/12/2020 17:33	23/12/2020 15:44	23/12/2020 15:56	0,20	572	114,40	CHI
202012179388	COLINAS DO SUL	BF10395392	NIQUELANDIA SUBTRANSMISSAO	23/12/2020 08:30	23/12/2020 17:33	23/12/2020 15:44	23/12/2020 15:56	0,19	1152	221,76	CHI
202012179388	NIQUELANDIA	NQ16410964	NIQUELANDIA SUBTRANSMISSAO	23/12/2020 08:30	23/12/2020 17:33	23/12/2020 09:53	23/12/2020 16:23	6,50	2	12,99	CHI
202012179388	NIQUELANDIA	NQ10374709	NIQUELANDIA SUBTRANSMISSAO	23/12/2020 08:30	23/12/2020 17:33	23/12/2020 15:44	23/12/2020 16:38	0,91	801	725,35	CHI
202012179388	COLINAS DO SUL	NQ10419863	NIQUELANDIA SUBTRANSMISSAO	23/12/2020 08:30	23/12/2020 17:33	23/12/2020 15:44	23/12/2020 16:39	0,91	21	19,17	CHI
202012179388	NIQUELANDIA	NQ10419863	NIQUELANDIA SUBTRANSMISSAO	23/12/2020 08:30	23/12/2020 17:33	23/12/2020 15:44	23/12/2020 16:39	0,91	1162	1060,65	CHI
202012179388	COLINAS DO SUL	TI10401551	MINACU	23/12/2020 08:30	23/12/2020 17:33	23/12/2020 15:44	23/12/2020 16:55	1,19	447	530,44	CHI
202012179388	URUACU	TI10401551	MINACU	23/12/2020 08:30	23/12/2020 17:33	23/12/2020 15:44	23/12/2020 16:55	1,19	1	1,19	CHI
202012179388	CAVALCANTE	TI10401551	MINACU	23/12/2020 08:30	23/12/2020 17:33	23/12/2020 15:44	23/12/2020 16:55	1,19	387	459,24	CHI
202012179388	NIQUELANDIA	TI10401551	MINACU	23/12/2020 08:30	23/12/2020 17:33	23/12/2020 15:44	23/12/2020 16:55	1,19	1	1,19	CHI
202012179388	NIQUELANDIA	NQ11000011	NIQUELANDIA SUBTRANSMISSAO	23/12/2020 08:30	23/12/2020 17:33	23/12/2020 09:53	23/12/2020 17:33	7,66	35	268,05	CHI
202012130741	CAMPOS VERDES	NH12396799	SANTA TEREZINHA	23/12/2020 08:31	23/12/2020 11:23	23/12/2020 08:31	23/12/2020 11:23	2,86	5	14,28	CHI
202012130741	ALTO HORIZONTE	NH12396799	SANTA TEREZINHA	23/12/2020 08:31	23/12/2020 11:23	23/12/2020 08:31	23/12/2020 11:23	2,86	18	51,42	CHI
202012130752	JATAI	JT12182073	JATAI S1	23/12/2020 08:32	23/12/2020 12:35	23/12/2020 08:32	23/12/2020 12:35	4,05	2	8,10	CHI
202012131217	PILAR DE GOIAS	GG12318446RE	URUACU	23/12/2020 08:32	23/12/2020 14:21	23/12/2020 08:32	23/12/2020 14:21	5,80	118	684,76	CHI
202012131217	GUARINOS	GG12318446RE	URUACU	23/12/2020 08:32	23/12/2020 14:21	23/12/2020 08:32	23/12/2020 14:21	5,80	1	5,80	CHI
202012131217	SANTA TEREZINHA DE GOIAS	GG12318446RE	URUACU	23/12/2020 08:32	23/12/2020 14:21	23/12/2020 08:32	23/12/2020 14:21	5,80	4	23,21	CHI
202012134173	SILVANIA	SV12317622	VIANOPOLIS	23/12/2020 08:34	23/12/2020 20:20	23/12/2020 08:34	23/12/2020 20:20	11,76	8	94,09	CHI
202012130807	CORUMBAIBA	AL12263113	VILA CORUMBA	23/12/2020 08:37	23/12/2020 11:15	23/12/2020 08:37	23/12/2020 11:15	2,63	1	2,63	CHI
202012130807	AGUA LIMPA	AL12263113	VILA CORUMBA	23/12/2020 08:37	23/12/2020 11:15	23/12/2020 08:37	23/12/2020 11:15	2,63	33	86,88	CHI
202012130814	QUIRINOPOLIS	QI12052835	QUIRINOPOLIS	23/12/2020 08:37	23/12/2020 11:10	23/12/2020 08:37	23/12/2020 11:10	2,54	2	5,08	CHI
202012130906	SANTA HELENA DE GOIAS	SH12131597	SANTA HELENA S1	23/12/2020 08:37	23/12/2020 20:39	23/12/2020 08:37	23/12/2020 20:39	12,03	5	60,14	CHI
202012131473	SANTA ROSA DE GOIAS	SR12018997	INHUMAS S1	23/12/2020 08:37	23/12/2020 13:59	23/12/2020 08:37	23/12/2020 13:59	5,36	2	10,71	CHI
202012131473	ITAUCU	SR12018997	INHUMAS S1	23/12/2020 08:37	23/12/2020 13:59	23/12/2020 08:37	23/12/2020 13:59	5,36	5	26,78	CHI
202012130821	BELA VISTA DE GOIAS	BV12242071	BELA VISTA S1	23/12/2020 08:38	23/12/2020 10:24	23/12/2020 08:38	23/12/2020 10:24	1,77	3	5,30	CHI
202012131381	GOIANIA	GN12000077	CAMPINAS S1	23/12/2020 08:38	23/12/2020 10:28	23/12/2020 08:38	23/12/2020 10:28	1,83	261	478,43	CHI
202012131658	MARA ROSA	MQ12287615	MARA ROSA	23/12/2020 08:38	23/12/2020 11:22	23/12/2020 08:38	23/12/2020 11:22	2,72	4	10,90	CHI
202012133213	ACREUNA	EU12030223	ACREUNA	23/12/2020 08:38	23/12/2020 16:55	23/12/2020 08:38	23/12/2020 16:55	8,28	3	24,83	CHI



202012130783	SILVANIA	SV12100901	VIANOPOLIS	23/12/2020 08:39	24/12/2020 02:17	23/12/2020 08:39	24/12/2020 02:17	17,62	8	140,95	CHI
202012130835	CACU	CC12323970LD	CACHOEIRA ALTA	23/12/2020 08:39	23/12/2020 13:02	23/12/2020 08:39	23/12/2020 13:02	4,38	3	13,13	CHI
202012132439	TRES RANCHOS	OU12063915	CATALAO S1	23/12/2020 08:40	23/12/2020 18:47	23/12/2020 08:40	23/12/2020 18:47	10,11	2	20,22	CHI
202012130905	ARAGOIANIA	AO32021484	GUAPO S2	23/12/2020 08:41	23/12/2020 16:32	23/12/2020 08:41	23/12/2020 13:50	5,14	4	20,58	CHI
202012130905	ARAGOIANIA	AO21326520	GUAPO S2	23/12/2020 08:41	23/12/2020 16:32	23/12/2020 08:41	23/12/2020 16:32	7,86	1	7,86	CHI
202012131000	ITAUCU	IX12321499	INHUMAS S1	23/12/2020 08:41	23/12/2020 14:50	23/12/2020 08:41	23/12/2020 14:50	6,14	4	24,57	CHI
202012131000	ARACU	IX12321499	INHUMAS S1	23/12/2020 08:41	23/12/2020 14:50	23/12/2020 08:41	23/12/2020 14:50	6,14	8	49,15	CHI
202012130902	ITABERAI	IB12027692	ITABERAI S2	23/12/2020 08:43	23/12/2020 09:12	23/12/2020 08:43	23/12/2020 09:12	0,48	6	2,87	CHI
202012134113	ABADIANIA	AA12414271	ANAPOLIS UNIVERSITARIO S1	23/12/2020 08:43	24/12/2020 10:56	23/12/2020 08:43	24/12/2020 10:56	26,21	3	78,64	CHI
202012130919	ABADIANIA	AA12388791	DAIA S2	23/12/2020 08:44	23/12/2020 23:43	23/12/2020 08:44	23/12/2020 23:43	14,97	3	44,91	CHI
202012132131	CRIXAS	CX12391853	RUBIATABA	23/12/2020 08:44	23/12/2020 15:36	23/12/2020 08:44	23/12/2020 15:36	6,85	9	61,69	CHI
202012133616	CRISTALINA	KR12097123	CRISTALINA S2	23/12/2020 08:44	23/12/2020 20:25	23/12/2020 08:44	23/12/2020 20:25	11,67	3	35,02	CHI
202012131593	RIO VERDE	RV12190361	CABRIUVA S2	23/12/2020 08:45	23/12/2020 19:04	23/12/2020 08:45	23/12/2020 19:04	10,32	11	113,48	CHI
202012130935	RIO VERDE	RV12098479LD	RIO VERDE S1	23/12/2020 08:46	23/12/2020 23:08	23/12/2020 08:46	23/12/2020 23:08	14,38	7	100,63	CHI
202012133531	CORUMBAIBA	CI12000520	VILA CORUMBA	23/12/2020 08:46	23/12/2020 20:58	23/12/2020 08:46	23/12/2020 20:58	12,20	3	36,60	CHI
202012130953	ACREUNA	8576254	ACREUNA	23/12/2020 08:47	23/12/2020 14:08	23/12/2020 08:47	23/12/2020 14:08	5,34	6	32,06	CHI
202012130954	HEITORAI	HE12023247	ITAPURANGA	23/12/2020 08:47	23/12/2020 11:59	23/12/2020 08:47	23/12/2020 11:59	3,19	4	12,77	CHI
202012130968	RIO VERDE	RV12072179	CABRIUVA S2	23/12/2020 08:47	23/12/2020 19:41	23/12/2020 08:47	23/12/2020 19:41	10,89	12	130,66	CHI
202012131952	ARAGARCAS	AG12215842	IPORA	23/12/2020 08:47	23/12/2020 13:40	23/12/2020 08:47	23/12/2020 13:40	4,87	5	24,35	CHI
202012131464	SAO FRANCISCO DE GOIAS	SF12008975	SAO FRANCISCO DE GOIAS	23/12/2020 08:48	23/12/2020 15:32	23/12/2020 08:48	23/12/2020 15:32	6,73	15	100,88	CHI
202012131003	SANTA TEREZINHA DE GOIAS	SG12318449	SANTA TEREZINHA	23/12/2020 08:49	23/12/2020 14:42	23/12/2020 08:49	23/12/2020 14:42	5,88	3	17,65	CHI
202012131003	MARA ROSA	SG12318449	SANTA TEREZINHA	23/12/2020 08:49	23/12/2020 14:42	23/12/2020 08:49	23/12/2020 14:42	5,88	15	88,24	CHI
202012131003	MARPOS VERDES	SG12318449	SANTA TEREZINHA	23/12/2020 08:49	23/12/2020 14:42	23/12/2020 08:49	23/12/2020 14:42	5,88	1	5,88	CHI
202012131012	GOUVELANDIA	QI12000140	QUIRINOPOLIS	23/12/2020 08:49	23/12/2020 11:42	23/12/2020 08:49	23/12/2020 11:42	2,87	12	34,41	CHI
202012134635	ABADIANIA	AA12000611	ANAPOLIS UNIVERSITARIO S1	23/12/2020 08:51	23/12/2020 21:49	23/12/2020 08:51	23/12/2020 21:49	12,95	19	246,13	CHI
202012131018	SENADOR CANEDO	10023060938	SENADOR CANEDO	23/12/2020 08:52	23/12/2020 17:13	23/12/2020 08:52	23/12/2020 17:13	8,35	1	8,35	CHI
202012131028	FAINA	FC12396481	ITAPURANGA	23/12/2020 08:53	23/12/2020 13:05	23/12/2020 08:53	23/12/2020 13:05	4,19	3	12,56	CHI
202012131036	GOIATUBA	140046318	GOIATUBA S2	23/12/2020 08:54	23/12/2020 22:26	23/12/2020 08:54	23/12/2020 22:26	13,53	1	13,53	CHI
202012131297	SAO MIGUEL DO ARAGUAIA	SM12371095	SAO MIGUEL DO ARAGUAIA	23/12/2020 08:54	23/12/2020 11:11	23/12/2020 08:54	23/12/2020 11:11	2,28	1	2,28	CHI
202012131047	LUZIANIA	LZ12261510	CRISTALINA S2	23/12/2020 08:55	23/12/2020 18:43	23/12/2020 08:55	23/12/2020 18:43	9,79	4	39,18	CHI
202012131057	CALDAS NOVAS	CN11290115	SERRA DE CALDAS	23/12/2020 08:56	23/12/2020 22:43	23/12/2020 08:56	23/12/2020 22:43	13,77	9	123,96	CHI
202012131506	PIRES DO RIO	PR12082799	PIRES DO RIO S1	23/12/2020 09:00	23/12/2020 12:10	23/12/2020 09:00	23/12/2020 12:10	3,15	6	18,92	CHI
202012131079	ORIZONA	OZ12390024	PIRES DO RIO S2	23/12/2020 09:01	23/12/2020 13:18	23/12/2020 09:01	23/12/2020 13:18	4,27	4	17,09	CHI
202012131115	AGUA FRIA DE GOIAS	TL12204619	SAO JOAO D ALIANCA	23/12/2020 09:03	23/12/2020 19:10	23/12/2020 09:03	23/12/2020 19:10	10,10	2	20,20	CHI
202012131380	INHUMAS	AR12247240	ARACU	23/12/2020 09:05	23/12/2020 22:03	23/12/2020 09:05	23/12/2020 22:03	12,97	9	116,70	CHI
202012132012	IPORA	DI12063493RE	IPORA	23/12/2020 09:06	23/12/2020 15:59	23/12/2020 09:06	23/12/2020 15:59	6,88	3	20,65	CHI
202012132012	MONTES CLAROS DE GOIAS	DI12063493RE	IPORA	23/12/2020 09:06	23/12/2020 15:59	23/12/2020 09:06	23/12/2020 15:59	6,88	7	48,18	CHI
202012132012	DIORAMA	DI12063493RE	IPORA	23/12/2020 09:06	23/12/2020 15:59	23/12/2020 09:06	23/12/2020 15:59	6,88	37	254,68	CHI
202012131254	HEITORAI	HE12364758	ITAPURANGA	23/12/2020 09:08	23/12/2020 15:56	23/12/2020 09:08	23/12/2020 15:56	6,79	6	40,75	CHI
202012132395	FAZENDA NOVA	FN12060693	IPORA	23/12/2020 09:08	23/12/2020 14:30	23/12/2020 09:08	23/12/2020 14:30	5,35	11	58,87	CHI
202012131159	BURITI ALEGRE	BG12090571	ITUMBIARA VELHA S2	23/12/2020 09:09	23/12/2020 13:32	23/12/2020 09:09	23/12/2020 13:32	4,38	1	4,38	CHI
202012131513	ITAGUARI	II12274243	ITABERAI S1	23/12/2020 09:09	23/12/2020 11:51	23/12/2020 09:09	23/12/2020 11:51	2,70	13	35,04	CHI
202012131513	JARAGUA	II12274243	ITABERAI S1	23/12/2020 09:09	23/12/2020 11:51	23/12/2020 09:09	23/12/2020 11:51	2,70	3	8,09	CHI
202012131166	GOIANIA	GN11001604	CAMPINAS S2	23/12/2020 09:10	23/12/2020 17:00	23/12/2020 09:10	23/12/2020 17:00	7,83	81	634,63	CHI
202012131687	GUAPO	GA12395527	GUAPO S1	23/12/2020 09:11	23/12/2020 12:02	23/12/2020 09:11	23/12/2020 12:02	2,85	211	601,00	CHI
202012131194	URUTAI	UT12027070	URUTAI	23/12/2020 09:13	23/12/2020 11:05	23/12/2020 09:13	23/12/2020 11:05	1,86	3	5,58	CHI
202012131207	MARZAGAO	MG21098602	VILA CORUMBA	23/12/2020 09:14	23/12/2020 12:14	23/12/2020 09:14	23/12/2020 12:14	2,99	1	2,99	CHI
202012131208	CAMPINORTE	CR12172326	MARA ROSA	23/12/2020 09:14	23/12/2020 16:04	23/12/2020 09:14	23/12/2020 16:04	6,82	3	20,46	CHI
202012131208	FORMOSO	CR12172326	MARA ROSA	23/12/2020 09:14	23/12/2020 16:04	23/12/2020 09:14	23/12/2020 16:04	6,82	3	20,46	CHI
202012131224	ANAPOLIS	10008835568	JUNDIAI S2	23/12/2020 09:16	23/12/2020 16:12	23/12/2020 09:16	23/12/2020 16:12	6,94	1	6,94	CHI
202012131227	EDEIA	8171742	EDEIA	23/12/2020 09:16	23/12/2020 13:23	23/12/2020 09:16	23/12/2020 13:23	4,11	6	24,65	CHI

202012131229	PIRES DO RIO	PR12270810	PIRES DO RIO S1	23/12/2020 09:16	23/12/2020 13:19	23/12/2020 09:16	23/12/2020 13:19	4,04	31	125,17	CHI
202012131236	INACIOLANDIA	ID12384054	QUIRINOPOLIS	23/12/2020 09:17	23/12/2020 10:40	23/12/2020 09:17	23/12/2020 10:40	1,37	2	2,75	CHI
202012131238	GOIAS	GS12310531	GOIAS	23/12/2020 09:17	23/12/2020 18:51	23/12/2020 09:17	23/12/2020 18:51	9,56	19	181,55	CHI
202012131238	ITAPURANGA	GS12310531	GOIAS	23/12/2020 09:17	23/12/2020 18:51	23/12/2020 09:17	23/12/2020 18:51	9,56	2	19,11	CHI
202012131238	GUARAITA	GS12310531	GOIAS	23/12/2020 09:17	23/12/2020 18:51	23/12/2020 09:17	23/12/2020 18:51	9,56	2	19,11	CHI
202012131862	SANTA HELENA DE GOIAS	SH12279542	SANTA HELENA S1	23/12/2020 09:20	23/12/2020 17:44	23/12/2020 09:20	23/12/2020 17:44	8,40	1	8,40	CHI
202012131272	CALDAS NOVAS	CN12363788	SERRA DE CALDAS	23/12/2020 09:21	23/12/2020 16:15	23/12/2020 09:21	23/12/2020 16:15	6,89	1	6,89	CHI
202012131283	JARAGUA	70065858	JARAGUA	23/12/2020 09:23	24/12/2020 14:15	23/12/2020 09:23	24/12/2020 14:15	28,87	1	28,87	CHI
202012131316	OUVIDOR	OU12358277	CATALAO S1	23/12/2020 09:25	23/12/2020 15:34	23/12/2020 12:45	23/12/2020 15:34	2,81	4	11,25	CHI
202012131918	INACIOLANDIA	ID32128272	QUIRINOPOLIS	23/12/2020 09:25	23/12/2020 11:39	23/12/2020 09:25	23/12/2020 11:39	2,23	8	17,86	CHI
202012179405	OUVIDOR	OU21337544	CATALAO S1	23/12/2020 09:25	24/12/2020 00:31	23/12/2020 09:25	24/12/2020 00:31	15,09	1	15,09	CHI
202012131342	ARAGOIANIA	AO11216857	GUAPO S2	23/12/2020 09:27	23/12/2020 12:54	23/12/2020 09:27	23/12/2020 12:54	3,44	33	113,63	CHI
202012131343	CORREGO DO OURO	CO12229147	SAO LUIZ DOS MONTES BELOS	23/12/2020 09:27	23/12/2020 11:46	23/12/2020 09:27	23/12/2020 11:46	2,31	1	2,31	CHI
202012131569	PONTALINA	PK12047065	PONTALINA	23/12/2020 09:27	23/12/2020 11:25	23/12/2020 09:27	23/12/2020 11:25	1,96	10	19,60	CHI
202012131774	MORRINHOS	MR32060398	MORRINHOS	23/12/2020 09:27	23/12/2020 15:01	23/12/2020 09:27	23/12/2020 15:01	5,56	8	44,51	CHI
202012131377	MARZAGAO	MG12182533	VILA CORUMBA	23/12/2020 09:28	24/12/2020 03:32	23/12/2020 09:28	24/12/2020 03:32	18,06	3	54,19	CHI
202012131377	RIO QUENTE	MG12182533	VILA CORUMBA	23/12/2020 09:28	24/12/2020 03:32	23/12/2020 09:28	24/12/2020 03:32	18,06	3	54,19	CHI
202012131358	IPAMERI	IP12272801	IPAMERI	23/12/2020 09:29	23/12/2020 15:23	23/12/2020 09:29	23/12/2020 15:23	5,89	12	70,68	CHI
202012131364	RIO VERDE	RV12000297	RIO VERDE S1	23/12/2020 09:29	23/12/2020 12:52	23/12/2020 09:29	23/12/2020 12:52	3,37	5	16,83	CHI
202012132076	PADRE BERNARDO	PB12377642	PADRE BERNARDO	23/12/2020 09:30	23/12/2020 13:28	23/12/2020 09:30	23/12/2020 13:28	3,96	3	11,88	CHI
202012133544	GOIATUBA	BJ12000202	CACHOEIRA DOURADA	23/12/2020 09:30	23/12/2020 16:51	23/12/2020 09:30	23/12/2020 16:51	7,33	6	44,01	CHI
202012133544	BOM JESUS DE GOIAS	BJ12000202	CACHOEIRA DOURADA	23/12/2020 09:30	23/12/2020 16:51	23/12/2020 09:30	23/12/2020 16:51	7,33	23	168,70	CHI
202012133544	PANAMA	BJ12000202	CACHOEIRA DOURADA	23/12/2020 09:30	23/12/2020 16:51	23/12/2020 09:30	23/12/2020 16:51	7,33	2	14,67	CHI
202012131391	CRIXAS	CX12190022	RUBIATABA	23/12/2020 09:31	23/12/2020 15:28	23/12/2020 09:31	23/12/2020 15:28	5,95	18	107,07	CHI
202012131399	NIQUELANDIA	NQ12293907	URUACU	23/12/2020 09:35	23/12/2020 11:58	23/12/2020 09:35	23/12/2020 11:58	2,38	4	9,51	CHI
202012131733	NOVA IGUACU DE GOIAS	NH12270877	CAMPINORTE	23/12/2020 09:36	23/12/2020 17:15	23/12/2020 09:36	23/12/2020 17:15	7,65	5	38,25	CHI
202012131415	URUACU	UR12374580	URUACU	23/12/2020 09:37	23/12/2020 11:14	23/12/2020 09:37	23/12/2020 11:14	1,61	2	3,23	CHI
202012131416	SANTA TEREZA DE GOIAS	SE12288750	MARA ROSA	23/12/2020 09:37	23/12/2020 12:07	23/12/2020 09:37	23/12/2020 12:07	2,49	4	9,98	CHI
202012131438	RIO VERDE	RV12301462	ACREUNA	23/12/2020 09:39	23/12/2020 15:04	23/12/2020 09:39	23/12/2020 15:04	5,41	4	21,65	CHI
202012131438	SANTO ANTONIO DA BARRA	RV12301462	ACREUNA	23/12/2020 09:39	23/12/2020 15:04	23/12/2020 09:39	23/12/2020 15:04	5,41	1	5,41	CHI
202012131457	ACREUNA	EU21100856	ACREUNA	23/12/2020 09:40	23/12/2020 13:20	23/12/2020 09:40	23/12/2020 13:20	3,67	1	3,67	CHI
202012131470	CAMPINACU	IH12132432	MINACU	23/12/2020 09:41	23/12/2020 10:08	23/12/2020 09:41	23/12/2020 10:08	0,44	22	9,67	CHI
202012131470	MINACU	IH12132432	MINACU	23/12/2020 09:41	23/12/2020 10:08	23/12/2020 09:41	23/12/2020 10:08	0,44	108	47,46	CHI
202012131494	SAO LUIS DE MONTES BELOS	SL11194189	SAO LUIZ DOS MONTES BELOS	23/12/2020 09:41	23/12/2020 12:00	23/12/2020 09:41	23/12/2020 12:00	2,32	8	18,52	CHI
202012132035	RUBIATABA	RB12292125	RUBIATABA	23/12/2020 09:41	23/12/2020 21:29	23/12/2020 09:41	23/12/2020 21:29	11,79	3	35,36	CHI
202012131499	SILVANIA	SV12282723	VIANOPOLIS	23/12/2020 09:46	23/12/2020 15:18	23/12/2020 09:46	23/12/2020 15:18	5,52	6	33,13	CHI
202012131512	ITAPIRAPUA	IU12072448	MATRINCHA	23/12/2020 09:49	24/12/2020 12:03	23/12/2020 09:49	24/12/2020 12:03	26,23	2	52,46	CHI
202012131518	INDIARA	IY12395081	EDEIA	23/12/2020 09:50	23/12/2020 21:47	23/12/2020 09:50	23/12/2020 19:38	9,79	510	4994,74	CHI
202012131518	INDIARA	IY12395081	EDEIA	23/12/2020 09:50	23/12/2020 21:47	23/12/2020 19:45	23/12/2020 21:47	2,03	510	1036,72	CHI
202012131526	PONTALINA	PK12047371RE	VICENTINOPOLIS	23/12/2020 09:51	23/12/2020 13:24	23/12/2020 09:51	23/12/2020 13:24	3,54	49	173,50	CHI
202012131588	PALESTINA DE GOIAS	PY12040193	PALESTINA	23/12/2020 09:51	23/12/2020 10:45	23/12/2020 09:51	23/12/2020 10:45	0,89	81	72,22	CHI
202012131532	CAIAPONIA	CP12365188	PIRANHAS	23/12/2020 09:52	23/12/2020 16:20	23/12/2020 09:52	23/12/2020 16:20	6,47	2	12,94	CHI
202012131551	PALMEIRAS DE GOIAS	PL12000092	PALMEIRAS	23/12/2020 09:52	23/12/2020 11:18	23/12/2020 09:52	23/12/2020 11:18	1,42	3	4,25	CHI
202012131563	NOVA IGUACU DE GOIAS	10002220464	SANTA TEREZINHA	23/12/2020 09:54	23/12/2020 22:47	23/12/2020 09:54	23/12/2020 22:47	12,89	1	12,89	CHI
202012131565	GOIANIA	14734060	GOYA S2	23/12/2020 09:54	23/12/2020 16:35	23/12/2020 09:54	23/12/2020 16:35	6,68	1	6,68	CHI
202012131568	PIRACANJUBA	PJ12209123	PIRACANJUBA	23/12/2020 09:54	23/12/2020 11:07	23/12/2020 09:54	23/12/2020 11:07	1,20	148	178,05	CHI
202012131573	SAO MIGUEL DO ARAGUAIA	SM11240788	SAO MIGUEL DO ARAGUAIA	23/12/2020 09:55	23/12/2020 13:04	23/12/2020 09:55	23/12/2020 13:04	3,16	1	3,16	CHI
202012131580	CALDAS NOVAS	10032788108	SERRA DE CALDAS	23/12/2020 09:56	24/12/2020 00:18	23/12/2020 09:56	24/12/2020 00:18	14,38	1	14,38	CHI
202012131598	RIO VERDE	RV21200796	RIO VERDE S2	23/12/2020 09:58	23/12/2020 16:53	23/12/2020 09:58	23/12/2020 16:53	6,90	5	34,51	CHI
202012131602	SAO MIGUEL DO ARAGUAIA	SM12349178	SAO MIGUEL DO ARAGUAIA	23/12/2020 09:59	23/12/2020 16:05	23/12/2020 09:59	23/12/2020 16:05	6,10	84	512,03	CHI
202012131950	SILVANIA	SV12389473	VIANOPOLIS	23/12/2020 09:59	23/12/2020 15:58	23/12/2020 09:59	23/12/2020 15:58	5,98	10	59,79	CHI

202012132244	ITABERAÍ	IB12093885	ITABERAÍ S1	23/12/2020 09:59	23/12/2020 13:18	23/12/2020 09:59	23/12/2020 13:18	3,30	8	26,41	CHI
202012131649	PARANAIGUARA	PC12240069	CACHOEIRA ALTA	23/12/2020 10:03	23/12/2020 13:05	23/12/2020 10:03	23/12/2020 13:05	3,03	3	9,09	CHI
202012131652	QUIRINOPOLIS	QI32191935	QUIRINOPOLIS	23/12/2020 10:03	23/12/2020 16:53	23/12/2020 10:03	23/12/2020 16:53	6,83	3	20,48	CHI
202012131666	CRISTALINA	KR12261531	CRISTALINA S1	23/12/2020 10:04	23/12/2020 21:04	23/12/2020 10:04	23/12/2020 21:04	10,99	4	43,95	CHI
202012131676	CRISTALINA	KR12219211	CRISTALINA S1	23/12/2020 10:06	23/12/2020 15:43	23/12/2020 10:06	23/12/2020 15:43	5,60	2	11,21	CHI
202012132556	MATRINCHA	MP12306822	MATRINCHA	23/12/2020 10:06	23/12/2020 18:51	23/12/2020 10:06	23/12/2020 18:51	8,75	38	332,36	CHI
202012132016	MATRINCHA	MP12098851	MATRINCHA	23/12/2020 10:07	24/12/2020 01:16	23/12/2020 10:07	24/12/2020 01:16	15,14	82	1241,78	CHI
202012131690	POUVELANDIA	PW21326313	PARQUE DAS EMAS	23/12/2020 10:08	23/12/2020 12:35	23/12/2020 10:08	23/12/2020 12:35	2,44	1	2,44	CHI
202012131700	GOUVELANDIA	GB21301506	QUIRINOPOLIS	23/12/2020 10:09	23/12/2020 15:40	23/12/2020 10:09	23/12/2020 15:40	5,50	1	5,50	CHI
202012132192	TRINDADE	TR12180194	TRINDADE	23/12/2020 10:09	23/12/2020 12:36	23/12/2020 10:09	23/12/2020 12:36	2,44	73	178,16	CHI
202012131726	ITUMBIAIRA	IT12305396	CACHOEIRA DOURADA	23/12/2020 10:13	23/12/2020 20:35	23/12/2020 10:13	23/12/2020 20:35	10,36	23	238,28	CHI
202012131726	PANAMA	IT12305396	CACHOEIRA DOURADA	23/12/2020 10:13	23/12/2020 20:35	23/12/2020 10:13	23/12/2020 20:35	10,36	5	51,80	CHI
202012131728	CACHOEIRA ALTA	1090034754	CACHOEIRA ALTA	23/12/2020 10:13	23/12/2020 13:20	23/12/2020 10:13	23/12/2020 13:20	3,11	1	3,11	CHI
202012132557	ITAUCU	IX12321505	INHUMAS S1	23/12/2020 10:14	23/12/2020 15:33	23/12/2020 10:14	23/12/2020 15:33	5,31	20	106,12	CHI
202012132557	ITABERAÍ	IX12321505	INHUMAS S1	23/12/2020 10:14	23/12/2020 15:33	23/12/2020 10:14	23/12/2020 15:33	5,31	1	5,31	CHI
202012131803	ALEXANIA	AX12351023	ALEXANIA	23/12/2020 10:16	23/12/2020 18:56	23/12/2020 10:16	23/12/2020 18:56	8,67	15	129,98	CHI
202012131765	GOIAS	GS12336540	GOIAS	23/12/2020 10:17	23/12/2020 12:11	23/12/2020 10:17	23/12/2020 12:11	1,89	7	13,24	CHI
202012132601	PIRENOPOLIS	PV12382168	CORUMBA	23/12/2020 10:17	24/12/2020 08:15	23/12/2020 10:17	24/12/2020 08:15	21,97	11	241,63	CHI
202012128093	SANTA RITA DO ARAGUAIA	SU12301950RE	SANTA RITA DO ARAGUAIA	23/12/2020 10:19	23/12/2020 11:44	23/12/2020 10:19	23/12/2020 11:44	1,40	22	30,86	CHI
202012128093	BURITINOPOLIS	SU12301950RE	SANTA RITA DO ARAGUAIA	23/12/2020 10:19	23/12/2020 11:44	23/12/2020 10:19	23/12/2020 11:44	1,40	1	1,40	CHI
202012131797	GOIAS	GS12076721	GOIAS	23/12/2020 10:21	23/12/2020 13:00	23/12/2020 10:21	23/12/2020 13:00	2,63	23	60,60	CHI
202012131793	HIDROLINA	SZ12262918RE	ITAPACI	23/12/2020 10:22	23/12/2020 13:10	23/12/2020 10:22	23/12/2020 13:10	2,79	11	30,73	CHI
202012132676	ITAPIRAPUA	IU12067919	MATRINCHA	23/12/2020 10:24	23/12/2020 17:50	23/12/2020 10:24	23/12/2020 15:39	5,24	1	5,24	CHI
202012132676	ITAPIRAPUA	IU12067919	MATRINCHA	23/12/2020 10:24	23/12/2020 17:50	23/12/2020 10:24	23/12/2020 17:50	7,43	7	51,98	CHI
202012131833	AMARALINA	LC12270121	SAO MIGUEL DO ARAGUAIA	23/12/2020 10:27	23/12/2020 13:57	23/12/2020 10:27	23/12/2020 13:57	3,49	5	17,44	CHI
202012132359	MOSSAMEDES	MD12060620	ITABERAÍ S2	23/12/2020 10:27	23/12/2020 15:27	23/12/2020 10:27	23/12/2020 15:27	4,99	10	49,93	CHI
202012131854	PARAUNA	CG12391526	FIRMINOPOLIS S2	23/12/2020 10:30	23/12/2020 17:45	23/12/2020 10:30	23/12/2020 17:45	7,24	32	231,53	CHI
202012131854	CACHOEIRA DE GOIAS	CG12391526	FIRMINOPOLIS S2	23/12/2020 10:30	23/12/2020 17:45	23/12/2020 10:30	23/12/2020 17:45	7,24	11	79,59	CHI
202012131854	AURILANDIA	CG12391526	FIRMINOPOLIS S2	23/12/2020 10:30	23/12/2020 17:45	23/12/2020 10:30	23/12/2020 17:45	7,24	2	14,47	CHI
202012131857	SANTO ANTONIO DE GOIAS	GR12002131LD	NEROPOLIS S1	23/12/2020 10:31	23/12/2020 18:19	23/12/2020 10:31	23/12/2020 18:19	7,80	1	7,80	CHI
202012131857	NOVA VENEZA	GR12002131LD	NEROPOLIS S1	23/12/2020 10:31	23/12/2020 18:19	23/12/2020 10:31	23/12/2020 18:19	7,80	1	7,80	CHI
202012131858	ARAGARCAS	AG12334918	ARAGARCAS	23/12/2020 10:31	23/12/2020 14:30	23/12/2020 10:31	23/12/2020 14:30	3,97	3	11,92	CHI
202012132711	SANTA FE DE GOIAS	RN12196350	JUSSARA	23/12/2020 10:31	24/12/2020 17:04	23/12/2020 10:31	24/12/2020 17:04	30,54	10	305,36	CHI
202012131889	URUACU	10026277423	URUACU	23/12/2020 10:33	23/12/2020 15:24	23/12/2020 10:33	23/12/2020 15:24	4,85	1	4,85	CHI
202012133960	HIDROLINA	HL12190239	ITAPACI	23/12/2020 10:39	23/12/2020 18:59	23/12/2020 10:39	23/12/2020 18:59	8,33	14	116,65	CHI
202012131933	CRISTALINA	KR12320036	CRISTALINA S2	23/12/2020 10:41	23/12/2020 11:32	23/12/2020 10:41	23/12/2020 11:32	0,85	11	9,32	CHI
202012131937	TURVELANDIA	EU12026720	RIO DOS BOIS	23/12/2020 10:41	23/12/2020 13:52	23/12/2020 10:41	23/12/2020 13:52	3,17	2	6,34	CHI
202012131942	URUACU	2040022199	CAMPINORTE	23/12/2020 10:42	23/12/2020 23:15	23/12/2020 10:42	23/12/2020 23:15	12,56	1	12,56	CHI
202012131955	CAVALCANTE	CJ12208769	FLORES DE GOIAS	23/12/2020 10:44	23/12/2020 19:22	23/12/2020 10:44	23/12/2020 19:22	8,62	191	1647,06	CHI
202012131963	MINEIROS	10006204366	PARQUE DAS EMAS	23/12/2020 10:45	23/12/2020 15:22	23/12/2020 10:45	23/12/2020 15:22	4,61	1	4,61	CHI
202012132428	CATURAI	CK12048885	ARACU	23/12/2020 10:45	23/12/2020 17:31	23/12/2020 10:45	23/12/2020 17:31	6,75	8	54,03	CHI
202012131983	JANDAIA	JD12373324	PALMEIRAS	23/12/2020 10:49	23/12/2020 13:19	23/12/2020 10:49	23/12/2020 13:19	2,50	149	371,92	CHI
202012132368	CRISTALINA	KR12305272	CRISTALINA S2	23/12/2020 10:50	23/12/2020 16:08	23/12/2020 10:50	23/12/2020 16:08	5,28	10	52,85	CHI
202012131998	GUARAITA	00930214	ITAPURANGA	23/12/2020 10:51	23/12/2020 11:30	23/12/2020 10:51	23/12/2020 11:30	0,65	7	4,58	CHI
202012131998	ITAPURANGA	00930214	ITAPURANGA	23/12/2020 10:51	23/12/2020 11:30	23/12/2020 10:51	23/12/2020 11:30	0,65	6389	4175,92	CHI
202012132001	CRISTALINA	KR1249273	CRISTALINA S2	23/12/2020 10:51	23/12/2020 22:26	23/12/2020 10:51	23/12/2020 22:26	11,58	1	11,58	CHI
202012132516	MARZAGAO	MG11045242	VILA CORUMBA	23/12/2020 10:51	24/12/2020 01:42	23/12/2020 10:51	24/12/2020 01:42	14,87	131	1947,35	CHI
202012132371	QUIRINOPOLIS	QI12273812	QUIRINOPOLIS	23/12/2020 10:56	23/12/2020 15:39	23/12/2020 10:56	23/12/2020 15:39	4,71	7	32,95	CHI
202012128558	ABADIANIA	350005722	ANAPOLIS UNIVERSITARIO S1	23/12/2020 10:57	24/12/2020 05:56	23/12/2020 10:57	24/12/2020 05:56	18,97	1	18,97	CHI
202012133222	INACIOLANDIA	ID12361069	QUIRINOPOLIS	23/12/2020 10:58	23/12/2020 15:26	23/12/2020 10:58	23/12/2020 15:26	4,46	4	17,83	CHI
202012133222	ITUMBIAIRA	ID12361069	QUIRINOPOLIS	23/12/2020 10:58	23/12/2020 15:26	23/12/2020 10:58	23/12/2020 15:26	4,46	3	13,37	CHI

202012132083	ANICUNS	AC12304663	FIRMINOPOLIS S2	23/12/2020 10:59	23/12/2020 14:34	23/12/2020 10:59	23/12/2020 14:34	3,58	11	39,37	CHI
202012132068	AGUAS LINDAS DE GOIAS	LA12044220	AGUAS LINDAS DE GOIAS S2	23/12/2020 11:00	23/12/2020 17:59	23/12/2020 11:00	23/12/2020 17:59	6,98	2	13,96	CHI
202012132073	GOIANDIRA	GD12165160	CATALAO S1	23/12/2020 11:00	23/12/2020 13:12	23/12/2020 11:00	23/12/2020 13:12	2,19	10	21,92	CHI
202012132257	ARAGUAPAZ	AZ12404546	MOZARLANDIA	23/12/2020 11:00	23/12/2020 15:12	23/12/2020 11:00	23/12/2020 15:12	4,19	7	29,32	CHI
202012132088	ITUMBIARA	10015629390	PARANAIBA	23/12/2020 11:02	23/12/2020 18:20	23/12/2020 11:02	23/12/2020 18:20	7,30	1	7,30	CHI
202012132091	TRINDADE	TR12027284	TRINDADE	23/12/2020 11:02	23/12/2020 16:36	23/12/2020 11:02	23/12/2020 16:36	5,55	11	61,10	CHI
202012132099	ITUMBIARA	ID12361052	QUIRINOPOLIS	23/12/2020 11:04	23/12/2020 14:38	23/12/2020 11:04	23/12/2020 14:38	3,55	0	0,00	CHI
202012132099	INACIOLANDIA	ID12361052	QUIRINOPOLIS	23/12/2020 11:04	23/12/2020 14:38	23/12/2020 11:04	23/12/2020 14:38	3,55	4	14,21	CHI
202012132656	INDIARA	IY12205923	EDEIA	23/12/2020 11:04	23/12/2020 17:40	23/12/2020 11:04	23/12/2020 17:40	6,60	33	217,74	CHI
202012132656	PALMEIRAS DE GOIAS	IY12205923	EDEIA	23/12/2020 11:04	23/12/2020 17:40	23/12/2020 11:04	23/12/2020 17:40	6,60	5	32,99	CHI
202012132597	GOIANIRA	GR12033390	GOIANIRA	23/12/2020 11:06	23/12/2020 15:51	23/12/2020 11:06	23/12/2020 15:51	4,75	20	94,98	CHI
202012132597	INHUMAS	GR12033390	GOIANIRA	23/12/2020 11:06	23/12/2020 15:51	23/12/2020 11:06	23/12/2020 15:51	4,75	9	42,74	CHI
202012132597	CATURAI	GR12033390	GOIANIRA	23/12/2020 11:06	23/12/2020 15:51	23/12/2020 11:06	23/12/2020 15:51	4,75	161	764,62	CHI
202012133255	SANTA CRUZ DE GOIAS	BC12095321	PIRES DO RIO S2	23/12/2020 11:06	23/12/2020 18:05	23/12/2020 11:06	23/12/2020 18:05	6,97	14	97,65	CHI
202012132114	ITABERAI	IB12238849	ITABERAI S2	23/12/2020 11:07	23/12/2020 13:00	23/12/2020 11:07	23/12/2020 13:00	1,87	2	3,75	CHI
202012133098	IPAMERI	IP12332893	URUTAI	23/12/2020 11:07	23/12/2020 22:09	23/12/2020 11:07	23/12/2020 22:09	11,03	3	33,08	CHI
202012132123	SANTA BARBARA DE GOIAS	SB12215254	TRINDADE	23/12/2020 11:08	23/12/2020 14:06	23/12/2020 11:08	23/12/2020 14:06	2,96	5	14,78	CHI
202012132136	PARAUNA	PU12205943RE	PARAUNA	23/12/2020 11:09	23/12/2020 15:36	23/12/2020 11:09	23/12/2020 15:36	4,43	25	110,87	CHI
202012132136	JANDAIA	PU12205943RE	PARAUNA	23/12/2020 11:09	23/12/2020 15:36	23/12/2020 11:09	23/12/2020 15:36	4,43	3	13,30	CHI
202012132138	GOIANIA	10017804700	XAVANTES	23/12/2020 11:09	23/12/2020 18:24	23/12/2020 11:09	23/12/2020 18:24	7,25	1	7,25	CHI
202012132140	FORMOSA	FA12208803	ITUIQUIRA	23/12/2020 11:10	23/12/2020 14:23	23/12/2020 11:10	23/12/2020 14:23	3,21	1	3,21	CHI
202012132140	CABECEIRAS	FA12208803	ITUIQUIRA	23/12/2020 11:10	23/12/2020 14:23	23/12/2020 11:10	23/12/2020 14:23	3,21	3	9,63	CHI
202012131063	CORUMBAIBA	CI12000543	VILA CORUMBA	23/12/2020 11:11	23/12/2020 16:47	23/12/2020 11:11	23/12/2020 16:47	5,59	9	50,35	CHI
202012132350	MARA ROSA	VD12201669	SANTA TEREZINHA	23/12/2020 11:12	23/12/2020 16:32	23/12/2020 11:12	23/12/2020 16:32	5,32	2	10,64	CHI
202012132209	NIQUELANDIA	NQ12239432	URUACU	23/12/2020 11:13	23/12/2020 15:21	23/12/2020 11:13	23/12/2020 15:21	4,13	21	86,65	CHI
202012132189	NOVO BRASIL	NB21353088	JUSSARA	23/12/2020 11:16	23/12/2020 17:45	23/12/2020 11:16	23/12/2020 17:45	6,48	1	6,48	CHI
202012132210	PALESTINA DE GOIAS	PY21158159	PALESTINA	23/12/2020 11:19	23/12/2020 14:08	23/12/2020 11:19	23/12/2020 14:08	2,80	1	2,80	CHI
202012132406	PIRACANJUBA	PJ12212194	PIRACANJUBA	23/12/2020 11:19	23/12/2020 14:50	23/12/2020 11:19	23/12/2020 14:50	3,51	19	66,77	CHI
202012132211	GUAPO	GA12000019	GUAPO S1	23/12/2020 11:20	23/12/2020 13:53	23/12/2020 11:20	23/12/2020 13:53	2,54	1	2,54	CHI
202012132215	PANAMA	PX11166390	GOIATUBA S1	23/12/2020 11:20	23/12/2020 19:17	23/12/2020 11:20	23/12/2020 19:17	7,93	128	1015,61	CHI
202012132225	CATALAO	CT12149116	CATALAO S1	23/12/2020 11:24	23/12/2020 15:30	23/12/2020 11:24	23/12/2020 15:30	4,10	1	4,10	CHI
202012132243	PORTELANDIA	PW21303360	PARQUE DAS EMAS	23/12/2020 11:25	25/12/2020 04:43	23/12/2020 11:25	25/12/2020 04:43	41,30	1	41,30	CHI
202012132247	PORANGATU	TA21242730	NOVO PLANALTO	23/12/2020 11:26	23/12/2020 14:28	23/12/2020 11:26	23/12/2020 14:28	3,03	1	3,03	CHI
202012132255	GOIANIA	14931643	XAVANTES	23/12/2020 11:27	23/12/2020 20:28	23/12/2020 11:27	23/12/2020 20:28	9,02	1	9,02	CHI
202012132273	POSSE	PS11104725	IACIARA S2	23/12/2020 11:30	23/12/2020 19:30	23/12/2020 11:30	23/12/2020 19:30	7,99	116	926,58	CHI
202012132284	GOIANIA	GN12000619	CAMPINAS S2	23/12/2020 11:32	23/12/2020 12:58	23/12/2020 11:32	23/12/2020 12:58	1,43	16	22,92	CHI
202012132301	JUSSARA	04750214	MATRINCHA	23/12/2020 11:35	24/12/2020 12:30	23/12/2020 11:35	23/12/2020 17:50	6,24	3	18,71	CHI
202012132301	ITAPIRAPUA	04750214	MATRINCHA	23/12/2020 11:35	24/12/2020 12:30	23/12/2020 11:35	23/12/2020 17:50	6,24	374	2331,99	CHI
202012132301	JUSSARA	JR12220268	MATRINCHA	23/12/2020 11:35	24/12/2020 12:30	23/12/2020 17:23	23/12/2020 17:50	0,44	1	0,44	CHI
202012132301	ITAPIRAPUA	JR12220268	MATRINCHA	23/12/2020 11:35	24/12/2020 12:30	23/12/2020 17:23	23/12/2020 17:50	0,44	33	14,46	CHI
202012132301	ITAPIRAPUA	JR12220268	JUSSARA	23/12/2020 11:35	24/12/2020 12:30	23/12/2020 17:24	23/12/2020 17:50	0,42	7	2,97	CHI
202012132301	JUSSARA	JR12220268	JUSSARA	23/12/2020 11:35	24/12/2020 12:30	23/12/2020 17:24	23/12/2020 17:50	0,42	26	11,04	CHI
202012132301	SANTA FE DE GOIAS	04750214	MATRINCHA	23/12/2020 11:35	24/12/2020 12:30	23/12/2020 11:35	24/12/2020 12:30	24,92	12	299,01	CHI
202012132301	ITAPIRAPUA	04750214	MATRINCHA	23/12/2020 11:35	24/12/2020 12:30	23/12/2020 11:35	24/12/2020 12:30	24,92	20	498,34	CHI
202012132301	ITAPIRAPUA	JR12220268	MATRINCHA	23/12/2020 11:35	24/12/2020 12:30	23/12/2020 17:23	24/12/2020 12:30	19,12	3	57,36	CHI
202012133331	AGUA FRIA DE GOIAS	TL12383351	SAO JOAO D ALIANCA	23/12/2020 11:37	23/12/2020 18:09	23/12/2020 11:37	23/12/2020 18:09	6,54	1	6,54	CHI
202012133331	PLANALTINA	TL12383351	SAO JOAO D ALIANCA	23/12/2020 11:37	23/12/2020 18:09	23/12/2020 11:37	23/12/2020 18:09	6,54	4	26,18	CHI
202012132354	MINEIROS	MY10402698	PARQUE DAS EMAS	23/12/2020 11:38	26/12/2020 14:07	23/12/2020 11:38	23/12/2020 14:04	2,44	2399	5853,56	CHI
202012132354	MINEIROS	MY13360771	PARQUE DAS EMAS	23/12/2020 11:38	26/12/2020 14:07	23/12/2020 11:38	23/12/2020 15:19	3,68	586	2158,92	CHI
202012132354	MINEIROS	MY13348958	PARQUE DAS EMAS	23/12/2020 11:38	26/12/2020 14:07	23/12/2020 11:38	23/12/2020 17:33	5,92	209	1238,27	CHI
202012132354	MINEIROS	MY10402698	PARQUE DAS EMAS	23/12/2020 11:38	26/12/2020 14:07	23/12/2020 17:33	23/12/2020 17:47	0,22	2985	659,19	CHI

202012132354	MINEIROS	MY13348958	PARQUE DAS EMAS	23/12/2020 11:38	26/12/2020 14:07	23/12/2020 17:46	23/12/2020 23:23	5,62	30	168,59	CHI
202012132354	MINEIROS	MY12402479LD	PARQUE DAS EMAS	23/12/2020 11:38	26/12/2020 14:07	23/12/2020 17:46	24/12/2020 07:39	13,89	65	903,08	CHI
202012132354	MINEIROS	MY10402698	PARQUE DAS EMAS	23/12/2020 11:38	26/12/2020 14:07	24/12/2020 08:07	24/12/2020 08:15	0,12	3080	361,90	CHI
202012132354	MINEIROS	MY13360825	PARQUE DAS EMAS	23/12/2020 11:38	26/12/2020 14:07	23/12/2020 17:46	24/12/2020 09:20	15,58	15	233,69	CHI
202012132354	MINEIROS	MY12101995LD	PARQUE DAS EMAS	23/12/2020 11:38	26/12/2020 14:07	23/12/2020 17:46	24/12/2020 10:03	16,29	4	65,14	CHI
202012132354	MINEIROS	MY13219571	PARQUE DAS EMAS	23/12/2020 11:38	26/12/2020 14:07	23/12/2020 11:38	24/12/2020 10:06	22,47	159	3573,00	CHI
202012132354	MINEIROS	MY12043894RE	PARQUE DAS EMAS	23/12/2020 11:38	26/12/2020 14:07	23/12/2020 17:46	24/12/2020 11:10	17,41	84	1462,63	CHI
202012132354	MINEIROS	MY12043894RE	PARQUE DAS EMAS	23/12/2020 11:38	26/12/2020 14:07	24/12/2020 11:11	24/12/2020 13:12	2,00	5	10,00	CHI
202012132354	MINEIROS	MY12360820	PARQUE DAS EMAS	23/12/2020 11:38	26/12/2020 14:07	23/12/2020 17:46	24/12/2020 13:33	19,78	9	178,05	CHI
202012132354	MINEIROS	MY12043901	PARQUE DAS EMAS	23/12/2020 11:38	26/12/2020 14:07	23/12/2020 17:46	24/12/2020 13:58	20,20	2	40,40	CHI
202012132354	MINEIROS	MY13360827	PARQUE DAS EMAS	23/12/2020 11:38	26/12/2020 14:07	24/12/2020 11:11	24/12/2020 23:15	12,07	21	253,39	CHI
202012132354	MINEIROS	MY13360829	PARQUE DAS EMAS	23/12/2020 11:38	26/12/2020 14:07	24/12/2020 11:11	25/12/2020 16:22	29,18	15	437,72	CHI
202012132354	MINEIROS	MY13360829	PARQUE DAS EMAS	23/12/2020 11:38	26/12/2020 14:07	24/12/2020 11:11	26/12/2020 14:07	50,93	43	2190,09	CHI
202012132354	MINEIROS	MY13360829	PARQUE DAS EMAS	23/12/2020 11:38	26/12/2020 14:07	25/12/2020 21:33	26/12/2020 14:07	16,58	15	248,66	CHI
202012132364	CORUMBAIBA	CY21110134	CATALAO S1	23/12/2020 11:45	23/12/2020 18:41	23/12/2020 11:45	23/12/2020 18:41	6,93	1	6,93	CHI
202012136800	SILVANIA	SV12389456	VIANOPOLIS	23/12/2020 11:45	24/12/2020 10:31	23/12/2020 11:45	24/12/2020 10:31	22,77	23	523,62	CHI
202012132367	FORMOSA	FA12404371	ITUIQUIRA	23/12/2020 11:46	23/12/2020 23:45	23/12/2020 11:46	23/12/2020 17:25	5,64	52	293,31	CHI
202012132367	FLORES DE GOIAS	FA12397042LD	ITUIQUIRA	23/12/2020 11:46	23/12/2020 23:45	23/12/2020 11:46	23/12/2020 23:45	11,98	1	11,98	CHI
202012132367	FORMOSA	FA12397042LD	ITUIQUIRA	23/12/2020 11:46	23/12/2020 23:45	23/12/2020 11:46	23/12/2020 23:45	11,98	38	455,37	CHI
202012132378	PIRACANJUBA	PJ12105811	PIRACANJUBA	23/12/2020 11:48	23/12/2020 17:08	23/12/2020 11:48	23/12/2020 17:08	5,33	1	5,33	CHI
202012132694	ALEXANIA	AX12393199	ALEXANIA	23/12/2020 11:50	23/12/2020 18:41	23/12/2020 11:50	23/12/2020 18:41	6,84	198	1353,55	CHI
202012132621	LEOPOLDO DE BULHOES	LB12000624	DAIA S1	23/12/2020 11:54	23/12/2020 14:42	23/12/2020 11:54	23/12/2020 14:42	2,79	33	92,12	CHI
202012132416	MOZARLANDIA	AZ21143384	MOZARLANDIA	23/12/2020 11:55	24/12/2020 05:30	23/12/2020 11:55	24/12/2020 05:30	17,58	1	17,58	CHI
202012134027	JATAI	JT12374237RE	JATAI S1	23/12/2020 11:56	23/12/2020 23:43	23/12/2020 11:56	23/12/2020 23:43	11,77	12	141,21	CHI
202012133223	INACIOLANDIA	ID32128258	QUIRINOPOLIS	23/12/2020 12:01	23/12/2020 15:50	23/12/2020 12:01	23/12/2020 15:50	3,81	7	26,70	CHI
202012132457	MUNDO NOVO DE GOIAS	MH12380791	NOVA CRIXAS	23/12/2020 12:02	23/12/2020 15:25	23/12/2020 12:02	23/12/2020 15:25	3,38	1	3,38	CHI
202012133870	GOIAS	GS12201029	GOIAS	23/12/2020 12:04	23/12/2020 21:20	23/12/2020 12:04	23/12/2020 21:20	9,25	4	37,02	CHI
202012132477	FIRMINOPOLIS	SL12003853	SAO LUIZ DOS MONTES BELOS	23/12/2020 12:07	23/12/2020 16:44	23/12/2020 12:07	23/12/2020 16:44	4,62	2	9,23	CHI
202012132477	SAO LUIS DE MONTES BELOS	SL12003853	SAO LUIZ DOS MONTES BELOS	23/12/2020 12:07	23/12/2020 16:44	23/12/2020 12:07	23/12/2020 16:44	4,62	107	493,83	CHI
202012132477	AURILANDIA	SL12003853	SAO LUIZ DOS MONTES BELOS	23/12/2020 12:07	23/12/2020 16:44	23/12/2020 12:07	23/12/2020 16:44	4,62	6	27,69	CHI
202012132477	SANCLERLANDIA	SL12003853	SAO LUIZ DOS MONTES BELOS	23/12/2020 12:07	23/12/2020 16:44	23/12/2020 12:07	23/12/2020 16:44	4,62	1	4,62	CHI
202012132478	APARECIDA DE GOIANIA	10027770182	ANHANGUERA	23/12/2020 12:07	23/12/2020 14:18	23/12/2020 12:07	23/12/2020 14:18	2,19	1	2,19	CHI
202012134374	MAURILANDIA	CL12306027	RIO DOS BOIS	23/12/2020 12:07	23/12/2020 22:07	23/12/2020 12:07	23/12/2020 22:07	9,99	3	29,96	CHI
202012134374	PORTEIRAO	CL12306027	RIO DOS BOIS	23/12/2020 12:07	23/12/2020 22:07	23/12/2020 12:07	23/12/2020 22:07	9,99	1	9,99	CHI
202012133455	INHUMAS	IN12324564	ARACU	23/12/2020 12:08	24/12/2020 13:00	23/12/2020 12:08	24/12/2020 13:00	24,86	2	49,71	CHI
202012132603	ITAPIRAPUA	IU12070519	MATRINCHA	23/12/2020 12:09	23/12/2020 15:17	23/12/2020 12:09	23/12/2020 15:17	3,13	129	404,06	CHI
202012132546	ITAPURANGA	IK16408580	ITAPURANGA	23/12/2020 12:10	23/12/2020 16:16	23/12/2020 12:10	23/12/2020 16:16	4,11	2245	9236,30	CHI
202012133541	CORUMBAIBA	CI12392157	VILA CORUMBA	23/12/2020 12:10	24/12/2020 10:41	23/12/2020 12:10	24/12/2020 10:41	22,51	8	180,05	CHI
202012132492	ARAGUAPAZ	AZ12193702	GOIAS	23/12/2020 12:11	24/12/2020 09:53	23/12/2020 12:11	24/12/2020 09:53	21,70	2	43,40	CHI
202012132494	PARANAIGUARA	PC12239015	QUIRINOPOLIS	23/12/2020 12:11	23/12/2020 14:16	23/12/2020 12:11	23/12/2020 14:16	2,10	1	2,10	CHI
202012132780	ALTO HORIZONTE	AJ12232302	SANTA TEREZINHA	23/12/2020 12:11	23/12/2020 15:36	23/12/2020 12:11	23/12/2020 15:36	3,41	9	30,65	CHI
202012132780	CAMPOS VERDES	AJ12232302	SANTA TEREZINHA	23/12/2020 12:11	23/12/2020 15:36	23/12/2020 12:11	23/12/2020 15:36	3,41	5	17,03	CHI
202012132856	SAO MIGUEL DO PASSA QUATRO	SV12241056	VIANOPOLIS	23/12/2020 12:11	23/12/2020 16:10	23/12/2020 12:11	23/12/2020 16:10	3,98	9	35,83	CHI
202012132856	SILVANIA	SV12241056	VIANOPOLIS	23/12/2020 12:11	23/12/2020 16:10	23/12/2020 12:11	23/12/2020 16:10	3,98	3	11,94	CHI
202012133448	HIDROLANDIA	HD12000067	INDEPENDENCIA S1	23/12/2020 12:12	23/12/2020 17:07	23/12/2020 12:12	23/12/2020 17:07	4,91	11	54,03	CHI
202012133448	ARAGOIANIA	HD12000067	INDEPENDENCIA S1	23/12/2020 12:12	23/12/2020 17:07	23/12/2020 12:12	23/12/2020 17:07	4,91	5	24,56	CHI
202012132537	ARUANA	03960214	NOVA CRIXAS	23/12/2020 12:15	27/12/2020 01:59	23/12/2020 12:15	23/12/2020 14:11	1,93	26	50,29	CHI
202012132537	NOVA CRIXAS	03960214	NOVA CRIXAS	23/12/2020 12:15	27/12/2020 01:59	23/12/2020 12:15	23/12/2020 14:11	1,93	90	174,07	CHI
202012132537	NOVA CRIXAS	03960214	NOVA CRIXAS	23/12/2020 12:15	27/12/2020 01:59	23/12/2020 14:16	23/12/2020 15:15	1,00	48	47,80	CHI
202012132537	ARUANA	03960214	NOVA CRIXAS	23/12/2020 12:15	27/12/2020 01:59	23/12/2020 14:16	23/12/2020 17:47	3,51	26	91,34	CHI
202012132537	NOVA CRIXAS	03960214	NOVA CRIXAS	23/12/2020 12:15	27/12/2020 01:59	23/12/2020 14:16	23/12/2020 17:47	3,51	16	56,21	CHI

202012132537	NOVA CRIXAS	03960214	NOVA CRIXAS	23/12/2020 12:15	27/12/2020 01:59	23/12/2020 14:16	25/12/2020 22:56	56,67	1	56,67	CHI
202012132537	NOVA CRIXAS	NA12201789	NOVA CRIXAS	23/12/2020 12:15	27/12/2020 01:59	25/12/2020 23:02	26/12/2020 00:23	1,36	1	1,36	CHI
202012132537	NOVA CRIXAS	NA12201789	NOVA CRIXAS	23/12/2020 12:15	27/12/2020 01:59	26/12/2020 19:31	26/12/2020 21:41	2,17	1	2,17	CHI
202012132537	NOVA CRIXAS	03960214	NOVA CRIXAS	23/12/2020 12:15	27/12/2020 01:59	23/12/2020 14:16	26/12/2020 22:01	79,75	26	2073,53	CHI
202012132537	NOVA CRIXAS	03960214	NOVA CRIXAS	23/12/2020 12:15	27/12/2020 01:59	23/12/2020 14:16	26/12/2020 23:15	80,99	1	80,99	CHI
202012132537	NOVA CRIXAS	NA21198488	NOVA CRIXAS	23/12/2020 12:15	27/12/2020 01:59	26/12/2020 23:20	27/12/2020 01:59	2,66	1	2,66	CHI
202012132523	FORMOSA	FA12204759	ITIQUEIRA	23/12/2020 12:16	24/12/2020 03:09	23/12/2020 12:16	24/12/2020 03:09	14,88	262	3899,21	CHI
202012132523	VILA BOA	FA12204759	ITIQUEIRA	23/12/2020 12:16	24/12/2020 03:09	23/12/2020 12:16	24/12/2020 03:09	14,88	2	29,76	CHI
202012132545	ITUMBIARA	IT12352589	PARANAIBA	23/12/2020 12:21	23/12/2020 12:21	23/12/2020 12:21	23/12/2020 22:46	10,41	2	20,83	CHI
202012132652	PADRE BERNARDO	PB12376785RE	PADRE BERNARDO	23/12/2020 12:24	23/12/2020 15:16	23/12/2020 12:24	23/12/2020 15:16	2,86	43	122,93	CHI
202012132919	JARAGUA	JA12029022	JARAGUA	23/12/2020 12:24	23/12/2020 17:33	23/12/2020 12:24	23/12/2020 17:33	5,15	156	802,88	CHI
202012132568	NOVA AMERICA	NM12334445	RUBIATABA	23/12/2020 12:25	23/12/2020 18:55	23/12/2020 12:25	23/12/2020 18:55	6,50	1	6,50	CHI
202012132570	SANTA CRUZ DE GOIAS	PJ12212206	CALDAS NOVAS S1	23/12/2020 12:25	24/12/2020 01:58	23/12/2020 12:25	24/12/2020 01:58	13,54	1	13,54	CHI
202012132574	NOVO GAMA	NU11313729	MARAJOARA	23/12/2020 12:26	23/12/2020 15:20	23/12/2020 12:26	23/12/2020 15:20	2,89	119	343,74	CHI
202012132582	QUIRINOPOLIS	QI21000027	QUIRINOPOLIS	23/12/2020 12:27	23/12/2020 14:05	23/12/2020 12:27	23/12/2020 14:05	1,62	1	1,62	CHI
202012132604	CAIAPONIA	CP12155495	CAIAPONIA	23/12/2020 12:28	23/12/2020 14:48	23/12/2020 12:28	23/12/2020 14:48	2,32	10	23,19	CHI
202012133033	SILVANIA	SV12202389	DAIA S2	23/12/2020 12:29	23/12/2020 20:32	23/12/2020 12:29	23/12/2020 20:32	8,04	26	208,98	CHI
202012132639	JESUPOLIS	SF12066036	SAO FRANCISCO DE GOIAS	23/12/2020 12:30	23/12/2020 14:02	23/12/2020 12:30	23/12/2020 14:02	1,53	16	24,44	CHI
202012133138	CRISTALINA	KR12250016	PAMPLONA	23/12/2020 12:31	23/12/2020 16:47	23/12/2020 12:31	23/12/2020 16:47	4,26	27	115,07	CHI
202012132605	PIRES DO RIO	PR21409078	PIRES DO RIO S2	23/12/2020 12:33	23/12/2020 15:28	23/12/2020 12:33	23/12/2020 15:28	2,92	1	2,92	CHI
202012132626	MONTIVIDIU	MV12226282	MONTIVIDIU T	23/12/2020 12:36	23/12/2020 22:03	23/12/2020 12:36	23/12/2020 22:03	9,45	1	9,45	CHI
202012132641	CALDAS NOVAS	760356282	SERRA DE CALDAS	23/12/2020 12:39	24/12/2020 02:01	23/12/2020 12:39	24/12/2020 02:01	13,37	1	13,37	CHI
202012132651	CROMINIA	CQ12293010	ROCHEDO	23/12/2020 12:41	23/12/2020 18:44	23/12/2020 12:41	23/12/2020 18:44	6,05	4	24,20	CHI
202012134586	ABADIA DE GOIAS	GN16409677	CARAJAS S1	23/12/2020 12:43	24/12/2020 02:10	23/12/2020 23:58	24/12/2020 00:08	0,18	2	0,36	CHI
202012134586	ABADIA DE GOIAS	GN16409629	CARAJAS S1	23/12/2020 12:43	24/12/2020 02:10	23/12/2020 12:43	24/12/2020 02:10	13,45	5	67,23	CHI
202012134586	ABADIA DE GOIAS	GN16409629	CARAJAS S1	23/12/2020 12:43	24/12/2020 02:10	24/12/2020 00:13	24/12/2020 02:10	1,94	20	38,88	CHI
202012132675	SERRANOPOLIS	SX12260517	JATAI S1	23/12/2020 12:46	23/12/2020 19:22	23/12/2020 12:46	23/12/2020 19:22	6,59	2	13,19	CHI
202012133150	HEITORAI	HE12158782	ITAPURANGA	23/12/2020 12:47	23/12/2020 14:59	23/12/2020 12:47	23/12/2020 14:59	2,19	4	8,77	CHI
202012133150	ITAPURANGA	HE12158782	ITAPURANGA	23/12/2020 12:47	23/12/2020 14:59	23/12/2020 12:47	23/12/2020 14:59	2,19	16	35,09	CHI
202012132970	ITUMBIARA	BG12273858	ITUMBIARA VELHA S2	23/12/2020 12:48	24/12/2020 07:38	23/12/2020 12:48	24/12/2020 07:38	18,83	14	263,65	CHI
202012132689	CATALAO	CT12103631	CATALAO S1	23/12/2020 12:49	24/12/2020 04:16	23/12/2020 12:49	24/12/2020 04:16	15,43	8	123,47	CHI
202012137549	ARAGUAPAZ	AZ12234927	GOIAS	23/12/2020 12:49	24/12/2020 11:49	23/12/2020 12:49	24/12/2020 11:49	22,99	1	22,99	CHI
202012133309	CRISTALINA	KR12168476	CRISTALINA S2	23/12/2020 12:50	23/12/2020 23:07	23/12/2020 12:50	23/12/2020 18:24	5,56	19	105,60	CHI
202012133309	CRISTALINA	KR12168476	CRISTALINA S2	23/12/2020 12:50	23/12/2020 23:07	23/12/2020 12:50	23/12/2020 23:07	10,27	10	102,75	CHI
202012132712	COCALZINHO DE GOIAS	ZN12376728	AGUAS LINDAS DE GOIAS S2	23/12/2020 12:55	24/12/2020 01:30	23/12/2020 12:55	24/12/2020 01:30	12,59	17	214,09	CHI
202012132743	ITAJA	IM12148585	CACHOEIRA ALTA	23/12/2020 13:02	23/12/2020 17:31	23/12/2020 13:02	23/12/2020 17:31	4,47	11	49,16	CHI
202012132745	CORUMBAIBA	CI12062859	VILA CORUMBA	23/12/2020 13:03	23/12/2020 16:38	23/12/2020 13:03	23/12/2020 16:38	3,58	20	71,61	CHI
202012132790	SAO LUIS DE MONTES BELOS	SL12049625	SAO LUIZ DOS MONTES BELOS	23/12/2020 13:10	23/12/2020 16:22	23/12/2020 13:10	23/12/2020 16:22	3,19	1	3,19	CHI
202012133049	SANTA HELENA DE GOIAS	SH12247775	SANTA HELENA S1	23/12/2020 13:10	23/12/2020 19:48	23/12/2020 13:10	23/12/2020 19:48	6,62	2	13,24	CHI
202012132793	AGUA LIMPA	AL21113201	VILA CORUMBA	23/12/2020 13:11	24/12/2020 02:45	23/12/2020 13:11	24/12/2020 02:45	13,56	1	13,56	CHI
202012132801	FLORES DE GOIAS	FB12245566	IACIARA S2	23/12/2020 13:12	23/12/2020 14:54	23/12/2020 13:12	23/12/2020 14:54	1,70	73	124,10	CHI
202012132801	SITIO D ABADIA	FB12245566	IACIARA S2	23/12/2020 13:12	23/12/2020 14:54	23/12/2020 13:12	23/12/2020 14:54	1,70	39	66,30	CHI
202012132803	ANAPOLIS	10028066160	DAIA S1	23/12/2020 13:12	24/12/2020 04:00	23/12/2020 13:12	24/12/2020 04:00	14,81	1	14,81	CHI
202012132843	URUTAI	UT12384509	URUTAI	23/12/2020 13:15	23/12/2020 20:22	23/12/2020 13:15	23/12/2020 20:22	7,12	2	14,24	CHI
202012133036	PETROLINA DE GOIAS	PG12238128	PETROLINA	23/12/2020 13:15	23/12/2020 18:31	23/12/2020 13:15	23/12/2020 18:31	5,25	12	63,02	CHI
202012133112	PIRANHAS	DV12086880LD	CAIAPONIA	23/12/2020 13:15	23/12/2020 22:16	23/12/2020 13:15	23/12/2020 22:16	9,01	77	693,86	CHI
202012133112	DOVERLANDIA	DV12086880LD	CAIAPONIA	23/12/2020 13:15	23/12/2020 22:16	23/12/2020 13:15	23/12/2020 22:16	9,01	2	18,02	CHI
202012133112	CAIAPONIA	DV12086880LD	CAIAPONIA	23/12/2020 13:15	23/12/2020 22:16	23/12/2020 13:15	23/12/2020 22:16	9,01	44	396,49	CHI
202012133112	CAIAPONIA	DV12086880LD	CAIAPONIA	23/12/2020 13:15	23/12/2020 22:16	23/12/2020 20:13	23/12/2020 22:16	2,05	101	207,05	CHI
202012133112	DOVERLANDIA	DV12086880LD	CAIAPONIA	23/12/2020 13:15	23/12/2020 22:16	23/12/2020 20:13	23/12/2020 22:16	2,05	7	14,35	CHI
202012132862	CRISTALINA	KR21328707	CRISTALINA S1	23/12/2020 13:17	23/12/2020 14:00	23/12/2020 13:17	23/12/2020 14:00	0,71	2	1,42	CHI

202012132868	LUZIANIA	LZ21344836	MARAJOARA	23/12/2020 13:17	23/12/2020 16:22	23/12/2020 13:17	23/12/2020 16:22	3,09	5	15,46	CHI
202012132991	CACHOEIRA ALTA	CA12074128	CACHOEIRA ALTA	23/12/2020 13:17	23/12/2020 16:17	23/12/2020 13:17	23/12/2020 16:17	3,00	5	14,99	CHI
202012134919	SANTA HELENA DE GOIAS	SH12301270	ACREUNA	23/12/2020 13:17	23/12/2020 23:20	23/12/2020 13:17	23/12/2020 23:20	10,05	3	30,14	CHI
202012132895	CRIXAS	RB12039306	RUBIATABA	23/12/2020 13:21	23/12/2020 17:17	23/12/2020 13:21	23/12/2020 17:17	3,92	1	3,92	CHI
202012132920	SAO JOAO D ALIANCA	02160444	SAO JOAO D ALIANCA	23/12/2020 13:21	23/12/2020 21:07	23/12/2020 13:21	23/12/2020 15:55	2,57	30	76,96	CHI
202012132920	AGUA FRIA DE GOIAS	02160444	SAO JOAO D ALIANCA	23/12/2020 13:21	23/12/2020 21:07	23/12/2020 13:21	23/12/2020 15:55	2,57	28	71,83	CHI
202012132920	AGUA FRIA DE GOIAS	02160444	SAO JOAO D ALIANCA	23/12/2020 13:21	23/12/2020 21:07	23/12/2020 13:21	23/12/2020 21:07	7,78	43	334,55	CHI
202012132898	AGUAS LINDAS DE GOIAS	LA11060367	AGUAS LINDAS DE GOIAS S1	23/12/2020 13:22	23/12/2020 16:24	23/12/2020 13:22	23/12/2020 16:24	3,03	22	66,72	CHI
202012132930	AGUA FRIA DE GOIAS	02160434	SAO JOAO D ALIANCA	23/12/2020 13:22	23/12/2020 13:31	23/12/2020 13:22	23/12/2020 13:31	0,14	90	12,37	CHI
202012132930	NIQUELANDIA	02160434	SAO JOAO D ALIANCA	23/12/2020 13:22	23/12/2020 13:31	23/12/2020 13:22	23/12/2020 13:31	0,14	215	29,56	CHI
202012132930	SAO JOAO D ALIANCA	02160434	SAO JOAO D ALIANCA	23/12/2020 13:22	23/12/2020 13:31	23/12/2020 13:22	23/12/2020 13:31	0,14	124	17,05	CHI
202012132925	VALPARAISO DE GOIAS	VA12335862	PACAEMBU S2	23/12/2020 13:26	23/12/2020 15:15	23/12/2020 13:26	23/12/2020 15:15	1,81	65	117,60	CHI
202012132934	SENADOR CANEDO	SW12251907	SENADOR CANEDO	23/12/2020 13:27	23/12/2020 17:25	23/12/2020 13:27	23/12/2020 17:25	3,96	558	2209,22	CHI
202012132934	GOIANIA	SW12251907	SENADOR CANEDO	23/12/2020 13:27	23/12/2020 17:25	23/12/2020 13:27	23/12/2020 17:25	3,96	2	7,92	CHI
202012132938	IPAMERI	IP12112268	PIRES DO RIO S2	23/12/2020 13:27	24/12/2020 17:15	23/12/2020 13:27	23/12/2020 22:36	9,15	12	109,74	CHI
202012132938	IPAMERI	IP12112268	PIRES DO RIO S2	23/12/2020 13:27	24/12/2020 17:15	23/12/2020 13:27	24/12/2020 17:15	27,79	8	222,28	CHI
202012132938	IPAMERI	IP12112268	PIRES DO RIO S2	23/12/2020 13:27	24/12/2020 17:15	23/12/2020 22:39	24/12/2020 17:15	18,60	12	223,17	CHI
202012133198	GUARANI DE GOIAS	GY12267998	IACIARA S1	23/12/2020 13:27	23/12/2020 18:03	23/12/2020 13:27	23/12/2020 18:03	4,59	16	73,37	CHI
202012132946	MINEIROS	MY12248456	PARQUE DAS EMAS	23/12/2020 13:29	24/12/2020 13:36	23/12/2020 13:29	24/12/2020 13:36	24,10	1	24,10	CHI
202012132950	SANTO ANTONIO DO DESCOBERTO	SN12388639	ALEXANIA	23/12/2020 13:31	23/12/2020 16:13	23/12/2020 13:31	23/12/2020 16:13	2,69	7	18,86	CHI
202012133500	OURO VERDE DE GOIAS	OV12012290	INHUMAS S1	23/12/2020 13:31	23/12/2020 18:30	23/12/2020 13:31	23/12/2020 18:30	4,98	5	24,90	CHI
202012132857	VIANOPOLIS	VN21117156	VIANOPOLIS	23/12/2020 13:32	23/12/2020 22:00	23/12/2020 13:32	23/12/2020 22:00	8,46	2	16,92	CHI
202012132965	GOIAS	GS12162479	GOIAS	23/12/2020 13:33	23/12/2020 16:06	23/12/2020 13:33	23/12/2020 16:06	2,55	2	5,10	CHI
202012132972	GOIANIA	GN12050944	CARAJAS S1	23/12/2020 13:34	23/12/2020 16:07	23/12/2020 13:34	23/12/2020 16:07	2,55	1	2,55	CHI
202012132978	MINEIROS	1390066116	PARQUE DAS EMAS	23/12/2020 13:35	24/12/2020 08:49	23/12/2020 13:35	24/12/2020 08:49	19,23	1	19,23	CHI
202012132993	DIORAMA	DI12028436	ARENOPOLIS	23/12/2020 13:35	23/12/2020 17:10	23/12/2020 13:35	23/12/2020 17:10	3,60	3	10,80	CHI
202012132993	MONTES CLAROS DE GOIAS	DI12028436	ARENOPOLIS	23/12/2020 13:35	23/12/2020 17:10	23/12/2020 13:35	23/12/2020 17:10	3,60	13	46,79	CHI
202012133233	GOIAS	GS12073660	MATRINCHA	23/12/2020 13:35	26/12/2020 00:05	23/12/2020 13:35	25/12/2020 15:22	49,78	6	298,68	CHI
202012133233	GOIAS	GS12073660	MATRINCHA	23/12/2020 13:35	26/12/2020 00:05	23/12/2020 13:35	25/12/2020 20:51	55,27	1	55,27	CHI
202012133233	GOIAS	GS12073660	MATRINCHA	23/12/2020 13:35	26/12/2020 00:05	23/12/2020 13:35	25/12/2020 21:35	56,00	1	56,00	CHI
202012133233	GOIAS	GS12073660	MATRINCHA	23/12/2020 13:35	26/12/2020 00:05	23/12/2020 13:35	25/12/2020 22:36	57,01	4	228,05	CHI
202012133233	GOIAS	GS12073660	MATRINCHA	23/12/2020 13:35	26/12/2020 00:05	23/12/2020 13:35	26/12/2020 00:05	58,50	1	58,50	CHI
202012133678	NIQUELANDIA	NQ12371855RE	BARRO ALTO	23/12/2020 13:36	25/12/2020 15:42	23/12/2020 13:36	24/12/2020 10:02	20,43	1	20,43	CHI
202012133678	NIQUELANDIA	NQ12371855RE	BARRO ALTO	23/12/2020 13:36	25/12/2020 15:42	23/12/2020 13:36	24/12/2020 11:10	21,57	15	323,57	CHI
202012133678	NIQUELANDIA	NQ12371855RE	BARRO ALTO	23/12/2020 13:36	25/12/2020 15:42	24/12/2020 18:27	24/12/2020 19:46	1,31	15	19,60	CHI
202012133678	NIQUELANDIA	NQ12371855RE	BARRO ALTO	23/12/2020 13:36	25/12/2020 15:42	23/12/2020 13:36	24/12/2020 23:25	33,81	31	1048,20	CHI
202012133678	NIQUELANDIA	NQ12371855RE	BARRO ALTO	23/12/2020 13:36	25/12/2020 15:42	24/12/2020 23:48	25/12/2020 00:43	0,92	15	13,83	CHI
202012133678	NIQUELANDIA	NQ13364088	BARRO ALTO	23/12/2020 13:36	25/12/2020 15:42	24/12/2020 23:48	25/12/2020 12:43	12,92	30	387,49	CHI
202012133678	NIQUELANDIA	NQ12371855RE	BARRO ALTO	23/12/2020 13:36	25/12/2020 15:42	23/12/2020 13:36	25/12/2020 13:07	47,52	27	1282,95	CHI
202012133678	MIMOSO DE GOIAS	NQ12371855RE	BARRO ALTO	23/12/2020 13:36	25/12/2020 15:42	23/12/2020 13:36	25/12/2020 13:07	47,52	4	190,07	CHI
202012133678	NIQUELANDIA	NQ12371855RE	BARRO ALTO	23/12/2020 13:36	25/12/2020 15:42	23/12/2020 13:36	25/12/2020 13:33	47,94	168	8054,53	CHI
202012133678	NIQUELANDIA	NQ1221687	BARRO ALTO	23/12/2020 13:36	25/12/2020 15:42	24/12/2020 23:48	25/12/2020 15:42	15,91	1	15,91	CHI
202012133653	NOVO BRASIL	NB12378883	JUSSARA	23/12/2020 13:37	24/12/2020 12:53	23/12/2020 13:37	24/12/2020 12:53	23,26	5	116,30	CHI
202012132996	FIRMINOPOLIS	FR12005240	FIRMINOPOLIS S1	23/12/2020 13:38	23/12/2020 15:14	23/12/2020 13:38	23/12/2020 15:14	1,59	2	3,17	CHI
202012133003	CARMO DO RIO VERDE	IK12305640	ITAPURANGA	23/12/2020 13:40	24/12/2020 08:43	23/12/2020 13:40	24/12/2020 08:43	19,04	4	76,18	CHI
202012133005	MARA ROSA	MQ12187776	MARA ROSA	23/12/2020 13:40	24/12/2020 16:27	23/12/2020 13:40	24/12/2020 16:27	26,78	4	107,12	CHI
202012133237	MOZARLANDIA	NA12084403	MOZARLANDIA	23/12/2020 13:40	23/12/2020 17:39	23/12/2020 13:40	23/12/2020 17:39	3,98	2	7,96	CHI
202012133237	NOVA CRIXAS	NA12084403	MOZARLANDIA	23/12/2020 13:40	23/12/2020 17:39	23/12/2020 13:40	23/12/2020 17:39	3,98	5	19,90	CHI
202012133378	BURITINOPOLIS	SU12301950RE	SANTA RITA DO ARAGUAIA	23/12/2020 13:40	23/12/2020 19:03	23/12/2020 13:40	23/12/2020 19:03	5,37	1	5,37	CHI
202012133378	SANTA RITA DO ARAGUAIA	SU12301950RE	SANTA RITA DO ARAGUAIA	23/12/2020 13:40	23/12/2020 19:03	23/12/2020 13:40	23/12/2020 19:03	5,37	22	118,23	CHI
202012133009	GOUVELANDIA	QI32107357	QUIRINOPOLIS	23/12/2020 13:42	23/12/2020 17:58	23/12/2020 13:42	23/12/2020 17:58	4,27	1	4,27	CHI

202012135425	MINEIROS	PW10406624	PARQUE DAS EMAS	23/12/2020 13:46	24/12/2020 09:24	23/12/2020 13:46	24/12/2020 09:24	19,65	62	1218,08	CHI
202012135425	PORTELANDIA	PW10406624	PARQUE DAS EMAS	23/12/2020 13:46	24/12/2020 09:24	23/12/2020 13:46	24/12/2020 09:24	19,65	3	58,94	CHI
202012133042	CORUMBA DE GOIAS	CB12362257	CORUMBA	23/12/2020 13:48	24/12/2020 13:53	23/12/2020 13:48	24/12/2020 13:53	24,07	4	96,28	CHI
202012133063	GUAPO	GA12008543	GUAPO S2	23/12/2020 13:53	23/12/2020 20:43	23/12/2020 13:53	23/12/2020 20:43	6,83	29	198,07	CHI
202012133063	CAMPESTRE DE GOIAS	GA12008543	GUAPO S2	23/12/2020 13:53	23/12/2020 20:43	23/12/2020 13:53	23/12/2020 20:43	6,83	12	81,96	CHI
202012133302	MIMOSO DE GOIAS	MJ18071960FS	PADRE BERNARDO	23/12/2020 13:55	23/12/2020 19:08	23/12/2020 13:55	23/12/2020 19:08	5,21	160	833,38	CHI
202012133302	NIQUELANDIA	MJ18071960FS	PADRE BERNARDO	23/12/2020 13:55	23/12/2020 19:08	23/12/2020 13:55	23/12/2020 19:08	5,21	1	5,21	CHI
202012135209	INHUMAS	IN12012916	INHUMAS S1	23/12/2020 13:55	23/12/2020 23:49	23/12/2020 13:55	23/12/2020 23:49	9,89	7	69,21	CHI
202012133351	IACIARA	IA12262204	IACIARA S2	23/12/2020 13:57	23/12/2020 18:32	23/12/2020 13:57	23/12/2020 18:32	4,57	10	45,73	CHI
202012133104	FORMOSA	FA12394151	ITUIQUIRA	23/12/2020 14:00	23/12/2020 23:39	23/12/2020 14:00	23/12/2020 23:39	9,65	2	19,29	CHI
202012133111	MINEIROS	MY21348895	PARQUE DAS EMAS	23/12/2020 14:01	23/12/2020 21:58	23/12/2020 14:01	23/12/2020 21:58	7,96	1	7,96	CHI
202012133164	CALDAS NOVAS	CN11029472	SERRA DE CALDAS	23/12/2020 14:01	24/12/2020 00:14	23/12/2020 14:01	24/12/2020 00:14	10,20	94	958,93	CHI
202012133146	CABECEIRAS	10015726558	ITUIQUIRA	23/12/2020 14:05	23/12/2020 20:07	23/12/2020 14:05	23/12/2020 20:07	6,02	1	6,02	CHI
202012133159	PIRACANJUBA	CF12029889	CRISTIANOPOLIS	23/12/2020 14:07	24/12/2020 08:16	23/12/2020 14:07	24/12/2020 08:16	18,15	3	54,44	CHI
202012133167	ITAGUARU	JA12027826	JARAGUA	23/12/2020 14:09	24/12/2020 08:44	23/12/2020 14:09	24/12/2020 08:44	18,57	9	167,17	CHI
202012133167	JARAGUA	JA12027826	JARAGUA	23/12/2020 14:09	24/12/2020 08:44	23/12/2020 14:09	24/12/2020 08:44	18,57	18	334,35	CHI
202012133173	HEITORAI	HE12060931	ITAPURANGA	23/12/2020 14:10	23/12/2020 17:16	23/12/2020 14:10	23/12/2020 17:16	3,09	11	34,00	CHI
202012133288	CRIXAS	SG12291237	SANTA TEREZINHA	23/12/2020 14:11	23/12/2020 17:44	23/12/2020 14:11	23/12/2020 17:44	3,54	15	53,03	CHI
202012133288	GUARINOS	SG12291237	SANTA TEREZINHA	23/12/2020 14:11	23/12/2020 17:44	23/12/2020 14:11	23/12/2020 17:44	3,54	6	21,21	CHI
202012133329	JATAI	JT12234396	JATAI S1	23/12/2020 14:12	23/12/2020 17:38	23/12/2020 14:12	23/12/2020 17:38	3,42	3	10,27	CHI
202012133201	CORUMBA DE GOIAS	CB21061915	CORUMBA	23/12/2020 14:15	23/12/2020 15:59	23/12/2020 14:15	23/12/2020 15:59	1,72	2	3,45	CHI
202012133204	FAZENDA NOVA	FN12250941	JUSSARA	23/12/2020 14:16	24/12/2020 11:27	23/12/2020 14:16	24/12/2020 11:27	21,17	72	1524,48	CHI
202012133204	NOVO BRASIL	FN12250941	JUSSARA	23/12/2020 14:16	24/12/2020 11:27	23/12/2020 14:16	24/12/2020 11:27	21,17	2	42,35	CHI
202012134394	CRISTALINA	KR12184956	CRISTALINA S2	23/12/2020 14:17	23/12/2020 23:07	23/12/2020 14:17	23/12/2020 23:07	8,83	20	176,65	CHI
202012133468	FAINA	GS12220400	GOIAS	23/12/2020 14:21	24/12/2020 10:23	23/12/2020 14:21	24/12/2020 10:23	20,02	6	120,13	CHI
202012133468	GOIAS	GS12220400	GOIAS	23/12/2020 14:21	24/12/2020 10:23	23/12/2020 14:21	24/12/2020 10:23	20,02	53	1061,12	CHI
202012133234	PIRES DO RIO	PR21000081	PIRES DO RIO S1	23/12/2020 14:22	23/12/2020 17:18	23/12/2020 14:22	23/12/2020 17:18	2,93	1	2,93	CHI
202012133490	CAIAPONIA	PH12341859	PIRANHAS	23/12/2020 14:22	23/12/2020 16:32	23/12/2020 14:22	23/12/2020 16:32	2,16	7	15,13	CHI
202012133250	PIRES DO RIO	PR12265574	PIRES DO RIO S1	23/12/2020 14:24	23/12/2020 17:47	23/12/2020 14:24	23/12/2020 17:47	3,37	1	3,37	CHI
202012133266	CHAPADA DO CEU	DJ12341143	CHAPADAO DO CEU	23/12/2020 14:25	23/12/2020 16:36	23/12/2020 14:25	23/12/2020 16:36	2,17	1	2,17	CHI
202012133267	GOIANDIRA	GD12231471	CATALAO S1	23/12/2020 14:29	23/12/2020 16:53	23/12/2020 14:29	23/12/2020 16:53	2,39	5	11,97	CHI
202012133283	CRISTALINA	KR12321840	PAMPLONA	23/12/2020 14:31	23/12/2020 23:23	23/12/2020 14:31	23/12/2020 23:23	8,85	2	17,70	CHI
202012179453	PALMEIRAS DE GOIAS	PL21287719	PALMEIRAS	23/12/2020 14:34	23/12/2020 15:19	23/12/2020 14:34	23/12/2020 15:19	0,75	1	0,75	CHI
202012133298	SANTA TEREZINHA DE GOIAS	GG12181600	SANTA TEREZINHA	23/12/2020 14:35	23/12/2020 17:11	23/12/2020 14:35	23/12/2020 17:11	2,60	7	18,17	CHI
202012133614	PORTELANDIA	PW11341122	PARQUE DAS EMAS	23/12/2020 14:35	23/12/2020 20:32	23/12/2020 14:35	23/12/2020 20:32	5,96	55	327,82	CHI
202012133306	PIRENOPOLIS	PV21246336	SAO FRANCISCO DE GOIAS	23/12/2020 14:37	24/12/2020 12:00	23/12/2020 14:37	24/12/2020 12:00	21,39	1	21,39	CHI
202012133341	ITAPIRAPUA	10002498357	MATRINCHA	23/12/2020 14:43	25/12/2020 18:11	23/12/2020 14:43	25/12/2020 18:11	51,47	1	51,47	CHI
202012133673	COCALZINHO DE GOIAS	SN12246920	AGUAS LINDAS DE GOIAS S2	23/12/2020 14:43	23/12/2020 17:17	23/12/2020 14:43	23/12/2020 17:17	2,56	5	12,82	CHI
202012133673	SANTO ANTONIO DO DESCOBERTO	SN12246920	AGUAS LINDAS DE GOIAS S2	23/12/2020 14:43	23/12/2020 17:17	23/12/2020 14:43	23/12/2020 17:17	2,56	20	51,29	CHI
202012133344	ABADIANIA	AA12349441	ANAPOLIS UNIVERSITARIO S1	23/12/2020 14:44	23/12/2020 23:30	23/12/2020 22:07	23/12/2020 23:30	1,39	10	13,90	CHI
202012133344	GAMELEIRA DE GOIAS	AA12349441	ANAPOLIS UNIVERSITARIO S1	23/12/2020 14:44	23/12/2020 23:30	23/12/2020 22:07	23/12/2020 23:30	1,39	1	1,39	CHI
202012133347	PEROLANDIA	DP12325322	JATAI S1	23/12/2020 14:44	23/12/2020 17:22	23/12/2020 14:44	23/12/2020 17:22	2,63	1	2,63	CHI
202012133355	PIRES DO RIO	6445707	PIRES DO RIO S1	23/12/2020 14:46	23/12/2020 17:08	23/12/2020 14:46	23/12/2020 17:08	2,36	2	4,72	CHI
202012133396	VILA BOA	FB10410987	IACIARA S2	23/12/2020 14:48	23/12/2020 18:46	23/12/2020 14:48	23/12/2020 14:52	0,06	3	0,17	CHI
202012133396	SITIO D ABADIA	FB10410987	IACIARA S2	23/12/2020 14:48	23/12/2020 18:46	23/12/2020 14:48	23/12/2020 14:52	0,06	10	0,57	CHI
202012133396	FLORES DE GOIAS	FB10410987	IACIARA S2	23/12/2020 14:48	23/12/2020 18:46	23/12/2020 14:48	23/12/2020 14:52	0,06	982	55,92	CHI
202012133396	FORMOSA	FB10410987	IACIARA S2	23/12/2020 14:48	23/12/2020 18:46	23/12/2020 14:48	23/12/2020 14:52	0,06	1	0,06	CHI
202012133396	ALVORADA DO NORTE	00010414	IACIARA S2	23/12/2020 14:48	23/12/2020 18:46	23/12/2020 14:48	23/12/2020 17:20	2,52	56	141,31	CHI
202012133396	IACIARA	00010414	IACIARA S2	23/12/2020 14:48	23/12/2020 18:46	23/12/2020 14:48	23/12/2020 17:20	2,52	1	2,52	CHI
202012133396	FLORES DE GOIAS	FB10407015	IACIARA S2	23/12/2020 14:48	23/12/2020 18:46	23/12/2020 14:48	23/12/2020 18:11	3,39	41	138,85	CHI
202012133396	ALVORADA DO NORTE	FB10407015	IACIARA S2	23/12/2020 14:48	23/12/2020 18:46	23/12/2020 14:48	23/12/2020 18:11	3,39	89	301,41	CHI



202012133396	SITIO D ABADIA	FB10407015	IACIARA S2	23/12/2020 14:48	23/12/2020 18:46	23/12/2020 14:48	23/12/2020 18:11	3,39	27	91,44	CHI
202012133396	ALVORADA DO NORTE	AQ13344343	IACIARA S2	23/12/2020 14:48	23/12/2020 18:46	23/12/2020 14:48	23/12/2020 18:27	3,65	150	546,79	CHI
202012133396	SIMOLANDIA	AQ13344343	IACIARA S2	23/12/2020 14:48	23/12/2020 18:46	23/12/2020 14:48	23/12/2020 18:27	3,65	1	3,65	CHI
202012133396	SITIO D ABADIA	AQ13344346	IACIARA S2	23/12/2020 14:48	23/12/2020 18:46	23/12/2020 18:32	23/12/2020 18:46	0,24	27	6,40	CHI
202012133396	ALVORADA DO NORTE	AQ13344346	IACIARA S2	23/12/2020 14:48	23/12/2020 18:46	23/12/2020 18:32	23/12/2020 18:46	0,24	89	21,11	CHI
202012133396	FLORES DE GOIAS	AQ13344346	IACIARA S2	23/12/2020 14:48	23/12/2020 18:46	23/12/2020 18:32	23/12/2020 18:46	0,24	41	9,73	CHI
202012134361	PANAMA	PX12190957	CACHOEIRA DOURADA	23/12/2020 14:49	23/12/2020 21:34	23/12/2020 14:49	23/12/2020 21:34	6,74	7	47,17	CHI
202012133561	SANTO ANTONIO DO DESCOBERTO	AX12000057	ALEXANIA	23/12/2020 14:51	23/12/2020 23:17	23/12/2020 14:51	23/12/2020 23:17	8,43	1	8,43	CHI
202012133561	ALEXANIA	AX12000057	ALEXANIA	23/12/2020 14:51	23/12/2020 23:17	23/12/2020 14:51	23/12/2020 23:17	8,43	10	84,28	CHI
202012133406	BRITANIA	BT11043375	BRITANIA	23/12/2020 14:55	23/12/2020 19:00	23/12/2020 14:55	23/12/2020 19:00	4,07	196	798,70	CHI
202012133512	FAINA	FC12386403	GOIAS	23/12/2020 14:55	23/12/2020 20:25	23/12/2020 14:55	23/12/2020 20:25	5,50	4	21,99	CHI
202012133928	IPAMERI	IP12159928	CRISTALINA S2	23/12/2020 14:58	23/12/2020 17:48	23/12/2020 14:58	23/12/2020 17:48	2,82	5	14,09	CHI
202012133434	ACREUNA	EU12045110	ACREUNA	23/12/2020 15:01	24/12/2020 00:20	23/12/2020 15:01	24/12/2020 00:20	9,31	3	27,92	CHI
202012133435	ITAJA	IJ21392357	ITAJA S2	23/12/2020 15:01	23/12/2020 18:15	23/12/2020 15:01	23/12/2020 18:15	3,22	1	3,22	CHI
202012133441	PALMEIRAS DE GOIAS	PL12364761	PALMEIRAS	23/12/2020 15:02	23/12/2020 23:44	23/12/2020 20:28	23/12/2020 23:44	3,26	16	52,21	CHI
202012133441	PALMEIRAS DE GOIAS	PL12390265	PALMEIRAS	23/12/2020 15:02	23/12/2020 23:44	23/12/2020 15:02	23/12/2020 23:44	8,70	5	43,51	CHI
202012133600	SAO MIGUEL DO ARAGUAIA	SM12360519	SAO MIGUEL DO ARAGUAIA	23/12/2020 15:02	23/12/2020 21:08	23/12/2020 15:02	23/12/2020 21:08	6,09	2	12,17	CHI
202012133537	CAMPINACU	UC12197189	PORANGATU	23/12/2020 15:04	23/12/2020 17:37	23/12/2020 15:04	23/12/2020 17:37	2,55	68	173,14	CHI
202012133515	VARJAO	00370224	CEZARINA	23/12/2020 15:05	23/12/2020 19:18	23/12/2020 15:05	23/12/2020 17:04	1,97	11	21,67	CHI
202012133515	CEZARINA	00370224	CEZARINA	23/12/2020 15:05	23/12/2020 19:18	23/12/2020 15:05	23/12/2020 17:04	1,97	2300	4531,00	CHI
202012133515	VARJAO	00370224	CEZARINA	23/12/2020 15:05	23/12/2020 19:18	23/12/2020 15:08	23/12/2020 17:04	1,93	1	1,93	CHI
202012133515	INDIARA	00370224	CEZARINA	23/12/2020 15:05	23/12/2020 19:18	23/12/2020 15:05	23/12/2020 17:07	2,03	9	18,28	CHI
202012133515	PALMEIRAS DE GOIAS	00370224	CEZARINA	23/12/2020 15:05	23/12/2020 19:18	23/12/2020 15:05	23/12/2020 17:07	2,03	1	2,03	CHI
202012133515	CEZARINA	00370224	CEZARINA	23/12/2020 15:05	23/12/2020 19:18	23/12/2020 15:05	23/12/2020 17:07	2,03	718	1458,34	CHI
202012133515	CEZARINA	CZ16404917	CEZARINA	23/12/2020 15:05	23/12/2020 19:18	23/12/2020 15:08	23/12/2020 17:07	1,99	2	3,98	CHI
202012133515	CEZARINA	00370224	CEZARINA	23/12/2020 15:05	23/12/2020 19:18	23/12/2020 15:05	23/12/2020 19:18	4,21	1	4,21	CHI
202012133486	PEROLANDIA	DP12182220	JATAI S1	23/12/2020 15:12	23/12/2020 18:20	23/12/2020 15:12	23/12/2020 18:20	3,12	7	21,87	CHI
202012133492	TURVELANDIA	TD12025690	RIO DOS BOIS	23/12/2020 15:14	24/12/2020 03:54	23/12/2020 15:14	24/12/2020 03:54	12,67	2	25,33	CHI
202012133495	AMARALINA	LC12308828	MARA ROSA	23/12/2020 15:14	24/12/2020 08:25	23/12/2020 15:14	24/12/2020 08:25	17,17	2	34,35	CHI
202012133495	MARA ROSA	LC12308828	MARA ROSA	23/12/2020 15:14	24/12/2020 08:25	23/12/2020 15:14	24/12/2020 08:25	17,17	1	17,17	CHI
202012133519	CRISTALINA	KR12305271	CRISTALINA S2	23/12/2020 15:15	23/12/2020 19:15	23/12/2020 15:15	23/12/2020 19:15	3,99	5	19,93	CHI
202012133509	CAMPO ALEGRE DE GOIAS	CM12192738RE	CAMPO ALEGRE DE GOIAS	23/12/2020 15:17	23/12/2020 18:16	23/12/2020 15:17	23/12/2020 18:16	2,97	51	151,63	CHI
202012134859	FLORES DE GOIAS	FB12352554	FLORES DE GOIAS	23/12/2020 15:18	23/12/2020 21:36	23/12/2020 15:18	23/12/2020 21:36	6,30	120	755,93	CHI
202012133157	CALDAS NOVAS	CN11040988	SERRA DE CALDAS	23/12/2020 15:19	23/12/2020 17:38	23/12/2020 15:19	23/12/2020 17:38	2,31	90	207,45	CHI
202012133518	CORUMBA DE GOIAS	CB12078301	CORUMBA	23/12/2020 15:19	24/12/2020 11:13	23/12/2020 15:19	24/12/2020 11:13	19,90	4	79,59	CHI
202012133661	PALMEIRAS DE GOIAS	PL12085231	PALMEIRAS	23/12/2020 15:19	23/12/2020 18:10	23/12/2020 15:19	23/12/2020 18:10	2,85	51	145,34	CHI
202012134463	APARECIDA DE GOIANIA	AP12000049	CEPAIGO S1	23/12/2020 15:19	24/12/2020 09:00	23/12/2020 15:19	24/12/2020 09:00	17,67	40	706,98	CHI
202012133546	GOIANIA	17223696	MEIA PONTE	23/12/2020 15:25	23/12/2020 16:40	23/12/2020 15:25	23/12/2020 16:40	1,25	1	1,25	CHI
202012133999	SAO MIGUEL DO ARAGUAIA	SM12013036	SAO MIGUEL DO ARAGUAIA	23/12/2020 15:25	23/12/2020 23:12	23/12/2020 15:25	23/12/2020 23:12	7,77	22	170,95	CHI
202012134220	MINEIROS	MY12252571	PARQUE DAS EMAS	23/12/2020 15:25	24/12/2020 12:24	23/12/2020 15:25	24/12/2020 12:24	20,97	3	62,91	CHI
202012133555	NOVA CRIXAS	NA12086286	NOVA CRIXAS	23/12/2020 15:26	23/12/2020 18:13	23/12/2020 15:26	23/12/2020 18:13	2,78	9	25,05	CHI
202012133594	SILVANIA	SV12382773	DAIA S2	23/12/2020 15:26	23/12/2020 21:56	23/12/2020 15:26	23/12/2020 21:56	6,49	10	64,93	CHI
202012133659	ITAPIRAPUA	IU12070519	MATRINCHA	23/12/2020 15:30	24/12/2020 16:20	23/12/2020 15:30	24/12/2020 16:20	24,83	129	3203,50	CHI
202012133584	ADELANDIA	DN12021725	FIRMINOPOLIS S2	23/12/2020 15:31	23/12/2020 19:21	23/12/2020 15:31	23/12/2020 19:21	3,83	2	7,65	CHI
202012133609	DOVERLANDIA	DV12188456	CAIAPONIA	23/12/2020 15:36	24/12/2020 19:27	23/12/2020 15:36	24/12/2020 19:27	27,83	2	55,67	CHI
202012133633	CIDADE OCIDENTAL	00380454	MARAJOARA	23/12/2020 15:36	23/12/2020 15:43	23/12/2020 15:36	23/12/2020 15:43	0,11	72	7,62	CHI
202012133633	CIDADE OCIDENTAL	00380454	MARAJOARA	23/12/2020 15:36	23/12/2020 15:43	23/12/2020 15:36	23/12/2020 15:43	0,11	1	0,11	CHI
202012133633	CIDADE OCIDENTAL	00380454	MARAJOARA	23/12/2020 15:36	23/12/2020 15:43	23/12/2020 15:36	23/12/2020 15:43	0,11	731	77,36	CHI
202012133633	CIDADE OCIDENTAL	00380454	MARAJOARA	23/12/2020 15:36	23/12/2020 15:43	23/12/2020 15:36	23/12/2020 15:43	0,11	2794	295,70	CHI
202012133615	JUSSARA	RN12090833	JUSSARA	23/12/2020 15:37	23/12/2020 19:02	23/12/2020 15:37	23/12/2020 19:02	3,40	2	6,81	CHI
202012133964	UIRAPURU	UP12391846	SANTA TEREZINHA	23/12/2020 15:38	23/12/2020 20:24	23/12/2020 15:38	23/12/2020 20:24	4,75	9	42,78	CHI

202012135176	AMARALINA	LC12230319	NOVA CRIXAS	23/12/2020 15:39	24/12/2020 10:45	23/12/2020 15:39	24/12/2020 10:45	19,10	3	57,31	CHI
202012133634	CATALAO	CT12333388	CATALAO S1	23/12/2020 15:41	23/12/2020 22:23	23/12/2020 15:41	23/12/2020 22:23	6,70	1	6,70	CHI
202012133657	ARENOPOLIS	AY21024546	PIRANHAS	23/12/2020 15:45	24/12/2020 13:57	23/12/2020 15:45	24/12/2020 13:57	22,21	1	22,21	CHI
202012133664	ARUANA	AK12264829	MOZARLANDIA	23/12/2020 15:46	23/12/2020 18:40	23/12/2020 15:46	23/12/2020 18:40	2,89	32	92,52	CHI
202012133668	NOVA CRIXAS	NA12057420LD	MOZARLANDIA	23/12/2020 15:47	23/12/2020 21:37	23/12/2020 15:47	23/12/2020 21:37	5,83	39	227,32	CHI
202012133668	CRIXAS	NA12057420LD	MOZARLANDIA	23/12/2020 15:47	23/12/2020 21:37	23/12/2020 15:47	23/12/2020 21:37	5,83	1	5,83	CHI
202012133811	GOIATUBA	GT12044907	GOIATUBA S2	23/12/2020 15:49	23/12/2020 22:10	23/12/2020 15:49	23/12/2020 22:10	6,34	14	88,73	CHI
202012133686	SAO FRANCISCO DE GOIAS	PV21016178	SAO FRANCISCO DE GOIAS	23/12/2020 15:50	24/12/2020 11:10	23/12/2020 15:50	24/12/2020 11:10	19,33	1	19,33	CHI
202012134543	TURVELANDIA	TD12025737	RIO DOS BOIS	23/12/2020 15:50	23/12/2020 23:13	23/12/2020 15:50	23/12/2020 23:13	7,38	66	486,99	CHI
202012134543	SANTA HELENA DE GOIAS	TD12025737	RIO DOS BOIS	23/12/2020 15:50	23/12/2020 23:13	23/12/2020 15:50	23/12/2020 23:13	7,38	18	132,81	CHI
202012134543	ACREUNA	TD12025737	RIO DOS BOIS	23/12/2020 15:50	23/12/2020 23:13	23/12/2020 15:50	23/12/2020 23:13	7,38	26	191,84	CHI
202012133083	SERRANOPOLIS	SX12390596LD	JATAI S1	23/12/2020 15:51	24/12/2020 09:22	23/12/2020 15:51	24/12/2020 09:22	17,50	35	612,51	CHI
202012133693	SAO JOAO DA PARAUNA	RP12259184	FIRMINOPOLIS S2	23/12/2020 15:51	23/12/2020 19:52	23/12/2020 15:51	23/12/2020 19:52	4,01	4	16,04	CHI
202012133693	PALMINOPOLIS	RP12259184	FIRMINOPOLIS S2	23/12/2020 15:51	23/12/2020 19:52	23/12/2020 15:51	23/12/2020 19:52	4,01	2	8,02	CHI
202012133699	SAO DOMINGOS	SD12134715LD	SAO DOMINGOS	23/12/2020 15:53	23/12/2020 19:02	23/12/2020 15:53	23/12/2020 19:02	3,15	12	37,76	CHI
202012133704	CATALAO	CT12327323	CATALAO S1	23/12/2020 15:53	23/12/2020 18:16	23/12/2020 15:53	23/12/2020 18:16	2,37	3	7,10	CHI
202012133724	GOIANIA	GN11001556	GOIANIA LESTE S1	23/12/2020 15:57	23/12/2020 16:20	23/12/2020 15:57	23/12/2020 16:20	0,38	1	0,38	CHI
202012133725	ANAPOLIS	NR12009283	NEROPOLIS S2	23/12/2020 15:58	24/12/2020 12:59	23/12/2020 15:58	24/12/2020 12:59	21,00	4	84,02	CHI
202012133730	ITABERAI	IB12300060	ITABERAI S1	23/12/2020 16:00	23/12/2020 17:35	23/12/2020 16:00	23/12/2020 17:35	1,58	3	4,73	CHI
202012133955	PADRE BERNARDO	PB12275695	PADRE BERNARDO	23/12/2020 16:02	24/12/2020 11:05	23/12/2020 16:02	24/12/2020 11:05	19,04	6	114,25	CHI
202012133767	FIRMINOPOLIS	900010381	FIRMINOPOLIS S1	23/12/2020 16:03	23/12/2020 19:13	23/12/2020 16:03	23/12/2020 19:13	3,17	1	3,17	CHI
202012133778	CROMINIA	CQ21155504	PONTALINA	23/12/2020 16:06	24/12/2020 08:36	23/12/2020 16:06	24/12/2020 08:36	16,49	1	16,49	CHI
202012133792	MINEIROS	MY12296330	PARQUE DAS EMAS	23/12/2020 16:08	24/12/2020 13:21	23/12/2020 16:08	24/12/2020 13:21	21,21	3	63,64	CHI
202012135025	GOIAS	GK12220543	ITAPURANGA	23/12/2020 16:09	24/12/2020 09:18	23/12/2020 16:09	24/12/2020 09:18	17,14	11	188,56	CHI
202012135025	GUARAITA	GK12220543	ITAPURANGA	23/12/2020 16:09	24/12/2020 09:18	23/12/2020 16:09	24/12/2020 09:18	17,14	22	377,12	CHI
202012133992	PALMEIRAS DE GOIAS	PL12143287	PALMEIRAS	23/12/2020 16:10	23/12/2020 20:51	23/12/2020 16:10	23/12/2020 20:51	4,68	37	173,20	CHI
202012133816	NOVA CRIXAS	NA21381795	NOVA CRIXAS	23/12/2020 16:12	24/12/2020 17:30	23/12/2020 16:12	24/12/2020 15:29	23,27	1	23,27	CHI
202012133816	NOVA CRIXAS	NA21381795	NOVA CRIXAS	23/12/2020 16:12	24/12/2020 17:30	24/12/2020 17:00	24/12/2020 17:30	0,50	1	0,50	CHI
202012133879	SANTA HELENA DE GOIAS	SH12296128	IPEGUARI	23/12/2020 16:12	24/12/2020 01:44	23/12/2020 16:12	24/12/2020 01:44	9,54	4	38,15	CHI
202012133879	SANTA HELENA DE GOIAS	SH12296128	IPEGUARI	23/12/2020 16:12	24/12/2020 01:44	23/12/2020 16:12	24/12/2020 01:44	4,67	4	18,68	CHI
202012133965	SANTO ANTONIO DO DESCOBERTO	SN12290826	PACAEMBU S1	23/12/2020 16:14	23/12/2020 19:23	23/12/2020 16:14	23/12/2020 19:23	3,14	17	53,34	CHI
202012133965	NOVO GAMA	SN12290826	PACAEMBU S1	23/12/2020 16:14	23/12/2020 19:23	23/12/2020 16:14	23/12/2020 19:23	3,14	4	12,55	CHI
202012135134	PORANGATU	PO12394943	MARA ROSA	23/12/2020 16:16	24/12/2020 19:05	23/12/2020 16:16	24/12/2020 16:07	23,85	3	71,54	CHI
202012135134	PORANGATU	PO12394943	MARA ROSA	23/12/2020 16:16	24/12/2020 19:05	23/12/2020 16:16	24/12/2020 16:47	24,51	5	122,57	CHI
202012135134	BONOPOLIS	PO12394943	MARA ROSA	23/12/2020 16:16	24/12/2020 19:05	23/12/2020 16:16	24/12/2020 16:47	24,51	2	49,03	CHI
202012135134	PORANGATU	PO12394943	MARA ROSA	23/12/2020 16:16	24/12/2020 19:05	23/12/2020 16:16	24/12/2020 19:05	26,83	1	26,83	CHI
202012133997	FAZENDA NOVA	FN12060693	IPORA	23/12/2020 16:19	24/12/2020 08:11	23/12/2020 16:19	24/12/2020 08:11	15,86	11	174,41	CHI
202012133876	APARECIDA DE GOIANIA	AP21402802	CEPAIGO S1	23/12/2020 16:21	23/12/2020 19:36	23/12/2020 16:21	23/12/2020 19:36	3,24	1	3,24	CHI
202012133890	COCALZINHO DE GOIAS	ZN12104981	AGUAS LINDAS DE GOIAS S2	23/12/2020 16:24	23/12/2020 19:57	23/12/2020 16:24	23/12/2020 19:57	3,54	3	10,62	CHI
202012134070	SANTA RITA DO NOVO DESTINO	BF12287229	BARRO ALTO	23/12/2020 16:32	24/12/2020 07:49	23/12/2020 16:32	24/12/2020 07:49	15,28	7	106,93	CHI
202012133942	NOVO GAMA	NJ12389552	PACAEMBU S2	23/12/2020 16:36	23/12/2020 22:08	23/12/2020 16:36	23/12/2020 22:08	5,52	2	11,04	CHI
202012133946	CORUMBAIBA	CI21110130	VILA CORUMBA	23/12/2020 16:37	23/12/2020 21:20	23/12/2020 16:37	23/12/2020 21:20	4,71	1	4,71	CHI
202012134916	AGUA LIMPA	AL12075701	VILA CORUMBA	23/12/2020 16:39	24/12/2020 10:45	23/12/2020 16:39	24/12/2020 10:45	18,09	5	90,47	CHI
202012133994	CORUMBAIBA	CI12062859	VILA CORUMBA	23/12/2020 16:40	23/12/2020 19:17	23/12/2020 16:40	23/12/2020 19:17	2,61	20	52,11	CHI
202012134134	FORMOSA	TL12342352	SAO JOAO D ALIANCA	23/12/2020 16:40	24/12/2020 16:24	23/12/2020 16:40	23/12/2020 22:43	6,03	1	6,03	CHI
202012134134	AGUA FRIA DE GOIAS	TL12342352	SAO JOAO D ALIANCA	23/12/2020 16:40	24/12/2020 16:24	23/12/2020 16:40	23/12/2020 22:43	6,03	3	18,10	CHI
202012134134	AGUA FRIA DE GOIAS	TL12342352	SAO JOAO D ALIANCA	23/12/2020 16:40	24/12/2020 16:24	23/12/2020 16:40	24/12/2020 16:24	23,73	1	23,73	CHI
202012133998	PALMEIRAS DE GOIAS	PL12233352	PALMEIRAS	23/12/2020 16:47	23/12/2020 19:01	23/12/2020 16:47	23/12/2020 19:01	2,22	247	548,07	CHI
202012134002	CORUMBA DE GOIAS	CB12221423	CORUMBA	23/12/2020 16:48	24/12/2020 21:11	23/12/2020 16:48	24/12/2020 21:11	28,37	80	2269,93	CHI
202012134003	MIMOSO DE GOIAS	MU12313927	PADRE BERNARDO	23/12/2020 16:48	23/12/2020 19:19	23/12/2020 16:48	23/12/2020 19:19	2,51	18	45,13	CHI
202012135438	LUZIANIA	LZ21344836	MARAJOARA	23/12/2020 16:48	23/12/2020 21:10	23/12/2020 16:48	23/12/2020 21:10	4,35	5	21,76	CHI

202012134007	ACREUNA	EU12214052	ACREUNA	23/12/2020 16:49	24/12/2020 05:11	23/12/2020 16:49	24/12/2020 05:11	12,37	3	37,12	CHI
202012134013	GOIATUBA	JV12266597	GOIATUBA S1	23/12/2020 16:50	24/12/2020 11:05	23/12/2020 16:50	24/12/2020 11:05	18,25	1	18,25	CHI
202012134433	PADRE BERNARDO	PB16408270	PADRE BERNARDO	23/12/2020 16:56	25/12/2020 00:09	23/12/2020 20:05	23/12/2020 22:33	2,46	11	27,06	CHI
202012134433	PADRE BERNARDO	6361135	PADRE BERNARDO	23/12/2020 16:56	25/12/2020 00:09	23/12/2020 16:56	24/12/2020 03:20	10,39	33	342,90	CHI
202012134433	VILA PROPICIO	PB12376785RE	PADRE BERNARDO	23/12/2020 16:56	25/12/2020 00:09	23/12/2020 22:30	24/12/2020 04:20	5,84	9	52,53	CHI
202012134433	PADRE BERNARDO	PB12376785RE	PADRE BERNARDO	23/12/2020 16:56	25/12/2020 00:09	23/12/2020 22:30	24/12/2020 04:20	5,84	37	215,96	CHI
202012134433	MIMOSO DE GOIAS	PB12376785RE	PADRE BERNARDO	23/12/2020 16:56	25/12/2020 00:09	23/12/2020 22:30	24/12/2020 04:20	5,84	48	280,16	CHI
202012134433	PADRE BERNARDO	PB16408267	PADRE BERNARDO	23/12/2020 16:56	25/12/2020 00:09	23/12/2020 22:30	24/12/2020 07:14	8,75	53	463,54	CHI
202012134433	PADRE BERNARDO	PB12376778LD	PADRE BERNARDO	23/12/2020 16:56	25/12/2020 00:09	23/12/2020 22:30	24/12/2020 08:23	9,89	38	375,94	CHI
202012134433	PADRE BERNARDO	PB12382210	PADRE BERNARDO	23/12/2020 16:56	25/12/2020 00:09	24/12/2020 15:36	24/12/2020 16:56	1,33	38	50,42	CHI
202012134433	PADRE BERNARDO	PB10396067	PADRE BERNARDO	23/12/2020 16:56	25/12/2020 00:09	23/12/2020 22:30	24/12/2020 21:17	22,79	10	227,92	CHI
202012134433	PADRE BERNARDO	PB12052000	PADRE BERNARDO	23/12/2020 16:56	25/12/2020 00:09	23/12/2020 22:30	24/12/2020 22:04	23,58	4	94,32	CHI
202012134433	MIMOSO DE GOIAS	PB12376742	PADRE BERNARDO	23/12/2020 16:56	25/12/2020 00:09	23/12/2020 22:30	24/12/2020 22:06	23,60	2	47,20	CHI
202012134433	MIMOSO DE GOIAS	PB13408265B	PADRE BERNARDO	23/12/2020 16:56	25/12/2020 00:09	25/12/2020 00:01	25/12/2020 00:09	0,12	48	5,91	CHI
202012134433	VILA PROPICIO	PB13408265B	PADRE BERNARDO	23/12/2020 16:56	25/12/2020 00:09	25/12/2020 00:01	25/12/2020 00:09	0,12	9	1,11	CHI
202012134433	PADRE BERNARDO	PB13408265B	PADRE BERNARDO	23/12/2020 16:56	25/12/2020 00:09	25/12/2020 00:01	25/12/2020 00:09	0,12	172	21,17	CHI
202012134038	FORMOSA	610104860	ITUIQUIRA	23/12/2020 16:57	23/12/2020 21:42	23/12/2020 16:57	23/12/2020 21:42	4,75	1	4,75	CHI
202012134044	CATALAO	CT12358318	CATALAO S2	23/12/2020 16:59	23/12/2020 21:13	23/12/2020 16:59	23/12/2020 21:13	4,23	7	29,58	CHI
202012134986	CALDAZINHA	SW12217284	CEPAIGO S2	23/12/2020 17:05	23/12/2020 21:09	23/12/2020 17:05	23/12/2020 21:09	4,07	6	24,40	CHI
202012134986	LEOPOLDO DE BULHOES	SW12217284	CEPAIGO S2	23/12/2020 17:05	23/12/2020 21:09	23/12/2020 17:05	23/12/2020 21:09	4,07	53	215,55	CHI
202012134073	FAINA	FC12057965	GOIAS	23/12/2020 17:06	23/12/2020 19:00	23/12/2020 17:06	23/12/2020 19:00	1,89	6	11,32	CHI
202012134078	BURITINOPOLIS	SA12384201	IACIARA S2	23/12/2020 17:09	23/12/2020 20:34	23/12/2020 17:09	23/12/2020 20:34	3,42	1	3,42	CHI
202012134078	POSSE	SA12384201	IACIARA S2	23/12/2020 17:09	23/12/2020 20:34	23/12/2020 17:09	23/12/2020 20:34	3,42	20	68,32	CHI
202012134078	SIMOLANDIA	SA12384201	IACIARA S2	23/12/2020 17:09	23/12/2020 20:34	23/12/2020 17:09	23/12/2020 20:34	3,42	2	6,83	CHI
202012134080	SANTA FE DE GOIAS	RN12378891	BRITANIA	23/12/2020 17:09	23/12/2020 22:57	23/12/2020 17:09	23/12/2020 22:57	5,79	4	23,16	CHI
202012134081	CORUMBA DE GOIAS	CB12381243	CORUMBA	23/12/2020 17:09	24/12/2020 21:32	23/12/2020 17:09	24/12/2020 21:32	28,38	7	198,64	CHI
202012134151	FAZENDA NOVA	NB12099390	JUSSARA	23/12/2020 17:14	24/12/2020 08:55	23/12/2020 17:14	24/12/2020 08:55	15,68	16	250,90	CHI
202012134151	NOVO BRASIL	NB12099390	JUSSARA	23/12/2020 17:14	24/12/2020 08:55	23/12/2020 17:14	24/12/2020 08:55	15,68	28	439,07	CHI
202012134140	JUSSARA	NB12117282	JUSSARA	23/12/2020 17:16	24/12/2020 03:24	23/12/2020 17:16	24/12/2020 03:24	10,13	1	10,13	CHI
202012134140	NOVO BRASIL	NB12117282	JUSSARA	23/12/2020 17:16	24/12/2020 03:24	23/12/2020 17:16	24/12/2020 03:24	10,13	12	121,57	CHI
202012134140	FAZENDA NOVA	NB12117282	JUSSARA	23/12/2020 17:16	24/12/2020 03:24	23/12/2020 17:16	24/12/2020 03:24	10,13	1	10,13	CHI
202012134117	SANTA CRUZ DE GOIAS	BC12012519	PIRES DO RIO S2	23/12/2020 17:17	24/12/2020 08:48	23/12/2020 17:17	24/12/2020 08:48	15,51	2	31,02	CHI
202012134119	ITUMBIARA	IT12305618	PARANAIBA	23/12/2020 17:17	23/12/2020 20:34	23/12/2020 17:17	23/12/2020 20:34	3,27	2	6,54	CHI
202012134138	JATAI	JT12182021	JATAI S1	23/12/2020 17:22	24/12/2020 10:49	23/12/2020 17:22	24/12/2020 10:49	17,44	1	17,44	CHI
202012134145	PROFESSOR JAMIL SAFADY	PJ12308015	ROCHEDO	23/12/2020 17:23	24/12/2020 09:10	23/12/2020 17:23	24/12/2020 09:10	15,78	2	31,55	CHI
202012134153	RIO VERDE	RV12023964	CABRIUVA S2	23/12/2020 17:24	23/12/2020 19:22	23/12/2020 17:24	23/12/2020 19:22	1,96	3	5,87	CHI
202012134157	ITAPURANGA	IK12250601	ITAPURANGA	23/12/2020 17:26	24/12/2020 00:10	23/12/2020 17:26	24/12/2020 00:10	6,74	264	1780,61	CHI
202012134159	SAO JOAO D ALIANCA	10022913090	SAO JOAO D ALIANCA	23/12/2020 17:26	24/12/2020 10:31	23/12/2020 17:26	24/12/2020 10:31	17,09	1	17,09	CHI
202012134161	MOSSAMEDES	MD12060620	ITABERAI S2	23/12/2020 17:26	23/12/2020 19:56	23/12/2020 17:26	23/12/2020 19:56	2,49	10	24,85	CHI
202012134881	ALEXANIA	AX12398552	ALEXANIA	23/12/2020 17:28	24/12/2020 08:15	23/12/2020 17:28	24/12/2020 08:15	14,78	3	44,34	CHI
202012134172	CATALAO	8040528	CATALAO S1	23/12/2020 17:29	23/12/2020 21:10	23/12/2020 17:29	23/12/2020 21:10	3,67	1	3,67	CHI
202012134177	APARECIDA DE GOIANIA	AP12034894	CEPAIGO S1	23/12/2020 17:31	23/12/2020 21:04	23/12/2020 17:31	23/12/2020 21:04	3,55	23	81,64	CHI
202012134779	BOM JARDIM DE GOIAS	BM12065617	BOM JARDIM	23/12/2020 17:32	24/12/2020 08:25	23/12/2020 17:32	24/12/2020 08:25	14,87	2	29,74	CHI
202012134187	CIDADE OCIDENTAL	DH12376173	MARAJOAIRA	23/12/2020 17:34	24/12/2020 12:10	23/12/2020 17:34	24/12/2020 12:10	18,59	3	55,76	CHI
202012134254	CRIXAS	CX12102899RE	SERRA DO OURO	23/12/2020 17:34	23/12/2020 22:09	23/12/2020 17:34	23/12/2020 22:09	4,57	65	296,91	CHI
202012134191	SANTA TEREZINHA DE GOIAS	SG12316998	SANTA TEREZINHA	23/12/2020 17:35	23/12/2020 20:38	23/12/2020 17:35	23/12/2020 20:38	3,05	6	18,29	CHI
202012134238	PIRACANJUBA	PJ12300660	CRISTIANOPOLIS	23/12/2020 17:35	23/12/2020 20:27	23/12/2020 17:35	23/12/2020 20:27	2,85	68	193,91	CHI
202012134246	SANTA RITA DO NOVO DESTINO	GE12006474	BARRO ALTO	23/12/2020 17:36	23/12/2020 22:13	23/12/2020 17:36	23/12/2020 22:13	4,60	6	27,63	CHI
202012134246	SAO LUIZ DO NORTE	GE12006474	BARRO ALTO	23/12/2020 17:36	23/12/2020 22:13	23/12/2020 17:36	23/12/2020 22:13	4,60	1	4,60	CHI
202012134246	GOIANESIA	GE12006474	BARRO ALTO	23/12/2020 17:36	23/12/2020 22:13	23/12/2020 17:36	23/12/2020 22:13	4,60	2	9,21	CHI
202012134557	SANTO ANTONIO DA BARRA	BZ12123238	ACREUNA	23/12/2020 17:37	23/12/2020 20:00	23/12/2020 17:37	23/12/2020 20:00	2,40	7	16,79	CHI

202012134207	BONOPOLIS	BX12292423	SAO MIGUEL DO ARAGUAIA	23/12/2020 17:38	23/12/2020 23:07	23/12/2020 17:38	23/12/2020 23:07	5,48	2	10,96	CHI
202012134209	HIDROLANDIA	HD11281247	ANHANGUERA	23/12/2020 17:38	24/12/2020 00:50	23/12/2020 17:38	24/12/2020 00:50	7,19	5	35,96	CHI
202012135326	CAIAPONIA	CP12380880	CAIAPONIA	23/12/2020 17:40	24/12/2020 07:39	23/12/2020 17:40	24/12/2020 07:39	13,98	13	181,71	CHI
202012134302	MORRINHOS	MR12000403	MORRINHOS	23/12/2020 17:41	24/12/2020 07:00	23/12/2020 17:41	24/12/2020 07:00	13,31	14	186,31	CHI
202012134236	LEOPOLDO DE BULHOES	10002077033	DAIA S1	23/12/2020 17:44	23/12/2020 23:28	23/12/2020 17:44	23/12/2020 23:28	5,74	1	5,74	CHI
202012134330	SERRANOPOLIS	SX12205265	JATAI S1	23/12/2020 17:47	24/12/2020 14:20	23/12/2020 17:47	24/12/2020 14:20	20,54	10	205,39	CHI
202012134457	SAO JOAO D ALIANCA	TL12302766	SAO JOAO D ALIANCA	23/12/2020 17:47	24/12/2020 07:30	23/12/2020 17:47	24/12/2020 07:30	13,71	1	13,71	CHI
202012134457	AGUA FRIA DE GOIAS	TL12302766	SAO JOAO D ALIANCA	23/12/2020 17:47	24/12/2020 07:30	23/12/2020 17:47	24/12/2020 07:30	13,71	79	1082,83	CHI
202012134261	MINEIROS	1390034620	PARQUE DAS EMAS	23/12/2020 17:50	24/12/2020 01:00	23/12/2020 17:50	24/12/2020 01:00	7,16	1	7,16	CHI
202012135336	NOVA CRIXAS	NA12096364	NOVA CRIXAS	23/12/2020 17:52	24/12/2020 02:16	23/12/2020 17:52	24/12/2020 02:16	8,39	5	41,97	CHI
202012134273	CORUMBA DE GOIAS	00200214	ANAPOLIS UNIVERSITARIO S1	23/12/2020 17:53	23/12/2020 20:00	23/12/2020 17:53	23/12/2020 20:00	2,12	64	135,45	CHI
202012134273	ABADIANIA	00200214	ANAPOLIS UNIVERSITARIO S1	23/12/2020 17:53	23/12/2020 20:00	23/12/2020 17:53	23/12/2020 20:00	2,12	1377	2914,27	CHI
202012134400	JAUPACI	JP12045494	IPORA	23/12/2020 17:54	24/12/2020 11:29	23/12/2020 17:54	24/12/2020 11:29	17,57	10	175,73	CHI
202012134662	GOIANIA	GN12198269	CAMPINAS S2	23/12/2020 17:54	23/12/2020 19:41	23/12/2020 17:54	23/12/2020 19:41	1,77	221	391,91	CHI
202012134345	INACIOLANDIA	ID32128272	QUIRINOPOLIS	23/12/2020 17:55	23/12/2020 19:57	23/12/2020 17:55	23/12/2020 19:57	2,03	8	16,21	CHI
202012134312	ANAPOLIS	20158531	JUNDIAI S1	23/12/2020 17:57	24/12/2020 02:21	23/12/2020 17:57	24/12/2020 02:21	8,40	1	8,40	CHI
202012134876	RIO VERDE	BZ12211442	SANTA HELENA S1	23/12/2020 17:58	23/12/2020 21:18	23/12/2020 17:58	23/12/2020 21:18	3,34	4	13,34	CHI
202012134876	SANTO ANTONIO DA BARRA	BZ12211442	SANTA HELENA S1	23/12/2020 17:58	23/12/2020 21:18	23/12/2020 17:58	23/12/2020 21:18	3,34	20	66,72	CHI
202012134559	RIO QUENTE	RQ12050905	VILA CORUMBA	23/12/2020 18:00	23/12/2020 21:24	23/12/2020 18:00	23/12/2020 21:24	3,39	12	40,65	CHI
202012134542	CORUMBAIBA	03080214	CATALAO S1	23/12/2020 18:02	24/12/2020 11:15	23/12/2020 18:02	23/12/2020 20:30	2,47	135	334,09	CHI
202012134542	MORRINHOS	03080214	CATALAO S1	23/12/2020 18:02	24/12/2020 11:15	23/12/2020 18:02	23/12/2020 20:30	2,47	1	2,47	CHI
202012134542	IPAMERI	03080214	CATALAO S1	23/12/2020 18:02	24/12/2020 11:15	23/12/2020 18:02	23/12/2020 20:30	2,47	15	37,12	CHI
202012134542	NOVA AURORA	03080214	CATALAO S1	23/12/2020 18:02	24/12/2020 11:15	23/12/2020 18:02	23/12/2020 20:30	2,47	1117	2764,26	CHI
202012134542	MORRINHOS	NE13203056	CATALAO S1	23/12/2020 18:02	24/12/2020 11:15	24/12/2020 00:49	24/12/2020 01:06	0,27	1	0,27	CHI
202012134542	NOVA AURORA	NE13203056	CATALAO S1	23/12/2020 18:02	24/12/2020 11:15	24/12/2020 00:49	24/12/2020 01:06	0,27	1117	302,52	CHI
202012134542	CORUMBAIBA	NE13203056	CATALAO S1	23/12/2020 18:02	24/12/2020 11:15	24/12/2020 00:49	24/12/2020 01:06	0,27	137	37,10	CHI
202012134542	IPAMERI	NE13203056	CATALAO S1	23/12/2020 18:02	24/12/2020 11:15	24/12/2020 00:49	24/12/2020 01:06	0,27	15	4,06	CHI
202012134542	NOVA AURORA	GD13147715	CATALAO S1	23/12/2020 18:02	24/12/2020 11:15	24/12/2020 02:17	24/12/2020 02:49	0,53	3	1,59	CHI
202012134542	MORRINHOS	00540434	CATALAO S1	23/12/2020 18:02	24/12/2020 11:15	24/12/2020 02:17	24/12/2020 02:49	0,53	1	0,53	CHI
202012134542	CORUMBAIBA	00540434	CATALAO S1	23/12/2020 18:02	24/12/2020 11:15	24/12/2020 02:17	24/12/2020 02:49	0,53	137	72,72	CHI
202012134542	NOVA AURORA	00540434	CATALAO S1	23/12/2020 18:02	24/12/2020 11:15	24/12/2020 02:17	24/12/2020 02:49	0,53	1117	592,94	CHI
202012134542	IPAMERI	00540434	CATALAO S1	23/12/2020 18:02	24/12/2020 11:15	24/12/2020 02:17	24/12/2020 02:49	0,53	15	7,96	CHI
202012134542	GOIANDIRA	00540434	CATALAO S1	23/12/2020 18:02	24/12/2020 11:15	24/12/2020 02:17	24/12/2020 02:49	0,53	7	3,72	CHI
202012134542	NOVA AURORA	00540434	CATALAO S1	23/12/2020 18:02	24/12/2020 11:15	24/12/2020 02:17	24/12/2020 02:49	0,53	14	7,43	CHI
202012134542	NOVA AURORA	GD13147717	CATALAO S1	23/12/2020 18:02	24/12/2020 11:15	24/12/2020 02:50	24/12/2020 08:40	5,82	3	17,46	CHI
202012134542	GOIANDIRA	NE13203055	CATALAO S1	23/12/2020 18:02	24/12/2020 11:15	24/12/2020 02:50	24/12/2020 09:31	6,68	7	46,74	CHI
202012134542	NOVA AURORA	NE13203055	CATALAO S1	23/12/2020 18:02	24/12/2020 11:15	24/12/2020 02:50	24/12/2020 09:31	6,68	14	93,48	CHI
202012134542	NOVA AURORA	NE13203056	CATALAO S1	23/12/2020 18:02	24/12/2020 11:15	24/12/2020 02:50	24/12/2020 10:28	7,62	935	7128,34	CHI
202012134542	MORRINHOS	NE13377055	CATALAO S1	23/12/2020 18:02	24/12/2020 11:15	24/12/2020 02:50	24/12/2020 10:51	8,01	1	8,01	CHI
202012134542	CORUMBAIBA	NE13377055	CATALAO S1	23/12/2020 18:02	24/12/2020 11:15	24/12/2020 02:50	24/12/2020 10:51	8,01	122	976,92	CHI
202012134542	NOVA AURORA	NE13377055	CATALAO S1	23/12/2020 18:02	24/12/2020 11:15	24/12/2020 02:50	24/12/2020 10:51	8,01	112	896,84	CHI
202012134542	IPAMERI	NE13377055	CATALAO S1	23/12/2020 18:02	24/12/2020 11:15	24/12/2020 02:50	24/12/2020 10:51	8,01	15	120,11	CHI
202012134542	NOVA AURORA	NE13000052	CATALAO S1	23/12/2020 18:02	24/12/2020 11:15	24/12/2020 02:50	24/12/2020 11:15	8,41	70	588,88	CHI
202012134542	CORUMBAIBA	NE13000052	CATALAO S1	23/12/2020 18:02	24/12/2020 11:15	24/12/2020 02:50	24/12/2020 11:15	8,41	15	126,19	CHI
202012134472	ITAUCU	IX12321505	INHUMAS S1	23/12/2020 18:05	23/12/2020 22:05	23/12/2020 18:05	23/12/2020 22:05	3,99	20	79,74	CHI
202012134472	ITABERAÍ	IX12321505	INHUMAS S1	23/12/2020 18:05	23/12/2020 22:05	23/12/2020 18:05	23/12/2020 22:05	3,99	1	3,99	CHI
202012134363	APARECIDA DE GOIANIA	AP12161136LD	ATLANTICO S2	23/12/2020 18:06	24/12/2020 02:25	23/12/2020 18:06	24/12/2020 02:25	8,30	430	3570,91	CHI
202012134579	GOIANIA	GN11002718	ATLANTICO S1	23/12/2020 18:09	23/12/2020 19:41	23/12/2020 18:09	23/12/2020 19:41	1,52	82	124,98	CHI
202012134856	GAMELEIRA DE GOIAS	GL12389474	DAIA S2	23/12/2020 18:23	23/12/2020 23:49	23/12/2020 18:23	23/12/2020 23:49	5,43	32	173,69	CHI
202012134856	ANAPOLIS	GL12389474	DAIA S2	23/12/2020 18:23	23/12/2020 23:49	23/12/2020 18:23	23/12/2020 23:49	5,43	4	21,71	CHI
202012134481	CALDAS NOVAS	RQ12100189	RIO QUENTE	23/12/2020 18:24	24/12/2020 00:35	23/12/2020 18:24	24/12/2020 00:35	6,18	134	828,49	CHI

202012134481	RIO QUENTE	RQ12100189	RIO QUENTE	23/12/2020 18:24	24/12/2020 00:35	23/12/2020 18:24	24/12/2020 00:35	6,18	87	537,90	CHI
202012134481	PIRACANJUBA	RQ12100189	RIO QUENTE	23/12/2020 18:24	24/12/2020 00:35	23/12/2020 18:24	24/12/2020 00:35	6,18	1	6,18	CHI
202012134481	MORRINHOS	RQ12100189	RIO QUENTE	23/12/2020 18:24	24/12/2020 00:35	23/12/2020 18:24	24/12/2020 00:35	6,18	8	49,46	CHI
202012134752	TRINDADE	TR12001815	TRINDADE	23/12/2020 18:24	23/12/2020 21:36	23/12/2020 18:24	23/12/2020 21:36	3,19	2	6,38	CHI
202012134752	GOIANIA	TR12001815	TRINDADE	23/12/2020 18:24	23/12/2020 21:36	23/12/2020 18:24	23/12/2020 21:36	3,19	6	19,14	CHI
202012134825	IPORA	IR12070226LD	IPORA	23/12/2020 18:24	23/12/2020 22:59	23/12/2020 18:24	23/12/2020 22:59	4,59	524	2405,01	CHI
202012135068	PORANGATU	PO12020611	NOVO PLANALTO	23/12/2020 18:26	23/12/2020 23:53	23/12/2020 18:26	23/12/2020 23:53	5,44	8	43,56	CHI
202012134465	GUARINOS	SG12291237	SANTA TEREZINHA	23/12/2020 18:27	23/12/2020 21:52	23/12/2020 18:27	23/12/2020 21:52	3,42	6	20,50	CHI
202012134465	CRIXAS	SG12291237	SANTA TEREZINHA	23/12/2020 18:27	23/12/2020 21:52	23/12/2020 18:27	23/12/2020 21:52	3,42	15	51,24	CHI
202012134476	PORANGATU	PO12187955	PORANGATU	23/12/2020 18:28	24/12/2020 17:52	23/12/2020 18:28	24/12/2020 17:52	23,39	2	46,78	CHI
202012134667	RIO VERDE	RV12024714	RIO VERDE S1	23/12/2020 18:28	23/12/2020 21:25	23/12/2020 18:28	23/12/2020 21:25	2,94	25	73,57	CHI
202012134483	LUZIANIA	LZ12183537	VIANOPOLIS	23/12/2020 18:30	24/12/2020 12:00	23/12/2020 18:30	24/12/2020 12:00	17,51	1	17,51	CHI
202012134484	CRISTALINA	KR12389576	CRISTALINA S2	23/12/2020 18:30	23/12/2020 20:51	23/12/2020 18:30	23/12/2020 20:51	2,35	40	93,87	CHI
202012134745	GOIANDIRA	GD12000006	CATALAO S1	23/12/2020 18:30	23/12/2020 21:10	23/12/2020 18:30	23/12/2020 21:10	2,65	320	848,27	CHI
202012134536	PIRENOPOLIS	PV12123145	SAO FRANCISCO DE GOIAS	23/12/2020 18:31	24/12/2020 10:41	23/12/2020 18:31	24/12/2020 10:41	16,16	12	193,86	CHI
202012134767	RIO QUENTE	RQ12249797RE	RIO QUENTE	23/12/2020 18:31	23/12/2020 23:30	23/12/2020 18:31	23/12/2020 23:30	4,98	6	29,89	CHI
202012134767	MORRINHOS	RQ12249797RE	RIO QUENTE	23/12/2020 18:31	23/12/2020 23:30	23/12/2020 18:31	23/12/2020 23:30	4,98	10	49,82	CHI
202012131054	SERRANOPOLIS	SX12296496	JATAI S1	23/12/2020 18:32	24/12/2020 12:14	23/12/2020 18:32	24/12/2020 12:14	17,70	145	2566,10	CHI
202012134504	NOVA ROMA	ND12229416	IACIARA S2	23/12/2020 18:32	23/12/2020 20:42	23/12/2020 18:32	23/12/2020 20:42	2,16	8	17,24	CHI
202012134822	CACU	CC12142036	CACHOEIRA ALTA	23/12/2020 18:35	23/12/2020 22:15	23/12/2020 18:35	23/12/2020 22:15	3,66	7	25,62	CHI
202012134532	CAIAPONIA	CP12235069	CAIAPONIA	23/12/2020 18:37	24/12/2020 09:19	23/12/2020 18:37	24/12/2020 09:19	14,68	6	88,10	CHI
202012134541	ARAGARCAS	AG12334918	ARAGARCAS	23/12/2020 18:38	24/12/2020 07:45	23/12/2020 18:38	24/12/2020 07:45	13,11	3	39,32	CHI
202012134549	RIO VERDE	10024156750	RIO VERDE S1	23/12/2020 18:39	23/12/2020 22:37	23/12/2020 18:39	23/12/2020 22:37	3,97	1	3,97	CHI
202012134560	IPORA	DI12062867LD	IPORA	23/12/2020 18:40	24/12/2020 02:40	23/12/2020 18:40	24/12/2020 02:40	8,00	3	24,00	CHI
202012134560	DIORAMA	DI12062867LD	IPORA	23/12/2020 18:40	24/12/2020 02:40	23/12/2020 18:40	24/12/2020 02:40	8,00	14	112,01	CHI
202012135632	MUTUNOPOLIS	PO12391912	PORANGATU	23/12/2020 18:40	24/12/2020 18:00	23/12/2020 18:40	24/12/2020 17:36	22,92	34	779,33	CHI
202012135632	PORANGATU	PO12391912	PORANGATU	23/12/2020 18:40	24/12/2020 18:00	23/12/2020 18:40	24/12/2020 17:36	22,92	65	1489,89	CHI
202012135632	PORANGATU	PO12391912	PORANGATU	23/12/2020 18:40	24/12/2020 18:00	23/12/2020 18:40	24/12/2020 17:52	23,19	30	695,68	CHI
202012135632	MUTUNOPOLIS	PO12391912	PORANGATU	23/12/2020 18:40	24/12/2020 18:00	23/12/2020 18:40	24/12/2020 17:52	23,19	4	92,76	CHI
202012135632	PORANGATU	PO12391912	PORANGATU	23/12/2020 18:40	24/12/2020 18:00	23/12/2020 18:40	24/12/2020 18:00	23,32	2	46,64	CHI
202012134585	CATALAO	CT11192516	CATALAO S2	23/12/2020 18:42	23/12/2020 20:06	23/12/2020 18:42	23/12/2020 20:06	1,40	118	164,84	CHI
202012135140	VIANOPOLIS	VN12117212	PIRES DO RIO S2	23/12/2020 18:42	23/12/2020 23:05	23/12/2020 18:42	23/12/2020 23:05	4,38	37	161,91	CHI
202012135140	SAO MIGUEL DO PASSA QUATRO	VN12117212	PIRES DO RIO S2	23/12/2020 18:42	23/12/2020 23:05	23/12/2020 18:42	23/12/2020 23:05	4,38	2	8,75	CHI
202012134616	PORANGATU	TA12181585	NOVO PLANALTO	23/12/2020 18:46	23/12/2020 21:42	23/12/2020 18:46	23/12/2020 21:42	2,93	1	2,93	CHI
202012134618	PETROLINA DE GOIAS	PG21298019	PETROLINA	23/12/2020 18:46	24/12/2020 12:51	23/12/2020 18:46	24/12/2020 12:51	18,08	2	36,17	CHI
202012134625	IPORA	IR21204827	ARENOPOLIS	23/12/2020 18:47	24/12/2020 07:44	23/12/2020 18:47	24/12/2020 07:44	12,95	1	12,95	CHI
202012135102	PORANGATU	PO12064911	NOVO PLANALTO	23/12/2020 18:47	23/12/2020 22:02	23/12/2020 18:47	23/12/2020 22:02	3,25	134	435,13	CHI
202012134646	JARAGUA	70062924	JARAGUA	23/12/2020 18:49	24/12/2020 14:53	23/12/2020 18:49	24/12/2020 14:53	20,06	1	20,06	CHI
202012134700	ANAPOLIS	AN11200914	ANAPOLIS UNIVERSITARIO S2	23/12/2020 18:50	24/12/2020 07:33	23/12/2020 18:50	23/12/2020 21:56	3,11	131	406,76	CHI
202012134700	PIRENOPOLIS	AN16407074	ANAPOLIS UNIVERSITARIO S2	23/12/2020 18:50	24/12/2020 07:33	23/12/2020 21:39	23/12/2020 21:58	0,33	56	18,36	CHI
202012134700	ANAPOLIS	AN16407074	ANAPOLIS UNIVERSITARIO S2	23/12/2020 18:50	24/12/2020 07:33	23/12/2020 21:39	23/12/2020 21:58	0,33	415	136,03	CHI
202012134700	ABADIANIA	AN16401571	ANAPOLIS UNIVERSITARIO S2	23/12/2020 18:50	24/12/2020 07:33	23/12/2020 21:39	23/12/2020 22:00	0,35	18	6,21	CHI
202012134700	CAMPO LIMPO	AN16401571	ANAPOLIS UNIVERSITARIO S2	23/12/2020 18:50	24/12/2020 07:33	23/12/2020 21:39	23/12/2020 22:00	0,35	18	6,21	CHI
202012134700	ANAPOLIS	AN16401571	ANAPOLIS UNIVERSITARIO S2	23/12/2020 18:50	24/12/2020 07:33	23/12/2020 21:39	23/12/2020 22:00	0,35	5537	1911,80	CHI
202012134700	PIRENOPOLIS	AN16401571	ANAPOLIS UNIVERSITARIO S2	23/12/2020 18:50	24/12/2020 07:33	23/12/2020 21:39	23/12/2020 22:00	0,35	30	10,36	CHI
202012134700	ANAPOLIS	AN11200914	ANAPOLIS UNIVERSITARIO S2	23/12/2020 18:50	24/12/2020 07:33	23/12/2020 23:34	24/12/2020 06:53	7,31	131	957,72	CHI
202012134700	ANAPOLIS	AN13000002	ANAPOLIS UNIVERSITARIO S2	23/12/2020 18:50	24/12/2020 07:33	23/12/2020 21:39	24/12/2020 07:33	9,90	3000	29711,67	CHI
202012134726	CAMPINORTE	CR12070384	CAMPINORTE	23/12/2020 18:50	23/12/2020 20:50	23/12/2020 18:50	23/12/2020 20:50	1,99	8	15,96	CHI
202012134726	NOVA IGUACU DE GOIAS	CR12070384	CAMPINORTE	23/12/2020 18:50	23/12/2020 20:50	23/12/2020 18:50	23/12/2020 20:50	1,99	23	45,88	CHI
202012134659	BALIZA	BH21359281	BOM JARDIM	23/12/2020 18:51	24/12/2020 11:15	23/12/2020 18:51	24/12/2020 11:15	16,39	2	32,78	CHI
202012134680	ITUMBIRA	IT12033699	CACHOEIRA DOURADA	23/12/2020 18:54	23/12/2020 23:29	23/12/2020 18:54	23/12/2020 23:29	4,57	11	50,25	CHI

202012134685	JUSSARA	JR21017178	BRITANIA	23/12/2020 18:55	24/12/2020 11:30	23/12/2020 18:55	24/12/2020 11:30	16,57	1	16,57	CHI
202012135040	DIORAMA	DI12390155	IPORA	23/12/2020 18:58	23/12/2020 23:15	23/12/2020 18:58	23/12/2020 23:15	4,29	1	4,29	CHI
202012135040	MONTES CLAROS DE GOIAS	DI12390155	IPORA	23/12/2020 18:58	23/12/2020 23:15	23/12/2020 18:58	23/12/2020 23:15	4,29	3	12,86	CHI
202012134746	SAO JOAO D ALIANCA	JL21151476	SAO JOAO D ALIANCA	23/12/2020 19:04	24/12/2020 12:24	23/12/2020 19:04	24/12/2020 12:24	17,34	1	17,34	CHI
202012134757	CRISTALINA	KR21270424	CRISTALINA S2	23/12/2020 19:06	23/12/2020 23:53	23/12/2020 19:06	23/12/2020 23:53	4,79	1	4,79	CHI
202012134768	INHUMAS	IN21000172	INHUMAS S1	23/12/2020 19:07	23/12/2020 21:03	23/12/2020 19:07	23/12/2020 21:03	1,93	1	1,93	CHI
202012134807	LAGOA SANTA	Z300019377	ITAJA S2	23/12/2020 19:15	23/12/2020 23:29	23/12/2020 19:15	23/12/2020 23:29	4,24	1	4,24	CHI
202012134811	GOIANIA	GN11140402	XAVANTES	23/12/2020 19:16	24/12/2020 00:01	23/12/2020 19:16	24/12/2020 00:01	4,74	62	293,88	CHI
202012134820	GOIANDIRA	GD12216033	CATALAO S1	23/12/2020 19:18	24/12/2020 02:39	23/12/2020 19:18	24/12/2020 02:39	7,34	52	381,85	CHI
202012134924	SERRANOPOLIS	SX12123303RE	ITAJA S1	23/12/2020 19:19	25/12/2020 09:27	23/12/2020 19:19	24/12/2020 13:29	18,16	17	308,80	CHI
202012134924	SERRANOPOLIS	SX12123303RE	ITAJA S1	23/12/2020 19:19	25/12/2020 09:27	23/12/2020 19:19	24/12/2020 23:19	28,00	9	252,04	CHI
202012134924	SERRANOPOLIS	SX12123303RE	ITAJA S1	23/12/2020 19:19	25/12/2020 09:27	23/12/2020 19:19	25/12/2020 01:51	30,53	4	122,13	CHI
202012134924	SERRANOPOLIS	SX12123303RE	ITAJA S1	23/12/2020 19:19	25/12/2020 09:27	23/12/2020 19:19	25/12/2020 09:27	38,13	5	190,65	CHI
202012134924	SERRANOPOLIS	SX12123303RE	ITAJA S1	23/12/2020 19:19	25/12/2020 09:27	25/12/2020 01:51	25/12/2020 09:27	7,59	26	197,40	CHI
202012134924	SERRANOPOLIS	SX12123303RE	ITAJA S1	23/12/2020 19:19	25/12/2020 09:27	25/12/2020 01:57	25/12/2020 09:27	7,50	4	29,99	CHI
202012135062	JATAI	JT12260426RE	JATAI S1	23/12/2020 19:24	24/12/2020 10:04	23/12/2020 19:24	24/12/2020 10:04	14,66	119	1744,84	CHI
202012134857	IACIARA	IA12242614	IACIARA S1	23/12/2020 19:26	23/12/2020 23:45	23/12/2020 19:26	23/12/2020 23:45	4,30	2	8,60	CHI
202012135201	JATAI	JT12216740RE	JATAI S1	23/12/2020 19:29	24/12/2020 11:46	23/12/2020 19:29	24/12/2020 11:46	16,27	50	813,42	CHI
202012134921	PLANALTINA	PI12359566	PLANALTINA	23/12/2020 19:30	24/12/2020 01:18	23/12/2020 19:30	24/12/2020 01:18	5,79	6	34,71	CHI
202012134902	PONTALINA	PK12189810	PONTALINA	23/12/2020 19:33	23/12/2020 22:26	23/12/2020 19:33	23/12/2020 22:26	2,87	3	8,61	CHI
202012134906	ITUMBIARA	IT12309999	ITUMBIARA VELHA S1	23/12/2020 19:34	24/12/2020 01:40	23/12/2020 19:34	24/12/2020 01:40	6,09	3	18,26	CHI
202012135061	CALDAS NOVAS	CN12265590	SERRA DE CALDAS	23/12/2020 19:34	23/12/2020 23:46	23/12/2020 19:34	23/12/2020 23:46	4,19	177	742,27	CHI
202012134928	URUACU	UR12278481	URUACU	23/12/2020 19:39	24/12/2020 08:22	23/12/2020 19:39	24/12/2020 08:22	12,71	6	76,26	CHI
202012134946	PORANGATU	10004347070	PORANGATU	23/12/2020 19:43	24/12/2020 09:36	23/12/2020 19:43	24/12/2020 09:36	13,88	1	13,88	CHI
202012134952	SANTA RITA DO ARAGUAIA	SU12301950RE	SANTA RITA DO ARAGUAIA	23/12/2020 19:44	23/12/2020 22:37	23/12/2020 19:44	23/12/2020 22:37	2,88	22	63,27	CHI
202012134952	BURITINOPOLIS	SU12301950RE	SANTA RITA DO ARAGUAIA	23/12/2020 19:44	23/12/2020 22:37	23/12/2020 19:44	23/12/2020 22:37	2,88	1	2,88	CHI
202012135009	JATAI	JT12238549	JATAI S1	23/12/2020 19:46	24/12/2020 07:52	23/12/2020 19:46	24/12/2020 07:52	12,10	6	72,60	CHI
202012135248	SANTA TEREZINHA DE GOIAS	GG12166526	SANTA TEREZINHA	23/12/2020 19:46	23/12/2020 23:31	23/12/2020 19:46	23/12/2020 23:31	3,74	12	44,94	CHI
202012135007	CACHOEIRA DOURADA	CD12000176	CACHOEIRA DOURADA	23/12/2020 19:48	23/12/2020 23:30	23/12/2020 19:48	23/12/2020 23:30	3,68	6	22,11	CHI
202012135082	GOIAS	GS12076721	GOIAS	23/12/2020 19:54	24/12/2020 04:14	23/12/2020 19:54	24/12/2020 04:14	8,33	23	191,49	CHI
202012135042	CAVALCANTE	CJ12408520	MINACU	23/12/2020 19:57	24/12/2020 14:12	23/12/2020 19:57	24/12/2020 14:12	18,24	5	91,22	CHI
202012135090	INDIARA	PL12349352	PALMEIRAS	23/12/2020 19:58	23/12/2020 22:06	23/12/2020 19:58	23/12/2020 22:06	2,13	3	6,38	CHI
202012135090	PALMEIRAS DE GOIAS	PL12349352	PALMEIRAS	23/12/2020 19:58	23/12/2020 22:06	23/12/2020 19:58	23/12/2020 22:06	2,13	67	142,58	CHI
202012135343	IACIARA	IA12195949	IACIARA S1	23/12/2020 20:03	23/12/2020 23:43	23/12/2020 20:03	23/12/2020 23:43	3,66	19	69,56	CHI
202012135079	LUZIANIA	LZ12189760	VIANOPOLIS	23/12/2020 20:05	24/12/2020 02:23	23/12/2020 20:05	24/12/2020 02:23	6,30	21	132,27	CHI
202012135239	VILA PROPICIO	ZN12402010RE	COCALZINHO	23/12/2020 20:09	25/12/2020 00:14	23/12/2020 20:09	24/12/2020 12:27	16,29	1	16,29	CHI
202012135239	COCALZINHO DE GOIAS	ZN12402010RE	COCALZINHO	23/12/2020 20:09	25/12/2020 00:14	23/12/2020 20:09	24/12/2020 12:27	16,29	149	2427,95	CHI
202012135239	COCALZINHO DE GOIAS	ZN12402010RE	COCALZINHO	23/12/2020 20:09	25/12/2020 00:14	24/12/2020 12:30	24/12/2020 14:34	2,07	6	12,40	CHI
202012135239	COCALZINHO DE GOIAS	ZN12297780	COCALZINHO	23/12/2020 20:09	25/12/2020 00:14	23/12/2020 20:09	24/12/2020 18:20	22,18	9	199,62	CHI
202012135239	COCALZINHO DE GOIAS	ZN13381223	COCALZINHO	23/12/2020 20:09	25/12/2020 00:14	24/12/2020 12:30	24/12/2020 19:28	6,97	17	118,41	CHI
202012135239	COCALZINHO DE GOIAS	ZN13273033	COCALZINHO	23/12/2020 20:09	25/12/2020 00:14	24/12/2020 12:30	24/12/2020 22:30	9,99	19	189,76	CHI
202012135239	COCALZINHO DE GOIAS	ZN12273304RE	COCALZINHO	23/12/2020 20:09	25/12/2020 00:14	24/12/2020 12:30	25/12/2020 00:14	11,72	52	609,66	CHI
202012135239	VILA PROPICIO	ZN12273304RE	COCALZINHO	23/12/2020 20:09	25/12/2020 00:14	24/12/2020 12:30	25/12/2020 00:14	11,72	1	11,72	CHI
202012135239	COCALZINHO DE GOIAS	ZN12258524RE	COCALZINHO	23/12/2020 20:09	25/12/2020 00:14	24/12/2020 12:30	25/12/2020 00:14	11,73	55	645,17	CHI
202012135132	MINEIROS	MY12324492	PARQUE DAS EMAS	23/12/2020 20:14	24/12/2020 23:37	23/12/2020 20:14	24/12/2020 23:37	27,38	1	27,38	CHI
202012135135	AMORINOPOLIS	1240003230	IPORA	23/12/2020 20:14	24/12/2020 07:54	23/12/2020 20:14	24/12/2020 07:54	11,66	1	11,66	CHI
202012135136	GOIANESIA	GE12297424LD	GOIANESIA S1	23/12/2020 20:15	24/12/2020 17:33	23/12/2020 20:15	24/12/2020 17:33	21,29	1	21,29	CHI
202012135529	SANTA FE DE GOIAS	RN12378892	BRITANIA	23/12/2020 20:16	23/12/2020 23:37	23/12/2020 20:16	23/12/2020 23:37	3,34	19	63,49	CHI
202012135145	MINEIROS	MY12332634RE	PARQUE DAS EMAS	23/12/2020 20:20	24/12/2020 22:10	23/12/2020 20:20	24/12/2020 22:10	25,84	9	232,55	CHI
202012135206	ITAJA	03700234	CACHOEIRA ALTA	23/12/2020 20:20	24/12/2020 15:01	23/12/2020 20:20	24/12/2020 15:01	18,69	7	130,81	CHI
202012135206	ITARUMA	03700234	CACHOEIRA ALTA	23/12/2020 20:20	24/12/2020 15:01	23/12/2020 20:20	24/12/2020 15:01	18,69	79	1476,25	CHI

202012135206	CACU	03700234	CACHOEIRA ALTA	23/12/2020 20:20	24/12/2020 15:01	23/12/2020 20:20	24/12/2020 15:01	18,69	51	953,02	CHI
202012135160	PLANALTINA	PI12262312	PLANALTINA	23/12/2020 20:26	23/12/2020 23:02	23/12/2020 20:26	23/12/2020 23:02	2,59	10	25,91	CHI
202012135175	FORMOSA	610025363	ITUIQUIRA	23/12/2020 20:31	23/12/2020 22:48	23/12/2020 20:31	23/12/2020 22:48	2,28	1	2,28	CHI
202012135194	ANAPOLIS	AN12321084	ANAPOLIS UNIVERSITARIO S1	23/12/2020 20:31	24/12/2020 08:18	23/12/2020 20:31	24/12/2020 08:18	11,78	7	82,46	CHI
202012135200	LEOPOLDO DE BULHOES	LB12000624	DAIA S1	23/12/2020 20:32	24/12/2020 13:36	23/12/2020 20:32	24/12/2020 01:45	5,22	28	146,25	CHI
202012135200	LEOPOLDO DE BULHOES	LB12000624	DAIA S1	23/12/2020 20:32	24/12/2020 13:36	23/12/2020 20:32	24/12/2020 13:36	17,07	5	85,35	CHI
202012135200	LEOPOLDO DE BULHOES	LB12000624	DAIA S1	23/12/2020 20:32	24/12/2020 13:36	24/12/2020 12:33	24/12/2020 13:36	1,05	28	29,27	CHI
202012135257	JARAGUA	SR12099307	INHUMAS S1	23/12/2020 20:34	24/12/2020 14:15	23/12/2020 20:34	24/12/2020 14:15	17,67	12	212,10	CHI
202012135277	SAO LUIS DE MONTES BELOS	SL12003965	SAO LUIZ DOS MONTES BELOS	23/12/2020 20:38	24/12/2020 01:12	23/12/2020 20:38	24/12/2020 01:12	4,55	11	50,07	CHI
202012135284	PIRENOPOLIS	AN12084838	NEROPOLIS S1	23/12/2020 20:45	24/12/2020 09:11	23/12/2020 20:45	24/12/2020 09:11	12,43	1	12,43	CHI
202012135284	ANAPOLIS	AN12084838	NEROPOLIS S1	23/12/2020 20:45	24/12/2020 09:11	23/12/2020 20:45	24/12/2020 09:11	12,43	13	161,60	CHI
202012135232	CRIXAS	CX12214528	SERRA DO OURO	23/12/2020 20:47	24/12/2020 03:01	23/12/2020 20:47	24/12/2020 03:01	6,22	1	6,22	CHI
202012135234	BALIZA	BH12331363	BOM JARDIM	23/12/2020 20:48	24/12/2020 11:20	23/12/2020 20:48	24/12/2020 11:20	14,54	2	29,08	CHI
202012135240	COCALZINHO DE GOIAS	SN12246920	AGUAS LINDAS DE GOIAS S2	23/12/2020 20:49	23/12/2020 23:31	23/12/2020 20:49	23/12/2020 23:31	2,69	5	13,46	CHI
202012135240	SANTO ANTONIO DO DESCOBERTO	SN12246920	AGUAS LINDAS DE GOIAS S2	23/12/2020 20:49	23/12/2020 23:31	23/12/2020 20:49	23/12/2020 23:31	2,69	20	53,82	CHI
202012135249	NOVA CRIXAS	NA12313412	NOVA CRIXAS	23/12/2020 20:51	24/12/2020 08:52	23/12/2020 20:51	24/12/2020 08:52	12,00	1	12,00	CHI
202012135256	MINEIROS	MY13290181	PARQUE DAS EMAS	23/12/2020 20:54	23/12/2020 22:45	23/12/2020 20:54	23/12/2020 22:45	1,84	120	220,97	CHI
202012135274	CORUMBAIBA	CI12363786	VILA CORUMBA	23/12/2020 20:55	24/12/2020 12:06	23/12/2020 20:55	24/12/2020 12:06	15,17	18	273,08	CHI
202012135278	JATAI	MY10409364	PARQUE DAS EMAS	23/12/2020 20:55	23/12/2020 23:56	23/12/2020 20:55	23/12/2020 23:56	3,01	29	87,22	CHI
202012135278	MINEIROS	MY10409364	PARQUE DAS EMAS	23/12/2020 20:55	23/12/2020 23:56	23/12/2020 20:55	23/12/2020 23:56	3,01	30	90,23	CHI
202012135278	PEROLANDIA	MY10409364	PARQUE DAS EMAS	23/12/2020 20:55	23/12/2020 23:56	23/12/2020 20:55	23/12/2020 23:56	3,01	19	57,14	CHI
202012135992	APORE	O4320224	ITAJA S1	23/12/2020 20:57	24/12/2020 10:27	24/12/2020 05:28	24/12/2020 10:27	4,98	55	274,11	CHI
202012135291	JATAI	JT12205180	JATAI S1	23/12/2020 21:03	24/12/2020 12:06	23/12/2020 21:03	24/12/2020 12:06	15,05	3	45,14	CHI
202012135294	FAINA	FC12386403	GOIAS	23/12/2020 21:03	24/12/2020 11:03	23/12/2020 21:03	24/12/2020 11:03	13,99	4	55,94	CHI
202012135305	JATAI	JT12159407	JATAI S1	23/12/2020 21:05	24/12/2020 08:51	23/12/2020 21:05	24/12/2020 08:51	11,76	3	35,27	CHI
202012136071	CORUMBAIBA	CI12263856	VILA CORUMBA	23/12/2020 21:07	24/12/2020 11:44	23/12/2020 21:07	24/12/2020 11:44	14,62	168	2455,51	CHI
202012136071	NOVA AURORA	CI12263856	VILA CORUMBA	23/12/2020 21:07	24/12/2020 11:44	23/12/2020 21:07	24/12/2020 11:44	14,62	7	102,31	CHI
202012135356	CACHOEIRA ALTA	00270434	CACHOEIRA ALTA	23/12/2020 21:09	26/12/2020 00:17	23/12/2020 21:09	23/12/2020 22:22	1,21	7	8,47	CHI
202012135356	CACU	00270434	CACHOEIRA ALTA	23/12/2020 21:09	26/12/2020 00:17	23/12/2020 21:09	23/12/2020 22:22	1,21	3	3,63	CHI
202012135356	CACHOEIRA ALTA	00270434	CACHOEIRA ALTA	23/12/2020 21:09	26/12/2020 00:17	24/12/2020 00:22	24/12/2020 00:28	0,09	8	0,74	CHI
202012135356	CACU	00270434	CACHOEIRA ALTA	23/12/2020 21:09	26/12/2020 00:17	24/12/2020 00:22	24/12/2020 00:28	0,09	3	0,28	CHI
202012135356	LAGOA SANTA	LS10414903	ITAJA S2	23/12/2020 21:09	26/12/2020 00:17	23/12/2020 21:09	24/12/2020 00:36	3,44	17	58,52	CHI
202012135356	DISTRITO FEDERAL	LS10414903	ITAJA S2	23/12/2020 21:09	26/12/2020 00:17	23/12/2020 21:09	24/12/2020 00:36	3,44	1	3,44	CHI
202012135356	CACU	00270434	CACHOEIRA ALTA	23/12/2020 21:09	26/12/2020 00:17	24/12/2020 03:16	24/12/2020 03:25	0,15	3	0,46	CHI
202012135356	CACHOEIRA ALTA	00270434	CACHOEIRA ALTA	23/12/2020 21:09	26/12/2020 00:17	24/12/2020 03:16	24/12/2020 03:25	0,15	8	1,21	CHI
202012135356	CACU	00270434	CACHOEIRA ALTA	23/12/2020 21:09	26/12/2020 00:17	24/12/2020 08:37	24/12/2020 09:01	0,40	3	1,19	CHI
202012135356	CACHOEIRA ALTA	00270434	CACHOEIRA ALTA	23/12/2020 21:09	26/12/2020 00:17	24/12/2020 08:37	24/12/2020 09:01	0,40	8	3,16	CHI
202012135356	ITARUMA	00270434	CACHOEIRA ALTA	23/12/2020 21:09	26/12/2020 00:17	23/12/2020 21:09	24/12/2020 14:17	17,13	45	770,91	CHI
202012135356	LAGOA SANTA	00270434	CACHOEIRA ALTA	23/12/2020 21:09	26/12/2020 00:17	23/12/2020 21:09	24/12/2020 14:17	17,13	12	205,58	CHI
202012135356	ITAJA	00270434	CACHOEIRA ALTA	23/12/2020 21:09	26/12/2020 00:17	23/12/2020 21:09	24/12/2020 14:17	17,13	12	205,58	CHI
202012135356	LAGOA SANTA	00270434	CACHOEIRA ALTA	23/12/2020 21:09	26/12/2020 00:17	24/12/2020 00:22	24/12/2020 14:17	13,91	2	27,82	CHI
202012135356	LAGOA SANTA	00270434	CACHOEIRA ALTA	23/12/2020 21:09	26/12/2020 00:17	24/12/2020 17:48	24/12/2020 17:57	0,14	14	2,01	CHI
202012135356	ITAJA	00270434	CACHOEIRA ALTA	23/12/2020 21:09	26/12/2020 00:17	24/12/2020 17:48	24/12/2020 17:57	0,14	12	1,72	CHI
202012135356	CACU	00270434	CACHOEIRA ALTA	23/12/2020 21:09	26/12/2020 00:17	24/12/2020 17:48	24/12/2020 17:57	0,14	55	7,88	CHI
202012135356	CACU	00270434	CACHOEIRA ALTA	23/12/2020 21:09	26/12/2020 00:17	24/12/2020 17:48	24/12/2020 17:57	0,14	3	0,43	CHI
202012135356	CACHOEIRA ALTA	00270434	CACHOEIRA ALTA	23/12/2020 21:09	26/12/2020 00:17	24/12/2020 17:48	24/12/2020 17:57	0,14	8	1,15	CHI
202012135356	ITARUMA	00270434	CACHOEIRA ALTA	23/12/2020 21:09	26/12/2020 00:17	24/12/2020 17:48	24/12/2020 17:57	0,14	45	6,45	CHI
202012135356	ITARUMA	00270434	CACHOEIRA ALTA	23/12/2020 21:09	26/12/2020 00:17	24/12/2020 17:48	24/12/2020 17:57	0,14	80	11,47	CHI
202012135356	ITAJA	00270434	CACHOEIRA ALTA	23/12/2020 21:09	26/12/2020 00:17	24/12/2020 17:48	24/12/2020 17:57	0,14	7	1,00	CHI
202012135356	ITAJA	00270434	CACHOEIRA ALTA	23/12/2020 21:09	26/12/2020 00:17	23/12/2020 21:09	24/12/2020 22:08	24,97	19	474,45	CHI
202012135356	LAGOA SANTA	00270434	CACHOEIRA ALTA	23/12/2020 21:09	26/12/2020 00:17	23/12/2020 21:09	24/12/2020 22:08	24,97	73	1822,87	CHI

202012135356	LAGOA SANTA	IJ13110421	CACHOEIRA ALTA	23/12/2020 21:09	26/12/2020 00:17	24/12/2020 17:48	24/12/2020 22:08	4,32	1	4,32	CHI
202012135356	CACU	00270434	CACHOEIRA ALTA	23/12/2020 21:09	26/12/2020 00:17	25/12/2020 01:05	25/12/2020 01:17	0,20	55	10,95	CHI
202012135356	LAGOA SANTA	00270434	CACHOEIRA ALTA	23/12/2020 21:09	26/12/2020 00:17	25/12/2020 01:05	25/12/2020 01:17	0,20	14	2,79	CHI
202012135356	CACHOEIRA ALTA	00270434	CACHOEIRA ALTA	23/12/2020 21:09	26/12/2020 00:17	25/12/2020 01:05	25/12/2020 01:17	0,20	8	1,59	CHI
202012135356	CACU	00270434	CACHOEIRA ALTA	23/12/2020 21:09	26/12/2020 00:17	25/12/2020 01:05	25/12/2020 01:17	0,20	3	0,60	CHI
202012135356	ITAJA	00270434	CACHOEIRA ALTA	23/12/2020 21:09	26/12/2020 00:17	25/12/2020 01:05	25/12/2020 01:17	0,20	7	1,39	CHI
202012135356	ITAJA	00270434	CACHOEIRA ALTA	23/12/2020 21:09	26/12/2020 00:17	25/12/2020 01:05	25/12/2020 01:17	0,20	12	2,39	CHI
202012135356	ITARUMA	00270434	CACHOEIRA ALTA	23/12/2020 21:09	26/12/2020 00:17	25/12/2020 01:05	25/12/2020 01:17	0,20	60	11,95	CHI
202012135356	ITARUMA	00270434	CACHOEIRA ALTA	23/12/2020 21:09	26/12/2020 00:17	25/12/2020 01:05	25/12/2020 01:17	0,20	45	8,96	CHI
202012135356	CACU	00270434	CACHOEIRA ALTA	23/12/2020 21:09	26/12/2020 00:17	23/12/2020 21:09	25/12/2020 21:35	48,43	4	193,72	CHI
202012135356	ITAJA	00270434	CACHOEIRA ALTA	23/12/2020 21:09	26/12/2020 00:17	23/12/2020 21:09	25/12/2020 21:35	48,43	3	145,29	CHI
202012135356	ITAJA	00270434	CACHOEIRA ALTA	23/12/2020 21:09	26/12/2020 00:17	23/12/2020 21:09	25/12/2020 21:35	48,43	31	1501,35	CHI
202012135356	ITARUMA	00270434	CACHOEIRA ALTA	23/12/2020 21:09	26/12/2020 00:17	23/12/2020 21:09	25/12/2020 21:35	48,43	116	5617,94	CHI
202012135356	ITARUMA	00270434	CACHOEIRA ALTA	23/12/2020 21:09	26/12/2020 00:17	24/12/2020 17:48	25/12/2020 21:35	27,78	14	388,96	CHI
202012135356	LAGOA SANTA	IJ13110421	CACHOEIRA ALTA	23/12/2020 21:09	26/12/2020 00:17	26/12/2020 00:12	26/12/2020 00:17	0,08	85	6,40	CHI
202012135356	ITAJA	IJ13110421	CACHOEIRA ALTA	23/12/2020 21:09	26/12/2020 00:17	26/12/2020 00:12	26/12/2020 00:17	0,08	71	5,34	CHI
202012135318	NOVO GAMA	NJ11276292	PACAEMBU S2	23/12/2020 21:10	23/12/2020 23:52	23/12/2020 21:10	23/12/2020 23:52	2,69	2	5,39	CHI
202012135339	GOIANIA	GN11169412	ATLANTICO S2	23/12/2020 21:17	24/12/2020 01:55	23/12/2020 21:17	24/12/2020 01:55	4,63	42	194,48	CHI
202012139089	VILA PROPICIO	BA12163310	GOIANESIA S1	23/12/2020 21:17	25/12/2020 03:06	23/12/2020 21:17	25/12/2020 03:06	29,81	11	327,92	CHI
202012139089	GOIANESIA	BA12163310	GOIANESIA S1	23/12/2020 21:17	25/12/2020 03:06	23/12/2020 21:17	25/12/2020 03:06	29,81	2	59,62	CHI
202012135500	LAGOA SANTA	LS12172747	ITAJA S2	23/12/2020 21:18	24/12/2020 02:40	23/12/2020 21:18	24/12/2020 02:40	5,36	271	1453,09	CHI
202012136165	MINEIROS	MY12248429	PARQUE DAS EMAS	23/12/2020 21:18	24/12/2020 19:22	23/12/2020 21:18	24/12/2020 19:22	22,06	18	397,06	CHI
202012135586	GOIANDIRA	GD12000006	CATALAO S1	23/12/2020 21:19	24/12/2020 01:33	23/12/2020 21:19	24/12/2020 01:33	4,22	320	1351,82	CHI
202012136090	ITAJA	AE12107317LD	ITAJA S1	23/12/2020 21:19	24/12/2020 13:31	23/12/2020 21:19	24/12/2020 13:31	16,19	1	16,19	CHI
202012136090	APORE	AE12107317LD	ITAJA S1	23/12/2020 21:19	24/12/2020 13:31	23/12/2020 21:19	24/12/2020 13:31	16,19	78	1263,06	CHI
202012136090	ITARUMA	AE12107317LD	ITAJA S1	23/12/2020 21:19	24/12/2020 13:31	23/12/2020 21:19	24/12/2020 13:31	16,19	1	16,19	CHI
202012135367	JARAGUA	70070787	JARAGUA	23/12/2020 21:24	24/12/2020 16:51	23/12/2020 21:24	24/12/2020 16:51	19,46	1	19,46	CHI
202012135604	JATAI	JT12260493	JATAI S1	23/12/2020 21:24	24/12/2020 09:10	23/12/2020 21:24	24/12/2020 09:10	11,76	18	211,73	CHI
202012135385	MOZARLANDIA	CX12063689LD	MOZARLANDIA	23/12/2020 21:26	24/12/2020 18:30	23/12/2020 21:26	24/12/2020 16:04	18,63	5	93,15	CHI
202012135385	CRIXAS	CX12063689LD	MOZARLANDIA	23/12/2020 21:26	24/12/2020 18:30	23/12/2020 21:26	24/12/2020 16:04	18,63	5	93,15	CHI
202012135385	CRIXAS	CX12063689LD	MOZARLANDIA	23/12/2020 21:26	24/12/2020 18:30	24/12/2020 14:26	24/12/2020 16:04	1,64	2	3,27	CHI
202012135385	MOZARLANDIA	CX12063689LD	MOZARLANDIA	23/12/2020 21:26	24/12/2020 18:30	24/12/2020 16:05	24/12/2020 17:44	1,64	5	8,20	CHI
202012135385	CRIXAS	CX12063689LD	MOZARLANDIA	23/12/2020 21:26	24/12/2020 18:30	24/12/2020 16:05	24/12/2020 17:44	1,64	5	8,20	CHI
202012135385	CRIXAS	CX12063689LD	MOZARLANDIA	23/12/2020 21:26	24/12/2020 18:30	24/12/2020 16:05	24/12/2020 18:30	2,41	2	4,83	CHI
202012135385	MOZARLANDIA	CX12063689LD	MOZARLANDIA	23/12/2020 21:26	24/12/2020 18:30	24/12/2020 17:51	24/12/2020 18:30	0,64	5	3,22	CHI
202012135385	CRIXAS	CX12063689LD	MOZARLANDIA	23/12/2020 21:26	24/12/2020 18:30	24/12/2020 17:51	24/12/2020 18:30	0,64	5	3,22	CHI
202012135382	ANICUNS	AC21019286	ANICUNS	23/12/2020 21:27	24/12/2020 04:30	23/12/2020 21:27	24/12/2020 04:30	7,06	2	14,11	CHI
202012135383	BURITINOPOLIS	BQ12344370RE	IACIARA S2	23/12/2020 21:27	24/12/2020 12:39	23/12/2020 21:27	24/12/2020 03:08	5,69	158	899,28	CHI
202012135383	MAMBAI	BQ12344370RE	IACIARA S2	23/12/2020 21:27	24/12/2020 12:39	23/12/2020 21:27	24/12/2020 03:08	5,69	1	5,69	CHI
202012135383	BURITINOPOLIS	BQ12190580LD	IACIARA S2	23/12/2020 21:27	24/12/2020 12:39	23/12/2020 21:27	24/12/2020 08:38	11,19	75	839,31	CHI
202012135383	BURITINOPOLIS	BQ12190586	IACIARA S2	23/12/2020 21:27	24/12/2020 12:39	23/12/2020 21:27	24/12/2020 09:03	11,60	14	162,37	CHI
202012135383	BURITINOPOLIS	BQ12190575LD	IACIARA S2	23/12/2020 21:27	24/12/2020 12:39	23/12/2020 21:27	24/12/2020 12:39	15,21	12	182,48	CHI
202012136688	VIANOPOLIS	VN12282733	VIANOPOLIS	23/12/2020 21:29	24/12/2020 10:03	23/12/2020 21:29	24/12/2020 10:03	12,56	9	113,06	CHI
202012135426	PORTELANDIA	PW11341122	PARQUE DAS EMAS	23/12/2020 21:37	24/12/2020 12:30	23/12/2020 21:37	24/12/2020 12:30	14,88	55	818,42	CHI
202012135450	QUIRINOPOLIS	QI12279796RE	QUIRINOPOLIS	23/12/2020 21:44	24/12/2020 00:50	23/12/2020 21:44	24/12/2020 00:50	3,09	14	43,33	CHI
202012135499	PORANGATU	PO12020578	PORANGATU	23/12/2020 21:44	25/12/2020 16:20	23/12/2020 21:44	24/12/2020 08:18	10,57	14	147,93	CHI
202012135499	PORANGATU	PO13375469	PORANGATU	23/12/2020 21:44	25/12/2020 16:20	23/12/2020 21:44	24/12/2020 15:25	17,67	8	141,38	CHI
202012135499	PORANGATU	7808586	PORANGATU	23/12/2020 21:44	25/12/2020 16:20	23/12/2020 21:44	25/12/2020 16:20	42,59	1	42,59	CHI
202012135455	ACREUNA	EU21355957	ACREUNA	23/12/2020 21:46	24/12/2020 02:15	23/12/2020 21:46	24/12/2020 02:15	4,49	1	4,49	CHI
202012135490	MINEIROS	1390094495	PARQUE DAS EMAS	23/12/2020 21:56	24/12/2020 07:36	23/12/2020 21:56	24/12/2020 07:36	9,66	1	9,66	CHI
202012135629	ITABERAI	IB12088183	ITABERAI S2	23/12/2020 21:56	24/12/2020 01:54	23/12/2020 21:56	24/12/2020 01:54	3,95	4	15,81	CHI



202012135509	PONTALINA	PK12047065	PONTALINA	23/12/2020 22:02	24/12/2020 07:57	23/12/2020 22:02	24/12/2020 07:57	9,92	10	99,16	CHI
202012135519	SAO LUIS DE MONTES BELOS	SL12167244	FIRMINOPOLIS S2	23/12/2020 22:10	24/12/2020 00:32	23/12/2020 22:10	24/12/2020 00:32	2,35	2	4,70	CHI
202012135588	PLANALTINA	PI12085571	PLANALTINA	23/12/2020 22:11	24/12/2020 01:18	23/12/2020 22:11	24/12/2020 01:18	3,10	42	130,22	CHI
202012136245	JATAI	JT12182190	JATAI S1	23/12/2020 22:11	24/12/2020 08:51	23/12/2020 22:11	24/12/2020 08:51	10,66	21	223,81	CHI
202012135525	SANTA FE DE GOIAS	RN12055147	BRITANIA	23/12/2020 22:13	24/12/2020 08:56	23/12/2020 22:13	24/12/2020 08:56	10,71	3	32,12	CHI
202012135584	CORREGO DO OURO	CO12003798	SAO LUIZ DOS MONTES BELOS	23/12/2020 22:13	24/12/2020 02:00	23/12/2020 22:13	24/12/2020 02:00	3,78	57	215,19	CHI
202012135577	IVOLANDIA	AY10349667	ARENOPOLIS	23/12/2020 22:24	24/12/2020 01:18	23/12/2020 22:24	24/12/2020 01:18	2,91	100	291,42	CHI
202012135577	MONTES CLAROS DE GOIAS	AY10349667	ARENOPOLIS	23/12/2020 22:24	24/12/2020 01:18	23/12/2020 22:24	24/12/2020 01:18	2,91	41	119,48	CHI
202012135577	IPORA	AY10349667	ARENOPOLIS	23/12/2020 22:24	24/12/2020 01:18	23/12/2020 22:24	24/12/2020 01:18	2,91	162	472,10	CHI
202012135577	DIORAMA	AY10349667	ARENOPOLIS	23/12/2020 22:24	24/12/2020 01:18	23/12/2020 22:24	24/12/2020 01:18	2,91	149	434,21	CHI
202012135577	PALESTINA DE GOIAS	AY10349667	ARENOPOLIS	23/12/2020 22:24	24/12/2020 01:18	23/12/2020 22:24	24/12/2020 01:18	2,91	52	151,54	CHI
202012135577	ARENOPOLIS	AY10349667	ARENOPOLIS	23/12/2020 22:24	24/12/2020 01:18	23/12/2020 22:24	24/12/2020 01:18	2,91	212	617,80	CHI
202012135561	PLANALTINA	TL12383351	SAO JOAO D ALIANCA	23/12/2020 22:25	24/12/2020 09:52	23/12/2020 22:25	24/12/2020 09:52	11,44	4	45,74	CHI
202012135561	AGUA FRIA DE GOIAS	TL12383351	SAO JOAO D ALIANCA	23/12/2020 22:25	24/12/2020 09:52	23/12/2020 22:25	24/12/2020 09:52	11,44	1	11,44	CHI
202012135563	SAO LUIS DE MONTES BELOS	SL12383600	SAO LUIZ DOS MONTES BELOS	23/12/2020 22:26	24/12/2020 04:25	23/12/2020 22:26	24/12/2020 04:25	5,99	9	53,90	CHI
202012135570	AMORINOPOLIS	AM12079563	IPORA	23/12/2020 22:26	24/12/2020 08:46	23/12/2020 22:26	24/12/2020 08:46	10,34	3	31,01	CHI
202012135596	ITAJA	IJ12200700	ITAJA S2	23/12/2020 22:40	24/12/2020 19:38	23/12/2020 22:40	24/12/2020 19:38	9,58	1	9,58	CHI
202012135596	ITAJA	IJ21000004	ITAJA S2	23/12/2020 22:40	24/12/2020 19:38	24/12/2020 08:24	24/12/2020 19:24	11,00	1	11,00	CHI
202012135596	ITAJA	IJ12200700	ITAJA S2	23/12/2020 22:40	24/12/2020 19:38	24/12/2020 08:24	24/12/2020 19:38	11,23	0	0,00	CHI
202012135643	IPAMERI	KR10413321	CRISTALINA S2	23/12/2020 22:50	25/12/2020 15:06	23/12/2020 22:50	23/12/2020 22:57	0,13	100	12,75	CHI
202012135643	CRISTALINA	KR10413321	CRISTALINA S2	23/12/2020 22:50	25/12/2020 15:06	23/12/2020 22:50	23/12/2020 22:57	0,13	66	8,41	CHI
202012135643	CRISTALINA	KR10414293	CRISTALINA S2	23/12/2020 22:50	25/12/2020 15:06	23/12/2020 22:50	23/12/2020 22:58	0,14	37	5,15	CHI
202012135643	CRISTALINA	KR10413345	CRISTALINA S2	23/12/2020 22:50	25/12/2020 15:06	23/12/2020 22:50	24/12/2020 19:57	21,12	1	21,12	CHI
202012135643	LUZIANIA	03470464	CRISTALINA S2	23/12/2020 22:50	25/12/2020 15:06	25/12/2020 14:51	25/12/2020 14:55	0,07	31	2,14	CHI
202012135643	CRISTALINA	KR10400735	CRISTALINA S2	23/12/2020 22:50	25/12/2020 15:06	25/12/2020 14:51	25/12/2020 14:55	0,07	135	9,34	CHI
202012135643	LUZIANIA	KR10400735	CRISTALINA S2	23/12/2020 22:50	25/12/2020 15:06	25/12/2020 14:51	25/12/2020 14:55	0,07	218	15,08	CHI
202012135643	CRISTALINA	03470464	CRISTALINA S2	23/12/2020 22:50	25/12/2020 15:06	25/12/2020 14:51	25/12/2020 14:55	0,07	428	29,60	CHI
202012135643	CRISTALINA	KR10414277	CRISTALINA S2	23/12/2020 22:50	25/12/2020 15:06	25/12/2020 14:51	25/12/2020 15:05	0,23	95	22,01	CHI
202012135643	CRISTALINA	KR10413325	CRISTALINA S2	23/12/2020 22:50	25/12/2020 15:06	25/12/2020 14:57	25/12/2020 15:05	0,13	3	0,39	CHI
202012135643	LUZIANIA	01090414	CRISTALINA S2	23/12/2020 22:50	25/12/2020 15:06	25/12/2020 14:57	25/12/2020 15:05	0,14	267	36,49	CHI
202012135643	CRISTALINA	LZ10407611	CRISTALINA S2	23/12/2020 22:50	25/12/2020 15:06	25/12/2020 14:57	25/12/2020 15:05	0,14	135	18,45	CHI
202012135643	CRISTALINA	01090414	CRISTALINA S2	23/12/2020 22:50	25/12/2020 15:06	25/12/2020 14:57	25/12/2020 15:05	0,14	452	61,77	CHI
202012135643	LUZIANIA	LZ10407611	CRISTALINA S2	23/12/2020 22:50	25/12/2020 15:06	25/12/2020 14:57	25/12/2020 15:06	0,15	219	32,79	CHI
202012135639	ANICUNS	AC12306940	ANICUNS	23/12/2020 23:00	24/12/2020 05:13	23/12/2020 23:00	24/12/2020 05:13	6,20	33	204,70	CHI
202012135639	ITABERAI	AC12306940	ANICUNS	23/12/2020 23:00	24/12/2020 05:13	23/12/2020 23:00	24/12/2020 05:13	6,20	2	12,41	CHI
202012137156	SAO LUIS DE MONTES BELOS	SC12299040	FIRMINOPOLIS S2	23/12/2020 23:01	24/12/2020 09:17	23/12/2020 23:01	24/12/2020 09:17	10,25	46	471,68	CHI
202012137156	SANCLERLANDIA	SC12299040	FIRMINOPOLIS S2	23/12/2020 23:01	24/12/2020 09:17	23/12/2020 23:01	24/12/2020 09:17	10,25	1	10,25	CHI
202012135683	SANCLERLANDIA	SL12019284	SAO LUIZ DOS MONTES BELOS	23/12/2020 23:10	24/12/2020 08:07	23/12/2020 23:10	24/12/2020 07:51	8,67	4	34,68	CHI
202012135683	SAO LUIS DE MONTES BELOS	SL12019284	SAO LUIZ DOS MONTES BELOS	23/12/2020 23:10	24/12/2020 08:07	23/12/2020 23:10	24/12/2020 07:51	8,67	11	95,37	CHI
202012135683	SAO LUIS DE MONTES BELOS	SL12019284	SAO LUIZ DOS MONTES BELOS	23/12/2020 23:10	24/12/2020 08:07	23/12/2020 23:10	24/12/2020 08:04	8,89	25	222,28	CHI
202012135683	SANCLERLANDIA	SL12019284	SAO LUIZ DOS MONTES BELOS	23/12/2020 23:10	24/12/2020 08:07	23/12/2020 23:10	24/12/2020 08:04	8,89	23	204,50	CHI
202012135683	SAO LUIS DE MONTES BELOS	SL12019284	SAO LUIZ DOS MONTES BELOS	23/12/2020 23:10	24/12/2020 08:07	23/12/2020 23:10	24/12/2020 08:07	8,95	22	196,84	CHI
202012135752	GOIANIA	GN12269050	CARAIAS S2	23/12/2020 23:14	24/12/2020 02:31	23/12/2020 23:14	24/12/2020 02:31	3,28	366	1201,90	CHI
202012136260	MARA ROSA	MQ12028228	MARA ROSA	23/12/2020 23:21	24/12/2020 11:27	23/12/2020 23:21	24/12/2020 11:27	12,09	16	193,49	CHI
202012135694	MAIRIPOTABA	MI12011393	PONTALINA	23/12/2020 23:31	24/12/2020 03:26	23/12/2020 23:31	24/12/2020 03:26	3,91	34	133,01	CHI
202012136909	APORE	AE12188958	ITAJA S2	23/12/2020 23:41	24/12/2020 16:27	23/12/2020 23:41	24/12/2020 16:27	16,76	8	134,08	CHI
202012137121	GOIATUBA	GT12044907	GOIATUBA S2	23/12/2020 23:48	24/12/2020 11:44	23/12/2020 23:48	24/12/2020 11:44	11,92	14	166,85	CHI
202012135733	CACHOEIRA DOURADA	CD11000013	CACHOEIRA DOURADA	23/12/2020 23:51	24/12/2020 18:46	24/12/2020 12:47	24/12/2020 16:02	3,25	175	569,53	CHI
202012135733	CACHOEIRA DOURADA	CD12389716	CACHOEIRA DOURADA	23/12/2020 23:51	24/12/2020 18:46	23/12/2020 23:51	24/12/2020 18:39	18,79	93	1747,50	CHI
202012135733	CACHOEIRA DOURADA	CD11000013	CACHOEIRA DOURADA	23/12/2020 23:51	24/12/2020 18:46	24/12/2020 17:24	24/12/2020 18:46	1,38	175	241,06	CHI
202012135734	BURITI ALEGRE	420028833	ITUMBIAIRA VELHA S2	23/12/2020 23:53	24/12/2020 08:00	23/12/2020 23:53	24/12/2020 08:00	8,11	1	8,11	CHI

202012135739	APARECIDA DE GOIANIA	AP11245676	REAL S1	24/12/2020 00:00	24/12/2020 07:31	24/12/2020 00:00	24/12/2020 07:31	7,50	95	712,95	CHI
202012136696	CAMPINORTE	NH12070624	CAMPINORTE	24/12/2020 00:00	24/12/2020 11:47	24/12/2020 00:00	24/12/2020 11:47	11,78	4	47,11	CHI
202012136696	NOVA IGUAÇU DE GOIAS	NH12070624	CAMPINORTE	24/12/2020 00:00	24/12/2020 11:47	24/12/2020 00:00	24/12/2020 11:47	11,78	8	94,22	CHI
202012136176	MAURILANDIA	6395653	SANTA HELENA S1	24/12/2020 00:04	24/12/2020 09:03	24/12/2020 00:04	24/12/2020 09:03	8,98	29	260,34	CHI
202012136176	RIO VERDE	6395653	SANTA HELENA S1	24/12/2020 00:04	24/12/2020 09:03	24/12/2020 00:04	24/12/2020 09:03	8,98	15	134,66	CHI
202012136176	SANTA HELENA DE GOIAS	6395653	SANTA HELENA S1	24/12/2020 00:04	24/12/2020 09:03	24/12/2020 00:04	24/12/2020 09:03	8,98	3	26,93	CHI
202012135748	SILVANIA	SV12161967	VIANOPOLIS	24/12/2020 00:06	24/12/2020 04:53	24/12/2020 00:06	24/12/2020 04:53	4,77	14	66,76	CHI
202012136015	PARAUNA	PU12079039	PARAUNA	24/12/2020 00:14	24/12/2020 09:25	24/12/2020 00:14	24/12/2020 09:25	9,17	38	348,64	CHI
202012137566	PETROLINA DE GOIAS	PG12050780	PETROLINA	24/12/2020 00:14	24/12/2020 11:51	24/12/2020 00:14	24/12/2020 11:51	11,61	6	69,68	CHI
202012135987	MINEIROS	MY12274100RE	PARQUE DAS EMAS	24/12/2020 00:23	24/12/2020 17:41	24/12/2020 00:23	24/12/2020 17:41	17,29	16	276,59	CHI
202012135771	JANDAIA	JD12008612	PALMEIRAS	24/12/2020 00:24	24/12/2020 06:07	24/12/2020 00:24	24/12/2020 06:07	5,70	10	57,00	CHI
202012135786	ORIZONA	OZ11140712	PIRES DO RIO S2	24/12/2020 00:37	24/12/2020 06:35	24/12/2020 00:37	24/12/2020 06:35	5,95	149	886,67	CHI
202012136565	MINEIROS	MY12202613RE	PARQUE DAS EMAS	24/12/2020 00:43	27/12/2020 12:50	24/12/2020 00:43	24/12/2020 20:50	20,12	10	201,22	CHI
202012136565	MINEIROS	MY12202613RE	PARQUE DAS EMAS	24/12/2020 00:43	27/12/2020 12:50	24/12/2020 20:51	24/12/2020 22:39	1,80	5	8,98	CHI
202012136565	MINEIROS	MY12202613RE	PARQUE DAS EMAS	24/12/2020 00:43	27/12/2020 12:50	24/12/2020 22:42	26/12/2020 15:30	40,80	1	40,80	CHI
202012136565	MINEIROS	MY12202613RE	PARQUE DAS EMAS	24/12/2020 00:43	27/12/2020 12:50	24/12/2020 22:42	26/12/2020 15:45	41,04	1	41,04	CHI
202012136565	MINEIROS	MY12114018	PARQUE DAS EMAS	24/12/2020 00:43	27/12/2020 12:50	26/12/2020 18:51	26/12/2020 23:30	4,65	46	213,71	CHI
202012136565	MINEIROS	MY12114018	PARQUE DAS EMAS	24/12/2020 00:43	27/12/2020 12:50	27/12/2020 10:06	27/12/2020 12:47	2,68	47	126,06	CHI
202012136565	MINEIROS	MY12202613RE	PARQUE DAS EMAS	24/12/2020 00:43	27/12/2020 12:50	24/12/2020 20:51	27/12/2020 12:50	63,98	5	319,90	CHI
202012136565	MINEIROS	MY12202613RE	PARQUE DAS EMAS	24/12/2020 00:43	27/12/2020 12:50	24/12/2020 22:42	27/12/2020 12:50	62,13	3	186,38	CHI
202012136565	MINEIROS	MY12202613RE	PARQUE DAS EMAS	24/12/2020 00:43	27/12/2020 12:50	26/12/2020 23:30	27/12/2020 12:50	13,34	2	26,68	CHI
202012135791	FORMOSA	FA12404372	ITUIQUIRA	24/12/2020 00:44	24/12/2020 09:10	24/12/2020 00:44	24/12/2020 09:10	8,43	166	1398,73	CHI
202012135898	NAZARIO	NZ12003900	ANICUNS	24/12/2020 00:58	24/12/2020 09:08	24/12/2020 00:58	24/12/2020 09:08	8,16	12	97,91	CHI
202012136732	SANTO ANTONIO DO DESCOBERTO	AX12000057	ALEXANIA	24/12/2020 01:04	24/12/2020 18:47	24/12/2020 01:04	24/12/2020 18:47	17,72	1	17,72	CHI
202012136732	ALEXANIA	AX12000057	ALEXANIA	24/12/2020 01:04	24/12/2020 18:47	24/12/2020 01:04	24/12/2020 18:47	17,72	10	177,16	CHI
202012135816	CACU	CC21161598	CACHOEIRA ALTA	24/12/2020 01:10	24/12/2020 10:35	24/12/2020 01:10	24/12/2020 10:35	9,40	1	9,40	CHI
202012135819	HIDROLANDIA	HD12200115	CEPAIGO S2	24/12/2020 01:20	24/12/2020 08:54	24/12/2020 01:20	24/12/2020 08:54	7,56	9	68,05	CHI
202012136268	MINEIROS	MY12360720RE	PARQUE DAS EMAS	24/12/2020 01:22	24/12/2020 18:01	24/12/2020 01:22	24/12/2020 18:01	16,65	4	66,60	CHI
202012135844	SAO MIGUEL DO ARAGUAIA	SM10396890	SAO MIGUEL DO ARAGUAIA	24/12/2020 01:30	24/12/2020 22:11	24/12/2020 01:30	24/12/2020 07:53	6,38	77	491,62	CHI
202012135844	BONOPOLIS	SM10396890	SAO MIGUEL DO ARAGUAIA	24/12/2020 01:30	24/12/2020 22:11	24/12/2020 01:30	24/12/2020 07:53	6,38	105	670,40	CHI
202012135844	SAO MIGUEL DO ARAGUAIA	SM10396890	SAO MIGUEL DO ARAGUAIA	24/12/2020 01:30	24/12/2020 22:11	24/12/2020 09:25	24/12/2020 09:30	0,08	77	6,40	CHI
202012135844	BONOPOLIS	SM10396890	SAO MIGUEL DO ARAGUAIA	24/12/2020 01:30	24/12/2020 22:11	24/12/2020 09:25	24/12/2020 09:30	0,08	105	8,72	CHI
202012135844	SAO MIGUEL DO ARAGUAIA	SM12000063RE	SAO MIGUEL DO ARAGUAIA	24/12/2020 01:30	24/12/2020 22:11	24/12/2020 01:30	24/12/2020 16:27	14,95	12	179,44	CHI
202012135844	SAO MIGUEL DO ARAGUAIA	SM12000063RE	SAO MIGUEL DO ARAGUAIA	24/12/2020 01:30	24/12/2020 22:11	24/12/2020 01:30	24/12/2020 16:43	15,22	4	60,88	CHI
202012135844	SAO MIGUEL DO ARAGUAIA	SM12000063RE	SAO MIGUEL DO ARAGUAIA	24/12/2020 01:30	24/12/2020 22:11	24/12/2020 01:30	24/12/2020 19:47	18,28	1	18,28	CHI
202012135844	SAO MIGUEL DO ARAGUAIA	SM12000063RE	SAO MIGUEL DO ARAGUAIA	24/12/2020 01:30	24/12/2020 22:11	24/12/2020 01:30	24/12/2020 21:14	19,73	3	59,18	CHI
202012135844	SAO MIGUEL DO ARAGUAIA	SM10396890	SAO MIGUEL DO ARAGUAIA	24/12/2020 01:30	24/12/2020 22:11	24/12/2020 01:30	24/12/2020 22:11	20,67	15	310,09	CHI
2020122400022	IPAMERI	01480414	PIRES DO RIO S2	24/12/2020 01:31	24/12/2020 01:34	24/12/2020 01:31	24/12/2020 01:34	0,05	248	12,40	CHI
2020122400022	URUTAI	01480414	PIRES DO RIO S2	24/12/2020 01:31	24/12/2020 01:34	24/12/2020 01:31	24/12/2020 01:34	0,05	105	5,25	CHI
2020122400022	CAMPO ALEGRE DE GOIAS	01480414	PIRES DO RIO S2	24/12/2020 01:31	24/12/2020 01:34	24/12/2020 01:31	24/12/2020 01:34	0,05	19	0,95	CHI
2020122400022	PIRES DO RIO	01480414	PIRES DO RIO S2	24/12/2020 01:31	24/12/2020 01:34	24/12/2020 01:31	24/12/2020 01:34	0,05	10	0,50	CHI
2020122400022	CRISTALINA	01480414	PIRES DO RIO S2	24/12/2020 01:31	24/12/2020 01:34	24/12/2020 01:31	24/12/2020 01:34	0,05	0	0,00	CHI
2020122400022	ORIZONA	01480414	PIRES DO RIO S2	24/12/2020 01:31	24/12/2020 01:34	24/12/2020 01:31	24/12/2020 01:34	0,05	9	0,45	CHI
202012135840	PETROLINA DE GOIAS	PG10395831	PETROLINA	24/12/2020 01:44	24/12/2020 10:10	24/12/2020 01:50	24/12/2020 08:55	7,08	225	1593,50	CHI
202012135840	PETROLINA DE GOIAS	PG13298099	PETROLINA	24/12/2020 01:44	24/12/2020 10:10	24/12/2020 01:50	24/12/2020 10:10	8,33	105	874,56	CHI
202012135840	JESUPOLIS	PG13298099	PETROLINA	24/12/2020 01:44	24/12/2020 10:10	24/12/2020 01:50	24/12/2020 10:10	8,33	1	8,33	CHI
202012138019	PALMEIRAS DE GOIAS	PL12143287	PALMEIRAS	24/12/2020 01:46	24/12/2020 12:39	24/12/2020 01:46	24/12/2020 12:39	10,88	39	424,42	CHI
202012135839	GUARINOS	CX12322603	SANTA TEREZINHA	24/12/2020 01:56	24/12/2020 08:16	24/12/2020 01:56	24/12/2020 08:16	6,33	3	18,99	CHI
202012135839	CRIXAS	CX12322603	SANTA TEREZINHA	24/12/2020 01:56	24/12/2020 08:16	24/12/2020 01:56	24/12/2020 08:16	6,33	2	12,66	CHI
202012135848	EDEIA	EA16411338	EDEIA	24/12/2020 02:12	24/12/2020 18:41	24/12/2020 02:12	24/12/2020 02:16	0,07	616	40,90	CHI
202012135848	EDEIA	EA16411338	EDEIA	24/12/2020 02:12	24/12/2020 18:41	24/12/2020 02:12	24/12/2020 10:43	8,51	128	1089,32	CHI

202012135848	PONTALINA	EA16411338	EDEIA	24/12/2020 02:12	24/12/2020 18:41	24/12/2020 02:12	24/12/2020 10:43	8,51	1	8,51	CHI
202012135848	INDIARA	EA16411338	EDEIA	24/12/2020 02:12	24/12/2020 18:41	24/12/2020 02:12	24/12/2020 10:43	8,51	11	93,61	CHI
202012135848	EDEALINA	EA16411338	EDEIA	24/12/2020 02:12	24/12/2020 18:41	24/12/2020 02:12	24/12/2020 10:43	8,51	52	442,53	CHI
202012135848	EDEIA	EA16411338	EDEIA	24/12/2020 02:12	24/12/2020 18:41	24/12/2020 02:12	24/12/2020 18:41	16,47	3	49,42	CHI
202012135848	EDEIA	EA10400409	EDEIA	24/12/2020 02:12	24/12/2020 18:41	24/12/2020 18:33	24/12/2020 18:41	0,13	128	16,14	CHI
202012135848	INDIARA	EA10400409	EDEIA	24/12/2020 02:12	24/12/2020 18:41	24/12/2020 18:33	24/12/2020 18:41	0,13	11	1,39	CHI
202012135848	PONTALINA	EA10400409	EDEIA	24/12/2020 02:12	24/12/2020 18:41	24/12/2020 18:33	24/12/2020 18:41	0,13	1	0,13	CHI
202012135848	EDEALINA	EA10400409	EDEIA	24/12/2020 02:12	24/12/2020 18:41	24/12/2020 18:33	24/12/2020 18:41	0,13	52	6,56	CHI
202012136050	MOZARLANDIA	AZ12210560	MOZARLANDIA	24/12/2020 02:20	24/12/2020 07:40	24/12/2020 02:20	24/12/2020 07:40	5,33	1	5,33	CHI
202012136050	ARAGUAPAZ	AZ12210560	MOZARLANDIA	24/12/2020 02:20	24/12/2020 07:40	24/12/2020 02:20	24/12/2020 07:40	5,33	20	106,63	CHI
202012135930	GOIANESIA	GE12384153	GOIANESIA S2	24/12/2020 02:27	24/12/2020 09:24	24/12/2020 02:27	24/12/2020 09:24	6,94	9	62,42	CHI
202012135856	PIRES DO RIO	PR12333485	PIRES DO RIO S2	24/12/2020 02:49	25/12/2020 18:19	24/12/2020 02:49	25/12/2020 16:33	37,72	3	113,16	CHI
202012135856	ORIZONA	PR12333485	PIRES DO RIO S2	24/12/2020 02:49	25/12/2020 18:19	24/12/2020 02:49	25/12/2020 16:33	37,72	5	188,60	CHI
202012135856	PIRES DO RIO	PR12333485	PIRES DO RIO S2	24/12/2020 02:49	25/12/2020 18:19	24/12/2020 02:49	25/12/2020 18:19	39,50	2	79,00	CHI
202012135857	FORMOSO	FO12088777RE	MARA ROSA	24/12/2020 02:50	24/12/2020 05:20	24/12/2020 02:50	24/12/2020 05:20	2,49	33	82,22	CHI
202012135862	CAIAPONIA	CP12151179	CAIAPONIA	24/12/2020 03:02	24/12/2020 07:37	24/12/2020 03:02	24/12/2020 07:37	4,58	88	402,80	CHI
202012136296	CATALAO	GD12127538	CATALAO S1	24/12/2020 03:03	24/12/2020 09:44	24/12/2020 03:03	24/12/2020 09:44	6,68	6	40,08	CHI
202012136296	GOIANDIRA	GD12127538	CATALAO S1	24/12/2020 03:03	24/12/2020 09:44	24/12/2020 03:03	24/12/2020 09:44	6,68	13	86,84	CHI
202012135865	ITARUMA	IM11398174	CACHOEIRA ALTA	24/12/2020 03:07	24/12/2020 10:11	24/12/2020 03:07	24/12/2020 10:11	7,05	1	7,05	CHI
202012135868	ITABERAI	IB12300330	ITABERAI S2	24/12/2020 03:19	24/12/2020 07:51	24/12/2020 03:19	24/12/2020 07:51	4,52	14	63,32	CHI
202012135869	GOIAS	IK12274567	GOIAS	24/12/2020 03:20	24/12/2020 11:21	24/12/2020 03:20	24/12/2020 11:21	8,00	5	40,01	CHI
202012136277	JATAI	CC12235896	CACHOEIRA ALTA	24/12/2020 03:29	24/12/2020 09:25	24/12/2020 03:29	24/12/2020 09:25	5,92	9	53,32	CHI
202012136277	CACU	CC12235896	CACHOEIRA ALTA	24/12/2020 03:29	24/12/2020 09:25	24/12/2020 03:29	24/12/2020 09:25	5,92	17	100,72	CHI
202012135877	PORANGATU	PO12192371	PORANGATU	24/12/2020 03:33	24/12/2020 20:36	24/12/2020 03:33	24/12/2020 20:36	17,05	12	204,57	CHI
202012136470	GOIAS	GS12071232	GOIAS	24/12/2020 03:37	24/12/2020 08:39	24/12/2020 03:37	24/12/2020 08:39	5,03	40	201,14	CHI
202012136077	MINACU	IH12088797	MINACU	24/12/2020 03:41	24/12/2020 09:08	24/12/2020 03:41	24/12/2020 09:08	5,43	179	972,77	CHI
202012136181	AMORINOPOLIS	IR12091436	IPORA	24/12/2020 03:42	24/12/2020 07:42	24/12/2020 03:42	24/12/2020 07:42	3,99	3	11,97	CHI
202012136181	IPORA	IR12091436	IPORA	24/12/2020 03:42	24/12/2020 07:42	24/12/2020 03:42	24/12/2020 07:42	3,99	16	63,83	CHI
202012136184	JANDAIA	JD12008635	PALMEIRAS	24/12/2020 03:49	24/12/2020 17:19	24/12/2020 03:49	24/12/2020 17:19	13,49	12	161,84	CHI
202012135887	NIQUELANDIA	NQ12243364RE	URUACU	24/12/2020 03:51	25/12/2020 16:56	24/12/2020 03:51	25/12/2020 07:36	27,74	5	138,72	CHI
202012135887	NIQUELANDIA	NQ12243364RE	URUACU	24/12/2020 03:51	25/12/2020 16:56	24/12/2020 03:51	25/12/2020 08:10	28,31	8	226,52	CHI
202012135887	NIQUELANDIA	NQ12243364RE	URUACU	24/12/2020 03:51	25/12/2020 16:56	25/12/2020 08:52	25/12/2020 10:27	1,58	13	20,49	CHI
202012135887	NIQUELANDIA	NQ12243364RE	URUACU	24/12/2020 03:51	25/12/2020 16:56	24/12/2020 03:51	25/12/2020 12:39	32,81	6	196,85	CHI
202012135887	NIQUELANDIA	NQ12243364RE	URUACU	24/12/2020 03:51	25/12/2020 16:56	24/12/2020 03:51	25/12/2020 12:57	33,11	2	66,22	CHI
202012135887	NIQUELANDIA	NQ12243364RE	URUACU	24/12/2020 03:51	25/12/2020 16:56	24/12/2020 03:51	25/12/2020 13:16	33,42	2	66,85	CHI
202012135887	MARA ROSA	NQ12243364RE	URUACU	24/12/2020 03:51	25/12/2020 16:56	24/12/2020 03:51	25/12/2020 16:56	37,09	1	37,09	CHI
202012135887	NIQUELANDIA	NQ12243364RE	URUACU	24/12/2020 03:51	25/12/2020 16:56	24/12/2020 03:51	25/12/2020 16:56	37,09	4	148,35	CHI
202012136586	MARA ROSA	MQ12125574	MARA ROSA	24/12/2020 03:51	24/12/2020 11:19	24/12/2020 03:51	24/12/2020 11:19	7,47	12	89,59	CHI
202012136253	MOSSAMEDES	SC12395118	FIRMINOPOLIS S2	24/12/2020 03:52	24/12/2020 09:39	24/12/2020 03:52	24/12/2020 09:39	5,77	5	28,87	CHI
202012136253	SANCLERLANDIA	SC12395118	FIRMINOPOLIS S2	24/12/2020 03:52	24/12/2020 09:39	24/12/2020 03:52	24/12/2020 09:39	5,77	2	11,55	CHI
202012135915	MARA ROSA	LC12189854	MARA ROSA	24/12/2020 04:05	24/12/2020 13:14	24/12/2020 04:05	24/12/2020 13:14	9,13	2	18,27	CHI
202012135915	AMARALINA	LC12189854	MARA ROSA	24/12/2020 04:05	24/12/2020 13:14	24/12/2020 04:05	24/12/2020 13:14	9,13	8	73,07	CHI
202012136124	MINEIROS	SU12402338	SANTA RITA DO ARAGUAIA	24/12/2020 04:05	24/12/2020 10:31	24/12/2020 04:05	24/12/2020 10:31	6,42	11	70,64	CHI
202012136124	SANTA RITA DO ARAGUAIA	SU12402338	SANTA RITA DO ARAGUAIA	24/12/2020 04:05	24/12/2020 10:31	24/12/2020 04:05	24/12/2020 10:31	6,42	34	218,35	CHI
202012135894	GUARANI DE GOIAS	GY12271764	IACIARA S1	24/12/2020 04:06	24/12/2020 08:21	24/12/2020 04:06	24/12/2020 08:21	4,24	4	16,97	CHI
202012136361	GOIAS	NB12092962	MATRINCHA	24/12/2020 04:09	24/12/2020 15:08	24/12/2020 04:09	24/12/2020 15:08	10,98	3	32,95	CHI
202012136361	NOVO BRASIL	NB12092962	MATRINCHA	24/12/2020 04:09	24/12/2020 15:08	24/12/2020 04:09	24/12/2020 15:08	10,98	5	54,91	CHI
202012136361	ITAPIRAPUA	NB12092962	MATRINCHA	24/12/2020 04:09	24/12/2020 15:08	24/12/2020 04:09	24/12/2020 15:08	10,98	1	10,98	CHI
202012135897	IPORA	IR12223066	IPORA	24/12/2020 04:12	24/12/2020 08:20	24/12/2020 04:12	24/12/2020 08:20	4,14	17	70,33	CHI
202012135899	JUSSARA	JR10426589	BRITANIA	24/12/2020 04:14	24/12/2020 19:25	24/12/2020 04:18	24/12/2020 09:30	5,20	251	1305,27	CHI
202012135899	SANTA FE DE GOIAS	JR10426589	BRITANIA	24/12/2020 04:14	24/12/2020 19:25	24/12/2020 04:18	24/12/2020 09:30	5,20	9	46,80	CHI

202012135899	FAZENDA NOVA	JR10426589	BRITANIA	24/12/2020 04:14	24/12/2020 19:25	24/12/2020 04:18	24/12/2020 09:30	5,20	9	46,80	CHI
202012135899	JUSSARA	JR10426589	BRITANIA	24/12/2020 04:14	24/12/2020 19:25	24/12/2020 10:36	24/12/2020 10:52	0,27	251	67,21	CHI
202012135899	FAZENDA NOVA	JR10426589	BRITANIA	24/12/2020 04:14	24/12/2020 19:25	24/12/2020 10:36	24/12/2020 10:52	0,27	9	2,41	CHI
202012135899	SANTA FE DE GOIAS	JR10426589	BRITANIA	24/12/2020 04:14	24/12/2020 19:25	24/12/2020 10:36	24/12/2020 10:52	0,27	9	2,41	CHI
202012135899	JUSSARA	JR16410161	BRITANIA	24/12/2020 04:14	24/12/2020 19:25	24/12/2020 04:18	24/12/2020 12:24	8,10	11	89,12	CHI
202012135899	SANTA FE DE GOIAS	JR10426589	BRITANIA	24/12/2020 04:14	24/12/2020 19:25	24/12/2020 15:05	24/12/2020 15:15	0,17	9	1,53	CHI
202012135899	JUSSARA	JR10426589	BRITANIA	24/12/2020 04:14	24/12/2020 19:25	24/12/2020 15:05	24/12/2020 15:15	0,17	262	44,39	CHI
202012135899	FAZENDA NOVA	JR10426589	BRITANIA	24/12/2020 04:14	24/12/2020 19:25	24/12/2020 15:05	24/12/2020 15:15	0,17	9	1,53	CHI
202012135899	JAUPACI	JR13402995	BRITANIA	24/12/2020 04:14	24/12/2020 19:25	24/12/2020 04:18	24/12/2020 19:19	15,02	2	30,03	CHI
202012135899	JUSSARA	JR16410161	BRITANIA	24/12/2020 04:14	24/12/2020 19:25	24/12/2020 04:18	24/12/2020 19:19	15,02	9	135,16	CHI
202012135899	FAZENDA NOVA	JR16410161	BRITANIA	24/12/2020 04:14	24/12/2020 19:25	24/12/2020 04:18	24/12/2020 19:19	15,02	75	1126,29	CHI
202012135899	JUSSARA	JR13402995	BRITANIA	24/12/2020 04:14	24/12/2020 19:25	24/12/2020 04:18	24/12/2020 19:19	15,02	11	165,19	CHI
202012135899	FAZENDA NOVA	JR13402995	BRITANIA	24/12/2020 04:14	24/12/2020 19:25	24/12/2020 04:18	24/12/2020 19:19	15,02	63	946,09	CHI
202012135899	FAZENDA NOVA	FN12073183	BRITANIA	24/12/2020 04:14	24/12/2020 19:25	24/12/2020 04:18	24/12/2020 19:25	15,12	69	1043,30	CHI
202012135905	PIRACANJUBA	PJ10378311	PIRACANJUBA	24/12/2020 04:22	24/12/2020 04:29	24/12/2020 04:22	24/12/2020 04:26	0,08	367	29,46	CHI
202012135905	PROFESSOR JAMIL SAFADY	PJ10378311	PIRACANJUBA	24/12/2020 04:22	24/12/2020 04:29	24/12/2020 04:22	24/12/2020 04:27	0,10	13	1,25	CHI
202012135905	HIDROLANDIA	PJ10378311	PIRACANJUBA	24/12/2020 04:22	24/12/2020 04:29	24/12/2020 04:22	24/12/2020 04:27	0,10	15	1,44	CHI
202012135905	PIRACANJUBA	PJ10378311	PIRACANJUBA	24/12/2020 04:22	24/12/2020 04:29	24/12/2020 04:22	24/12/2020 04:27	0,10	291	27,97	CHI
202012135905	PIRACANJUBA	PJ10378311	PIRACANJUBA	24/12/2020 04:22	24/12/2020 04:29	24/12/2020 04:22	24/12/2020 04:28	0,11	276	29,29	CHI
202012135905	PIRACANJUBA	PJ10378311	PIRACANJUBA	24/12/2020 04:22	24/12/2020 04:29	24/12/2020 04:22	24/12/2020 04:29	0,12	126	14,84	CHI
202012135901	SILVANIA	SV12383417	DAIA S2	24/12/2020 04:25	24/12/2020 09:26	24/12/2020 04:25	24/12/2020 09:26	5,01	56	280,30	CHI
202012135901	LEOPOLDO DE BULHOES	SV12383417	DAIA S2	24/12/2020 04:25	24/12/2020 09:26	24/12/2020 04:25	24/12/2020 09:26	5,01	3	15,02	CHI
202012135901	BELA VISTA DE GOIAS	SV12383417	DAIA S2	24/12/2020 04:25	24/12/2020 09:26	24/12/2020 04:25	24/12/2020 09:26	5,01	1	5,01	CHI
202012135901	CALDAZINHA	SV12383417	DAIA S2	24/12/2020 04:25	24/12/2020 09:26	24/12/2020 04:25	24/12/2020 09:26	5,01	34	170,18	CHI
202012135903	CRISTALINA	KR12313551	CRISTALINA S2	24/12/2020 04:30	24/12/2020 08:20	24/12/2020 04:30	24/12/2020 08:20	3,83	96	367,84	CHI
202012135906	SANTA RITA DO NOVO DESTINO	DF12194371	BARRO ALTO	24/12/2020 04:33	24/12/2020 08:57	24/12/2020 04:33	24/12/2020 08:57	4,39	32	140,54	CHI
202012135906	BARRO ALTO	DF12194371	BARRO ALTO	24/12/2020 04:33	24/12/2020 08:57	24/12/2020 04:33	24/12/2020 08:57	4,39	67	294,26	CHI
202012136788	CRISTALINA	KR12168494	CRISTALINA S2	24/12/2020 04:41	24/12/2020 09:37	24/12/2020 04:41	24/12/2020 09:37	4,93	19	93,71	CHI
202012135954	RIO QUENTE	RQ12100101RE	RIO QUENTE	24/12/2020 04:42	24/12/2020 07:45	24/12/2020 04:42	24/12/2020 07:45	3,04	44	133,77	CHI
202012135916	PIRANHAS	AY12000027RE	ARENOPOLIS	24/12/2020 04:45	24/12/2020 11:33	24/12/2020 04:45	24/12/2020 11:33	6,79	5	33,96	CHI
202012135916	ARENOPOLIS	AY12000027RE	ARENOPOLIS	24/12/2020 04:45	24/12/2020 11:33	24/12/2020 04:45	24/12/2020 11:33	6,79	39	264,87	CHI
202012135934	PORANGATU	PO12202421	PORANGATU	24/12/2020 04:46	24/12/2020 21:23	24/12/2020 04:46	24/12/2020 21:23	16,60	6	99,62	CHI
202012135921	RUBIATABA	RB12255942	RUBIATABA	24/12/2020 04:49	24/12/2020 09:01	24/12/2020 04:49	24/12/2020 09:01	4,19	50	209,47	CHI
202012136462	GAMELEIRA DE GOIAS	GL12389474	DAIA S2	24/12/2020 04:50	24/12/2020 11:53	24/12/2020 04:50	24/12/2020 11:53	7,05	32	225,58	CHI
202012136462	ANAPOLIS	GL12389474	DAIA S2	24/12/2020 04:50	24/12/2020 11:53	24/12/2020 04:50	24/12/2020 11:53	7,05	4	28,20	CHI
202012135926	BONOPOLIS	BX12202542	SAO MIGUEL DO ARAGUAIA	24/12/2020 04:51	24/12/2020 11:18	24/12/2020 04:51	24/12/2020 11:18	6,44	53	341,10	CHI
202012135926	PORANGATU	BX12202542	SAO MIGUEL DO ARAGUAIA	24/12/2020 04:51	24/12/2020 11:18	24/12/2020 04:51	24/12/2020 11:18	6,44	1	6,44	CHI
202012136120	QUIRINOPOLIS	PC12000130	QUIRINOPOLIS	24/12/2020 04:51	24/12/2020 07:37	24/12/2020 04:51	24/12/2020 07:37	2,77	8	22,13	CHI
202012136120	PARANAIGUARA	PC12000130	QUIRINOPOLIS	24/12/2020 04:51	24/12/2020 07:37	24/12/2020 04:51	24/12/2020 07:37	2,77	8	22,13	CHI
202012136249	BONOPOLIS	BX12168214	SAO MIGUEL DO ARAGUAIA	24/12/2020 04:51	24/12/2020 09:37	24/12/2020 04:51	24/12/2020 09:37	4,76	124	589,72	CHI
202012136432	BONOPOLIS	BX21333257	SAO MIGUEL DO ARAGUAIA	24/12/2020 04:51	24/12/2020 12:59	24/12/2020 04:51	24/12/2020 12:59	8,12	1	8,12	CHI
202012137658	MATRINCHA	MP12041292	MOZARLANDIA	24/12/2020 04:51	24/12/2020 12:44	24/12/2020 04:51	24/12/2020 12:44	7,88	1	7,88	CHI
202012137658	ARUANA	MP12041292	MOZARLANDIA	24/12/2020 04:51	24/12/2020 12:44	24/12/2020 04:51	24/12/2020 12:44	7,88	3	23,65	CHI
202012136150	CALDAZINHA	BV12070811	CEPAIGO S2	24/12/2020 04:52	24/12/2020 12:51	24/12/2020 04:52	24/12/2020 12:51	7,98	16	127,68	CHI
202012136293	SAO MIGUEL DO ARAGUAIA	SM12228636	SAO MIGUEL DO ARAGUAIA	24/12/2020 04:54	24/12/2020 08:18	24/12/2020 04:54	24/12/2020 08:18	3,40	58	197,15	CHI
202012136609	GUAPO	GA12011344	GUAPO S2	24/12/2020 04:54	24/12/2020 08:19	24/12/2020 04:54	24/12/2020 08:19	3,40	56	190,62	CHI
202012136609	CAMPESTRE DE GOIAS	GA12011344	GUAPO S2	24/12/2020 04:54	24/12/2020 08:19	24/12/2020 04:54	24/12/2020 08:19	3,40	13	44,25	CHI
202012135822	PALMEIRAS DE GOIAS	PL12016686	PALMEIRAS	24/12/2020 04:57	24/12/2020 10:01	24/12/2020 04:57	24/12/2020 10:01	5,06	11	55,71	CHI
202012136082	ALTO HORIZONTE	GG12150758	SANTA TEREZINHA	24/12/2020 04:57	24/12/2020 08:25	24/12/2020 04:57	24/12/2020 08:25	3,45	10	34,50	CHI
202012136357	AMARALINA	MU12391672	MARA ROSA	24/12/2020 04:57	24/12/2020 08:02	24/12/2020 04:57	24/12/2020 08:02	3,07	100	306,89	CHI
202012136357	MUTUNOPOLIS	MU12391672	MARA ROSA	24/12/2020 04:57	24/12/2020 08:02	24/12/2020 04:57	24/12/2020 08:02	3,07	7	21,48	CHI

202012136460	DOVERLANDIA	DV12207932	CAIAPONIA	24/12/2020 04:57	24/12/2020 13:13	24/12/2020 04:57	24/12/2020 13:13	8,26	6	49,55	CHI
202012135946	IACIARA	IA12257594	IACIARA S2	24/12/2020 05:00	24/12/2020 07:16	24/12/2020 05:00	24/12/2020 07:16	2,27	5	11,33	CHI
202012135947	PIRANHAS	PH12038595	PIRANHAS	24/12/2020 05:00	24/12/2020 07:24	24/12/2020 05:00	24/12/2020 07:24	2,39	5	11,94	CHI
202012136294	DOVERLANDIA	MY12234375	PARQUE DAS EMAS	24/12/2020 05:00	24/12/2020 10:24	24/12/2020 05:00	24/12/2020 10:24	5,39	4	21,55	CHI
202012136294	MINEIROS	MY12234375	PARQUE DAS EMAS	24/12/2020 05:00	24/12/2020 10:24	24/12/2020 05:00	24/12/2020 10:24	5,39	8	43,10	CHI
202012136294	CAIAPONIA	MY12234375	PARQUE DAS EMAS	24/12/2020 05:00	24/12/2020 10:24	24/12/2020 05:00	24/12/2020 10:24	5,39	1	5,39	CHI
202012136142	ITAPURANGA	IK12220545	ITAPURANGA	24/12/2020 05:02	24/12/2020 07:15	24/12/2020 05:02	24/12/2020 07:15	2,20	53	116,75	CHI
202012135984	JANDAIA	PP12312499RE	PALMEIRAS	24/12/2020 05:03	24/12/2020 08:03	24/12/2020 05:03	24/12/2020 08:03	3,00	29	86,90	CHI
202012135984	PALMINOPOLIS	PP12312499RE	PALMEIRAS	24/12/2020 05:03	24/12/2020 08:03	24/12/2020 05:03	24/12/2020 08:03	3,00	70	209,77	CHI
202012136466	IPAMERI	IP12017029	IPAMERI	24/12/2020 05:05	24/12/2020 10:15	24/12/2020 05:05	24/12/2020 10:15	5,15	15	77,28	CHI
202012136113	JUSSARA	JR12124817	BRITANIA	24/12/2020 05:06	24/12/2020 12:15	24/12/2020 05:06	24/12/2020 12:15	7,14	11	78,57	CHI
202012135962	BONOPOLIS	BX12263014	SAO MIGUEL DO ARAGUAIA	24/12/2020 05:09	24/12/2020 10:05	24/12/2020 05:09	24/12/2020 10:05	4,92	4	19,67	CHI
202012136108	MUTUNOPOLIS	MU12076698	MARA ROSA	24/12/2020 05:09	24/12/2020 08:26	24/12/2020 05:09	24/12/2020 08:26	3,27	31	101,39	CHI
202012136108	ESTRELA DO NORTE	MU12076698	MARA ROSA	24/12/2020 05:09	24/12/2020 08:26	24/12/2020 05:09	24/12/2020 08:26	3,27	1	3,27	CHI
202012135967	IPAMERI	IP12027061	URUTAI	24/12/2020 05:13	24/12/2020 12:37	24/12/2020 05:13	24/12/2020 12:37	7,39	27	199,64	CHI
202012135973	GOIAS	GS12087523RE	GOIAS	24/12/2020 05:16	24/12/2020 07:25	24/12/2020 05:16	24/12/2020 07:25	2,14	68	145,26	CHI
202012135974	CAMPINACU	UC12197189	PORANGATU	24/12/2020 05:17	24/12/2020 07:51	24/12/2020 05:17	24/12/2020 07:51	2,56	31	79,47	CHI
202012136870	MUTUNOPOLIS	MU12141105	MARA ROSA	24/12/2020 05:19	24/12/2020 14:07	24/12/2020 05:19	24/12/2020 14:07	8,79	25	219,87	CHI
202012136115	NOVA CRIXAS	MZ12055676	MOZARLANDIA	24/12/2020 05:20	24/12/2020 21:05	24/12/2020 05:20	24/12/2020 21:05	15,74	10	157,45	CHI
202012136384	MINEIROS	MY12209755	PARQUE DAS EMAS	24/12/2020 05:21	24/12/2020 21:36	24/12/2020 05:21	24/12/2020 21:36	16,24	17	276,06	CHI
202012135981	MORRINHOS	MR12092130	MORRINHOS	24/12/2020 05:22	24/12/2020 08:44	24/12/2020 05:22	24/12/2020 08:44	3,36	13	43,74	CHI
202012136001	DOVERLANDIA	DV12138406	CAIAPONIA	24/12/2020 05:22	24/12/2020 07:26	24/12/2020 05:22	24/12/2020 07:26	2,06	12	24,69	CHI
202012136026	PILAR DE GOIAS	GG12318452	URUACU	24/12/2020 05:27	24/12/2020 07:46	24/12/2020 05:27	24/12/2020 07:46	2,31	87	200,99	CHI
202012136026	GUARINOS	GG12318452	URUACU	24/12/2020 05:27	24/12/2020 07:46	24/12/2020 05:27	24/12/2020 07:46	2,31	1	2,31	CHI
202012136026	SANTA TEREZINHA DE GOIAS	GG12318452	URUACU	24/12/2020 05:27	24/12/2020 07:46	24/12/2020 05:27	24/12/2020 07:46	2,31	4	9,24	CHI
202012137065	ARENOPOLIS	AY12259346	IPORA	24/12/2020 05:27	25/12/2020 10:10	24/12/2020 05:27	25/12/2020 10:10	28,71	22	631,54	CHI
202012135092	CAMPINACU	5700008419	PORANGATU	24/12/2020 05:28	24/12/2020 13:13	24/12/2020 05:28	24/12/2020 13:13	7,75	1	7,75	CHI
202012135995	APORE	IJ12202625RE	ITAJA S2	24/12/2020 05:28	24/12/2020 07:44	24/12/2020 05:28	24/12/2020 07:44	2,25	4	9,01	CHI
202012135995	ITAJA	IJ12202625RE	ITAJA S2	24/12/2020 05:28	24/12/2020 07:44	24/12/2020 05:28	24/12/2020 07:44	2,25	15	33,79	CHI
202012135999	LUZIANIA	LZ12261608	VIANOPOLIS	24/12/2020 05:30	24/12/2020 08:21	24/12/2020 05:30	24/12/2020 08:21	2,84	71	201,66	CHI
202012136045	FAINA	FC12158864	GOIAS	24/12/2020 05:30	24/12/2020 13:52	24/12/2020 05:30	24/12/2020 13:52	8,36	11	91,94	CHI
202012136004	PIRES DO RIO	PR12000096RE	PIRES DO RIO S1	24/12/2020 05:34	24/12/2020 08:15	24/12/2020 05:34	24/12/2020 08:15	2,67	21	56,05	CHI
202012136004	PALMELO	PR12000096RE	PIRES DO RIO S1	24/12/2020 05:34	24/12/2020 08:15	24/12/2020 05:34	24/12/2020 08:15	2,67	5	13,34	CHI
202012136230	CACU	CC12170574	CACHOEIRA ALTA	24/12/2020 05:34	24/12/2020 10:24	24/12/2020 05:34	24/12/2020 10:24	4,82	88	424,09	CHI
202012136230	APARECIDA DO RIO DOCE	CC12170574	CACHOEIRA ALTA	24/12/2020 05:34	24/12/2020 10:24	24/12/2020 05:34	24/12/2020 10:24	4,82	10	48,19	CHI
202012136006	NIQUELANDIA	NQ12181068RE	URUACU	24/12/2020 05:35	24/12/2020 08:08	24/12/2020 05:35	24/12/2020 08:08	2,53	108	273,66	CHI
202012136007	PARANAIGUARA	PC12000129	CACHOEIRA ALTA	24/12/2020 05:36	24/12/2020 09:01	24/12/2020 05:36	24/12/2020 09:01	3,41	24	81,80	CHI
202012137235	DAVINOPOLIS	IO12394028	CATALAO S1	24/12/2020 05:36	24/12/2020 09:36	24/12/2020 05:36	24/12/2020 09:36	3,99	6	23,91	CHI
202012137235	CATALAO	IO12394028	CATALAO S1	24/12/2020 05:36	24/12/2020 09:36	24/12/2020 05:36	24/12/2020 09:36	3,99	15	59,78	CHI
202012136055	ARAGUAPAZ	AZ12404546	MOZARLANDIA	24/12/2020 05:37	24/12/2020 08:32	24/12/2020 05:37	24/12/2020 08:32	2,92	7	20,42	CHI
202012137753	INACIOLANDIA	ID12271587LD	CACHOEIRA DOURADA	24/12/2020 05:39	24/12/2020 18:09	24/12/2020 05:39	24/12/2020 18:09	12,48	11	137,32	CHI
202012136020	MORRINHOS	MR12254399	MORRINHOS	24/12/2020 05:43	24/12/2020 11:39	24/12/2020 05:43	24/12/2020 11:39	5,93	3	17,80	CHI
202012136023	PANAMA	PX12057616	GOIATUBA S1	24/12/2020 05:44	24/12/2020 08:07	24/12/2020 05:44	24/12/2020 08:07	2,38	47	111,66	CHI
202012136764	CACHOEIRA DE GOIAS	AI12126017	FIRMINOPOLIS S2	24/12/2020 05:44	24/12/2020 10:25	24/12/2020 05:44	24/12/2020 10:25	4,68	4	18,72	CHI
202012136764	AURILANDIA	AI12126017	FIRMINOPOLIS S2	24/12/2020 05:44	24/12/2020 10:25	24/12/2020 05:44	24/12/2020 10:25	4,68	5	23,39	CHI
202012136025	PIRACANJUBA	PJ12039733	PIRACANJUBA	24/12/2020 05:45	24/12/2020 07:22	24/12/2020 05:45	24/12/2020 07:22	1,62	28	45,25	CHI
202012136224	MOSSAMEDES	MD12299584	ITABERAI S2	24/12/2020 05:45	24/12/2020 11:41	24/12/2020 05:45	24/12/2020 11:41	5,93	14	83,07	CHI
202012136440	CRISTALINA	IP12165527	CRISTALINA S1	24/12/2020 05:45	24/12/2020 07:48	24/12/2020 05:45	24/12/2020 07:48	2,04	15	30,67	CHI
202012136030	IPORA	IR12289241	IPORA	24/12/2020 05:46	24/12/2020 08:43	24/12/2020 05:46	24/12/2020 08:43	2,95	5	14,74	CHI
202012136031	CAMPINACU	IH12360453	MINACU	24/12/2020 05:46	24/12/2020 09:51	24/12/2020 05:46	24/12/2020 09:51	4,08	5	20,40	CHI
202012136031	MINACU	IH12360453	MINACU	24/12/2020 05:46	24/12/2020 09:51	24/12/2020 05:46	24/12/2020 09:51	4,08	80	326,38	CHI

202012136033	PARAUNA	PU12301174	ACREUNA	24/12/2020 05:47	24/12/2020 08:18	24/12/2020 05:47	24/12/2020 08:18	2,51	13	32,69	CHI
202012136126	FORMOSA	FA12402620	ITIQUEIRA	24/12/2020 05:47	24/12/2020 12:34	24/12/2020 05:47	24/12/2020 12:34	6,78	34	230,60	CHI
202012136311	SANTA FE DE GOIAS	RN12378892	BRITANIA	24/12/2020 05:47	24/12/2020 12:06	24/12/2020 05:47	24/12/2020 12:06	6,31	19	119,80	CHI
202012136882	ITAPIRAPUA	IU12089742	MATRINCHA	24/12/2020 05:49	24/12/2020 09:49	24/12/2020 05:49	24/12/2020 09:49	3,99	5	19,93	CHI
202012137505	CHAPADAO DO CEU	DJ12378153LD	CHAPADAO DO CEU	24/12/2020 05:49	24/12/2020 18:58	24/12/2020 05:49	24/12/2020 18:58	13,15	2	26,29	CHI
202012135460	PEROLANDIA	JT12070005LD	JATAI S1	24/12/2020 05:51	24/12/2020 09:59	24/12/2020 05:51	24/12/2020 09:59	4,12	9	37,05	CHI
202012135460	JATAI	JT12070005LD	JATAI S1	24/12/2020 05:51	24/12/2020 09:59	24/12/2020 05:51	24/12/2020 09:59	4,12	109	448,78	CHI
202012136705	NIQUELANDIA	NQ12262921	BARRO ALTO	24/12/2020 05:51	24/12/2020 17:29	24/12/2020 05:51	24/12/2020 17:29	11,63	6	69,76	CHI
202012138109	JATAI	6607019	JATAI S1	24/12/2020 05:53	24/12/2020 19:53	24/12/2020 05:53	24/12/2020 19:53	13,99	13	181,82	CHI
202012138109	SERRANOPOLIS	6607019	JATAI S1	24/12/2020 05:53	24/12/2020 19:53	24/12/2020 05:53	24/12/2020 19:53	13,99	126	1762,22	CHI
202012136059	GOIANIA	GN11274972	CARAJAS S2	24/12/2020 05:54	24/12/2020 08:16	24/12/2020 05:54	24/12/2020 08:16	2,36	58	137,03	CHI
202012136580	PORANGATU	PO12192252	PORANGATU	24/12/2020 05:54	24/12/2020 08:36	24/12/2020 05:54	24/12/2020 08:36	2,69	25	67,37	CHI
202012136109	CASTELANDIA	ML12303570	RIO DOS BOIS	24/12/2020 05:55	24/12/2020 07:24	24/12/2020 05:55	24/12/2020 07:24	1,47	4	5,87	CHI
202012136109	MAURILANDIA	ML12303570	RIO DOS BOIS	24/12/2020 05:55	24/12/2020 07:24	24/12/2020 05:55	24/12/2020 07:24	1,47	2	2,93	CHI
202012136437	PILAR DE GOIAS	GG12181616	SANTA TEREZINHA	24/12/2020 05:55	24/12/2020 08:32	24/12/2020 05:55	24/12/2020 08:32	2,61	3	7,82	CHI
202012136437	SANTA TEREZINHA DE GOIAS	GG12181616	SANTA TEREZINHA	24/12/2020 05:55	24/12/2020 08:32	24/12/2020 05:55	24/12/2020 08:32	2,61	6	15,64	CHI
202012136514	RUBIATABA	RB12060965	RUBIATABA	24/12/2020 05:55	24/12/2020 14:47	24/12/2020 05:55	24/12/2020 14:47	8,85	56	495,77	CHI
202012136084	ITABERAI	IX12321505	INHUMAS S1	24/12/2020 05:59	24/12/2020 13:43	24/12/2020 05:59	24/12/2020 13:43	7,72	1	7,72	CHI
202012136084	ITAUCU	IX12321505	INHUMAS S1	24/12/2020 05:59	24/12/2020 13:43	24/12/2020 05:59	24/12/2020 13:43	7,72	20	154,37	CHI
202012136099	PROFESSOR JAMIL SAFADY	CQ12077788	PONTALINA	24/12/2020 06:01	24/12/2020 07:30	24/12/2020 06:01	24/12/2020 07:30	1,47	6	8,82	CHI
202012136099	CROMINIA	CQ12077788	PONTALINA	24/12/2020 06:01	24/12/2020 07:30	24/12/2020 06:01	24/12/2020 07:30	1,47	11	16,18	CHI
202012136098	CALDAS NOVAS	760327750	CALDAS NOVAS S2	24/12/2020 06:02	24/12/2020 17:12	24/12/2020 06:02	24/12/2020 17:12	11,16	1	11,16	CHI
202012136102	FLORES DE GOIAS	FB12320627	FLORES DE GOIAS	24/12/2020 06:02	24/12/2020 13:12	24/12/2020 06:02	24/12/2020 13:12	7,15	28	200,23	CHI
202012136117	SAO LUIZ DO NORTE	GE12352313	GOIANESIA S1	24/12/2020 06:04	24/12/2020 16:32	24/12/2020 06:04	24/12/2020 16:32	10,46	21	219,60	CHI
202012136117	GOIANESIA	GE12352313	GOIANESIA S1	24/12/2020 06:04	24/12/2020 16:32	24/12/2020 06:04	24/12/2020 16:32	10,46	24	250,97	CHI
202012136136	ANICUNS	AC12304663	FIRMINOPOLIS S2	24/12/2020 06:04	24/12/2020 11:18	24/12/2020 06:04	24/12/2020 11:18	5,22	11	57,43	CHI
202012136458	GOIANESIA	GE12322006	GOIANESIA S1	24/12/2020 06:04	24/12/2020 09:41	24/12/2020 06:04	24/12/2020 09:41	3,61	7	25,26	CHI
202012136458	SANTA RITA DO NOVO DESTINO	GE12322006	GOIANESIA S1	24/12/2020 06:04	24/12/2020 09:41	24/12/2020 06:04	24/12/2020 09:41	3,61	8	28,87	CHI
202012136583	SILVANIA	AN12285354	ANAPOLIS UNIVERSITARIO S2	24/12/2020 06:04	24/12/2020 11:41	24/12/2020 06:04	24/12/2020 11:41	5,61	20	112,20	CHI
202012136583	GAMELEIRA DE GOIAS	AN12285354	ANAPOLIS UNIVERSITARIO S2	24/12/2020 06:04	24/12/2020 11:41	24/12/2020 06:04	24/12/2020 11:41	5,61	8	44,88	CHI
202012136194	MUTUNOPOLIS	MU12354547	MARA ROSA	24/12/2020 06:06	24/12/2020 11:54	24/12/2020 06:06	24/12/2020 11:54	5,81	12	69,73	CHI
202012136682	FIRMINOPOLIS	FR12000056	FIRMINOPOLIS S1	24/12/2020 06:06	24/12/2020 08:40	24/12/2020 06:06	24/12/2020 08:40	2,56	1	2,56	CHI
202012136682	SAO JOAO DA PARAUNA	FR12000056	PARAUNA	24/12/2020 06:06	24/12/2020 08:40	24/12/2020 06:06	24/12/2020 08:40	2,56	45	115,19	CHI
202012136682	SAO JOAO DA PARAUNA	FR12000056	FIRMINOPOLIS S1	24/12/2020 06:06	24/12/2020 08:40	24/12/2020 06:06	24/12/2020 08:40	2,56	18	46,07	CHI
202012136682	FIRMINOPOLIS	FR12000056	FIRMINOPOLIS S1	24/12/2020 06:06	24/12/2020 08:40	24/12/2020 06:06	24/12/2020 08:40	2,56	29	74,23	CHI
202012136423	MARA ROSA	MQ12263046	MARA ROSA	24/12/2020 06:07	24/12/2020 11:51	24/12/2020 06:07	24/12/2020 11:51	5,72	7	40,03	CHI
202012136141	CALDAS NOVAS	CN12100082	VILA CORUMBA	24/12/2020 06:09	24/12/2020 09:27	24/12/2020 06:09	24/12/2020 09:27	3,30	1	3,30	CHI
202012136208	MONTES CLAROS DE GOIAS	JR12022269RE	BRITANIA	24/12/2020 06:09	24/12/2020 09:30	24/12/2020 06:09	24/12/2020 09:30	3,37	270	908,85	CHI
202012136208	JUSSARA	JR12022269RE	BRITANIA	24/12/2020 06:09	24/12/2020 09:30	24/12/2020 06:09	24/12/2020 09:30	3,37	30	100,98	CHI
202012136265	CAMPOS VERDES	VD12257347	SANTA TEREZINHA	24/12/2020 06:09	24/12/2020 09:06	24/12/2020 06:09	24/12/2020 09:06	2,94	3	8,82	CHI
202012136147	IPAMERI	IP12099279	PIRES DO RIO S2	24/12/2020 06:11	24/12/2020 09:34	24/12/2020 06:11	24/12/2020 09:34	3,39	1	3,39	CHI
202012136382	FAINA	FC12084192	GOIAS	24/12/2020 06:11	24/12/2020 11:37	24/12/2020 06:11	24/12/2020 11:37	5,42	4	21,68	CHI
202012136157	PANAMA	PX12008278	GOIATUBA S1	24/12/2020 06:12	24/12/2020 09:42	24/12/2020 06:12	24/12/2020 09:42	3,50	7	24,49	CHI
202012136157	GOIATUBA	PX12008278	GOIATUBA S1	24/12/2020 06:12	24/12/2020 09:42	24/12/2020 06:12	24/12/2020 09:42	3,50	9	31,49	CHI
202012136159	LUZIANIA	LZ12149936	MARAJOARA	24/12/2020 06:12	24/12/2020 10:21	24/12/2020 06:12	24/12/2020 10:21	4,16	13	54,10	CHI
202012136160	SERRANOPOLIS	DJ12164269	CHAPADAO DO CEU	24/12/2020 06:12	24/12/2020 20:36	24/12/2020 06:12	24/12/2020 20:36	14,40	5	71,98	CHI
202012136166	ARAGARCAS	BM12204862	IPORA	24/12/2020 06:13	24/12/2020 10:38	24/12/2020 06:13	24/12/2020 10:38	4,41	2	8,83	CHI
202012136171	MINEIROS	MY12296303	PARQUE DAS EMAS	24/12/2020 06:13	24/12/2020 18:43	24/12/2020 06:13	24/12/2020 18:43	12,50	4	49,99	CHI
202012136174	PIRANHAS	PH12092232	BOM JARDIM	24/12/2020 06:13	24/12/2020 15:28	24/12/2020 06:13	24/12/2020 15:28	9,24	7	64,65	CHI
202012136879	PARAUNA	PU12295868	ACREUNA	24/12/2020 06:13	24/12/2020 16:20	24/12/2020 06:13	24/12/2020 16:20	10,11	10	101,06	CHI
202012136232	PEROLANDIA	DP12103843LD	JATAI S1	24/12/2020 06:14	24/12/2020 08:50	24/12/2020 06:14	24/12/2020 08:50	2,59	13	33,62	CHI

202012136355	PORANGATU	PO12027986	PORANGATU	24/12/2020 06:14	24/12/2020 22:13	24/12/2020 06:14	24/12/2020 22:13	15,98	10	159,83	CHI
202012136826	CAMPOS VERDES	VD12201662	SANTA TEREZINHA	24/12/2020 06:14	24/12/2020 10:44	24/12/2020 06:14	24/12/2020 10:44	4,49	5	22,43	CHI
202012136204	BONOPOLIS	BX12316276	SAO MIGUEL DO ARAGUAIA	24/12/2020 06:15	24/12/2020 08:13	24/12/2020 06:15	24/12/2020 08:13	1,96	4	7,83	CHI
202012136312	SAO LUIS DE MONTES BELOS	SL12383600	SAO LUIZ DOS MONTES BELOS	24/12/2020 06:15	24/12/2020 10:23	24/12/2020 06:15	24/12/2020 10:23	4,12	9	37,11	CHI
202012136396	BOM JARDIM DE GOIAS	BM12349615	BOM JARDIM	24/12/2020 06:16	24/12/2020 10:38	24/12/2020 06:16	24/12/2020 10:38	4,36	16	69,73	CHI
202012136199	MINEIROS	MY12324396RE	PARQUE DAS EMAS	24/12/2020 06:17	24/12/2020 17:37	24/12/2020 06:17	24/12/2020 17:37	11,33	21	237,89	CHI
202012136774	CACU	CC21097092	SAO MIGUEL DO ARAGUAIA	24/12/2020 06:18	24/12/2020 08:54	24/12/2020 06:18	24/12/2020 08:54	2,59	1	2,59	CHI
202012136210	ORIZONA	OZ12186216	PIRES DO RIO S2	24/12/2020 06:19	24/12/2020 09:11	24/12/2020 06:19	24/12/2020 09:11	2,86	11	31,45	CHI
202012136454	MINEIROS	MY12349169	PARQUE DAS EMAS	24/12/2020 06:19	24/12/2020 18:15	24/12/2020 06:19	24/12/2020 18:15	11,92	3	35,77	CHI
202012136988	SAO FRANCISCO DE GOIAS	SF12032711	SAO FRANCISCO DE GOIAS	24/12/2020 06:19	24/12/2020 16:01	24/12/2020 06:19	24/12/2020 10:59	4,68	241	1126,68	CHI
202012136988	SAO FRANCISCO DE GOIAS	SF11107970	SAO FRANCISCO DE GOIAS	24/12/2020 06:19	24/12/2020 16:01	24/12/2020 06:19	24/12/2020 16:01	9,70	76	736,90	CHI
202012137111	BARRO ALTO	BA12068485	BARRO ALTO	24/12/2020 06:19	24/12/2020 10:49	24/12/2020 06:19	24/12/2020 10:49	4,49	1	4,49	CHI
202012137111	SANTA RITA DO NOVO DESTINO	BA12068485	BARRO ALTO	24/12/2020 06:19	24/12/2020 10:49	24/12/2020 06:19	24/12/2020 10:49	4,49	31	139,23	CHI
202012138168	IACIARA	IA12242614	IACIARA S1	24/12/2020 06:19	24/12/2020 13:21	24/12/2020 06:19	24/12/2020 13:21	7,02	2	14,05	CHI
202012136240	FAINA	FC12396534	ITAPURANGA	24/12/2020 06:23	24/12/2020 15:00	24/12/2020 06:23	24/12/2020 15:00	8,61	7	60,29	CHI
202012136540	GOIANESIA	GE12384172	GOIANESIA S2	24/12/2020 06:23	24/12/2020 21:11	24/12/2020 06:23	24/12/2020 21:11	14,80	5	73,99	CHI
202012137579	JATAI	JT12080483	JATAI S1	24/12/2020 06:23	24/12/2020 11:27	24/12/2020 06:23	24/12/2020 11:27	5,05	10	50,51	CHI
202012136255	QUIRINOPOLIS	QI32050379	QUIRINOPOLIS	24/12/2020 06:24	24/12/2020 08:15	24/12/2020 06:24	24/12/2020 08:15	1,84	9	16,52	CHI
202012136516	ARENOPOLIS	AY12390169	ARENOPOLIS	24/12/2020 06:25	24/12/2020 09:40	24/12/2020 06:25	24/12/2020 09:40	3,24	22	71,31	CHI
202012136516	DIORAMA	AY12390169	ARENOPOLIS	24/12/2020 06:25	24/12/2020 09:40	24/12/2020 06:25	24/12/2020 09:40	3,24	3	9,72	CHI
202012136572	GUAPO	AO12095512	GUAPO S2	24/12/2020 06:25	24/12/2020 09:28	24/12/2020 06:25	24/12/2020 09:28	3,05	10	30,49	CHI
202012136572	ARAGOIANIA	AO12095512	GUAPO S2	24/12/2020 06:25	24/12/2020 09:28	24/12/2020 06:25	24/12/2020 09:28	3,05	19	57,94	CHI
202012136262	CORUMBA DE GOIAS	CB12381244	CORUMBA	24/12/2020 06:26	24/12/2020 14:22	24/12/2020 06:26	24/12/2020 14:22	7,93	1	7,93	CHI
202012136263	SERRANOPOLIS	IM12058692	CACHOEIRA ALTA	24/12/2020 06:26	24/12/2020 09:56	24/12/2020 06:26	24/12/2020 09:56	3,50	43	150,37	CHI
202012136263	ITARUMA	IM12058692	CACHOEIRA ALTA	24/12/2020 06:26	24/12/2020 09:56	24/12/2020 06:26	24/12/2020 09:56	3,50	7	24,48	CHI
202012136266	SANTA TEREZA DE GOIAS	TB12262770	PORANGATU	24/12/2020 06:26	24/12/2020 10:09	24/12/2020 06:26	24/12/2020 10:09	3,71	5	18,53	CHI
202012136266	TROMBAS	TB12262770	PORANGATU	24/12/2020 06:26	24/12/2020 10:09	24/12/2020 06:26	24/12/2020 10:09	3,71	13	48,19	CHI
202012136266	PORANGATU	TB12262770	PORANGATU	24/12/2020 06:26	24/12/2020 10:09	24/12/2020 06:26	24/12/2020 10:09	3,71	1	3,71	CHI
202012136267	MINEIROS	MY12303343RE	PARQUE DAS EMAS	24/12/2020 06:26	24/12/2020 19:00	24/12/2020 06:26	24/12/2020 19:00	12,55	32	401,73	CHI
202012136272	PIRES DO RIO	PR12056194	PIRES DO RIO S1	24/12/2020 06:27	24/12/2020 08:12	24/12/2020 06:27	24/12/2020 08:12	1,75	452	791,38	CHI
202012136313	JUSSARA	RN12078427	BRITANIA	24/12/2020 06:28	24/12/2020 10:55	24/12/2020 06:28	24/12/2020 10:55	4,44	3	13,31	CHI
202012136313	SANTA FE DE GOIAS	RN12078427	BRITANIA	24/12/2020 06:28	24/12/2020 10:55	24/12/2020 06:28	24/12/2020 10:55	4,44	2	8,87	CHI
202012137012	SERRANOPOLIS	SX12153265	JATAI S1	24/12/2020 06:28	24/12/2020 10:55	24/12/2020 06:28	24/12/2020 10:55	4,43	4	17,74	CHI
202012137012	ITARUMA	SX12153265	JATAI S1	24/12/2020 06:28	24/12/2020 10:55	24/12/2020 06:28	24/12/2020 10:55	4,43	1	4,43	CHI
202012137012	APORE	SX12153265	JATAI S1	24/12/2020 06:28	24/12/2020 10:55	24/12/2020 06:28	24/12/2020 10:55	4,43	7	31,04	CHI
202012136340	ITAPIRAPUA	IU12008889	MATRINCHA	24/12/2020 06:29	24/12/2020 13:44	24/12/2020 06:29	24/12/2020 13:44	7,25	9	65,21	CHI
202012137189	GAMELEIRA DE GOIAS	SV12125444	DAIA S2	24/12/2020 06:29	24/12/2020 11:01	24/12/2020 06:29	24/12/2020 11:01	4,52	29	131,03	CHI
202012137266	SAO MIGUEL DO ARAGUAIA	SM12000050	SAO MIGUEL DO ARAGUAIA	24/12/2020 06:30	24/12/2020 12:22	24/12/2020 06:30	24/12/2020 12:22	5,86	29	170,05	CHI
202012137260	CRISTALINA	KR12412022	CRISTALINA S2	24/12/2020 06:32	24/12/2020 11:09	24/12/2020 06:32	24/12/2020 11:09	4,61	4	18,45	CHI
202012136316	PIRACANJUBA	PJ12000082	PIRACANJUBA	24/12/2020 06:34	24/12/2020 09:13	24/12/2020 06:34	24/12/2020 09:13	2,64	4	10,54	CHI
202012136318	APORE	AE11000013	ITAJA S1	24/12/2020 06:35	24/12/2020 23:09	24/12/2020 06:35	24/12/2020 23:09	16,56	52	861,25	CHI
202012136320	CATALAO	CT12358318	CATALAO S2	24/12/2020 06:35	24/12/2020 11:48	24/12/2020 06:35	24/12/2020 11:48	5,21	6	31,25	CHI
202012136439	FAINA	FC12038664	GOIAS	24/12/2020 06:35	24/12/2020 13:42	24/12/2020 06:35	24/12/2020 13:42	7,10	10	71,05	CHI
202012137686	ARENOPOLIS	DI12188377	ARENOPOLIS	24/12/2020 06:35	24/12/2020 11:30	24/12/2020 06:35	24/12/2020 11:30	4,92	1	4,92	CHI
202012137686	DIORAMA	DI12188377	ARENOPOLIS	24/12/2020 06:35	24/12/2020 11:30	24/12/2020 06:35	24/12/2020 11:30	4,92	12	58,99	CHI
202012136331	PEROLANDIA	DP12254610	JATAI S1	24/12/2020 06:37	24/12/2020 16:16	24/12/2020 06:37	24/12/2020 16:16	9,65	2	19,29	CHI
202012136339	LUZIANIA	LZ12000226	RIO VERMELHO	24/12/2020 06:38	24/12/2020 10:21	24/12/2020 06:38	24/12/2020 10:21	3,72	3	11,15	CHI
202012136344	FORMOSA	FA12376643	ITUIQUIRA	24/12/2020 06:38	24/12/2020 10:29	24/12/2020 06:38	24/12/2020 10:29	3,84	101	387,42	CHI
202012136898	MARA ROSA	MQ12380741	SANTA TEREZINHA	24/12/2020 06:38	24/12/2020 11:03	24/12/2020 06:38	24/12/2020 11:03	4,41	13	57,29	CHI
202012136620	CALDAS NOVAS	MR12059843	MORRINHOS	24/12/2020 06:39	24/12/2020 08:20	24/12/2020 06:39	24/12/2020 08:20	1,67	7	11,72	CHI
202012136620	PIRACANJUBA	MR12059843	MORRINHOS	24/12/2020 06:39	24/12/2020 08:20	24/12/2020 06:39	24/12/2020 08:20	1,67	4	6,70	CHI

202012136620	MORRINHOS	MR12059843	MORRINHOS	24/12/2020 06:39	24/12/2020 08:20	24/12/2020 06:39	24/12/2020 08:20	1,67	12	20,09	CHI
202012137514	PEROLANDIA	DP12182220	JATAI S1	24/12/2020 06:39	24/12/2020 15:35	24/12/2020 06:39	24/12/2020 15:35	8,92	7	62,43	CHI
202012135803	ITARUMA	IM12107433	CACHOEIRA ALTA	24/12/2020 06:41	24/12/2020 09:41	24/12/2020 06:41	24/12/2020 09:41	2,99	7	20,96	CHI
202012135803	SERRANOPOLIS	IM12107433	CACHOEIRA ALTA	24/12/2020 06:41	24/12/2020 09:41	24/12/2020 06:41	24/12/2020 09:41	2,99	8	23,95	CHI
202012136362	LUZIANIA	LZ12376186	RIO VERMELHO	24/12/2020 06:41	24/12/2020 08:42	24/12/2020 06:41	24/12/2020 08:42	2,02	69	139,13	CHI
202012136368	SAO DOMINGOS	SD12134715LD	SAO DOMINGOS	24/12/2020 06:42	24/12/2020 09:37	24/12/2020 06:42	24/12/2020 09:37	2,91	87	253,24	CHI
202012136368	GUARANI DE GOIAS	SD12134715LD	SAO DOMINGOS	24/12/2020 06:42	24/12/2020 09:37	24/12/2020 06:42	24/12/2020 09:37	2,91	3	8,73	CHI
202012136374	MARA ROSA	MQ11292663	MARA ROSA	24/12/2020 06:42	25/12/2020 12:07	24/12/2020 06:42	25/12/2020 12:07	29,40	72	2117,08	CHI
202012136408	COLINAS DO SUL	TI12271095	MINACU	24/12/2020 06:42	24/12/2020 11:00	24/12/2020 06:42	24/12/2020 11:00	4,29	23	98,78	CHI
202012136982	CACHOEIRA DE GOIAS	CG12206059	FIRMINOPOLIS S2	24/12/2020 06:43	24/12/2020 10:34	24/12/2020 06:43	24/12/2020 10:34	3,84	25	96,01	CHI
202012136386	SILVANIA	SV12382755	VIANOPOLIS	24/12/2020 06:44	24/12/2020 14:22	24/12/2020 06:44	24/12/2020 14:22	7,62	1	7,62	CHI
202012136390	RIO VERDE	6620345	ACREUNA	24/12/2020 06:45	24/12/2020 11:21	24/12/2020 10:10	24/12/2020 11:10	0,98	4	3,94	CHI
202012136390	RIO VERDE	RV12046332	ACREUNA	24/12/2020 06:45	24/12/2020 11:21	24/12/2020 06:45	24/12/2020 11:21	4,61	4	18,43	CHI
202012136390	SANTO ANTONIO DA BARRA	RV12046332	ACREUNA	24/12/2020 06:45	24/12/2020 11:21	24/12/2020 06:45	24/12/2020 11:21	4,61	12	55,28	CHI
202012136404	CAIAPONIA	CP12245955	PALESTINA	24/12/2020 06:47	24/12/2020 12:08	24/12/2020 06:47	24/12/2020 12:08	5,34	41	218,79	CHI
202012136405	VIANOPOLIS	VN11387791	VIANOPOLIS	24/12/2020 06:47	24/12/2020 11:49	24/12/2020 06:47	24/12/2020 11:49	5,02	24	120,43	CHI
202012136406	ITAPACI	100035292	ITAPACI	24/12/2020 06:47	24/12/2020 08:43	24/12/2020 06:47	24/12/2020 08:43	1,93	1	1,93	CHI
202012136704	PIRANHAS	PH12170744	PIRANHAS	24/12/2020 06:48	24/12/2020 20:51	24/12/2020 06:48	24/12/2020 20:51	14,05	7	98,38	CHI
202012136415	SANTA FE DE GOIAS	RN21141199	BRITANIA	24/12/2020 06:50	24/12/2020 10:10	24/12/2020 06:50	24/12/2020 10:10	3,33	1	3,33	CHI
202012136831	GOIATUBA	GT12390091	GOIATUBA S2	24/12/2020 06:50	24/12/2020 14:50	24/12/2020 06:50	24/12/2020 14:50	7,99	9	71,94	CHI
202012136821	BALIZA	BH12358780	BOM JARDIM	24/12/2020 06:52	24/12/2020 14:27	24/12/2020 06:52	24/12/2020 14:27	7,59	16	121,44	CHI
202012136449	BURITINOPOLIS	BQ12149627	IACIARA S2	24/12/2020 06:55	24/12/2020 08:48	24/12/2020 06:55	24/12/2020 08:48	1,88	120	225,90	CHI
202012136823	PALMEIRAS DE GOIAS	PL12233331	PALMEIRAS	24/12/2020 06:55	24/12/2020 13:57	24/12/2020 06:55	24/12/2020 13:57	7,02	7	49,16	CHI
202012136459	COCALZINHO DE GOIAS	ZN12148908	AGUAS LINDAS DE GOIAS S2	24/12/2020 06:56	24/12/2020 08:35	24/12/2020 06:56	24/12/2020 08:35	1,65	2	3,29	CHI
202012136465	AMORINOPOLIS	AM12312073	IPORA	24/12/2020 06:57	24/12/2020 10:31	24/12/2020 06:57	24/12/2020 10:31	3,57	3	10,72	CHI
202012136467	PIRES DO RIO	PR12000028	PIRES DO RIO S1	24/12/2020 06:57	24/12/2020 13:02	24/12/2020 06:57	24/12/2020 13:02	6,09	5	30,45	CHI
202012137245	OURO VERDE DE GOIAS	OV12374484	NEROPOLIS S2	24/12/2020 06:57	24/12/2020 19:26	24/12/2020 06:57	24/12/2020 19:26	12,47	6	74,83	CHI
202012136475	PIRENOPOLIS	CB12215044	CORUMBA	24/12/2020 06:58	24/12/2020 11:18	24/12/2020 06:58	24/12/2020 11:18	4,33	2	8,66	CHI
202012136475	CORUMBA DE GOIAS	CB12215044	CORUMBA	24/12/2020 06:58	24/12/2020 11:18	24/12/2020 06:58	24/12/2020 11:18	4,33	23	99,62	CHI
202012136478	MINEIROS	MY21302960	PARQUE DAS EMAS	24/12/2020 06:58	25/12/2020 02:52	24/12/2020 06:58	25/12/2020 02:52	19,91	1	19,91	CHI
202012136479	PADRE BERNARDO	PB12000025	PADRE BERNARDO	24/12/2020 06:58	24/12/2020 13:45	24/12/2020 06:58	24/12/2020 13:45	6,77	9	60,97	CHI
202012136480	NIQUELANDIA	NQ12095769	NIQUELANDIA SUBTRANSMISSAO	24/12/2020 06:58	24/12/2020 10:48	24/12/2020 06:58	24/12/2020 10:48	3,82	3	11,47	CHI
202012136494	CAIAPONIA	CP12241166	PALESTINA	24/12/2020 07:00	24/12/2020 09:12	24/12/2020 07:00	24/12/2020 09:12	2,19	4	8,75	CHI
202012136503	RUBIATABA	RB12003205	RUBIATABA	24/12/2020 07:00	24/12/2020 09:42	24/12/2020 07:00	24/12/2020 09:42	2,69	6	16,15	CHI
202012136498	JUSSARA	JR12139962	JUSSARA	24/12/2020 07:01	24/12/2020 09:33	24/12/2020 07:01	24/12/2020 09:33	2,53	134	339,28	CHI
202012136498	FAZENDA NOVA	JR12139962	JUSSARA	24/12/2020 07:01	24/12/2020 09:33	24/12/2020 07:01	24/12/2020 09:33	2,53	6	15,19	CHI
202012136505	BELA VISTA DE GOIAS	SQ32088107	BELA VISTA S2	24/12/2020 07:02	24/12/2020 11:11	24/12/2020 07:02	24/12/2020 11:11	4,15	2	8,30	CHI
202012136505	SAO MIGUEL DO PASSA QUATRO	SQ32088107	BELA VISTA S2	24/12/2020 07:02	24/12/2020 11:11	24/12/2020 07:02	24/12/2020 11:11	4,15	13	53,93	CHI
202012136511	SANTA HELENA DE GOIAS	SH12131597	SANTA HELENA S1	24/12/2020 07:02	24/12/2020 08:47	24/12/2020 07:02	24/12/2020 08:47	1,74	5	8,70	CHI
202012136517	POSSE	PS12184932	IACIARA S2	24/12/2020 07:03	24/12/2020 09:31	24/12/2020 07:03	24/12/2020 09:31	2,46	5	12,28	CHI
202012136527	ORIZONA	OZ21248900	PIRES DO RIO S2	24/12/2020 07:05	24/12/2020 11:09	24/12/2020 07:05	24/12/2020 11:09	4,06	1	4,06	CHI
202012136742	SAO MIGUEL DO ARAGUAIA	SM12100371	SAO MIGUEL DO ARAGUAIA	24/12/2020 07:05	24/12/2020 14:52	24/12/2020 07:05	24/12/2020 14:52	7,78	76	591,07	CHI
202012136535	ALEXANIA	AX12353387	ALEXANIA	24/12/2020 07:06	24/12/2020 16:13	24/12/2020 07:06	24/12/2020 16:13	9,11	35	319,00	CHI
202012136566	GOIAS	GS12206751	MATRINCHA	24/12/2020 07:06	24/12/2020 13:20	24/12/2020 07:06	24/12/2020 13:20	6,23	34	211,79	CHI
202012138653	ITAPIRAPUA	IU12072498	MATRINCHA	24/12/2020 07:07	25/12/2020 00:42	24/12/2020 07:07	25/12/2020 00:42	17,58	3	52,73	CHI
202012136552	MONTA ALEGRE DE GOIAS	MA12218640	SAO DOMINGOS	24/12/2020 07:08	24/12/2020 09:56	24/12/2020 07:08	24/12/2020 09:56	2,80	5	13,99	CHI
202012136552	CAMPOS BELOS	MA12218640	SAO DOMINGOS	24/12/2020 07:08	24/12/2020 09:56	24/12/2020 07:08	24/12/2020 09:56	2,80	2	5,59	CHI
202012136555	APARECIDA DO RIO DOCE	JT12063301	JATAI S1	24/12/2020 07:08	24/12/2020 15:42	24/12/2020 07:08	24/12/2020 15:42	8,56	2	17,12	CHI
202012136555	JATAI	JT12063301	JATAI S1	24/12/2020 07:08	24/12/2020 15:42	24/12/2020 07:08	24/12/2020 15:42	8,56	3	25,69	CHI
202012136559	GUAPO	GA12405610	GUAPO S1	24/12/2020 07:08	24/12/2020 13:14	24/12/2020 07:08	24/12/2020 13:14	6,09	22	133,91	CHI
202012137619	CAIAPONIA	CP12349672	CAIAPONIA	24/12/2020 07:08	24/12/2020 10:46	24/12/2020 07:08	24/12/2020 10:46	3,63	7	25,39	CHI



202012136627	ALTO HORIZONTE	AJ12204148	SANTA TEREZINHA	24/12/2020 07:11	24/12/2020 09:47	24/12/2020 07:11	24/12/2020 09:47	2,59	14	36,26	CHI
202012137094	FAINA	FC12310647	GOIAS	24/12/2020 07:11	24/12/2020 17:19	24/12/2020 07:11	24/12/2020 17:19	10,12	2	20,25	CHI
202012136590	PARAUNA	JD12377478	PALMEIRAS	24/12/2020 07:12	24/12/2020 09:00	24/12/2020 07:12	24/12/2020 09:00	1,80	9	16,16	CHI
202012136593	MARA ROSA	MQ12150566	MARA ROSA	24/12/2020 07:12	24/12/2020 09:40	24/12/2020 07:12	24/12/2020 09:40	2,46	7	17,19	CHI
202012136593	ESTRELA DO NORTE	MQ12150566	MARA ROSA	24/12/2020 07:12	24/12/2020 09:40	24/12/2020 07:12	24/12/2020 09:40	2,46	7	17,19	CHI
202012136686	JARAGUA	JA12414669	JARAGUA	24/12/2020 07:12	24/12/2020 15:08	24/12/2020 07:12	24/12/2020 15:08	7,92	200	1583,89	CHI
202012136595	APARECIDA DE GOIANIA	12296030	CARAJAS S1	24/12/2020 07:13	24/12/2020 11:08	24/12/2020 07:13	24/12/2020 11:08	3,92	1	3,92	CHI
202012136753	DISTRITO FEDERAL	NJ12290513	MARAJOARA	24/12/2020 07:14	24/12/2020 08:56	24/12/2020 07:14	24/12/2020 08:56	1,68	11	18,53	CHI
202012136631	BRITANIA	BT18073348TS	BRITANIA	24/12/2020 07:15	24/12/2020 20:36	24/12/2020 07:15	24/12/2020 20:36	13,34	51	680,45	CHI
202012136619	ABADIA DE GOIAS	GN12057790	CARAJAS S1	24/12/2020 07:16	24/12/2020 13:23	24/12/2020 07:16	24/12/2020 13:23	6,10	2	12,21	CHI
202012136630	ITUMBIARA	BG12384533	ITUMBIARA VELHA S2	24/12/2020 07:18	24/12/2020 12:07	24/12/2020 07:18	24/12/2020 12:07	4,82	30	144,47	CHI
202012136641	GOIANIA	GN11002068	GOIANIA LESTE S1	24/12/2020 07:19	24/12/2020 13:17	24/12/2020 08:30	24/12/2020 13:17	4,78	226	1081,10	CHI
202012136900	NOVA CRIXAS	NA12229095	NOVA CRIXAS	24/12/2020 07:19	24/12/2020 11:13	24/12/2020 07:19	24/12/2020 11:13	3,89	31	120,50	CHI
202012137268	DOVERLANDIA	DV12138342	CAIAPONIA	24/12/2020 07:20	24/12/2020 16:40	24/12/2020 07:20	24/12/2020 16:40	9,33	9	83,99	CHI
202012136787	BOM JARDIM DE GOIAS	BM12065606	BOM JARDIM	24/12/2020 07:21	24/12/2020 09:54	24/12/2020 07:21	24/12/2020 09:54	2,55	12	30,57	CHI
202012136674	GOIANIA	13479556	GOIANIA LESTE S3	24/12/2020 07:24	24/12/2020 11:40	24/12/2020 07:24	24/12/2020 11:40	4,26	1	4,26	CHI
202012137369	MATRINCHA	MP12362399	MATRINCHA	24/12/2020 07:24	24/12/2020 18:16	24/12/2020 07:24	24/12/2020 18:16	10,85	4	43,42	CHI
202012138205	URUACU	UR12190194	URUACU	24/12/2020 07:24	24/12/2020 16:19	24/12/2020 07:24	24/12/2020 16:19	8,91	7	62,34	CHI
202012136695	PIRES DO RIO	OZ12084893RE	PIRES DO RIO S2	24/12/2020 07:26	24/12/2020 13:47	24/12/2020 07:26	24/12/2020 13:47	6,35	11	69,82	CHI
202012136695	VIANOPOLIS	OZ12084893RE	PIRES DO RIO S2	24/12/2020 07:26	24/12/2020 13:47	24/12/2020 07:26	24/12/2020 13:47	6,35	73	463,35	CHI
202012136695	ORIZONA	OZ12084893RE	PIRES DO RIO S2	24/12/2020 07:26	24/12/2020 13:47	24/12/2020 07:26	24/12/2020 13:47	6,35	55	349,10	CHI
202012136695	SAO MIGUEL DO PASSA QUATRO	OZ12084893RE	PIRES DO RIO S2	24/12/2020 07:26	24/12/2020 13:47	24/12/2020 07:26	24/12/2020 13:47	6,35	2	12,69	CHI
202012137675	GOIATUBA	GT12000228	GOIATUBA S2	24/12/2020 07:26	24/12/2020 12:13	24/12/2020 07:26	24/12/2020 12:13	4,77	174	830,51	CHI
202012136718	ANICUNS	AC12304639	ANICUNS	24/12/2020 07:27	24/12/2020 11:18	24/12/2020 07:27	24/12/2020 11:18	3,84	18	69,05	CHI
202012136718	AMERICANO DO BRASIL	AC12304639	ANICUNS	24/12/2020 07:27	24/12/2020 11:18	24/12/2020 07:27	24/12/2020 11:18	3,84	1	3,84	CHI
202012136718	ADELANDIA	AC12304639	FIRMINOPOLIS S2	24/12/2020 07:27	24/12/2020 11:18	24/12/2020 07:27	24/12/2020 11:18	3,84	37	141,94	CHI
202012136718	ANICUNS	AC12304639	FIRMINOPOLIS S2	24/12/2020 07:27	24/12/2020 11:18	24/12/2020 07:27	24/12/2020 11:18	3,84	234	897,65	CHI
202012137374	PIRENOPOLIS	PV12382895	CORUMBA	24/12/2020 07:27	24/12/2020 16:01	24/12/2020 07:27	24/12/2020 16:01	8,57	6	51,40	CHI
202012136720	PONTALINA	PK12080060	PONTALINA	24/12/2020 07:29	24/12/2020 09:03	24/12/2020 07:29	24/12/2020 09:03	1,55	27	41,87	CHI
202012137604	PORTELANDIA	PW12226596	PARQUE DAS EMAS	24/12/2020 07:29	24/12/2020 10:28	24/12/2020 07:29	24/12/2020 10:28	2,97	3	8,92	CHI
202012136729	BOM JESUS DE GOIAS	IT12034458RE	CACHOEIRA DOURADA	24/12/2020 07:30	24/12/2020 10:17	24/12/2020 07:30	24/12/2020 10:17	2,77	3	8,32	CHI
202012136729	PANAMA	IT12034458RE	CACHOEIRA DOURADA	24/12/2020 07:30	24/12/2020 10:17	24/12/2020 07:30	24/12/2020 10:17	2,77	13	36,06	CHI
202012136729	ITUMBIARA	IT12034458RE	CACHOEIRA DOURADA	24/12/2020 07:30	24/12/2020 10:17	24/12/2020 07:30	24/12/2020 10:17	2,77	67	185,85	CHI
202012136730	IPAMERI	IP12079464	CAMPO ALEGRE DE GOIAS	24/12/2020 07:30	24/12/2020 11:01	24/12/2020 07:30	24/12/2020 11:01	3,50	4	14,02	CHI
202012138065	ITARUMA	IM12160235	ITAJA S2	24/12/2020 07:30	24/12/2020 13:58	24/12/2020 07:30	24/12/2020 13:58	6,46	13	84,00	CHI
202012136751	GOIATUBA	JV12161205	BOM JESUS DE GOIAS	24/12/2020 07:33	24/12/2020 10:30	24/12/2020 07:33	24/12/2020 10:30	2,95	3	8,85	CHI
202012136755	ITARUMA	IM12107442	CACHOEIRA ALTA	24/12/2020 07:33	24/12/2020 10:11	24/12/2020 07:33	24/12/2020 10:11	2,63	40	105,07	CHI
202012136756	CATALAO	CT12149150	CATALAO S1	24/12/2020 07:33	24/12/2020 09:28	24/12/2020 07:33	24/12/2020 09:28	1,91	2	3,81	CHI
202012136768	AGUA LIMPA	AL12392069	VILA CORUMBA	24/12/2020 07:36	24/12/2020 11:55	24/12/2020 07:36	24/12/2020 11:55	4,31	2	8,61	CHI
202012136768	CORUMBAIBA	AL12392069	VILA CORUMBA	24/12/2020 07:36	24/12/2020 11:55	24/12/2020 07:36	24/12/2020 11:55	4,31	1	4,31	CHI
202012136772	CAIAPONIA	PH12170753	PIRANHAS	24/12/2020 07:36	24/12/2020 12:03	24/12/2020 07:36	24/12/2020 12:03	4,44	11	48,82	CHI
202012136772	PIRANHAS	PH12170753	PIRANHAS	24/12/2020 07:36	24/12/2020 12:03	24/12/2020 07:36	24/12/2020 12:03	4,44	1	4,44	CHI
202012136777	LAGOA SANTA	IJ12029167	ITAJA S2	24/12/2020 07:37	24/12/2020 14:55	24/12/2020 07:37	24/12/2020 14:55	7,30	2	14,59	CHI
202012136848	MOIPORA	MO12259529	IPORA	24/12/2020 07:37	24/12/2020 14:04	24/12/2020 07:37	24/12/2020 14:04	6,44	9	57,98	CHI
202012137044	SAO MIGUEL DO PASSA QUATRO	SQ12231379	CRISTIANOPOLIS	24/12/2020 07:37	24/12/2020 11:52	24/12/2020 07:37	24/12/2020 11:52	4,25	14	59,46	CHI
202012137044	VIANOPOLIS	SQ12231379	CRISTIANOPOLIS	24/12/2020 07:37	24/12/2020 11:52	24/12/2020 07:37	24/12/2020 11:52	4,25	7	29,73	CHI
202012136786	SANTA HELENA DE GOIAS	SH12387441	SANTA HELENA S1	24/12/2020 07:38	24/12/2020 10:49	24/12/2020 07:38	24/12/2020 10:49	3,17	3	9,52	CHI
202012136793	JARAGUA	JA12382495RE	JARAGUA	24/12/2020 07:39	24/12/2020 17:39	24/12/2020 07:39	24/12/2020 17:39	10,00	49	489,82	CHI
202012136793	PIRENOPOLIS	JA12382495RE	JARAGUA	24/12/2020 07:39	24/12/2020 17:39	24/12/2020 07:39	24/12/2020 17:39	10,00	46	459,83	CHI
202012136964	CAIAPONIA	CP12395437	PALESTINA	24/12/2020 07:40	24/12/2020 08:54	24/12/2020 07:40	24/12/2020 08:54	1,23	3	3,68	CHI
202012136964	PALESTINA DE GOIAS	CP12395437	PALESTINA	24/12/2020 07:40	24/12/2020 08:54	24/12/2020 07:40	24/12/2020 08:54	1,23	5	6,13	CHI

202012136810	NOVA IGUACU DE GOIAS	NH12319257	SANTA TEREZINHA	24/12/2020 07:41	24/12/2020 10:52	24/12/2020 07:41	24/12/2020 10:52	3,17	4	12,67	CHI
202012137550	CORREGO DO OURO	CO12299161	FIRMINOPOLIS S2	24/12/2020 07:42	24/12/2020 10:25	24/12/2020 07:42	24/12/2020 10:25	2,70	3	8,11	CHI
202012136817	PLANALTINA	PI12085617RE	PLANALTINA	24/12/2020 07:43	24/12/2020 08:16	24/12/2020 07:43	24/12/2020 08:16	0,55	416	228,68	CHI
202012136822	MORRINHOS	MR12016157	GOIATUBA S2	24/12/2020 07:43	24/12/2020 11:22	24/12/2020 07:43	24/12/2020 11:22	3,64	1	3,64	CHI
202012137430	JARAGUA	JA12112518	JARAGUA	24/12/2020 07:43	24/12/2020 15:16	24/12/2020 07:43	24/12/2020 15:16	7,54	15	113,05	CHI
202012136871	GOIANIA	GN11001556	GOIANIA LESTE S1	24/12/2020 07:45	24/12/2020 10:00	24/12/2020 08:27	24/12/2020 10:00	1,55	1	1,55	CHI
202012136856	ALTO PARAISO DE GOIAS	NQ12234731	NIQUELANDIA SUBTRANSMISSAO	24/12/2020 07:47	24/12/2020 10:52	24/12/2020 07:47	24/12/2020 10:52	3,07	11	33,81	CHI
202012136856	NIQUELANDIA	NQ12234731	NIQUELANDIA SUBTRANSMISSAO	24/12/2020 07:47	24/12/2020 10:52	24/12/2020 07:47	24/12/2020 10:52	3,07	13	39,96	CHI
202012136856	SAO JOAO D ALIANCA	NQ12234731	NIQUELANDIA SUBTRANSMISSAO	24/12/2020 07:47	24/12/2020 10:52	24/12/2020 07:47	24/12/2020 10:52	3,07	1	3,07	CHI
202012136862	SANTA RITA DO ARAGUAIA	SU12188579	PARQUE DAS EMAS	24/12/2020 07:48	24/12/2020 12:33	24/12/2020 07:48	24/12/2020 12:33	4,75	5	23,75	CHI
202012136880	APORE	AE12000045	ITAJA S1	24/12/2020 07:50	24/12/2020 23:32	24/12/2020 07:50	24/12/2020 23:32	15,69	2	31,39	CHI
202012136880	DISTRITO FEDERAL	AE12000045	ITAJA S1	24/12/2020 07:50	24/12/2020 23:32	24/12/2020 07:50	24/12/2020 23:32	15,69	1	15,69	CHI
202012136880	JATAI	AE12000045	ITAJA S1	24/12/2020 07:50	24/12/2020 23:32	24/12/2020 07:50	24/12/2020 23:32	15,69	1	15,69	CHI
202012136885	ITAPACI	IW12360147	RUBIATABA	24/12/2020 07:50	24/12/2020 10:48	24/12/2020 07:50	24/12/2020 10:48	2,96	5	14,78	CHI
202012136887	MINEIROS	MY12393282	PARQUE DAS EMAS	24/12/2020 07:51	25/12/2020 12:08	24/12/2020 07:51	25/12/2020 12:08	28,28	2	56,55	CHI
202012136887	SANTA RITA DO ARAGUAIA	MY12393282	PARQUE DAS EMAS	24/12/2020 07:51	25/12/2020 12:08	24/12/2020 07:51	25/12/2020 12:08	28,28	1	28,28	CHI
202012136989	JOVIANIA	AD12074096	GOIATUBA S1	24/12/2020 07:53	24/12/2020 09:13	24/12/2020 07:53	24/12/2020 09:13	1,33	4	5,33	CHI
202012136989	PONTALINA	AD12074096	GOIATUBA S1	24/12/2020 07:53	24/12/2020 09:13	24/12/2020 07:53	24/12/2020 09:13	1,33	1	1,33	CHI
202012137169	CRISTALINA	KR12133610	CRISTALINA S2	24/12/2020 07:53	24/12/2020 09:55	24/12/2020 07:53	24/12/2020 09:55	2,03	12	24,40	CHI
202012136914	ANAPOLIS	AN12259042	ANAPOLIS UNIVERSITARIO S2	24/12/2020 07:54	24/12/2020 10:06	24/12/2020 07:54	24/12/2020 10:06	2,19	8	17,54	CHI
202012137432	PLANALTINA	PI12146090	SAO JOAO D ALIANCA	24/12/2020 07:54	24/12/2020 11:20	24/12/2020 07:54	24/12/2020 11:20	3,42	79	270,29	CHI
202012137238	HIDROLANDIA	HD12006265	INDEPENDENCIA S1	24/12/2020 07:55	24/12/2020 08:50	24/12/2020 07:55	24/12/2020 08:50	0,91	21	19,02	CHI
202012136935	CACU	CC12035157	CACHOEIRA ALTA	24/12/2020 07:57	24/12/2020 12:19	24/12/2020 07:57	24/12/2020 12:19	4,36	10	43,59	CHI
202012137538	ITUMBIARA	IT12049977	CACHOEIRA DOURADA	24/12/2020 07:57	24/12/2020 14:36	24/12/2020 07:57	24/12/2020 14:36	6,63	10	66,34	CHI
202012136941	ITAUCU	IX12317351	INHUMAS S1	24/12/2020 07:58	24/12/2020 11:19	24/12/2020 07:58	24/12/2020 11:19	3,35	2	6,69	CHI
202012136947	PILAR DE GOIAS	GG12171805RE	SANTA TEREZINHA	24/12/2020 07:59	24/12/2020 10:23	24/12/2020 07:59	24/12/2020 10:23	2,38	60	143,05	CHI
202012136949	GOIANDIRA	GD12127562	CATALAO S1	24/12/2020 08:00	24/12/2020 11:33	24/12/2020 08:00	24/12/2020 11:33	3,55	2	7,09	CHI
202012136953	MOZARLANDIA	AZ12042877	MOZARLANDIA	24/12/2020 08:00	24/12/2020 09:19	24/12/2020 08:00	24/12/2020 09:19	1,31	2	2,62	CHI
202012136953	ARAGUAPAZ	AZ12042877	MOZARLANDIA	24/12/2020 08:00	24/12/2020 09:19	24/12/2020 08:00	24/12/2020 09:19	1,31	87	113,95	CHI
202012136963	CATALAO	CT12333638RE	CATALAO S1	24/12/2020 08:01	24/12/2020 12:02	24/12/2020 08:01	24/12/2020 12:02	4,01	64	256,78	CHI
202012137275	VICENTINOPOLIS	VI12218231	VICENTINOPOLIS	24/12/2020 08:02	24/12/2020 10:23	24/12/2020 08:02	24/12/2020 10:23	2,34	3	7,01	CHI
202012136981	CRISTALINA	KR12237929	CRISTALINA S2	24/12/2020 08:03	24/12/2020 13:09	24/12/2020 08:03	24/12/2020 13:09	5,10	1	5,10	CHI
202012136991	FORMOSA	FA21146213	SAO JOAO D ALIANCA	24/12/2020 08:03	24/12/2020 11:49	24/12/2020 08:03	24/12/2020 11:49	3,77	1	3,77	CHI
202012136993	CATALAO	CT12358331	CATALAO S1	24/12/2020 08:03	24/12/2020 11:36	24/12/2020 08:03	24/12/2020 11:36	3,54	5	17,68	CHI
202012137186	ITABERAI	IB12075677	ARACU	24/12/2020 08:03	24/12/2020 11:25	24/12/2020 08:03	24/12/2020 11:25	3,36	15	50,44	CHI
202012137436	TURVELANDIA	TD12301348LD	IPEGUARI	24/12/2020 08:03	24/12/2020 10:14	24/12/2020 08:03	24/12/2020 10:14	2,18	6	13,08	CHI
202012136996	GOIANIA	GN11323179	ATLANTICO S1	24/12/2020 08:04	24/12/2020 11:19	24/12/2020 08:04	24/12/2020 11:19	3,24	2	6,49	CHI
202012137003	CAIAPONIA	CP12252503	CAIAPONIA	24/12/2020 08:05	24/12/2020 12:32	24/12/2020 08:05	24/12/2020 12:32	4,45	6	26,68	CHI
202012137373	SANTA HELENA DE GOIAS	TD12025737	RIO DOS BOIS	24/12/2020 08:06	24/12/2020 10:19	24/12/2020 08:06	24/12/2020 10:19	2,21	18	39,83	CHI
202012137373	TURVELANDIA	TD12025737	RIO DOS BOIS	24/12/2020 08:06	24/12/2020 10:19	24/12/2020 08:06	24/12/2020 10:19	2,21	66	146,04	CHI
202012137373	ACREUNA	TD12025737	RIO DOS BOIS	24/12/2020 08:06	24/12/2020 10:19	24/12/2020 08:06	24/12/2020 10:19	2,21	26	57,53	CHI
202012136328	PEROLANDIA	DP21358893	JATAI S1	24/12/2020 08:07	24/12/2020 14:25	24/12/2020 08:07	24/12/2020 14:25	6,29	1	6,29	CHI
202012137571	CATALAO	CT12149194	CATALAO S1	24/12/2020 08:07	24/12/2020 12:00	24/12/2020 08:07	24/12/2020 12:00	3,87	14	54,19	CHI
202012137034	PADRE BERNARDO	PB12163209	PADRE BERNARDO	24/12/2020 08:08	24/12/2020 11:18	24/12/2020 08:08	24/12/2020 11:18	3,17	1	3,17	CHI
202012137049	URUCU	UR11333935	URUCU	24/12/2020 08:09	24/12/2020 11:57	24/12/2020 08:09	24/12/2020 11:57	3,80	32	121,65	CHI
202012137052	HEITORAI	HE12019118	ITAPURANGA	24/12/2020 08:10	24/12/2020 12:06	24/12/2020 08:10	24/12/2020 12:06	3,93	1	3,93	CHI
202012137315	CAIAPONIA	CP12248981	CAIAPONIA	24/12/2020 08:10	24/12/2020 12:30	24/12/2020 08:10	24/12/2020 12:30	4,32	8	34,54	CHI
202012139309	SAO LUIZ DO NORTE	SZ12258502	BARRO ALTO	24/12/2020 08:10	24/12/2020 21:45	24/12/2020 08:10	24/12/2020 21:45	13,57	2	27,14	CHI
202012137066	MINEIROS	1390062901	PARQUE DAS EMAS	24/12/2020 08:11	24/12/2020 14:09	24/12/2020 08:11	24/12/2020 14:09	5,97	1	5,97	CHI
202012137682	SANTA RITA DO NOVO DESTINO	DF12382411	BARRO ALTO	24/12/2020 08:11	24/12/2020 11:39	24/12/2020 08:11	24/12/2020 11:39	3,46	8	27,64	CHI
202012137152	PORANGATU	TA12114216	NOVO PLANALTO	24/12/2020 08:12	25/12/2020 08:25	24/12/2020 08:12	25/12/2020 08:25	24,21	6	145,26	CHI

202012137139	ARAGARCAS	AG12140067	ARAGARCAS	24/12/2020 08:13	24/12/2020 10:00	24/12/2020 08:13	24/12/2020 10:00	1,77	66	117,08	CHI
202012137324	GAMELEIRA DE GOIAS	LB12000008	DAIA S2	24/12/2020 08:13	24/12/2020 10:42	24/12/2020 08:13	24/12/2020 10:42	2,47	16	39,57	CHI
202012137324	LEOPOLDO DE BULHOES	LB12000008	DAIA S2	24/12/2020 08:13	24/12/2020 10:42	24/12/2020 08:13	24/12/2020 10:42	2,47	160	395,73	CHI
202012137324	SILVANIA	LB12000008	DAIA S2	24/12/2020 08:13	24/12/2020 10:42	24/12/2020 08:13	24/12/2020 10:42	2,47	98	242,39	CHI
202012137664	LEOPOLDO DE BULHOES	LB21324175	DAIA S2	24/12/2020 08:13	24/12/2020 12:41	24/12/2020 08:13	24/12/2020 12:41	4,46	1	4,46	CHI
202012137102	SAO FRANCISCO DE GOIAS	490020021	SAO FRANCISCO DE GOIAS	24/12/2020 08:14	24/12/2020 14:55	24/12/2020 08:14	24/12/2020 14:55	6,68	1	6,68	CHI
202012137108	CRIXAS	RB12039306	RUBIATABA	24/12/2020 08:15	24/12/2020 19:03	24/12/2020 08:15	24/12/2020 19:03	10,79	1	10,79	CHI
202012137350	PETROLINA DE GOIAS	PG12255953	PETROLINA	24/12/2020 08:17	24/12/2020 11:51	24/12/2020 08:17	24/12/2020 11:51	3,56	117	416,16	CHI
202012137350	OURO VERDE DE GOIAS	PG12255953	PETROLINA	24/12/2020 08:17	24/12/2020 11:51	24/12/2020 08:17	24/12/2020 11:51	3,56	25	88,92	CHI
202012137350	DAMOLANDIA	PG12255953	PETROLINA	24/12/2020 08:17	24/12/2020 11:51	24/12/2020 08:17	24/12/2020 11:51	3,56	1	3,56	CHI
202012138084	VARJAO	AO32097674	GUAPO S2	24/12/2020 08:17	24/12/2020 12:23	24/12/2020 08:17	24/12/2020 12:23	4,09	4	16,38	CHI
202012137159	CRIXAS	CX12158232	SERRA DO OURO	24/12/2020 08:19	24/12/2020 11:08	24/12/2020 08:19	24/12/2020 11:08	2,81	5	14,04	CHI
202012132848	FAZENDA NOVA	NB12034635	JUSSARA	24/12/2020 08:21	24/12/2020 09:38	24/12/2020 08:21	24/12/2020 09:38	1,29	33	42,41	CHI
202012132848	NOVO BRASIL	NB12034635	JUSSARA	24/12/2020 08:21	24/12/2020 09:38	24/12/2020 08:21	24/12/2020 09:38	1,29	8	10,28	CHI
202012132848	JUSSARA	NB12034635	JUSSARA	24/12/2020 08:21	24/12/2020 09:38	24/12/2020 08:21	24/12/2020 09:38	1,29	1	1,29	CHI
202012137177	URUACU	NQ12235363LD	NIQUELANDIA SUBTRANSMISSAO	24/12/2020 08:21	24/12/2020 12:07	24/12/2020 08:21	24/12/2020 12:07	3,76	1	3,76	CHI
202012137177	NIQUELANDIA	NQ12235363LD	NIQUELANDIA SUBTRANSMISSAO	24/12/2020 08:21	24/12/2020 12:07	24/12/2020 08:21	24/12/2020 12:07	3,76	1	3,76	CHI
202012137187	CAMPESTRE DE GOIAS	GA12008543	GUAPO S2	24/12/2020 08:22	24/12/2020 15:12	24/12/2020 08:22	24/12/2020 15:12	6,82	12	81,88	CHI
202012137187	GUAPO	GA12008543	GUAPO S2	24/12/2020 08:22	24/12/2020 15:12	24/12/2020 08:22	24/12/2020 15:12	6,82	29	197,88	CHI
202012136388	FAINA	FC12332552LD	GOIAS	24/12/2020 08:24	24/12/2020 10:54	24/12/2020 08:24	24/12/2020 10:54	2,50	3	7,50	CHI
202012137203	VICENTINOPOLIS	VI12071025	VICENTINOPOLIS	24/12/2020 08:24	24/12/2020 09:37	24/12/2020 08:24	24/12/2020 09:37	1,21	556	674,46	CHI
202012137213	PADRE BERNARDO	PB12163215	PADRE BERNARDO	24/12/2020 08:25	24/12/2020 11:52	24/12/2020 08:25	24/12/2020 11:52	3,45	280	965,69	CHI
202012137213	DISTRITO FEDERAL	PB12163215	PADRE BERNARDO	24/12/2020 08:25	24/12/2020 11:52	24/12/2020 08:25	24/12/2020 11:52	3,45	3	10,35	CHI
202012137227	SANTO ANTONIO DA BARRA	BZ12359446	ACREUNA	24/12/2020 08:26	24/12/2020 12:50	24/12/2020 08:26	24/12/2020 12:50	4,39	1	4,39	CHI
202012137233	LUZIANIA	LZ12344835	MARAJOARA	24/12/2020 08:26	24/12/2020 10:44	24/12/2020 08:26	24/12/2020 10:44	2,29	5	11,45	CHI
202012137939	PIRANHAS	PH12170751	PIRANHAS	24/12/2020 08:26	24/12/2020 16:16	24/12/2020 08:26	24/12/2020 16:16	7,83	8	62,67	CHI
202012137246	ARACU	AR12188600	ARACU	24/12/2020 08:28	24/12/2020 16:08	24/12/2020 08:28	24/12/2020 16:08	7,66	2	15,32	CHI
202012137250	BRITANIA	BT12250825	BRITANIA	24/12/2020 08:28	24/12/2020 17:23	24/12/2020 08:28	24/12/2020 17:23	8,90	4	35,62	CHI
202012137258	SANTA FE DE GOIAS	RN12057000	BRITANIA	24/12/2020 08:29	24/12/2020 14:29	24/12/2020 08:29	24/12/2020 14:29	6,00	1	6,00	CHI
202012137258	JUSSARA	RN12057000	BRITANIA	24/12/2020 08:29	24/12/2020 14:29	24/12/2020 08:29	24/12/2020 14:29	6,00	4	24,00	CHI
202012137269	SAO JOAO D ALIANCA	JL12264714	SAO JOAO D ALIANCA	24/12/2020 08:30	24/12/2020 12:59	24/12/2020 08:30	24/12/2020 12:59	4,48	33	147,78	CHI
202012137270	MUNDO NOVO DE GOIAS	MH12035552	NOVA CRIXAS	24/12/2020 08:30	24/12/2020 09:55	24/12/2020 08:30	24/12/2020 09:55	1,41	82	115,67	CHI
202012137272	MORRINHOS	MR12000252	MORRINHOS	24/12/2020 08:30	24/12/2020 16:47	24/12/2020 08:30	24/12/2020 16:47	8,28	6	49,65	CHI
202012137276	PORANGATU	PO12378923	PORANGATU	24/12/2020 08:30	24/12/2020 11:50	24/12/2020 08:30	24/12/2020 11:50	3,32	2	6,64	CHI
202012137279	NOVA IGUACU DE GOIAS	NH12281692	SANTA TEREZINHA	24/12/2020 08:30	24/12/2020 11:55	24/12/2020 08:30	24/12/2020 11:55	3,40	5	17,00	CHI
202012137293	PALMINOPOLIS	PP12312499RE	PALMEIRAS	24/12/2020 08:32	24/12/2020 14:20	24/12/2020 08:32	24/12/2020 14:20	5,80	69	399,89	CHI
202012137293	JANDAIA	PP12312499RE	PALMEIRAS	24/12/2020 08:32	24/12/2020 14:20	24/12/2020 08:32	24/12/2020 14:20	5,80	29	168,07	CHI
202012137536	SAO JOAO D ALIANCA	JL12049201	SAO JOAO D ALIANCA	24/12/2020 08:33	24/12/2020 13:37	24/12/2020 08:33	24/12/2020 13:37	5,06	95	481,07	CHI
202012137786	MORRINHOS	RQ12246571	MORRINHOS	24/12/2020 08:33	24/12/2020 16:05	24/12/2020 08:33	24/12/2020 16:05	7,53	13	97,91	CHI
202012137786	RIO QUENTE	RQ12246571	MORRINHOS	24/12/2020 08:33	24/12/2020 16:05	24/12/2020 08:33	24/12/2020 16:05	7,53	17	128,04	CHI
202012137618	FAZENDA NOVA	FN12060693	IPORA	24/12/2020 08:34	25/12/2020 02:29	24/12/2020 08:34	25/12/2020 02:29	17,91	11	196,99	CHI
202012137314	PORTELANDIA	10032468839	PARQUE DAS EMAS	24/12/2020 08:35	24/12/2020 17:26	24/12/2020 08:35	24/12/2020 17:26	8,86	1	8,86	CHI
202012137545	PALMELO	PR12000096RE	PIRES DO RIO S1	24/12/2020 08:42	24/12/2020 12:00	24/12/2020 08:42	24/12/2020 12:00	3,29	6	19,74	CHI
202012137545	PIRES DO RIO	PR12000096RE	PIRES DO RIO S1	24/12/2020 08:42	24/12/2020 12:00	24/12/2020 08:42	24/12/2020 12:00	3,29	22	72,38	CHI
202012138180	CRIXAS	NA12220357	MOZARLANDIA	24/12/2020 08:42	24/12/2020 13:46	24/12/2020 08:42	24/12/2020 13:46	5,06	2	10,12	CHI
202012138180	NOVA CRIXAS	NA12220357	MOZARLANDIA	24/12/2020 08:42	24/12/2020 13:46	24/12/2020 08:42	24/12/2020 13:46	5,06	6	30,37	CHI
202012137378	GOIANDIRA	CT12000088	CATALAO S1	24/12/2020 08:43	24/12/2020 15:17	24/12/2020 08:43	24/12/2020 15:17	6,55	2	13,11	CHI
202012137378	CATALAO	CT12000088	CATALAO S1	24/12/2020 08:43	24/12/2020 15:17	24/12/2020 08:43	24/12/2020 15:17	6,55	2	13,11	CHI
202012137388	APARECIDA DE GOIANIA	AP11038685	CEPAIGO S1	24/12/2020 08:44	24/12/2020 12:04	24/12/2020 08:44	24/12/2020 12:04	3,32	23	76,29	CHI
202012137902	PARAUNA	JD12310698	PALMEIRAS	24/12/2020 08:45	24/12/2020 11:47	24/12/2020 08:45	24/12/2020 11:47	3,03	16	48,44	CHI
202012137417	MORRINHOS	MR11275841	GOIATUBA S1	24/12/2020 08:48	24/12/2020 11:38	24/12/2020 08:48	24/12/2020 11:38	2,83	1	2,83	CHI

202012137422	RIO VERDE	RV21027703	RIO VERDE S1	24/12/2020 08:48	24/12/2020 16:22	24/12/2020 08:48	24/12/2020 16:22	7,56	1	7,56	CHI
202012137656	ITAUCU	SR12018997	INHUMAS S1	24/12/2020 08:49	24/12/2020 11:05	24/12/2020 08:49	24/12/2020 11:05	2,25	5	11,26	CHI
202012137656	SANTA ROSA DE GOIAS	SR12018997	INHUMAS S1	24/12/2020 08:49	24/12/2020 11:05	24/12/2020 08:49	24/12/2020 11:05	2,25	2	4,50	CHI
202012137484	PONTALINA	PK12047065	PONTALINA	24/12/2020 08:51	24/12/2020 12:00	24/12/2020 08:51	24/12/2020 12:00	3,15	10	31,50	CHI
202012138106	HIDROLANDIA	HD12000067	INDEPENDENCIA S1	24/12/2020 08:54	24/12/2020 12:18	24/12/2020 08:54	24/12/2020 12:18	3,40	11	37,36	CHI
202012138106	ARAGOIANIA	HD12000067	INDEPENDENCIA S1	24/12/2020 08:54	24/12/2020 12:18	24/12/2020 08:54	24/12/2020 12:18	3,40	5	16,98	CHI
202012137469	TURVELANDIA	CL12313345	RIO DOS BOIS	24/12/2020 08:55	24/12/2020 13:19	24/12/2020 08:55	24/12/2020 13:19	4,39	1	4,39	CHI
202012137633	MORRO AGUDO DE GOIAS	RB12292120	RUBIATABA	24/12/2020 08:55	24/12/2020 14:16	24/12/2020 08:55	24/12/2020 14:16	5,34	5	26,68	CHI
202012137633	RUBIATABA	RB12292120	RUBIATABA	24/12/2020 08:55	24/12/2020 14:16	24/12/2020 08:55	24/12/2020 14:16	5,34	4	21,35	CHI
202012137500	CALDAS NOVAS	CN11204419	CALDAS NOVAS S2	24/12/2020 08:59	24/12/2020 17:53	24/12/2020 08:59	24/12/2020 17:44	8,76	31	271,47	CHI
202012137500	CALDAS NOVAS	CN12120269LD	CALDAS NOVAS S2	24/12/2020 08:59	24/12/2020 17:53	24/12/2020 12:55	24/12/2020 17:53	4,98	62	308,54	CHI
202012137509	RIO VERDE	630172262	RIO VERDE S2	24/12/2020 09:00	24/12/2020 12:23	24/12/2020 09:00	24/12/2020 12:23	3,39	1	3,39	CHI
202012137515	BALIZA	BH12331383	CAIAPONIA	24/12/2020 09:00	24/12/2020 20:45	24/12/2020 09:00	24/12/2020 20:45	11,73	9	105,61	CHI
202012137637	ARAGUAPAZ	AZ12010438	MOZARLANDIA	24/12/2020 09:01	24/12/2020 10:45	24/12/2020 09:01	24/12/2020 10:45	1,72	3	5,16	CHI
202012137537	ARAGOIANIA	AO32000284	GUAPO S2	24/12/2020 09:04	24/12/2020 11:01	24/12/2020 09:04	24/12/2020 11:01	1,94	3	5,81	CHI
202012137547	JATAI	JT12205177	JATAI S1	24/12/2020 09:06	24/12/2020 12:39	24/12/2020 09:06	24/12/2020 12:39	3,55	3	10,64	CHI
202012137862	ALOANDIA	AD12293139	GOIATUBA S1	24/12/2020 09:07	24/12/2020 10:31	24/12/2020 09:07	24/12/2020 10:31	1,40	7	9,79	CHI
202012137862	PONTALINA	AD12293139	GOIATUBA S1	24/12/2020 09:07	24/12/2020 10:31	24/12/2020 09:07	24/12/2020 10:31	1,40	1	1,40	CHI
202012137760	FAINA	FC12321457	GOIAS	24/12/2020 09:08	24/12/2020 11:59	24/12/2020 09:08	24/12/2020 11:59	2,85	22	62,62	CHI
202012137909	SAO FRANCISCO DE GOIAS	PG12230708	PETROLINA	24/12/2020 09:09	24/12/2020 13:30	24/12/2020 09:09	24/12/2020 13:30	4,35	12	52,15	CHI
202012137909	PETROLINA DE GOIAS	PG12230708	PETROLINA	24/12/2020 09:09	24/12/2020 13:30	24/12/2020 09:09	24/12/2020 13:30	4,35	6	26,08	CHI
202012137818	MORRINHOS	MR12381164	MORRINHOS	24/12/2020 09:11	24/12/2020 12:41	24/12/2020 09:11	24/12/2020 12:41	3,49	6	20,97	CHI
202012137584	APARECIDA DE GOIANIA	AP21162126	ANHANGUERA	24/12/2020 09:12	24/12/2020 13:48	24/12/2020 09:12	24/12/2020 13:48	4,60	1	4,60	CHI
202012137593	CRISTALINA	KR21270424	CRISTALINA S2	24/12/2020 09:14	24/12/2020 13:57	24/12/2020 09:14	24/12/2020 13:57	4,71	1	4,71	CHI
202012138046	ANICUNS	AC12035306	ANICUNS	24/12/2020 09:20	24/12/2020 12:22	24/12/2020 09:20	24/12/2020 12:22	3,02	19	57,37	CHI
202012137647	CAVALCANTE	CJ12163386	FLORES DE GOIAS	24/12/2020 09:22	24/12/2020 10:59	24/12/2020 09:22	24/12/2020 10:59	1,61	9	14,47	CHI
202012137652	IACIARA	IA12211563	IACIARA S1	24/12/2020 09:23	24/12/2020 14:47	24/12/2020 09:23	24/12/2020 14:47	5,39	9	48,50	CHI
202012137857	PADRE BERNARDO	PB12382215	PADRE BERNARDO	24/12/2020 09:23	24/12/2020 11:27	24/12/2020 09:23	24/12/2020 11:27	2,05	15	30,82	CHI
202012137679	ARAGUAPAZ	AZ12042877	MOZARLANDIA	24/12/2020 09:24	24/12/2020 20:21	24/12/2020 09:24	24/12/2020 20:21	10,96	87	953,45	CHI
202012137679	MOZARLANDIA	AZ12042877	MOZARLANDIA	24/12/2020 09:24	24/12/2020 20:21	24/12/2020 09:24	24/12/2020 20:21	10,96	2	21,92	CHI
202012137669	JUSSARA	JR12076133	BRITANIA	24/12/2020 09:26	24/12/2020 15:00	24/12/2020 09:26	24/12/2020 15:00	5,56	3	16,67	CHI
202012137670	SERRANOPOLIS	DJ12135998	CHAPADAO DO CEU	24/12/2020 09:26	24/12/2020 13:10	24/12/2020 09:26	24/12/2020 13:10	3,72	3	11,17	CHI
202012137910	IVOLANDIA	IV12323743	IPORA	24/12/2020 09:28	24/12/2020 13:35	24/12/2020 09:28	24/12/2020 13:35	4,11	6	24,68	CHI
202012137712	SANTA ISABEL	GE12000139	GOIANESIA S1	24/12/2020 09:29	24/12/2020 15:21	24/12/2020 09:29	24/12/2020 15:21	5,85	14	81,96	CHI
202012137695	VICENTINOPOLIS	JV12062388	GOIATUBA S1	24/12/2020 09:30	24/12/2020 11:42	24/12/2020 09:30	24/12/2020 11:42	2,20	1	2,20	CHI
202012137696	GOIANIA	GN11169552	AEROPORTO S3	24/12/2020 09:30	24/12/2020 11:12	24/12/2020 09:30	24/12/2020 11:12	1,69	39	65,85	CHI
202012137922	MORRINHOS	GT12188828	GOIATUBA S2	24/12/2020 09:31	24/12/2020 12:42	24/12/2020 09:31	24/12/2020 12:42	3,18	8	25,46	CHI
202012138682	ITAPIRAPUA	IU12089737	MATRINCHA	24/12/2020 09:31	24/12/2020 15:48	24/12/2020 09:31	24/12/2020 15:48	6,28	7	43,97	CHI
202012137707	ARAGOIANIA	HD12000185	CEPAIGO S2	24/12/2020 09:32	24/12/2020 19:40	24/12/2020 09:32	24/12/2020 19:40	10,13	5	50,63	CHI
202012137724	ALTO HORIZONTE	AJ12317686	SANTA TEREZINHA	24/12/2020 09:35	24/12/2020 12:02	24/12/2020 09:35	24/12/2020 12:02	2,44	1	2,44	CHI
202012137728	LUZIANIA	LZ12271130	VIANOPOLIS	24/12/2020 09:36	24/12/2020 19:08	24/12/2020 09:36	24/12/2020 19:08	9,52	3	28,57	CHI
202012137735	SIMOLANDIA	SA12096285	IACIARA S2	24/12/2020 09:37	24/12/2020 15:03	24/12/2020 09:37	24/12/2020 15:03	5,42	35	189,62	CHI
202012137739	GAMELEIRA DE GOIAS	SV12272205	DAIA S2	24/12/2020 09:38	24/12/2020 14:13	24/12/2020 09:38	24/12/2020 14:13	4,58	12	54,91	CHI
202012137750	SAO MIGUEL DO ARAGUAIA	SM12384276	SAO MIGUEL DO ARAGUAIA	24/12/2020 09:41	24/12/2020 12:34	24/12/2020 09:41	24/12/2020 12:34	2,88	4	11,52	CHI
202012137962	JATAI	JT12035975	CACHOEIRA ALTA	24/12/2020 09:41	25/12/2020 09:02	24/12/2020 09:41	25/12/2020 09:02	23,33	5	116,67	CHI
202012137807	NOVO BRASIL	NB12099378	JUSSARA	24/12/2020 09:45	24/12/2020 16:39	24/12/2020 09:45	24/12/2020 16:39	6,89	1	6,89	CHI
202012137807	FAZENDA NOVA	NB12099378	JUSSARA	24/12/2020 09:45	24/12/2020 16:39	24/12/2020 09:45	24/12/2020 16:39	6,89	3	20,66	CHI
202012137806	QUIRINOPOLIS	QI12296555	QUIRINOPOLIS	24/12/2020 09:46	24/12/2020 11:38	24/12/2020 09:46	24/12/2020 11:38	1,86	1	1,86	CHI
202012137915	MONTES CLAROS DE GOIAS	ME12140008	IPORA	24/12/2020 09:50	24/12/2020 15:10	24/12/2020 09:50	24/12/2020 15:10	5,33	18	96,00	CHI
202012137971	ARAGUAPAZ	AZ12404546	MOZARLANDIA	24/12/2020 09:51	24/12/2020 15:54	24/12/2020 09:51	24/12/2020 15:54	6,04	7	42,30	CHI
202012137844	BALIZA	BH21064381	BOM JARDIM	24/12/2020 09:53	24/12/2020 16:59	24/12/2020 09:53	24/12/2020 16:59	7,10	1	7,10	CHI

202012137871	IPAMERI	IP12272801	IPAMERI	24/12/2020 09:57	24/12/2020 22:01	24/12/2020 09:57	24/12/2020 22:01	12,07	12	144,80	CHI
202012137897	CAIAPONIA	CP12358788	MONTIVIDIU T	24/12/2020 10:00	24/12/2020 14:42	24/12/2020 10:00	24/12/2020 14:42	4,69	2	9,38	CHI
202012137906	GUARANI DE GOIAS	SD12269338	SAO DOMINGOS	24/12/2020 10:01	24/12/2020 12:26	24/12/2020 10:01	24/12/2020 12:26	2,40	3	7,20	CHI
202012137906	SAO DOMINGOS	SD12269338	SAO DOMINGOS	24/12/2020 10:01	24/12/2020 12:26	24/12/2020 10:01	24/12/2020 12:26	2,40	5	12,00	CHI
202012138059	LEOPOLDO DE BULHOES	03380414	DAIA S2	24/12/2020 10:03	24/12/2020 10:09	24/12/2020 10:03	24/12/2020 10:08	0,08	409	32,27	CHI
202012138059	GAMELEIRA DE GOIAS	03380414	DAIA S2	24/12/2020 10:03	24/12/2020 10:09	24/12/2020 10:03	24/12/2020 10:08	0,08	2	0,16	CHI
202012138059	BONFINOPOLIS	03380414	DAIA S2	24/12/2020 10:03	24/12/2020 10:09	24/12/2020 10:03	24/12/2020 10:08	0,08	52	4,10	CHI
202012138059	GOIANAPOLIS	03380414	DAIA S2	24/12/2020 10:03	24/12/2020 10:09	24/12/2020 10:03	24/12/2020 10:08	0,08	1752	138,21	CHI
202012138059	TEREZOPOLIS DE GOIAS	03380414	DAIA S2	24/12/2020 10:03	24/12/2020 10:09	24/12/2020 10:03	24/12/2020 10:09	0,09	48	4,27	CHI
202012138059	ANAPOLIS	03380414	DAIA S2	24/12/2020 10:03	24/12/2020 10:09	24/12/2020 10:03	24/12/2020 10:09	0,09	9	0,80	CHI
202012138059	GOIANAPOLIS	03380414	DAIA S2	24/12/2020 10:03	24/12/2020 10:09	24/12/2020 10:03	24/12/2020 10:09	0,09	1863	165,60	CHI
202012138059	LEOPOLDO DE BULHOES	03380414	DAIA S2	24/12/2020 10:03	24/12/2020 10:09	24/12/2020 10:03	24/12/2020 10:09	0,09	164	14,58	CHI
202012138059	LEOPOLDO DE BULHOES	03380414	DAIA S2	24/12/2020 10:03	24/12/2020 10:09	24/12/2020 10:03	24/12/2020 10:09	0,09	547	49,53	CHI
202012138059	GOIANAPOLIS	03380414	DAIA S2	24/12/2020 10:03	24/12/2020 10:09	24/12/2020 10:03	24/12/2020 10:09	0,09	1109	100,43	CHI
202012137919	ACREUNA	EU12030223	ACREUNA	24/12/2020 10:04	24/12/2020 12:27	24/12/2020 10:04	24/12/2020 12:27	2,37	3	7,10	CHI
202012137364	ALEXANIA	AX12387698	ALEXANIA	24/12/2020 10:08	24/12/2020 16:00	24/12/2020 10:08	24/12/2020 16:00	5,87	3	17,60	CHI
202012138047	PALMEIRAS DE GOIAS	PL12085231	PALMEIRAS	24/12/2020 10:09	24/12/2020 14:58	24/12/2020 10:09	24/12/2020 14:58	4,81	51	245,23	CHI
202012137979	NIQUELANDIA	TI12237626RE	MINACU	24/12/2020 10:10	24/12/2020 13:30	24/12/2020 10:10	24/12/2020 13:30	3,33	1	3,33	CHI
202012137979	COLINAS DO SUL	TI12237626RE	MINACU	24/12/2020 10:10	24/12/2020 13:30	24/12/2020 10:10	24/12/2020 13:30	3,33	54	179,70	CHI
202012137979	URUACU	TI12237626RE	MINACU	24/12/2020 10:10	24/12/2020 13:30	24/12/2020 10:10	24/12/2020 13:30	3,33	1	3,33	CHI
202012137954	QUIRINOPOLIS	QI12279796RE	QUIRINOPOLIS	24/12/2020 10:11	24/12/2020 22:56	24/12/2020 10:11	24/12/2020 22:56	12,74	13	165,67	CHI
202012138276	CAMPOS VERDES	VD12363564	SANTA TEREZINHA	24/12/2020 10:12	24/12/2020 16:25	24/12/2020 10:12	24/12/2020 16:25	6,21	32	198,67	CHI
202012137972	GOIANIA	15061395	GOIANIA LESTE S1	24/12/2020 10:14	24/12/2020 16:11	24/12/2020 10:14	24/12/2020 16:11	5,95	0	0,00	CHI
202012138103	PIRENOPOLIS	PV12062894	SAO FRANCISCO DE GOIAS	24/12/2020 10:14	24/12/2020 17:53	24/12/2020 10:14	24/12/2020 17:53	7,65	22	168,25	CHI
202012138103	PETROLINA DE GOIAS	PV12062894	SAO FRANCISCO DE GOIAS	24/12/2020 10:14	24/12/2020 17:53	24/12/2020 10:14	24/12/2020 17:53	7,65	3	22,94	CHI
202012137987	MINEIROS	MY21303392	PARQUE DAS EMAS	24/12/2020 10:16	25/12/2020 03:05	24/12/2020 10:16	25/12/2020 03:05	16,82	1	16,82	CHI
202012138079	LEOPOLDO DE BULHOES	LB11116207	DAIA S2	24/12/2020 10:17	24/12/2020 12:21	24/12/2020 10:17	24/12/2020 12:21	2,07	45	92,96	CHI
202012138014	ITUMBIARA	BJ12257011	BOM JESUS DE GOIAS	24/12/2020 10:21	24/12/2020 13:05	24/12/2020 10:21	24/12/2020 13:05	2,72	5	13,60	CHI
202012138216	SAO MIGUEL DO ARAGUAIA	SM12252458	SAO MIGUEL DO ARAGUAIA	24/12/2020 10:23	24/12/2020 13:41	24/12/2020 10:23	24/12/2020 13:41	3,29	5	16,44	CHI
202012138053	VICENTINOPOLIS	VI12218178	VICENTINOPOLIS	24/12/2020 10:27	24/12/2020 13:27	24/12/2020 10:27	24/12/2020 13:27	2,99	5	14,97	CHI
202012138134	ABADIANIA	AA12062592	ANAPOLIS UNIVERSITARIO S1	24/12/2020 10:27	24/12/2020 17:41	24/12/2020 10:27	24/12/2020 17:41	7,22	5	36,10	CHI
202012138062	ISRAELANDIA	IS21188392	IPORA	24/12/2020 10:28	24/12/2020 13:45	24/12/2020 10:28	24/12/2020 13:45	3,28	1	3,28	CHI
202012138083	CIDADE OCIDENTAL	LZ13192006	MARAJOARA	24/12/2020 10:33	24/12/2020 14:05	24/12/2020 10:33	24/12/2020 14:05	3,53	26	91,79	CHI
202012138087	ESTRELA DO NORTE	ET12372080	MARA ROSA	24/12/2020 10:33	24/12/2020 12:32	24/12/2020 10:33	24/12/2020 12:32	1,98	2	3,95	CHI
202012138190	JATAI	JT12109029	JATAI S1	24/12/2020 10:33	24/12/2020 13:37	24/12/2020 10:33	24/12/2020 13:37	3,06	28	85,75	CHI
202012139439	IPAMERI	OZ12137542RE	PIRES DO RIO S2	24/12/2020 10:34	24/12/2020 19:33	24/12/2020 10:34	24/12/2020 19:33	8,97	10	89,73	CHI
202012138105	HIDROLANDIA	HD21035979	ANHANGUERA	24/12/2020 10:35	24/12/2020 14:14	24/12/2020 10:35	24/12/2020 14:14	3,63	1	3,63	CHI
202012138118	GOIANIA	GN21078304	FERROVIARIO S1	24/12/2020 10:39	24/12/2020 12:30	24/12/2020 11:31	24/12/2020 12:30	0,98	1	0,98	CHI
202012138153	JATAI	DP10394739	JATAI S1	24/12/2020 10:45	24/12/2020 19:24	24/12/2020 10:45	24/12/2020 13:22	2,62	6	15,71	CHI
202012138153	PEROLANDIA	DP10394739	JATAI S1	24/12/2020 10:45	24/12/2020 19:24	24/12/2020 10:45	24/12/2020 13:22	2,62	6	15,71	CHI
202012138153	CAIAPONIA	DP10394739	JATAI S1	24/12/2020 10:45	24/12/2020 19:24	24/12/2020 10:45	24/12/2020 15:06	4,36	20	87,12	CHI
202012138153	PEROLANDIA	DP10394739	JATAI S1	24/12/2020 10:45	24/12/2020 19:24	24/12/2020 10:45	24/12/2020 15:06	4,36	3	13,07	CHI
202012138153	JATAI	DP10394739	JATAI S1	24/12/2020 10:45	24/12/2020 19:24	24/12/2020 10:45	24/12/2020 15:06	4,36	176	766,68	CHI
202012138153	JATAI	JT12000230LD	JATAI S1	24/12/2020 10:45	24/12/2020 19:24	24/12/2020 10:45	24/12/2020 19:24	8,65	122	1055,67	CHI
202012138150	MOSSAMEDES	MD12020701	ITABERAI S2	24/12/2020 10:46	24/12/2020 13:33	24/12/2020 10:46	24/12/2020 13:33	2,77	57	157,76	CHI
202012138159	BURITI ALEGRE	BG21282020	ALTO BURITI	24/12/2020 10:48	24/12/2020 12:37	24/12/2020 10:48	24/12/2020 12:37	1,81	1	1,81	CHI
202012138182	NIQUELANDIA	NQ12330279	NIQUELANDIA SUBTRANSMISSAO	24/12/2020 10:53	24/12/2020 17:30	24/12/2020 10:53	24/12/2020 17:30	6,61	4	26,46	CHI
202012138186	MORRINHOS	MR12252186	GOIATUBA S1	24/12/2020 10:53	24/12/2020 16:48	24/12/2020 10:53	24/12/2020 16:48	5,91	3	17,73	CHI
202012138198	RIO VERDE	RV11326781	RIO VERDE S1	24/12/2020 10:56	24/12/2020 16:55	24/12/2020 10:56	24/12/2020 16:55	5,99	131	784,22	CHI
202012139085	CAMPINACU	IH12192447	MINACU	24/12/2020 10:59	24/12/2020 17:38	24/12/2020 10:59	24/12/2020 17:38	6,64	5	33,21	CHI
202012139085	MINACU	IH12192447	MINACU	24/12/2020 10:59	24/12/2020 17:38	24/12/2020 10:59	24/12/2020 17:38	6,64	23	152,78	CHI

202012138214	GOIATUBA	140049551	GOIATUBA S2	24/12/2020 11:00	24/12/2020 14:51	24/12/2020 11:00	24/12/2020 14:51	3,86	1	3,86	CHI
202012138215	GOIAS	GS12307624	GOIAS	24/12/2020 11:00	24/12/2020 12:23	24/12/2020 11:00	24/12/2020 12:23	1,38	2	2,77	CHI
202012138231	PORANGATU	PO12230401	MARA ROSA	24/12/2020 11:01	24/12/2020 15:29	24/12/2020 11:01	24/12/2020 15:29	4,47	5	22,33	CHI
202012138230	CALDAS NOVAS	760224675	SERRA DE CALDAS	24/12/2020 11:04	24/12/2020 18:19	24/12/2020 11:04	24/12/2020 18:19	7,24	1	7,24	CHI
202012138240	JARAGUA	JA21134349	JARAGUA	24/12/2020 11:08	25/12/2020 15:59	24/12/2020 11:08	25/12/2020 15:59	28,84	1	28,84	CHI
202012138249	PORANGATU	PO12282217	NOVO PLANALTO	24/12/2020 11:10	25/12/2020 07:48	24/12/2020 11:10	25/12/2020 07:48	20,63	1	20,63	CHI
202012138250	SILVANIA	SV21161715	DAIA S2	24/12/2020 11:10	24/12/2020 15:30	24/12/2020 11:10	24/12/2020 15:30	4,32	1	4,32	CHI
202012138286	ITAPURANGA	HE12158782	ITAPURANGA	24/12/2020 11:15	24/12/2020 12:54	24/12/2020 11:15	24/12/2020 12:54	1,64	16	26,29	CHI
202012138286	HEITORAI	HE12158782	ITAPURANGA	24/12/2020 11:15	24/12/2020 12:54	24/12/2020 11:15	24/12/2020 12:54	1,64	4	6,57	CHI
202012138334	GOIATUBA	GT12048503	GOIATUBA S2	24/12/2020 11:16	24/12/2020 14:31	24/12/2020 11:16	24/12/2020 14:31	3,24	21	67,99	CHI
202012138301	GAMELEIRA DE GOIAS	SV12116679	DAIA S2	24/12/2020 11:24	24/12/2020 19:29	24/12/2020 11:24	24/12/2020 19:29	8,08	16	129,28	CHI
202012138301	SILVANIA	SV12116679	DAIA S2	24/12/2020 11:24	24/12/2020 19:29	24/12/2020 11:24	24/12/2020 19:29	8,08	6	48,48	CHI
202012138305	SERRANOPOLIS	SX12390576	JATAI S1	24/12/2020 11:25	24/12/2020 22:39	24/12/2020 11:25	24/12/2020 22:39	11,23	10	112,27	CHI
202012138331	NIQUELANDIA	2750102190	URUACU	24/12/2020 11:31	24/12/2020 15:40	24/12/2020 11:31	24/12/2020 15:40	4,14	1	4,14	CHI
202012138654	SAO DOMINGOS	SD12090135	SAO DOMINGOS	24/12/2020 11:32	24/12/2020 15:45	24/12/2020 11:32	24/12/2020 15:45	4,21	83	349,82	CHI
202012138654	DIVINOPOLIS DE GOIAS	SD12090135	SAO DOMINGOS	24/12/2020 11:32	24/12/2020 15:45	24/12/2020 11:32	24/12/2020 15:45	4,21	24	101,15	CHI
202012138353	POSSE	PS12302641	IACIARA S2	24/12/2020 11:37	24/12/2020 17:38	24/12/2020 11:37	24/12/2020 17:38	6,01	2	12,01	CHI
202012138359	GOIANAPOLIS	10017600853	DAIA S2	24/12/2020 11:38	25/12/2020 05:12	24/12/2020 11:38	25/12/2020 05:12	17,57	1	17,57	CHI
202012138366	MOZARLANDIA	NA12084403	MOZARLANDIA	24/12/2020 11:41	25/12/2020 00:30	24/12/2020 11:41	25/12/2020 00:30	12,82	2	25,63	CHI
202012138366	NOVA CRIXAS	NA12084403	MOZARLANDIA	24/12/2020 11:41	25/12/2020 00:30	24/12/2020 11:41	25/12/2020 00:30	12,82	5	64,08	CHI
202012138369	ITUMBIARA	IT12035433	ITUMBIARA VELHA S2	24/12/2020 11:41	24/12/2020 16:51	24/12/2020 11:41	24/12/2020 16:51	5,16	3	15,48	CHI
202012138486	ORIZONA	OZ12032532	PIRES DO RIO S2	24/12/2020 11:48	24/12/2020 23:02	24/12/2020 11:48	24/12/2020 23:02	11,23	7	78,63	CHI
202012138429	CIDADE OCIDENTAL	DH10406855	MARAJOARA	24/12/2020 11:55	24/12/2020 13:39	24/12/2020 11:55	24/12/2020 13:18	1,38	255	353,03	CHI
202012138429	CIDADE OCIDENTAL	DH10406855	MARAJOARA	24/12/2020 11:55	24/12/2020 13:39	24/12/2020 11:55	24/12/2020 13:39	1,74	499	866,87	CHI
202012138454	SERRANOPOLIS	JT10413490	JATAI S1	24/12/2020 11:57	25/12/2020 14:00	24/12/2020 13:33	24/12/2020 14:10	0,62	39	24,17	CHI
202012138454	MINEIROS	JT10413490	CHAPADAO DO CEU	24/12/2020 11:57	25/12/2020 14:00	24/12/2020 13:33	24/12/2020 14:10	0,62	20	12,39	CHI
202012138454	JATAI	JT10413490	JATAI S1	24/12/2020 11:57	25/12/2020 14:00	24/12/2020 13:33	24/12/2020 14:10	0,62	239	148,11	CHI
202012138454	SERRANOPOLIS	JT10413490	CHAPADAO DO CEU	24/12/2020 11:57	25/12/2020 14:00	24/12/2020 13:33	24/12/2020 14:10	0,62	5	3,10	CHI
202012138454	PEROLANDIA	JT10400620	JATAI S1	24/12/2020 11:57	25/12/2020 14:00	24/12/2020 11:57	24/12/2020 14:10	2,21	9	19,93	CHI
202012138454	JATAI	JT10400620	JATAI S1	24/12/2020 11:57	25/12/2020 14:00	24/12/2020 11:57	24/12/2020 14:10	2,21	148	327,78	CHI
202012138454	MINEIROS	JT10400565	CHAPADAO DO CEU	24/12/2020 11:57	25/12/2020 14:00	24/12/2020 15:55	24/12/2020 15:59	0,06	20	1,28	CHI
202012138454	SERRANOPOLIS	JT10400565	CHAPADAO DO CEU	24/12/2020 11:57	25/12/2020 14:00	24/12/2020 15:55	24/12/2020 15:59	0,06	5	0,32	CHI
202012138454	JATAI	JT10400565	JATAI S1	24/12/2020 11:57	25/12/2020 14:00	24/12/2020 15:55	24/12/2020 15:59	0,06	229	14,69	CHI
202012138454	SERRANOPOLIS	JT10400565	JATAI S1	24/12/2020 11:57	25/12/2020 14:00	24/12/2020 15:55	24/12/2020 15:59	0,06	6	0,38	CHI
202012138454	PEROLANDIA	JT10400565	JATAI S1	24/12/2020 11:57	25/12/2020 14:00	24/12/2020 15:55	24/12/2020 15:59	0,06	9	0,58	CHI
202012138454	SERRANOPOLIS	JT10400620	CHAPADAO DO CEU	24/12/2020 11:57	25/12/2020 14:00	25/12/2020 13:37	25/12/2020 13:44	0,11	5	0,54	CHI
202012138454	MINEIROS	JT10400620	CHAPADAO DO CEU	24/12/2020 11:57	25/12/2020 14:00	25/12/2020 13:37	25/12/2020 13:44	0,11	20	2,18	CHI
202012138454	JATAI	JT10400620	JATAI S1	24/12/2020 11:57	25/12/2020 14:00	25/12/2020 13:37	25/12/2020 13:44	0,11	81	8,82	CHI
202012138454	SERRANOPOLIS	JT10400620	JATAI S1	24/12/2020 11:57	25/12/2020 14:00	25/12/2020 13:37	25/12/2020 13:44	0,11	6	0,65	CHI
202012138454	JATAI	JT10400565	JATAI S1	24/12/2020 11:57	25/12/2020 14:00	25/12/2020 13:39	25/12/2020 13:44	0,08	39	3,08	CHI
202012138454	JATAI	JT13068116	JATAI S1	24/12/2020 11:57	25/12/2020 14:00	24/12/2020 14:16	25/12/2020 13:45	23,48	4	93,91	CHI
202012138454	JATAI	JT13068116	JATAI S1	24/12/2020 11:57	25/12/2020 14:00	24/12/2020 18:07	25/12/2020 13:45	19,63	6	117,80	CHI
202012138454	SERRANOPOLIS	JT13337013	JATAI S1	24/12/2020 11:57	25/12/2020 14:00	25/12/2020 13:50	25/12/2020 14:00	0,16	10	1,63	CHI
202012138454	JATAI	JT13337013	JATAI S1	24/12/2020 11:57	25/12/2020 14:00	25/12/2020 13:50	25/12/2020 14:00	0,16	145	23,64	CHI
202012138439	CORREGO DO OURO	CO12003798	SAO LUIZ DOS MONTES BELOS	24/12/2020 11:59	24/12/2020 13:35	24/12/2020 11:59	24/12/2020 13:35	1,60	59	94,38	CHI
202012139246	CORUMBAIBA	CI21392099	VILA CORUMBA	24/12/2020 12:00	24/12/2020 16:59	24/12/2020 12:00	24/12/2020 16:59	4,98	1	4,98	CHI
202012142263	SERRANOPOLIS	SX12238882LD	JATAI S1	24/12/2020 12:01	25/12/2020 11:14	24/12/2020 12:01	25/12/2020 11:14	23,20	4	92,82	CHI
202012139691	MARA ROSA	VD12201669	SANTA TEREZINHA	24/12/2020 12:03	24/12/2020 20:27	24/12/2020 12:03	24/12/2020 20:27	8,39	2	16,77	CHI
202012138457	CAIAPONIA	10003335966	CAIAPONIA	24/12/2020 12:04	24/12/2020 17:31	24/12/2020 12:04	24/12/2020 17:31	5,45	1	5,45	CHI
202012138492	JATAI	JT12238549	JATAI S1	24/12/2020 12:10	24/12/2020 18:43	24/12/2020 12:10	24/12/2020 18:43	6,54	6	39,23	CHI
202012138476	ANAPOLIS	20957592	ANAPOLIS UNIVERSITARIO S2	24/12/2020 12:11	24/12/2020 18:10	24/12/2020 12:11	24/12/2020 18:10	5,97	1	5,97	CHI

202012138477	ANHANGUERA	AH11000072	CATALAO S1	24/12/2020 12:11	24/12/2020 18:06	24/12/2020 17:30	24/12/2020 18:06	0,61	103	62,69	CHI
202012138604	SAO DOMINGOS	SD11046237	SAO DOMINGOS	24/12/2020 12:12	24/12/2020 13:54	24/12/2020 12:12	24/12/2020 13:54	1,70	283	480,24	CHI
202012138663	RIO VERDE	RV12301462	ACREUNA	24/12/2020 12:14	24/12/2020 14:00	24/12/2020 12:14	24/12/2020 14:00	1,76	16	28,18	CHI
202012138663	SANTO ANTONIO DA BARRA	RV12301462	ACREUNA	24/12/2020 12:14	24/12/2020 14:00	24/12/2020 12:14	24/12/2020 14:00	1,76	1	1,76	CHI
202012139799	NOVO BRASIL	FN12250941	JUSSARA	24/12/2020 12:15	24/12/2020 21:15	24/12/2020 12:15	24/12/2020 21:15	8,99	2	17,98	CHI
202012139799	FAZENDA NOVA	FN12250941	JUSSARA	24/12/2020 12:15	24/12/2020 21:15	24/12/2020 12:15	24/12/2020 21:15	8,99	72	647,40	CHI
202012138507	SERRANOPOLIS	DJ12164061	CHAPADAO DO CEU	24/12/2020 12:19	24/12/2020 15:00	24/12/2020 12:19	24/12/2020 15:00	2,67	2	5,34	CHI
202012138508	SERRANOPOLIS	DJ12164060	CHAPADAO DO CEU	24/12/2020 12:19	24/12/2020 15:18	24/12/2020 12:19	24/12/2020 15:18	2,98	7	20,83	CHI
202012138509	NOVO BRASIL	1460005391	JUSSARA	24/12/2020 12:20	24/12/2020 14:50	24/12/2020 12:20	24/12/2020 14:50	2,51	1	2,51	CHI
202012138516	PIRENOPOLIS	CB12215044	CORUMBA	24/12/2020 12:20	24/12/2020 16:12	24/12/2020 12:20	24/12/2020 16:12	3,86	2	7,73	CHI
202012138516	CORUMBA DE GOIAS	CB12215044	CORUMBA	24/12/2020 12:20	24/12/2020 16:12	24/12/2020 12:20	24/12/2020 16:12	3,86	23	88,85	CHI
202012139487	APORE	AE12061471	ITAJA S1	24/12/2020 12:22	25/12/2020 11:45	24/12/2020 12:22	25/12/2020 11:45	23,38	7	163,63	CHI
202012139249	NOVA AURORA	CI12000451	VILA CORUMBA	24/12/2020 12:24	24/12/2020 16:05	24/12/2020 12:24	24/12/2020 16:05	3,68	7	25,76	CHI
202012139249	CORUMBAIBA	CI12000451	VILA CORUMBA	24/12/2020 12:24	24/12/2020 16:05	24/12/2020 12:24	24/12/2020 16:05	3,68	8	29,44	CHI
202012138538	URUTAI	UT12300798	URUTAI	24/12/2020 12:25	24/12/2020 17:59	24/12/2020 12:25	24/12/2020 17:59	5,56	22	122,42	CHI
202012138538	PIRES DO RIO	UT12300798	URUTAI	24/12/2020 12:25	24/12/2020 17:59	24/12/2020 12:25	24/12/2020 17:59	5,56	2	11,13	CHI
202012138545	CRIXAS	CX12394923	RUBIATABA	24/12/2020 12:26	24/12/2020 15:10	24/12/2020 12:26	24/12/2020 15:10	2,74	17	46,57	CHI
202012141614	NIQUELANDIA	NQ12171083	BARRO ALTO	24/12/2020 12:27	25/12/2020 17:58	24/12/2020 12:27	25/12/2020 17:58	29,50	9	265,51	CHI
202012138550	VALPARAISO DE GOIAS	VA11060576	MARAJOARA	24/12/2020 12:28	24/12/2020 13:50	24/12/2020 12:28	24/12/2020 13:50	1,36	21	28,54	CHI
202012138553	GOIANDIRA	GD12063995	CATALAO S2	24/12/2020 12:28	24/12/2020 16:51	24/12/2020 12:28	24/12/2020 16:51	4,37	3	13,10	CHI
202012138556	VALPARAISO DE GOIAS	2860224150	MARAJOARA	24/12/2020 12:29	24/12/2020 18:45	24/12/2020 12:29	24/12/2020 18:45	6,27	1	6,27	CHI
2020122400064	NOVA CRIXAS	SM13086464	SAO MIGUEL DO ARAGUAIA	24/12/2020 12:30	24/12/2020 13:16	24/12/2020 13:04	24/12/2020 13:13	0,16	1	0,16	CHI
2020122400064	SAO MIGUEL DO ARAGUAIA	SM13086464	SAO MIGUEL DO ARAGUAIA	24/12/2020 12:30	24/12/2020 13:16	24/12/2020 13:04	24/12/2020 13:13	0,16	1267	204,13	CHI
2020122400064	CACU	01710424	SAO MIGUEL DO ARAGUAIA	24/12/2020 12:30	24/12/2020 13:16	24/12/2020 13:04	24/12/2020 13:16	0,20	1	0,20	CHI
2020122400064	SAO MIGUEL DO ARAGUAIA	01710424	SAO MIGUEL DO ARAGUAIA	24/12/2020 12:30	24/12/2020 13:16	24/12/2020 13:04	24/12/2020 13:16	0,20	632	127,28	CHI
2020122400064	NOVO PLANALTO	01710424	SAO MIGUEL DO ARAGUAIA	24/12/2020 12:30	24/12/2020 13:16	24/12/2020 13:04	24/12/2020 13:16	0,20	354	71,29	CHI
2020122400064	AMARALINA	01710424	SAO MIGUEL DO ARAGUAIA	24/12/2020 12:30	24/12/2020 13:16	24/12/2020 13:04	24/12/2020 13:16	0,20	224	45,11	CHI
2020122400064	BONOPOLIS	01710424	SAO MIGUEL DO ARAGUAIA	24/12/2020 12:30	24/12/2020 13:16	24/12/2020 13:04	24/12/2020 13:16	0,20	23	4,63	CHI
2020122400064	BONOPOLIS	01710424	SAO MIGUEL DO ARAGUAIA	24/12/2020 12:30	24/12/2020 13:16	24/12/2020 13:04	24/12/2020 13:16	0,20	791	159,30	CHI
2020122400064	SAO MIGUEL DO ARAGUAIA	01710214	SAO MIGUEL DO ARAGUAIA	24/12/2020 12:30	24/12/2020 13:16	24/12/2020 13:04	24/12/2020 13:16	0,21	4167	862,34	CHI
2020122400064	SAO MIGUEL DO ARAGUAIA	01710224	SAO MIGUEL DO ARAGUAIA	24/12/2020 12:30	24/12/2020 13:16	24/12/2020 13:04	24/12/2020 13:16	0,21	5018	1060,75	CHI
2020122400064	BONOPOLIS	01710224	SAO MIGUEL DO ARAGUAIA	24/12/2020 12:30	24/12/2020 13:16	24/12/2020 13:04	24/12/2020 13:16	0,21	105	22,20	CHI
202012138606	MARA ROSA	MQ12287615	MARA ROSA	24/12/2020 12:32	24/12/2020 16:20	24/12/2020 12:32	24/12/2020 16:20	3,80	4	15,22	CHI
202012138710	CAMPINACU	UC12197189	PORANGATU	24/12/2020 12:33	24/12/2020 18:51	24/12/2020 12:33	24/12/2020 18:51	6,29	68	427,97	CHI
202012138629	ITAPACI	02600424	ITAPACI	24/12/2020 12:38	25/12/2020 17:01	24/12/2020 12:38	24/12/2020 13:55	1,29	17	21,94	CHI
202012138629	ITAPACI	02600424	ITAPACI	24/12/2020 12:38	25/12/2020 17:01	24/12/2020 12:38	24/12/2020 15:44	3,11	16	49,73	CHI
202012138629	SAO LUIZ DO NORTE	02600424	ITAPACI	24/12/2020 12:38	25/12/2020 17:01	24/12/2020 12:38	24/12/2020 15:44	3,11	8	24,86	CHI
202012138629	PILAR DE GOIAS	02600424	ITAPACI	24/12/2020 12:38	25/12/2020 17:01	24/12/2020 12:38	24/12/2020 15:44	3,11	3	9,32	CHI
202012138629	ITAPACI	02600424	ITAPACI	24/12/2020 12:38	25/12/2020 17:01	24/12/2020 12:38	25/12/2020 16:38	28,01	26	728,20	CHI
202012138629	ITAPACI	IW13213208	ITAPACI	24/12/2020 12:38	25/12/2020 17:01	25/12/2020 11:18	25/12/2020 16:38	5,34	17	90,83	CHI
202012138629	PILAR DE GOIAS	IW13097491	ITAPACI	24/12/2020 12:38	25/12/2020 17:01	25/12/2020 16:45	25/12/2020 16:54	0,15	3	0,46	CHI
202012138629	ITAPACI	IW13097491	ITAPACI	24/12/2020 12:38	25/12/2020 17:01	25/12/2020 16:45	25/12/2020 16:54	0,15	16	2,43	CHI
202012138629	SAO LUIZ DO NORTE	IW13097491	ITAPACI	24/12/2020 12:38	25/12/2020 17:01	25/12/2020 16:45	25/12/2020 16:54	0,15	8	1,21	CHI
202012138629	SANTA ISABEL	04640414	ITAPACI	24/12/2020 12:38	25/12/2020 17:01	25/12/2020 16:57	25/12/2020 17:01	0,07	5	0,35	CHI
202012138629	GOIANESIA	04640414	ITAPACI	24/12/2020 12:38	25/12/2020 17:01	25/12/2020 16:57	25/12/2020 17:01	0,07	12	0,84	CHI
202012138629	NOVA GLORIA	04640414	ITAPACI	24/12/2020 12:38	25/12/2020 17:01	25/12/2020 16:57	25/12/2020 17:01	0,07	1	0,07	CHI
202012138629	HIDROLINA	04640414	ITAPACI	24/12/2020 12:38	25/12/2020 17:01	25/12/2020 16:57	25/12/2020 17:01	0,07	165	11,60	CHI
202012138629	SAO LUIZ DO NORTE	04640414	ITAPACI	24/12/2020 12:38	25/12/2020 17:01	25/12/2020 16:57	25/12/2020 17:01	0,07	2193	154,12	CHI
202012138629	ITAPACI	04640414	ITAPACI	24/12/2020 12:38	25/12/2020 17:01	25/12/2020 16:57	25/12/2020 17:01	0,07	3	0,21	CHI
202012139380	ALVORADA DO NORTE	AQ12347087	IACIARA S2	24/12/2020 12:39	24/12/2020 17:57	24/12/2020 12:39	24/12/2020 17:57	5,28	4	21,14	CHI
202012139792	CABECEIRAS	CW12342434	ITUIQUIRA	24/12/2020 12:41	25/12/2020 07:26	24/12/2020 12:41	25/12/2020 07:26	18,75	5	93,75	CHI

202012141815	JATAI	JT12303523	JATAI S1	24/12/2020 12:43	24/12/2020 23:17	24/12/2020 12:43	24/12/2020 23:17	10,57	14	147,93	CHI
202012138638	HIDROLANDIA	HD12000067	INDEPENDENCIA S1	24/12/2020 12:46	24/12/2020 18:05	24/12/2020 12:46	24/12/2020 17:00	4,23	11	46,52	CHI
202012138638	ARAGOIANIA	HD12000067	INDEPENDENCIA S1	24/12/2020 12:46	24/12/2020 18:05	24/12/2020 12:46	24/12/2020 17:00	4,23	5	21,14	CHI
202012138638	HIDROLANDIA	HD12000067	INDEPENDENCIA S1	24/12/2020 12:46	24/12/2020 18:05	24/12/2020 17:55	24/12/2020 18:05	0,18	11	1,94	CHI
202012138638	ARAGOIANIA	HD12000067	INDEPENDENCIA S1	24/12/2020 12:46	24/12/2020 18:05	24/12/2020 17:55	24/12/2020 18:05	0,18	5	0,88	CHI
202012139464	PEROLANDIA	DP12209129	JATAI S1	24/12/2020 12:50	24/12/2020 18:43	24/12/2020 12:50	24/12/2020 18:43	5,87	8	46,97	CHI
202012138907	MINACU	IH12088797	MINACU	24/12/2020 12:51	24/12/2020 14:57	24/12/2020 12:51	24/12/2020 14:57	2,09	179	374,91	CHI
202012138984	GOIATUBA	GT12190955	GOIATUBA S1	24/12/2020 12:51	24/12/2020 14:58	24/12/2020 12:51	24/12/2020 14:58	2,10	9	18,93	CHI
202012138673	CALDAS NOVAS	10004185976	SERRA DE CALDAS	24/12/2020 12:54	24/12/2020 23:01	24/12/2020 12:54	24/12/2020 23:01	10,11	1	10,11	CHI
202012138676	SANTA RITA DO ARAGUAIA	SU12301950RE	SANTA RITA DO ARAGUAIA	24/12/2020 12:55	25/12/2020 09:10	24/12/2020 12:55	24/12/2020 22:17	9,37	9	84,35	CHI
202012138676	SANTA RITA DO ARAGUAIA	SU12301950RE	SANTA RITA DO ARAGUAIA	24/12/2020 12:55	25/12/2020 09:10	24/12/2020 12:55	24/12/2020 23:17	10,36	7	72,51	CHI
202012138676	BURITINOPOLIS	SU12301950RE	SANTA RITA DO ARAGUAIA	24/12/2020 12:55	25/12/2020 09:10	24/12/2020 12:55	24/12/2020 23:17	10,36	1	10,36	CHI
202012138676	SANTA RITA DO ARAGUAIA	SU12301950RE	SANTA RITA DO ARAGUAIA	24/12/2020 12:55	25/12/2020 09:10	24/12/2020 12:55	25/12/2020 00:08	11,21	5	56,05	CHI
202012138676	SANTA RITA DO ARAGUAIA	SU12301950RE	SANTA RITA DO ARAGUAIA	24/12/2020 12:55	25/12/2020 09:10	24/12/2020 12:55	25/12/2020 09:10	20,25	1	20,25	CHI
202012138762	TURVELANDIA	TD12025737	RIO DOS BOIS	24/12/2020 12:58	24/12/2020 18:55	24/12/2020 12:58	24/12/2020 18:55	5,93	66	391,66	CHI
202012138762	SANTA HELENA DE GOIAS	TD12025737	RIO DOS BOIS	24/12/2020 12:58	24/12/2020 18:55	24/12/2020 12:58	24/12/2020 18:55	5,93	18	106,82	CHI
202012138762	ACREUNA	TD12025737	RIO DOS BOIS	24/12/2020 12:58	24/12/2020 18:55	24/12/2020 12:58	24/12/2020 18:55	5,93	26	154,29	CHI
202012138706	ITAPIRAPUA	IU12018810	MATRINCHA	24/12/2020 13:02	24/12/2020 15:31	24/12/2020 13:02	24/12/2020 15:31	2,47	27	66,67	CHI
202012138797	HIDROLINA	SZ12262852	ITAPACI	24/12/2020 13:02	24/12/2020 17:22	24/12/2020 13:02	24/12/2020 17:22	4,33	7	30,29	CHI
202012138708	RIO VERDE	RV21284344	CABRIUVA S2	24/12/2020 13:03	24/12/2020 21:17	24/12/2020 13:03	24/12/2020 21:17	8,23	2	16,46	CHI
202012138712	SANTA TEREZA DE GOIAS	SE12018896	MARA ROSA	24/12/2020 13:03	24/12/2020 17:26	24/12/2020 13:03	24/12/2020 17:26	4,38	1	4,38	CHI
202012138725	NIQUELANDIA	NQ12290033	NIQUELANDIA SUBTRANSMISSAO	24/12/2020 13:07	24/12/2020 15:32	24/12/2020 13:07	24/12/2020 15:32	2,41	8	19,29	CHI
202012138734	GOIATUBA	GT12421980	GOIATUBA S2	24/12/2020 13:08	24/12/2020 16:19	24/12/2020 13:08	24/12/2020 16:19	3,17	5	15,85	CHI
202012138754	CRISTALINA	KR12261732	CRISTALINA S2	24/12/2020 13:08	24/12/2020 14:40	24/12/2020 13:08	24/12/2020 14:40	1,53	17	26,04	CHI
202012140943	ITAPIRAPUA	IU12018852	MATRINCHA	24/12/2020 13:08	25/12/2020 04:16	24/12/2020 13:08	25/12/2020 04:16	15,13	36	544,66	CHI
202012139070	NIQUELANDIA	NQ12222634	NIQUELANDIA SUBTRANSMISSAO	24/12/2020 13:12	24/12/2020 20:46	24/12/2020 13:12	24/12/2020 20:46	7,56	59	445,86	CHI
202012138758	GOIANDIRA	GD12000006	CATALAO S1	24/12/2020 13:13	24/12/2020 14:52	24/12/2020 14:27	24/12/2020 14:47	0,33	261	87,29	CHI
202012138758	GOIANDIRA	GD11104314	CATALAO S1	24/12/2020 13:13	24/12/2020 14:52	24/12/2020 13:13	24/12/2020 14:52	1,65	59	97,55	CHI
202012138765	APORE	AE12296415	ITAJA S1	24/12/2020 13:14	24/12/2020 19:07	24/12/2020 13:14	24/12/2020 19:07	5,87	4	23,48	CHI
202012138781	PLANALTINA	PI12322789	PLANALTINA	24/12/2020 13:17	25/12/2020 13:35	24/12/2020 13:17	24/12/2020 17:05	3,80	37	140,58	CHI
202012138781	PLANALTINA	PI12322789	PLANALTINA	24/12/2020 13:17	25/12/2020 13:35	24/12/2020 13:17	25/12/2020 13:35	24,30	1	24,30	CHI
202012138781	PLANALTINA	PI12322789	PLANALTINA	24/12/2020 13:17	25/12/2020 13:35	24/12/2020 17:12	25/12/2020 13:35	20,38	37	754,19	CHI
202012138827	PALMEIRAS DE GOIAS	PL12000095	PALMEIRAS	24/12/2020 13:18	24/12/2020 16:13	24/12/2020 13:18	24/12/2020 16:13	2,91	12	34,91	CHI
202012138898	PIRACANJUBA	PJ12249833	PIRACANJUBA	24/12/2020 13:18	24/12/2020 15:38	24/12/2020 13:18	24/12/2020 15:38	2,33	83	193,37	CHI
202012138639	CORUMBAIBA	CI21180477	VILA CORUMBA	24/12/2020 13:19	24/12/2020 15:32	24/12/2020 13:19	24/12/2020 15:32	2,21	1	2,21	CHI
202012138986	HIDROLANDIA	BV12117089	BELA VISTA S1	24/12/2020 13:20	24/12/2020 15:22	24/12/2020 13:20	24/12/2020 15:22	2,02	4	8,08	CHI
202012138804	CACU	CC12000121RE	CACHOEIRA ALTA	24/12/2020 13:22	24/12/2020 20:22	24/12/2020 13:22	24/12/2020 20:22	7,00	21	146,92	CHI
202012138809	BRITANIA	BT12083788	BRITANIA	24/12/2020 13:23	25/12/2020 11:21	24/12/2020 13:23	25/12/2020 07:44	18,35	1	18,35	CHI
202012138809	BRITANIA	BT12083788	BRITANIA	24/12/2020 13:23	25/12/2020 11:21	25/12/2020 07:48	25/12/2020 11:21	3,55	1	3,55	CHI
202012138812	PARAUNA	PU12246343	PARAUNA	24/12/2020 13:25	24/12/2020 17:23	24/12/2020 13:25	24/12/2020 17:23	3,96	1	3,96	CHI
202012139112	PORANGATU	BX12292422	SAO MIGUEL DO ARAGUAIA	24/12/2020 13:29	24/12/2020 16:28	24/12/2020 13:29	24/12/2020 16:28	2,97	1	2,97	CHI
202012139112	BONOPOLIS	BX12292422	SAO MIGUEL DO ARAGUAIA	24/12/2020 13:29	24/12/2020 16:28	24/12/2020 13:29	24/12/2020 16:28	2,97	32	95,14	CHI
202012138834	GUARANI DE GOIAS	SD12192246	SAO DOMINGOS	24/12/2020 13:31	24/12/2020 15:59	24/12/2020 13:31	24/12/2020 15:59	2,46	3	7,39	CHI
202012138834	SAO DOMINGOS	SD12192246	SAO DOMINGOS	24/12/2020 13:31	24/12/2020 15:59	24/12/2020 13:31	24/12/2020 15:59	2,46	12	29,57	CHI
202012139023	ITAPIRAPUA	IU12018834	MATRINCHA	24/12/2020 13:32	25/12/2020 03:05	24/12/2020 13:32	25/12/2020 03:05	13,55	9	121,92	CHI
202012138843	NOVO BRASIL	NB12378819	JUSSARA	24/12/2020 13:33	24/12/2020 17:02	24/12/2020 13:33	24/12/2020 17:02	3,48	4	13,90	CHI
202012139206	JUSSARA	NB12396253	JUSSARA	24/12/2020 13:33	25/12/2020 08:26	24/12/2020 13:33	25/12/2020 08:26	18,87	1	18,87	CHI
202012139206	FAZENDA NOVA	NB12396253	JUSSARA	24/12/2020 13:33	25/12/2020 08:26	24/12/2020 13:33	25/12/2020 08:26	18,87	13	245,36	CHI
202012138846	QUIRINOPOLIS	QI32255692	QUIRINOPOLIS	24/12/2020 13:34	24/12/2020 15:59	24/12/2020 13:34	24/12/2020 15:59	2,41	11	26,50	CHI
202012138870	RIO VERDE	MV12260996	MONTIVIDIU T	24/12/2020 13:39	24/12/2020 17:27	24/12/2020 13:39	24/12/2020 17:27	3,79	7	26,54	CHI
202012138871	SANTA TEREZINHA DE GOIAS	SG12252872	SANTA TEREZINHA	24/12/2020 13:39	24/12/2020 16:47	24/12/2020 13:39	24/12/2020 16:47	3,12	1	3,12	CHI



202012138954	GOIANIA	GN12000200	GOIANIA LESTE S1	24/12/2020 13:40	24/12/2020 15:15	24/12/2020 13:40	24/12/2020 15:15	1,58	98	154,62	CHI
202012139069	PEROLANDIA	DP12260367	JATAI S1	24/12/2020 13:45	25/12/2020 08:53	24/12/2020 13:45	25/12/2020 08:53	19,12	6	114,72	CHI
202012138897	ABADIANIA	AA12388792	DAIA S2	24/12/2020 13:47	24/12/2020 19:10	24/12/2020 13:47	24/12/2020 19:10	5,37	2	10,75	CHI
202012138901	MAURILANDIA	CL12306027	RIO DOS BOIS	24/12/2020 13:48	24/12/2020 18:55	24/12/2020 13:48	24/12/2020 18:55	5,11	5	25,54	CHI
202012138901	PORTEIRAO	CL12306027	RIO DOS BOIS	24/12/2020 13:48	24/12/2020 18:55	24/12/2020 13:48	24/12/2020 18:55	5,11	3	15,33	CHI
202012138913	COLINAS DO SUL	TI12212411LD	MINACU	24/12/2020 13:54	24/12/2020 17:20	24/12/2020 13:54	24/12/2020 17:20	3,42	24	82,19	CHI
202012138913	CAVALCANTE	TI12212411LD	MINACU	24/12/2020 13:54	24/12/2020 17:20	24/12/2020 13:54	24/12/2020 17:20	3,42	65	222,59	CHI
202012138945	GOIAS	GS12061668	ITABERAI S1	24/12/2020 13:55	24/12/2020 18:08	24/12/2020 13:55	24/12/2020 18:08	4,21	16	67,36	CHI
202012139014	JATAI	JT12109029	JATAI S1	24/12/2020 13:55	24/12/2020 18:40	24/12/2020 13:55	24/12/2020 18:40	4,74	28	132,67	CHI
202012138922	GOIAS	GS12076721	GOIAS	24/12/2020 13:56	24/12/2020 16:05	24/12/2020 13:56	24/12/2020 16:05	2,14	23	49,32	CHI
202012138929	URUACU	UR12339123	MARA ROSA	24/12/2020 13:59	24/12/2020 17:37	24/12/2020 13:59	24/12/2020 17:37	3,63	1	3,63	CHI
202012139025	PANAMA	GT12000140	GOIATUBA S1	24/12/2020 13:59	24/12/2020 15:17	24/12/2020 13:59	24/12/2020 15:17	1,29	4	5,15	CHI
202012138936	PROFESSOR JAMIL SAFADY	180011390	ROCHEDO	24/12/2020 14:00	24/12/2020 19:55	24/12/2020 14:00	24/12/2020 19:55	5,91	1	5,91	CHI
202012138949	SAO FRANCISCO DE GOIAS	7311818	SAO FRANCISCO DE GOIAS	24/12/2020 14:03	24/12/2020 17:00	24/12/2020 14:03	24/12/2020 17:00	2,94	2	5,87	CHI
202012138962	ALTO PARAISO DE GOIAS	BF12224063	SAO JOAO D ALIANCA	24/12/2020 14:08	24/12/2020 17:03	24/12/2020 14:08	24/12/2020 17:03	2,90	1	2,90	CHI
202012138967	CALDAS NOVAS	760331935	SERRA DE CALDAS	24/12/2020 14:10	24/12/2020 20:50	24/12/2020 14:10	24/12/2020 20:50	6,67	1	6,67	CHI
202012138969	CAIAPONIA	CP12381058	CAIAPONIA	24/12/2020 14:10	24/12/2020 17:25	24/12/2020 14:10	24/12/2020 17:25	3,24	2	6,47	CHI
202012139811	JATAI	JT21106059	JATAI S1	24/12/2020 14:10	25/12/2020 14:20	24/12/2020 14:10	25/12/2020 14:20	24,17	1	24,17	CHI
202012138971	MONTES CLAROS DE GOIAS	ME12050933	IPORA	24/12/2020 14:11	24/12/2020 23:06	24/12/2020 14:11	24/12/2020 23:06	8,91	7	62,36	CHI
202012138972	CACU	CC21214267	CACHOEIRA ALTA	24/12/2020 14:11	24/12/2020 23:41	24/12/2020 14:11	24/12/2020 23:41	9,50	1	9,50	CHI
202012139396	PONTALINA	MI12394189	PONTALINA	24/12/2020 14:11	24/12/2020 17:58	24/12/2020 14:11	24/12/2020 17:58	3,77	3	11,32	CHI
202012139396	MAIRIPOTABA	MI12394189	PONTALINA	24/12/2020 14:11	24/12/2020 17:58	24/12/2020 14:11	24/12/2020 17:58	3,77	1	3,77	CHI
202012138977	LUZANIA	LZ11405491	RIO VERMELHO	24/12/2020 14:12	24/12/2020 15:18	24/12/2020 14:12	24/12/2020 15:18	1,09	9	9,82	CHI
202012138980	GOUVELANDIA	GB12306195	QUIRINOPOLIS	24/12/2020 14:13	24/12/2020 20:01	24/12/2020 14:13	24/12/2020 20:01	5,79	3	17,36	CHI
202012138997	IACIARA	IA18442679TS	IACIARA S1	24/12/2020 14:19	24/12/2020 15:46	24/12/2020 14:19	24/12/2020 15:46	1,45	36	52,17	CHI
202012138999	SAO JOAO D ALIANCA	JL12383335	SAO JOAO D ALIANCA	24/12/2020 14:19	24/12/2020 17:05	24/12/2020 14:19	24/12/2020 17:05	2,75	11	30,30	CHI
2020122400079	ALVORADA DO NORTE	00010414	IACIARA S2	24/12/2020 14:20	24/12/2020 14:24	24/12/2020 14:20	24/12/2020 14:24	0,07	291	19,40	CHI
2020122400079	FLORES DE GOIAS	00010414	IACIARA S2	24/12/2020 14:20	24/12/2020 14:24	24/12/2020 14:20	24/12/2020 14:24	0,07	41	2,73	CHI
2020122400079	SITIO D ABADIA	00010414	IACIARA S2	24/12/2020 14:20	24/12/2020 14:24	24/12/2020 14:20	24/12/2020 14:24	0,07	27	1,80	CHI
2020122400079	IACIARA	00010414	IACIARA S2	24/12/2020 14:20	24/12/2020 14:24	24/12/2020 14:20	24/12/2020 14:24	0,07	1	0,07	CHI
2020122400079	SIMOLANDIA	00010414	IACIARA S2	24/12/2020 14:20	24/12/2020 14:24	24/12/2020 14:20	24/12/2020 14:24	0,07	1	0,07	CHI
202012139109	SILVANIA	SV12048117	VIANOPOLIS	24/12/2020 14:21	25/12/2020 10:37	24/12/2020 14:21	25/12/2020 10:37	20,27	14	283,75	CHI
202012139109	SILVANIA	SV12048117	VIANOPOLIS	24/12/2020 14:21	25/12/2020 10:37	25/12/2020 08:13	25/12/2020 10:37	2,40	9	21,61	CHI
202012139028	NOVA VENEZA	300017935	INHUMAS S1	24/12/2020 14:27	24/12/2020 22:19	24/12/2020 14:27	24/12/2020 22:19	7,86	1	7,86	CHI
202012139031	PONTALINA	PK12293408	VICENTINOPOLIS	24/12/2020 14:28	24/12/2020 20:32	24/12/2020 14:28	24/12/2020 20:32	6,06	3	18,18	CHI
202012139075	MORRINHOS	GT12273783	GOIATUBA S2	24/12/2020 14:28	24/12/2020 16:19	24/12/2020 14:28	24/12/2020 16:19	1,85	3	5,54	CHI
202012139075	GOIATUBA	GT12273783	GOIATUBA S2	24/12/2020 14:28	24/12/2020 16:19	24/12/2020 14:28	24/12/2020 16:19	1,85	53	97,86	CHI
202012139039	PIRACANJUBA	PJ12162667	PIRACANJUBA	24/12/2020 14:30	24/12/2020 17:17	24/12/2020 14:30	24/12/2020 17:17	2,79	2	5,58	CHI
202012139044	MORRO AGUDO DE GOIAS	MS12136795	ITAPURANGA	24/12/2020 14:32	24/12/2020 17:00	24/12/2020 14:32	24/12/2020 17:00	2,46	37	91,03	CHI
202012139854	MARA ROSA	MQ12380741	SANTA TEREZINHA	24/12/2020 14:32	25/12/2020 09:54	24/12/2020 14:32	25/12/2020 09:54	19,36	11	212,99	CHI
202012139045	AGUA FRIA DE GOIAS	TL12337496	SAO JOAO D ALIANCA	24/12/2020 14:33	24/12/2020 17:31	24/12/2020 14:33	24/12/2020 17:31	2,97	4	11,86	CHI
202012139061	FLORES DE GOIAS	FB12180707	FLORES DE GOIAS	24/12/2020 14:39	24/12/2020 22:58	24/12/2020 14:39	24/12/2020 22:58	8,32	1	8,32	CHI
202012139063	NOVO BRASIL	1460002950	JUSSARA	24/12/2020 14:39	24/12/2020 16:00	24/12/2020 14:39	24/12/2020 16:00	1,35	1	1,35	CHI
202012139072	ACREUNA	EU12000002	ACREUNA	24/12/2020 14:42	24/12/2020 18:20	24/12/2020 14:42	24/12/2020 18:20	3,64	7	25,45	CHI
202012139225	SERRANOPOLIS	SX12166009	JATAI S1	24/12/2020 14:44	25/12/2020 13:49	24/12/2020 14:44	25/12/2020 13:49	23,08	9	207,73	CHI
202012139130	ITAPURANGA	IK12274465	ITAPURANGA	24/12/2020 14:53	24/12/2020 20:05	24/12/2020 14:53	24/12/2020 20:05	5,19	3	15,57	CHI
202012139222	ITAPURANGA	IK12364740	ITAPURANGA	24/12/2020 14:54	24/12/2020 21:10	24/12/2020 14:54	24/12/2020 21:10	6,25	12	75,04	CHI
202012139222	MORRO AGUDO DE GOIAS	IK12364740	ITAPURANGA	24/12/2020 14:54	24/12/2020 21:10	24/12/2020 14:54	24/12/2020 21:10	6,25	15	93,80	CHI
202012139140	NOVA IGUACU DE GOIAS	NH12086291	CAMPINORTE	24/12/2020 14:55	24/12/2020 16:20	24/12/2020 14:55	24/12/2020 16:20	1,41	6	8,48	CHI
202012139141	IVOLANDIA	IV12249611	IPORA	24/12/2020 14:55	25/12/2020 01:27	24/12/2020 14:55	25/12/2020 01:27	10,53	6	63,16	CHI
202012139141	CAIAPONIA	IV12249611	IPORA	24/12/2020 14:55	25/12/2020 01:27	24/12/2020 14:55	25/12/2020 01:27	10,53	2	21,05	CHI

202012139145	DISTRITO FEDERAL	NJ12290513	MARAJOARA	24/12/2020 14:57	24/12/2020 20:03	24/12/2020 14:57	24/12/2020 20:03	5,11	11	56,20	CHI
202012139164	MINEIROS	MY12322128RE	PARQUE DAS EMAS	24/12/2020 14:58	25/12/2020 10:55	24/12/2020 14:58	25/12/2020 10:55	19,96	4	79,82	CHI
202012139153	PILAR DE GOIAS	GG12238584	SANTA TEREZINHA	24/12/2020 14:59	25/12/2020 10:48	24/12/2020 14:59	25/12/2020 10:48	19,81	8	158,44	CHI
202012144562	SERRANOPOLIS	SX12390579	JATAI S1	24/12/2020 14:59	25/12/2020 15:13	24/12/2020 14:59	25/12/2020 15:13	24,22	3	72,66	CHI
202012139160	BURITI ALEGRE	BG12000167	ITUMBIARA VELHA S2	24/12/2020 15:00	24/12/2020 17:15	24/12/2020 15:00	24/12/2020 17:15	2,24	1	2,24	CHI
202012139292	HEITORAI	HE12023247	ITAPURANGA	24/12/2020 15:04	24/12/2020 20:15	24/12/2020 15:04	24/12/2020 20:15	5,18	5	25,92	CHI
202012139178	NIQUELANDIA	NQ12358174	URUACU	24/12/2020 15:06	25/12/2020 09:13	24/12/2020 15:06	25/12/2020 09:13	18,11	5	90,54	CHI
202012139179	GUARINOS	IW12335647	RUBIATABA	24/12/2020 15:07	25/12/2020 10:52	24/12/2020 15:07	25/12/2020 10:52	19,75	2	39,50	CHI
202012139179	ITAPACI	IW12335647	RUBIATABA	24/12/2020 15:07	25/12/2020 10:52	24/12/2020 15:07	25/12/2020 10:52	19,75	2	39,50	CHI
202012139196	SANTA HELENA DE GOIAS	BZ12295804	ACREUNA	24/12/2020 15:11	24/12/2020 16:21	24/12/2020 15:11	24/12/2020 16:21	1,17	5	5,83	CHI
202012139196	RIO VERDE	BZ12295804	ACREUNA	24/12/2020 15:11	24/12/2020 16:21	24/12/2020 15:11	24/12/2020 16:21	1,17	25	29,13	CHI
202012139196	SANTO ANTONIO DA BARRA	BZ12295804	ACREUNA	24/12/2020 15:11	24/12/2020 16:21	24/12/2020 15:11	24/12/2020 16:21	1,17	45	52,43	CHI
202012139191	TRES RANCHOS	TH12054833	CATALAO S1	24/12/2020 15:12	25/12/2020 00:30	24/12/2020 15:12	24/12/2020 17:36	2,40	273	654,06	CHI
202012139191	TRES RANCHOS	TH12054833	CATALAO S1	24/12/2020 15:12	25/12/2020 00:30	24/12/2020 17:52	25/12/2020 00:30	6,62	273	1807,72	CHI
202012139192	ITUMBIARA	IT12257996	ITUMBIARA VELHA S2	24/12/2020 15:12	24/12/2020 18:02	24/12/2020 15:12	24/12/2020 18:02	2,82	3	8,47	CHI
202012139208	MINACU	IH12242031	MINACU	24/12/2020 15:16	24/12/2020 20:50	24/12/2020 15:16	24/12/2020 20:50	5,57	4	22,27	CHI
202012139387	ITAPURANGA	IK12310530LD	ITAPURANGA	24/12/2020 15:17	24/12/2020 18:03	24/12/2020 15:17	24/12/2020 18:03	2,76	13	35,86	CHI
202012139219	MINEIROS	MY21296360	PARQUE DAS EMAS	24/12/2020 15:18	25/12/2020 14:37	24/12/2020 15:18	25/12/2020 13:19	22,02	1	22,02	CHI
202012139219	MINEIROS	MY12164239	PARQUE DAS EMAS	24/12/2020 15:18	25/12/2020 14:37	25/12/2020 13:00	25/12/2020 14:37	1,62	2	3,23	CHI
202012140180	HIDROLINA	GE12382134	BARRO ALTO	24/12/2020 15:18	25/12/2020 03:21	24/12/2020 15:18	25/12/2020 03:21	12,04	1	12,04	CHI
202012140180	SAO LUIZ DO NORTE	GE12382134	BARRO ALTO	24/12/2020 15:18	25/12/2020 03:21	24/12/2020 15:18	25/12/2020 03:21	12,04	8	96,30	CHI
202012139270	CAIAPONIA	PH12259516	CAIAPONIA	24/12/2020 15:23	25/12/2020 00:43	24/12/2020 15:23	25/12/2020 00:43	9,33	3	27,98	CHI
202012139270	PIRANHAS	PH12259516	CAIAPONIA	24/12/2020 15:23	25/12/2020 00:43	24/12/2020 15:23	25/12/2020 00:43	9,33	70	652,87	CHI
202012139239	FLORES DE GOIAS	FB12426799	IACIARA S2	24/12/2020 15:25	24/12/2020 22:00	24/12/2020 15:25	24/12/2020 22:00	6,59	18	118,67	CHI
202012139262	JARAGUA	JA12254078	JARAGUA	24/12/2020 15:28	24/12/2020 16:09	24/12/2020 15:28	24/12/2020 16:09	0,67	26	17,51	CHI
202012139268	JANDAIA	JD12373324	PALMEIRAS	24/12/2020 15:31	24/12/2020 17:26	24/12/2020 15:31	24/12/2020 17:26	1,91	149	284,42	CHI
202012139273	SANTA TEREZINHA DE GOIAS	NH12202110RE	SANTA TEREZINHA	24/12/2020 15:32	24/12/2020 20:47	24/12/2020 15:32	24/12/2020 20:47	5,25	23	120,71	CHI
202012139273	ALTO HORIZONTE	NH12202110RE	SANTA TEREZINHA	24/12/2020 15:32	24/12/2020 20:47	24/12/2020 15:32	24/12/2020 20:47	5,25	12	62,98	CHI
202012139273	PILAR DE GOIAS	NH12202110RE	SANTA TEREZINHA	24/12/2020 15:32	24/12/2020 20:47	24/12/2020 15:32	24/12/2020 20:47	5,25	9	47,23	CHI
202012139293	GOIANIA	GN12001724	AEROPORTO S1	24/12/2020 15:38	24/12/2020 17:06	24/12/2020 15:38	24/12/2020 17:06	1,46	58	84,62	CHI
202012139297	MINEIROS	10007718096	PARQUE DAS EMAS	24/12/2020 15:39	24/12/2020 21:22	24/12/2020 15:39	24/12/2020 21:22	5,71	1	5,71	CHI
202012139306	LEOPOLDO DE BULHOES	950032013	CEPAIGO S2	24/12/2020 15:42	24/12/2020 23:07	24/12/2020 15:42	24/12/2020 23:07	7,41	1	7,41	CHI
202012139813	APORE	AE12241904	ITAJA S2	24/12/2020 15:43	24/12/2020 23:50	24/12/2020 15:43	24/12/2020 23:50	8,10	4	32,41	CHI
202012139312	IACIARA	IA21232151	IACIARA S1	24/12/2020 15:44	24/12/2020 23:34	24/12/2020 15:44	24/12/2020 23:34	7,83	1	7,83	CHI
202012139314	JATAI	JT12136073	JATAI S1	24/12/2020 15:44	25/12/2020 16:00	24/12/2020 15:44	25/12/2020 16:00	24,25	2	48,51	CHI
202012139343	ACREUNA	EU12260945	ACREUNA	24/12/2020 15:54	24/12/2020 17:36	24/12/2020 15:54	24/12/2020 17:36	1,70	1	1,70	CHI
202012139346	MONTES CLAROS DE GOIAS	DI12188303	ARENOPOLIS	24/12/2020 15:56	24/12/2020 18:04	24/12/2020 15:56	24/12/2020 18:04	2,13	1	2,13	CHI
202012139346	DIORAMA	DI12188303	ARENOPOLIS	24/12/2020 15:56	24/12/2020 18:04	24/12/2020 15:56	24/12/2020 18:04	2,13	28	59,70	CHI
202012139353	BOM JARDIM DE GOIAS	BM11005055	BOM JARDIM	24/12/2020 15:57	24/12/2020 19:35	24/12/2020 15:57	24/12/2020 19:35	3,62	103	373,26	CHI
202012139377	NIQUELANDIA	NQ12239432	URUACU	24/12/2020 15:57	24/12/2020 18:34	24/12/2020 15:57	24/12/2020 18:34	2,60	21	54,68	CHI
202012139359	PALESTINA DE GOIAS	PY21354510	PALESTINA	24/12/2020 15:59	25/12/2020 01:37	24/12/2020 15:59	25/12/2020 01:37	9,63	1	9,63	CHI
202012139366	PEROLANDIA	DP12210071	JATAI S1	24/12/2020 16:01	24/12/2020 17:34	24/12/2020 16:01	24/12/2020 17:34	1,55	2	3,09	CHI
202012139394	ANICUNS	AC12000067	ANICUNS	24/12/2020 16:02	24/12/2020 17:10	24/12/2020 16:02	24/12/2020 17:10	1,12	15	16,86	CHI
202012179393	CABECEIRAS	03740424	ITUIQUIRA	24/12/2020 16:06	25/12/2020 12:45	24/12/2020 16:06	24/12/2020 16:50	0,73	3002	2203,13	CHI
202012179393	DISTRITO FEDERAL	03740424	ITUIQUIRA	24/12/2020 16:06	25/12/2020 12:45	24/12/2020 16:06	24/12/2020 16:50	0,73	1	0,73	CHI
202012179393	CABECEIRAS	03740424	ITUIQUIRA	24/12/2020 16:06	25/12/2020 12:45	24/12/2020 16:06	24/12/2020 17:37	1,53	37	56,56	CHI
202012179393	CABECEIRAS	03740424	ITUIQUIRA	24/12/2020 16:06	25/12/2020 12:45	24/12/2020 16:06	24/12/2020 18:16	2,17	1	2,17	CHI
202012179393	CABECEIRAS	CW16413226	ITUIQUIRA	24/12/2020 16:06	25/12/2020 12:45	24/12/2020 19:21	24/12/2020 19:25	0,07	904	67,55	CHI
202012179393	DISTRITO FEDERAL	CW10383320	ITUIQUIRA	24/12/2020 16:06	25/12/2020 12:45	24/12/2020 19:21	24/12/2020 19:30	0,15	1	0,15	CHI
202012179393	CABECEIRAS	CW10383320	ITUIQUIRA	24/12/2020 16:06	25/12/2020 12:45	24/12/2020 19:21	24/12/2020 19:30	0,15	119	17,78	CHI
202012179393	DISTRITO FEDERAL	CW16413226	ITUIQUIRA	24/12/2020 16:06	25/12/2020 12:45	24/12/2020 19:33	24/12/2020 19:39	0,10	1	0,10	CHI

202012179393	CABECEIRAS	CW16413226	ITUIQUIRA	24/12/2020 16:06	25/12/2020 12:45	24/12/2020 19:33	24/12/2020 19:39	0,10	1023	104,57	CHI
202012179393	CABECEIRAS	CW16416911	ITUIQUIRA	24/12/2020 16:06	25/12/2020 12:45	24/12/2020 19:33	24/12/2020 19:47	0,24	704	168,18	CHI
202012179393	FORMOSA	03740424	ITUIQUIRA	24/12/2020 16:06	25/12/2020 12:45	24/12/2020 16:06	24/12/2020 22:12	6,10	4	24,40	CHI
202012179393	CABECEIRAS	CW16416911	ITUIQUIRA	24/12/2020 16:06	25/12/2020 12:45	24/12/2020 20:12	24/12/2020 23:53	3,69	399	1471,98	CHI
202012179393	CABECEIRAS	CW12171503	ITUIQUIRA	24/12/2020 16:06	25/12/2020 12:45	24/12/2020 20:12	25/12/2020 00:14	4,04	305	1232,37	CHI
202012179393	FORMOSA	03740424	ITUIQUIRA	24/12/2020 16:06	25/12/2020 12:45	24/12/2020 16:06	25/12/2020 12:22	20,27	2	40,54	CHI
202012179393	CABECEIRAS	03740424	ITUIQUIRA	24/12/2020 16:06	25/12/2020 12:45	24/12/2020 16:06	25/12/2020 12:22	20,27	14	283,76	CHI
202012179393	CABECEIRAS	CW13381516	ITUIQUIRA	24/12/2020 16:06	25/12/2020 12:45	25/12/2020 12:42	25/12/2020 12:45	0,06	38	2,12	CHI
202012139523	BONOPOLIS	BX12202590	SAO MIGUEL DO ARAGUAIA	24/12/2020 16:09	24/12/2020 20:45	24/12/2020 16:09	24/12/2020 20:45	4,60	12	55,19	CHI
202012139434	VILA PROPICIO	PV12069121	GOIANESIA S1	24/12/2020 16:10	24/12/2020 22:33	24/12/2020 16:10	24/12/2020 22:33	6,38	3	19,14	CHI
202012139434	BARRO ALTO	PV12069121	GOIANESIA S1	24/12/2020 16:10	24/12/2020 22:33	24/12/2020 16:10	24/12/2020 22:33	6,38	1	6,38	CHI
202012139404	CALDAS NOVAS	760078993	SERRA DE CALDAS	24/12/2020 16:11	24/12/2020 23:12	24/12/2020 16:11	24/12/2020 23:12	7,01	1	7,01	CHI
202012139412	TROMBAS	MX12187848	PORANGATU	24/12/2020 16:13	24/12/2020 18:32	24/12/2020 16:13	24/12/2020 18:32	2,31	1	2,31	CHI
202012139412	MONTIVIDIU DO NORTE	MX12187848	PORANGATU	24/12/2020 16:13	24/12/2020 18:32	24/12/2020 16:13	24/12/2020 18:32	2,31	15	34,64	CHI
202012139414	NOVA CRIXAS	NA12103783	MOZARLANDIA	24/12/2020 16:13	25/12/2020 13:18	24/12/2020 16:13	25/12/2020 13:18	21,08	1	21,08	CHI
202012139417	QUIRINOPOLIS	QI12234616	QUIRINOPOLIS	24/12/2020 16:14	25/12/2020 01:17	24/12/2020 16:14	25/12/2020 01:17	9,04	1	9,04	CHI
202012139424	DIORAMA	DI12260039	ARENOPOLIS	24/12/2020 16:16	24/12/2020 19:57	24/12/2020 16:16	24/12/2020 19:57	3,68	10	36,80	CHI
202012139477	CAIAPONIA	CP12151179	CAIAPONIA	24/12/2020 16:16	24/12/2020 22:10	24/12/2020 16:16	24/12/2020 22:10	5,90	89	525,12	CHI
202012140308	FAZENDA NOVA	JR12231376	JUSSARA	24/12/2020 16:18	25/12/2020 11:45	24/12/2020 16:18	25/12/2020 11:45	19,44	3	58,31	CHI
202012139504	ITARUMA	IM12160235	ITAJA S2	24/12/2020 16:22	25/12/2020 03:23	24/12/2020 16:22	25/12/2020 03:23	11,00	13	143,06	CHI
202012139794	MONTES CLAROS DE GOIAS	ME12023298	IPORA	24/12/2020 16:22	25/12/2020 02:10	24/12/2020 16:22	25/12/2020 02:10	9,80	4	39,18	CHI
202012139573	CAIAPONIA	CP12342210	CAIAPONIA	24/12/2020 16:27	24/12/2020 19:33	24/12/2020 16:27	24/12/2020 19:33	3,10	51	158,04	CHI
202012139475	JATAI	JT12216745	JATAI S1	24/12/2020 16:29	24/12/2020 20:59	24/12/2020 16:29	24/12/2020 20:59	4,50	2	9,01	CHI
202012142276	ALTO HORIZONTE	NH12396799	SANTA TEREZINHA	24/12/2020 16:30	24/12/2020 22:44	24/12/2020 16:30	24/12/2020 22:44	6,23	18	112,17	CHI
202012142276	CAMPOS VERDES	NH12396799	SANTA TEREZINHA	24/12/2020 16:30	24/12/2020 22:44	24/12/2020 16:30	24/12/2020 22:44	6,23	5	31,16	CHI
202012139483	AURILANDIA	AI12194035	FIRMINOPOLIS S2	24/12/2020 16:32	24/12/2020 18:21	24/12/2020 16:32	24/12/2020 18:21	1,81	3	5,43	CHI
202012139515	COCALZINHO DE GOIAS	ZN12377411	COCALZINHO	24/12/2020 16:32	24/12/2020 17:40	24/12/2020 16:32	24/12/2020 17:40	1,12	17	19,05	CHI
202012139494	AGUA FRIA DE GOIAS	NQ12140182	SAO JOAO D ALIANCA	24/12/2020 16:37	24/12/2020 19:43	24/12/2020 16:37	24/12/2020 19:43	3,09	71	219,55	CHI
202012139494	NIQUELANDIA	NQ12140182	SAO JOAO D ALIANCA	24/12/2020 16:37	24/12/2020 19:43	24/12/2020 16:37	24/12/2020 19:43	3,09	5	15,46	CHI
202012139496	JARAGUA	JA21148825	JARAGUA	24/12/2020 16:37	25/12/2020 13:46	24/12/2020 16:37	25/12/2020 13:46	21,15	2	42,30	CHI
202012139499	BURITI DE GOIAS	BS11375304	FIRMINOPOLIS S2	24/12/2020 16:39	24/12/2020 18:07	24/12/2020 16:39	24/12/2020 18:07	1,46	18	26,30	CHI
202012139500	ITARUMA	IM21343788	CACHOEIRA ALTA	24/12/2020 16:39	25/12/2020 02:31	24/12/2020 16:39	25/12/2020 02:31	9,86	1	9,86	CHI
202012139514	IPORA	IR21289223	IPORA	24/12/2020 16:43	25/12/2020 07:00	24/12/2020 16:43	25/12/2020 07:00	14,27	2	28,55	CHI
202012139516	APORE	AE12107327	ITAJA S1	24/12/2020 16:43	24/12/2020 21:38	24/12/2020 16:43	24/12/2020 21:38	4,90	2	9,81	CHI
202012141241	COCALZINHO DE GOIAS	ZN12330813	PADRE BERNARDO	24/12/2020 16:44	25/12/2020 00:43	24/12/2020 16:44	25/12/2020 00:43	7,99	3	23,96	CHI
202012139525	GOIAS	GS12334023	GOIAS	24/12/2020 16:48	24/12/2020 19:04	24/12/2020 16:48	24/12/2020 19:04	2,25	2	4,51	CHI
202012139529	DIORAMA	DI12279325	IPORA	24/12/2020 16:49	24/12/2020 18:54	24/12/2020 16:49	24/12/2020 18:54	2,08	64	132,85	CHI
202012139752	PALMEIRAS DE GOIAS	PL12391507	PALMEIRAS	24/12/2020 16:50	24/12/2020 20:04	24/12/2020 16:50	24/12/2020 20:04	3,22	9	28,95	CHI
202012140117	GOIANESIA	GE12255886	GOIANESIA S1	24/12/2020 16:50	24/12/2020 22:35	24/12/2020 16:50	24/12/2020 22:35	5,74	5	28,70	CHI
202012140117	BARRO ALTO	GE12255886	GOIANESIA S1	24/12/2020 16:50	24/12/2020 22:35	24/12/2020 16:50	24/12/2020 22:35	5,74	1	5,74	CHI
202012139642	SANTO ANTONIO DA BARRA	RV12301462	ACREUNA	24/12/2020 16:52	24/12/2020 19:36	24/12/2020 16:52	24/12/2020 19:36	2,72	1	2,72	CHI
202012139642	RIO VERDE	RV12301462	ACREUNA	24/12/2020 16:52	24/12/2020 19:36	24/12/2020 16:52	24/12/2020 19:36	2,72	10	27,21	CHI
202012139736	ALEXANIA	AX12308913	CORUMBA	24/12/2020 16:52	24/12/2020 22:32	24/12/2020 16:52	24/12/2020 22:32	5,66	58	328,42	CHI
202012139565	ARUANA	AK21220010	MOZARLANDIA	24/12/2020 16:55	25/12/2020 20:24	24/12/2020 16:55	25/12/2020 20:24	27,49	2	54,97	CHI
202012139572	JUSSARA	1290090236	JUSSARA	24/12/2020 16:56	24/12/2020 18:22	24/12/2020 16:56	24/12/2020 18:22	1,43	1	1,43	CHI
202012139582	FORMOSA	FA21141626	ITUIQUIRA	24/12/2020 16:59	24/12/2020 19:03	24/12/2020 16:59	24/12/2020 19:03	2,07	2	4,13	CHI
202012139586	MONTA ALEGRE DE GOIAS	MA12212699	SAO DOMINGOS	24/12/2020 17:00	24/12/2020 18:24	24/12/2020 17:00	24/12/2020 18:24	1,38	66	91,34	CHI
202012139814	PALESTINA DE GOIAS	PY21187375	IPORA	24/12/2020 17:01	24/12/2020 21:40	24/12/2020 17:01	24/12/2020 21:40	4,65	1	4,65	CHI
202012139593	GOIANIA	GN11169504	GOIANIA LESTE S2	24/12/2020 17:02	24/12/2020 21:33	24/12/2020 17:02	24/12/2020 21:33	4,51	48	216,56	CHI
202012139601	ITUMBIARA	IT21304285	PARANAIBA	24/12/2020 17:04	24/12/2020 20:46	24/12/2020 17:04	24/12/2020 20:46	3,70	1	3,70	CHI
202012139603	GOIANIA	GN12000242	GOIANIA LESTE S1	24/12/2020 17:04	24/12/2020 19:36	24/12/2020 17:04	24/12/2020 19:36	2,53	138	348,53	CHI

202012139616	SILVANIA	SV12310162	VIANOPOLIS	24/12/2020 17:10	25/12/2020 04:20	24/12/2020 17:10	25/12/2020 04:20	11,15	1	11,15	CHI
202012139627	EDEIA	EA11394382	EDEIA	24/12/2020 17:14	24/12/2020 19:11	24/12/2020 17:14	24/12/2020 19:11	1,94	14	27,18	CHI
202012139629	GUARINOS	GG12316076	ITAPACI	24/12/2020 17:15	24/12/2020 23:09	24/12/2020 17:15	24/12/2020 23:09	5,90	3	17,69	CHI
202012139631	ITAPACI	6800546	ITAPACI	24/12/2020 17:15	25/12/2020 02:16	24/12/2020 17:15	25/12/2020 02:16	9,01	106	954,56	CHI
202012139631	GUARINOS	6800546	ITAPACI	24/12/2020 17:15	25/12/2020 02:16	24/12/2020 17:15	25/12/2020 02:16	9,01	20	180,11	CHI
202012139639	SAO MIGUEL DO ARAGUAIA	SM12384229	SAO MIGUEL DO ARAGUAIA	24/12/2020 17:18	25/12/2020 08:27	24/12/2020 17:18	25/12/2020 08:27	15,15	3	45,44	CHI
202012139641	MINEIROS	MY12241778	PARQUE DAS EMAS	24/12/2020 17:18	25/12/2020 11:33	24/12/2020 17:18	25/12/2020 11:33	18,25	12	218,97	CHI
202012139654	MONTES CLAROS DE GOIAS	ME12062825	IPORA	24/12/2020 17:21	24/12/2020 20:04	24/12/2020 17:21	24/12/2020 20:04	2,71	5	13,53	CHI
202012139665	ARUANA	AK12210602	MOZARLANDIA	24/12/2020 17:25	25/12/2020 18:32	24/12/2020 17:25	25/12/2020 18:32	25,11	1	25,11	CHI
202012139667	ANICUNS	AC12061366	ANICUNS	24/12/2020 17:25	25/12/2020 00:58	24/12/2020 17:25	25/12/2020 00:58	7,53	14	105,49	CHI
202012139694	PIRACANJUBA	PJ11047866	ROCHEDO	24/12/2020 17:25	24/12/2020 20:25	24/12/2020 17:25	24/12/2020 20:25	2,99	65	194,21	CHI
202012139670	BURITI ALEGRE	BG12249831	ITUMBIARA VELHA S2	24/12/2020 17:26	24/12/2020 18:30	24/12/2020 17:26	24/12/2020 18:30	1,06	2	2,12	CHI
202012139824	SAO JOAO D ALIANCA	JL12237038	SAO JOAO D ALIANCA	24/12/2020 17:26	24/12/2020 19:21	24/12/2020 17:26	24/12/2020 19:21	1,92	5	9,58	CHI
202012139681	PIRES DO RIO	PR12000028	PIRES DO RIO S1	24/12/2020 17:27	25/12/2020 15:07	24/12/2020 17:27	25/12/2020 15:07	21,66	5	108,29	CHI
202012139685	ITUMBIARA	BJ12257011	BOM JESUS DE GOIAS	24/12/2020 17:28	24/12/2020 19:35	24/12/2020 17:28	24/12/2020 19:35	2,11	5	10,56	CHI
202012139686	NOVA ROMA	ND12392238	IACIARA S2	24/12/2020 17:28	24/12/2020 22:20	24/12/2020 17:28	24/12/2020 22:20	4,86	237	1150,77	CHI
202012139707	GOIAS	GS12087829	ITABERAI S1	24/12/2020 17:29	24/12/2020 19:18	24/12/2020 17:29	24/12/2020 19:18	1,81	4	7,24	CHI
202012139700	SAO JOAO D ALIANCA	JL12383335	SAO JOAO D ALIANCA	24/12/2020 17:33	24/12/2020 20:18	24/12/2020 17:33	24/12/2020 20:18	2,74	11	30,09	CHI
202012141734	NOVA AURORA	CI12263856	VILA CORUMBA	24/12/2020 17:34	25/12/2020 04:16	24/12/2020 17:34	25/12/2020 04:16	10,70	7	74,87	CHI
202012141734	CORUMBAIBA	CI12263856	VILA CORUMBA	24/12/2020 17:34	25/12/2020 04:16	24/12/2020 17:34	25/12/2020 04:16	10,70	13	139,04	CHI
202012139768	APARECIDA DE GOIANIA	AP12000049	CEPAIGO S1	24/12/2020 17:35	24/12/2020 21:11	24/12/2020 17:35	24/12/2020 21:11	3,60	40	144,01	CHI
202012139732	MARA ROSA	MQ12287615	MARA ROSA	24/12/2020 17:38	24/12/2020 20:52	24/12/2020 17:38	24/12/2020 20:52	3,23	4	12,92	CHI
202012139719	PARAUNA	PU12205943RE	PARAUNA	24/12/2020 17:39	24/12/2020 20:49	24/12/2020 17:39	24/12/2020 20:49	3,16	22	69,53	CHI
202012139719	JANDAIA	PU12205943RE	PARAUNA	24/12/2020 17:39	24/12/2020 20:49	24/12/2020 17:39	24/12/2020 20:49	3,16	2	6,32	CHI
202012139720	MINEIROS	MY12296301	PARQUE DAS EMAS	24/12/2020 17:39	25/12/2020 11:00	24/12/2020 17:39	25/12/2020 11:00	17,35	1	17,35	CHI
202012139721	SANTA CRUZ DE GOIAS	BC11012514	PIRES DO RIO S2	24/12/2020 17:40	24/12/2020 19:33	24/12/2020 17:40	24/12/2020 19:33	1,88	68	127,54	CHI
202012139722	MINEIROS	MY21248449	PARQUE DAS EMAS	24/12/2020 17:41	24/12/2020 19:51	24/12/2020 17:41	24/12/2020 19:51	2,15	1	2,15	CHI
202012139723	PEROLANDIA	JT12070005LD	JATAI S1	24/12/2020 17:41	25/12/2020 13:54	24/12/2020 17:41	25/12/2020 13:54	20,20	9	181,83	CHI
202012139723	JATAI	JT12070005LD	JATAI S1	24/12/2020 17:41	25/12/2020 13:54	24/12/2020 17:41	25/12/2020 13:54	20,20	109	2202,19	CHI
202012139769	APARECIDA DE GOIANIA	AP12193733	INDEPENDENCIA S1	24/12/2020 17:42	24/12/2020 19:20	24/12/2020 17:42	24/12/2020 19:20	1,63	155	252,91	CHI
202012139728	SANTA CRUZ DE GOIAS	BC12231405	PIRES DO RIO S2	24/12/2020 17:43	24/12/2020 19:05	24/12/2020 17:43	24/12/2020 19:05	1,36	24	32,57	CHI
202012140148	ABADIANIA	AA12382362	CORUMBA	24/12/2020 17:44	25/12/2020 07:11	24/12/2020 17:44	25/12/2020 07:11	13,44	13	174,71	CHI
202012139823	PORANGATU	PO12378923	PORANGATU	24/12/2020 17:45	24/12/2020 22:13	24/12/2020 17:45	24/12/2020 22:13	4,46	2	8,93	CHI
202012139777	ITAGUARU	IC12250773	ITABERAI S1	24/12/2020 17:46	24/12/2020 20:23	24/12/2020 17:46	24/12/2020 20:23	2,61	94	245,37	CHI
202012140126	JATAI	JT12234396	JATAI S1	24/12/2020 17:46	25/12/2020 11:26	24/12/2020 17:46	25/12/2020 11:26	17,67	9	159,00	CHI
202012139764	AGUA FRIA DE GOIAS	TL12356260	SAO JOAO D ALIANCA	24/12/2020 17:51	24/12/2020 21:47	24/12/2020 17:51	24/12/2020 21:47	3,92	19	74,49	CHI
202012140539	PARANAIGUARA	PC12093843	QUIRINOPOLIS	24/12/2020 17:52	24/12/2020 20:21	24/12/2020 17:52	24/12/2020 20:21	2,48	2	4,96	CHI
202012139770	NOVA CRIXAS	NA12322837	MOZARLANDIA	24/12/2020 17:54	25/12/2020 21:06	24/12/2020 17:54	25/12/2020 21:06	27,19	1	27,19	CHI
202012139778	MORRINHOS	GT12044903	GOIATUBA S2	24/12/2020 17:54	24/12/2020 20:56	24/12/2020 17:54	24/12/2020 20:56	3,02	3	9,06	CHI
202012139778	GOIATUBA	GT12044903	GOIATUBA S2	24/12/2020 17:54	24/12/2020 20:56	24/12/2020 17:54	24/12/2020 20:56	3,02	8	24,17	CHI
202012139773	CACHOEIRA ALTA	CA12075233	CACHOEIRA ALTA	24/12/2020 17:55	24/12/2020 21:34	24/12/2020 17:55	24/12/2020 21:34	3,65	4	14,59	CHI
202012142466	CORUMBA DE GOIAS	7360267	CORUMBA	24/12/2020 17:55	25/12/2020 11:53	24/12/2020 17:55	25/12/2020 11:38	17,71	7	123,94	CHI
202012142466	CORUMBA DE GOIAS	7360267	CORUMBA	24/12/2020 17:55	25/12/2020 11:53	25/12/2020 11:42	25/12/2020 11:53	0,18	7	1,28	CHI
202012144234	PORANGATU	PO12187955	PORANGATU	24/12/2020 18:00	25/12/2020 13:08	24/12/2020 18:00	25/12/2020 13:08	19,13	2	38,26	CHI
202012139800	JARAGUA	JA12000117	JARAGUA	24/12/2020 18:02	25/12/2020 12:50	24/12/2020 18:02	25/12/2020 12:50	18,80	3	56,40	CHI
202012139804	MAURILANDIA	ML21136289	RIO DOS BOIS	24/12/2020 18:04	25/12/2020 00:27	24/12/2020 18:04	25/12/2020 00:27	6,37	1	6,37	CHI
202012139818	UIRAPURU	UP12294696	NOVA CRIXAS	24/12/2020 18:07	25/12/2020 08:32	24/12/2020 18:07	25/12/2020 08:32	14,41	4	57,65	CHI
202012139818	AMARALINA	UP12294696	NOVA CRIXAS	24/12/2020 18:07	25/12/2020 08:32	24/12/2020 18:07	25/12/2020 08:32	14,41	54	778,26	CHI
202012139818	MARA ROSA	UP12294696	NOVA CRIXAS	24/12/2020 18:07	25/12/2020 08:32	24/12/2020 18:07	25/12/2020 08:32	14,41	43	619,73	CHI
202012139818	SANTA TEREZINHA DE GOIAS	UP12294696	NOVA CRIXAS	24/12/2020 18:07	25/12/2020 08:32	24/12/2020 18:07	25/12/2020 08:32	14,41	1	14,41	CHI
202012141632	PALESTINA DE GOIAS	PY21172525	IPORA	24/12/2020 18:08	24/12/2020 22:55	24/12/2020 18:08	24/12/2020 22:55	4,79	1	4,79	CHI

202012139915	CACU	CC12164172LD	CACHOEIRA ALTA	24/12/2020 18:10	25/12/2020 00:17	24/12/2020 18:10	25/12/2020 00:17	6,10	85	518,85	CHI
202012139828	CRISTALINA	KR12167813	CRISTALINA S1	24/12/2020 18:11	25/12/2020 00:42	24/12/2020 18:11	25/12/2020 00:42	6,51	8	52,10	CHI
202012139840	ITARUMA	2310015782	CACHOEIRA ALTA	24/12/2020 18:13	25/12/2020 08:40	24/12/2020 18:13	25/12/2020 08:40	14,44	1	14,44	CHI
202012139860	COCALZINHO DE GOIAS	ZN12377411	COCALZINHO	24/12/2020 18:14	25/12/2020 10:50	24/12/2020 18:14	25/12/2020 10:50	16,60	17	282,17	CHI
202012142307	JUSSARA	BT12274297	BRITANIA	24/12/2020 18:15	25/12/2020 03:14	24/12/2020 18:15	25/12/2020 03:14	8,98	29	260,43	CHI
202012139857	PLANALTINA	PB12281764	PADRE BERNARDO	24/12/2020 18:16	24/12/2020 20:46	24/12/2020 18:16	24/12/2020 20:46	2,49	13	32,36	CHI
202012139868	SAO LUIS DE MONTES BELOS	SL11000047	SAO LUIZ DOS MONTES BELOS	24/12/2020 18:20	24/12/2020 21:13	24/12/2020 18:20	24/12/2020 21:13	2,87	140	401,92	CHI
202012139874	SENADOR CANEDO	SW12358960LD	SENADOR CANEDO	24/12/2020 18:22	25/12/2020 10:00	24/12/2020 18:22	25/12/2020 10:00	15,63	404	6314,41	CHI
202012140147	CAIAPONIA	CP12060848	CAIAPONIA	24/12/2020 18:22	24/12/2020 20:36	24/12/2020 18:22	24/12/2020 20:36	2,22	12	26,62	CHI
202012139923	ANAPOLIS	AN12259042	ANAPOLIS UNIVERSITARIO S2	24/12/2020 18:28	25/12/2020 07:24	24/12/2020 18:28	25/12/2020 07:24	12,93	8	103,47	CHI
202012139913	AGUAS LINDAS DE GOIAS	4830342123	AGUAS LINDAS DE GOIAS S1	24/12/2020 18:31	25/12/2020 07:26	24/12/2020 18:31	25/12/2020 07:26	12,92	1	12,92	CHI
202012140805	GOIANIA	GN12000112	GOIANIA LESTE S1	24/12/2020 18:33	24/12/2020 20:57	24/12/2020 18:33	24/12/2020 20:57	2,38	104	247,95	CHI
202012141971	ARAGARCAS	ME12193486	IPORA	24/12/2020 18:37	25/12/2020 10:41	24/12/2020 18:37	25/12/2020 10:41	16,06	1	16,06	CHI
202012141971	MONTES CLAROS DE GOIAS	ME12193486	IPORA	24/12/2020 18:37	25/12/2020 10:41	24/12/2020 18:37	25/12/2020 10:41	16,06	3	48,19	CHI
202012140007	NOVO GAMA	NJ10404147	MARAJOARA	24/12/2020 18:38	24/12/2020 20:06	24/12/2020 18:38	24/12/2020 18:54	0,25	1397	353,52	CHI
202012140007	NOVO GAMA	NJ10404147	PACAEMBU S1	24/12/2020 18:38	24/12/2020 20:06	24/12/2020 18:38	24/12/2020 18:54	0,25	2538	642,25	CHI
202012140007	NOVO GAMA	NJ16410036	MARAJOARA	24/12/2020 18:38	24/12/2020 20:06	24/12/2020 18:38	24/12/2020 18:56	0,30	2133	644,64	CHI
202012140007	DISTRITO FEDERAL	NJ16410036	MARAJOARA	24/12/2020 18:38	24/12/2020 20:06	24/12/2020 18:38	24/12/2020 18:56	0,30	535	161,69	CHI
202012140007	NOVO GAMA	NJ10417016	MARAJOARA	24/12/2020 18:38	24/12/2020 20:06	24/12/2020 18:38	24/12/2020 18:58	0,33	400	132,33	CHI
202012140007	DISTRITO FEDERAL	NJ16408241	MARAJOARA	24/12/2020 18:38	24/12/2020 20:06	24/12/2020 18:38	24/12/2020 19:07	0,48	412	196,84	CHI
202012140007	DISTRITO FEDERAL	NJ16408241	MARAJOARA	24/12/2020 18:38	24/12/2020 20:06	24/12/2020 18:53	24/12/2020 19:07	0,23	190	44,07	CHI
202012140007	NOVO GAMA	NJ16408241	MARAJOARA	24/12/2020 18:38	24/12/2020 20:06	24/12/2020 18:53	24/12/2020 19:07	0,23	463	107,39	CHI
202012140007	NOVO GAMA	NJ10417016	MARAJOARA	24/12/2020 18:38	24/12/2020 20:06	24/12/2020 19:00	24/12/2020 19:15	0,24	194	46,83	CHI
202012140007	NOVO GAMA	03860214	MARAJOARA	24/12/2020 18:38	24/12/2020 20:06	24/12/2020 19:00	24/12/2020 20:00	0,99	1193	1181,07	CHI
202012140007	NOVO GAMA	NJ16410036	MARAJOARA	24/12/2020 18:38	24/12/2020 20:06	24/12/2020 19:56	24/12/2020 20:00	0,06	2600	150,22	CHI
202012140007	DISTRITO FEDERAL	NJ16410036	MARAJOARA	24/12/2020 18:38	24/12/2020 20:06	24/12/2020 19:56	24/12/2020 20:00	0,06	535	30,91	CHI
202012140007	DISTRITO FEDERAL	NJ16408241	MARAJOARA	24/12/2020 18:38	24/12/2020 20:06	24/12/2020 19:56	24/12/2020 20:01	0,09	750	67,08	CHI
202012140007	NOVO GAMA	NJ16408241	MARAJOARA	24/12/2020 18:38	24/12/2020 20:06	24/12/2020 19:56	24/12/2020 20:01	0,09	652	58,32	CHI
202012140007	NOVO GAMA	NJ10408340	MARAJOARA	24/12/2020 18:38	24/12/2020 20:06	24/12/2020 18:55	24/12/2020 20:03	1,13	2622	2959,22	CHI
202012140007	SANTO ANTONIO DO DESCOBERTO	NJ10408340	MARAJOARA	24/12/2020 18:38	24/12/2020 20:06	24/12/2020 18:55	24/12/2020 20:03	1,13	167	188,48	CHI
202012140007	DISTRITO FEDERAL	NJ10408340	MARAJOARA	24/12/2020 18:38	24/12/2020 20:06	24/12/2020 18:55	24/12/2020 20:03	1,13	4	4,51	CHI
202012140007	VALPARAISO DE GOIAS	03860214	PACAEMBU S1	24/12/2020 18:38	24/12/2020 20:06	24/12/2020 19:00	24/12/2020 20:06	1,10	6514	7145,50	CHI
202012140072	SANTO ANTONIO DO DESCOBERTO	SN12389385	MARAJOARA	24/12/2020 18:44	24/12/2020 21:39	24/12/2020 18:44	24/12/2020 21:39	2,91	82	238,98	CHI
202012140072	DISTRITO FEDERAL	SN12389385	MARAJOARA	24/12/2020 18:44	24/12/2020 21:39	24/12/2020 18:44	24/12/2020 21:39	2,91	3	8,74	CHI
202012140072	ALEXANIA	SN12389385	MARAJOARA	24/12/2020 18:44	24/12/2020 21:39	24/12/2020 18:44	24/12/2020 21:39	2,91	4	11,66	CHI
202012141922	LUZIANIA	00380214	MARAJOARA	24/12/2020 18:44	24/12/2020 21:44	24/12/2020 18:59	24/12/2020 20:06	1,12	1895	2119,77	CHI
202012141922	CIDADE OCIDENTAL	00380214	MARAJOARA	24/12/2020 18:44	24/12/2020 21:44	24/12/2020 18:59	24/12/2020 20:06	1,12	14460	16175,12	CHI
202012141922	VALPARAISO DE GOIAS	00380214	MARAJOARA	24/12/2020 18:44	24/12/2020 21:44	24/12/2020 18:59	24/12/2020 20:06	1,12	246	275,18	CHI
202012141922	LUZIANIA	DH16410974	MARAJOARA	24/12/2020 18:44	24/12/2020 21:44	24/12/2020 20:09	24/12/2020 20:14	0,09	654	56,50	CHI
202012141922	VALPARAISO DE GOIAS	DH16410974	MARAJOARA	24/12/2020 18:44	24/12/2020 21:44	24/12/2020 20:09	24/12/2020 20:14	0,09	130	11,23	CHI
202012141922	CIDADE OCIDENTAL	DH16410974	MARAJOARA	24/12/2020 18:44	24/12/2020 21:44	24/12/2020 20:09	24/12/2020 20:14	0,09	323	27,90	CHI
202012141922	LUZIANIA	LZ10404909	MARAJOARA	24/12/2020 18:44	24/12/2020 21:44	24/12/2020 20:09	24/12/2020 20:17	0,14	1241	168,57	CHI
202012141922	CIDADE OCIDENTAL	DH10403926	MARAJOARA	24/12/2020 18:44	24/12/2020 21:44	24/12/2020 20:09	24/12/2020 20:18	0,14	1577	227,79	CHI
202012141922	VALPARAISO DE GOIAS	DH10403927	MARAJOARA	24/12/2020 18:44	24/12/2020 21:44	24/12/2020 20:09	24/12/2020 20:19	0,16	116	18,75	CHI
202012141922	CIDADE OCIDENTAL	DH10403927	MARAJOARA	24/12/2020 18:44	24/12/2020 21:44	24/12/2020 20:09	24/12/2020 20:19	0,16	3018	487,91	CHI
202012141922	LUZIANIA	LZ10404909	MARAJOARA	24/12/2020 18:44	24/12/2020 21:44	24/12/2020 20:33	24/12/2020 21:33	1,00	1241	1246,17	CHI
202012141922	LUZIANIA	DH10414207	MARAJOARA	24/12/2020 18:44	24/12/2020 21:44	24/12/2020 20:36	24/12/2020 21:33	0,95	192	182,03	CHI
202012141922	VALPARAISO DE GOIAS	DH10414207	MARAJOARA	24/12/2020 18:44	24/12/2020 21:44	24/12/2020 20:36	24/12/2020 21:33	0,95	30	28,44	CHI
202012141922	VALPARAISO DE GOIAS	LZ16408796	MARAJOARA	24/12/2020 18:44	24/12/2020 21:44	24/12/2020 20:36	24/12/2020 21:37	1,01	100	101,42	CHI
202012141922	CIDADE OCIDENTAL	LZ16408796	MARAJOARA	24/12/2020 18:44	24/12/2020 21:44	24/12/2020 20:36	24/12/2020 21:37	1,01	1	1,01	CHI
202012141922	LUZIANIA	LZ16408796	MARAJOARA	24/12/2020 18:44	24/12/2020 21:44	24/12/2020 20:36	24/12/2020 21:37	1,01	436	442,18	CHI

202012141922	VALPARAISO DE GOIAS	DH10414207	MARAJOARA	24/12/2020 18:44	24/12/2020 21:44	24/12/2020 21:41	24/12/2020 21:44	0,05	30	1,51	CHI
202012141922	LUZIANIA	DH10414207	MARAJOARA	24/12/2020 18:44	24/12/2020 21:44	24/12/2020 21:41	24/12/2020 21:44	0,05	1433	72,05	CHI
202012140027	GOIANIA	11014970	FERROVIARIO S3	24/12/2020 18:48	25/12/2020 11:41	24/12/2020 18:48	25/12/2020 11:41	16,88	1	16,88	CHI
202012140055	PALESTINA DE GOIAS	PY12357583	PALESTINA	24/12/2020 18:50	25/12/2020 08:20	24/12/2020 18:50	25/12/2020 08:20	13,49	3	40,47	CHI
202012140090	JATAI	SX12264387RE	JATAI S1	24/12/2020 18:53	25/12/2020 16:46	24/12/2020 18:53	25/12/2020 16:46	21,88	7	153,17	CHI
202012140090	SERRANOPOLIS	SX12264387RE	JATAI S1	24/12/2020 18:53	25/12/2020 16:46	24/12/2020 18:53	25/12/2020 16:46	21,88	23	503,26	CHI
202012140092	SANTO ANTONIO DA BARRA	BZ12301421	ACREUNA	24/12/2020 18:53	24/12/2020 20:13	24/12/2020 18:53	24/12/2020 20:13	1,33	3	3,98	CHI
202012140096	MINEIROS	MY12260468	PARQUE DAS EMAS	24/12/2020 18:53	26/12/2020 00:20	24/12/2020 18:53	26/12/2020 00:20	29,46	5	147,29	CHI
202012140121	EDEIA	EA21044494	EDEIA	24/12/2020 18:56	24/12/2020 20:28	24/12/2020 18:56	24/12/2020 20:28	1,52	1	1,52	CHI
202012141074	ANAPOLIS	AN10410444	ANAPOLIS UNIVERSITARIO S1	24/12/2020 18:57	24/12/2020 20:29	24/12/2020 18:57	24/12/2020 19:51	0,90	10352	9290,92	CHI
202012141074	ANAPOLIS	AN16416828	ANAPOLIS UNIVERSITARIO S1	24/12/2020 18:57	24/12/2020 20:29	24/12/2020 18:59	24/12/2020 19:51	0,86	107	92,35	CHI
202012141074	ANAPOLIS	AN16413901	ANAPOLIS UNIVERSITARIO S1	24/12/2020 18:57	24/12/2020 20:29	24/12/2020 19:52	24/12/2020 20:19	0,44	2081	926,04	CHI
202012141074	ANAPOLIS	AN16405458	ANAPOLIS UNIVERSITARIO S1	24/12/2020 18:57	24/12/2020 20:29	24/12/2020 19:55	24/12/2020 20:19	0,40	5042	2009,80	CHI
202012141074	ANAPOLIS	AN16400296	ANAPOLIS UNIVERSITARIO S1	24/12/2020 18:57	24/12/2020 20:29	24/12/2020 19:53	24/12/2020 20:22	0,49	1047	516,81	CHI
202012141074	ANAPOLIS	AN10410444	ANAPOLIS UNIVERSITARIO S2	24/12/2020 18:57	24/12/2020 20:29	24/12/2020 18:57	24/12/2020 20:28	1,51	2737	4129,07	CHI
202012141074	CAMPO LIMPO	AN10410444	ANAPOLIS UNIVERSITARIO S2	24/12/2020 18:57	24/12/2020 20:29	24/12/2020 18:57	24/12/2020 20:28	1,51	7	10,56	CHI
202012141074	PIRENOPOLIS	AN10410444	ANAPOLIS UNIVERSITARIO S2	24/12/2020 18:57	24/12/2020 20:29	24/12/2020 18:57	24/12/2020 20:29	1,53	86	131,99	CHI
202012141074	ANAPOLIS	AN10410444	ANAPOLIS UNIVERSITARIO S2	24/12/2020 18:57	24/12/2020 20:29	24/12/2020 18:57	24/12/2020 20:29	1,53	3215	4934,13	CHI
202012141074	CAMPO LIMPO	AN10410444	ANAPOLIS UNIVERSITARIO S2	24/12/2020 18:57	24/12/2020 20:29	24/12/2020 18:57	24/12/2020 20:29	1,53	11	16,88	CHI
202012141074	ABADIANIA	AN10410444	ANAPOLIS UNIVERSITARIO S2	24/12/2020 18:57	24/12/2020 20:29	24/12/2020 18:57	24/12/2020 20:29	1,53	18	27,63	CHI
202012142309	VALPARAISO DE GOIAS	LZ12000199	PACAEMBU S1	24/12/2020 18:57	24/12/2020 22:31	24/12/2020 18:57	24/12/2020 22:31	3,55	349	1240,11	CHI
202012139743	LEOPOLDO DE BULHOES	LB12302184	DAIA S2	24/12/2020 18:58	24/12/2020 22:38	24/12/2020 18:58	24/12/2020 22:38	3,65	8	29,23	CHI
202012140585	CUMARI	CY12061105RE	CATALAO S2	24/12/2020 19:03	24/12/2020 22:57	24/12/2020 19:03	24/12/2020 22:57	3,89	17	66,19	CHI
202012140262	ALEXANIA	AX12384864	ALEXANIA	24/12/2020 19:05	24/12/2020 22:33	24/12/2020 19:05	24/12/2020 22:33	3,46	79	273,27	CHI
202012140270	JATAI	JT12115871	JATAI S1	24/12/2020 19:08	25/12/2020 09:42	24/12/2020 19:08	25/12/2020 09:42	14,56	7	101,93	CHI
202012140650	GOIANIRA	00550234	GOIANIRA	24/12/2020 19:09	24/12/2020 21:02	24/12/2020 19:09	24/12/2020 19:54	0,74	1232	914,42	CHI
202012140650	GOIANIRA	GR16435313	GOIANIRA	24/12/2020 19:09	24/12/2020 21:02	24/12/2020 19:09	24/12/2020 19:57	0,79	1148	906,92	CHI
202012140650	TRINDADE	GR10396914	GOIANIRA	24/12/2020 19:09	24/12/2020 21:02	24/12/2020 19:09	24/12/2020 19:57	0,80	3	2,40	CHI
202012140650	GOIANIRA	GR10396914	GOIANIRA	24/12/2020 19:09	24/12/2020 21:02	24/12/2020 19:09	24/12/2020 19:57	0,80	2203	1762,40	CHI
202012140650	GOIANIRA	GR10435311	GOIANIRA	24/12/2020 19:09	24/12/2020 21:02	24/12/2020 19:09	24/12/2020 19:58	0,82	2269	1851,76	CHI
202012140650	TRINDADE	GR10435311	GOIANIRA	24/12/2020 19:09	24/12/2020 21:02	24/12/2020 19:09	24/12/2020 19:58	0,82	31	25,30	CHI
202012140650	GOIANIRA	TR16409627	GOIANIRA	24/12/2020 19:09	24/12/2020 21:02	24/12/2020 19:09	24/12/2020 19:58	0,82	1187	975,32	CHI
202012140650	TRINDADE	TR16409627	GOIANIRA	24/12/2020 19:09	24/12/2020 21:02	24/12/2020 19:09	24/12/2020 19:58	0,82	65	53,41	CHI
202012140650	GOIANIRA	GR16413314	GOIANIRA	24/12/2020 19:09	24/12/2020 21:02	24/12/2020 19:09	24/12/2020 20:04	0,91	666	604,95	CHI
202012140650	GOIANIRA	GR16435313	GOIANIRA	24/12/2020 19:09	24/12/2020 21:02	24/12/2020 20:01	24/12/2020 20:06	0,07	1148	79,40	CHI
202012140650	GOIANIRA	GR10435311	GOIANIRA	24/12/2020 19:09	24/12/2020 21:02	24/12/2020 20:01	24/12/2020 20:07	0,09	228	21,41	CHI
202012140650	TRINDADE	GR10435311	GOIANIRA	24/12/2020 19:09	24/12/2020 21:02	24/12/2020 20:01	24/12/2020 20:07	0,09	31	2,91	CHI
202012140650	TRINDADE	TR16409627	GOIANIRA	24/12/2020 19:09	24/12/2020 21:02	24/12/2020 20:01	24/12/2020 20:09	0,13	1	0,13	CHI
202012140650	GOIANIRA	TR16409627	GOIANIRA	24/12/2020 19:09	24/12/2020 21:02	24/12/2020 20:01	24/12/2020 20:09	0,13	479	61,60	CHI
202012140650	GOIANIRA	GR10402773	GOIANIRA	24/12/2020 19:09	24/12/2020 21:02	24/12/2020 20:01	24/12/2020 20:10	0,14	2041	288,57	CHI
202012140650	TRINDADE	GR10403988	GOIANIRA	24/12/2020 19:09	24/12/2020 21:02	24/12/2020 20:01	24/12/2020 20:12	0,17	51	8,84	CHI
202012140650	GOIANIRA	GR10403989	GOIANIRA	24/12/2020 19:09	24/12/2020 21:02	24/12/2020 20:01	24/12/2020 20:12	0,17	677	117,35	CHI
202012140650	TRINDADE	GR10403989	GOIANIRA	24/12/2020 19:09	24/12/2020 21:02	24/12/2020 20:01	24/12/2020 20:12	0,17	15	2,60	CHI
202012140650	GOIANIRA	GR10410401	GOIANIRA	24/12/2020 19:09	24/12/2020 21:02	24/12/2020 20:01	24/12/2020 20:13	0,20	32	6,28	CHI
202012140650	TRINDADE	GR10396914	GOIANIRA	24/12/2020 19:09	24/12/2020 21:02	24/12/2020 20:01	24/12/2020 20:20	0,32	2	0,64	CHI
202012140650	GOIANIRA	GR10396914	GOIANIRA	24/12/2020 19:09	24/12/2020 21:02	24/12/2020 20:01	24/12/2020 20:20	0,32	865	274,88	CHI
202012140650	TRINDADE	GR16407508	GOIANIRA	24/12/2020 19:09	24/12/2020 21:02	24/12/2020 20:01	24/12/2020 20:22	0,35	1	0,35	CHI
202012140650	GOIANIRA	GR16407508	GOIANIRA	24/12/2020 19:09	24/12/2020 21:02	24/12/2020 20:01	24/12/2020 20:22	0,35	1338	467,56	CHI
202012140650	GOIANIRA	GR10402773	GOIANIRA	24/12/2020 19:09	24/12/2020 21:02	24/12/2020 20:22	24/12/2020 21:02	0,67	2041	1358,97	CHI
202012140323	MINEIROS	O1140434	PARQUE DAS EMAS	24/12/2020 19:11	24/12/2020 21:23	24/12/2020 19:11	24/12/2020 21:23	2,20	91	199,97	CHI
202012141046	AGUAS LINDAS DE GOIAS	LA10394623	AGUAS LINDAS DE GOIAS S1	24/12/2020 19:12	24/12/2020 19:34	24/12/2020 19:12	24/12/2020 19:34	0,37	10740	3991,70	CHI

202012141046	COCALZINHO DE GOIAS	LA10394623	AGUAS LINDAS DE GOIAS S1	24/12/2020 19:12	24/12/2020 19:34	24/12/2020 19:12	24/12/2020 19:34	0,37	287	106,67	CHI
202012141434	MUTUNOPOLIS	MU12391672	MARA ROSA	24/12/2020 19:12	25/12/2020 08:14	24/12/2020 19:12	25/12/2020 08:14	13,02	7	91,13	CHI
202012141434	AMARALINA	MU12391672	MARA ROSA	24/12/2020 19:12	25/12/2020 08:14	24/12/2020 19:12	25/12/2020 08:14	13,02	101	1314,88	CHI
202012140466	LUZIANIA	LZ11136563	RIO VERMELHO	24/12/2020 19:16	24/12/2020 21:58	24/12/2020 19:16	24/12/2020 21:58	2,69	108	290,01	CHI
202012140468	FORMOSA	FA12106825	ITIQUEIRA	24/12/2020 19:16	24/12/2020 20:31	24/12/2020 19:16	24/12/2020 20:31	1,23	880	1086,07	CHI
202012141470	NIQUELANDIA	NQ12400337	URUACU	24/12/2020 19:17	25/12/2020 09:52	24/12/2020 19:17	25/12/2020 09:52	14,58	15	218,64	CHI
202012140520	ITARUMA	2310009964	CACHOEIRA ALTA	24/12/2020 19:18	25/12/2020 10:35	24/12/2020 19:18	25/12/2020 10:35	15,29	1	15,29	CHI
202012141232	ANAPOLIS	AN11068145	ANAPOLIS UNIVERSITARIO S2	24/12/2020 19:19	24/12/2020 21:40	24/12/2020 19:19	24/12/2020 21:40	2,35	201	472,35	CHI
202012140604	LEOPOLDO DE BULHOES	6847829	VIANOPOLIS	24/12/2020 19:20	25/12/2020 01:06	24/12/2020 19:20	25/12/2020 01:06	5,75	1	5,75	CHI
202012140615	TRINDADE	40100923	TRINDADE	24/12/2020 19:21	24/12/2020 22:17	24/12/2020 19:21	24/12/2020 22:17	2,94	1	2,94	CHI
202012140719	SANTO ANTONIO DE GOIAS	BW12146000	NEROPOLIS S1	24/12/2020 19:22	24/12/2020 22:08	24/12/2020 19:22	24/12/2020 22:08	2,76	508	1404,20	CHI
202012141607	PADRE BERNARDO	PB12261643	PADRE BERNARDO	24/12/2020 19:22	24/12/2020 20:42	24/12/2020 19:22	24/12/2020 20:42	1,33	203	270,38	CHI
202012142096	CACHOEIRA ALTA	AW10409335	CACHOEIRA ALTA	24/12/2020 19:22	24/12/2020 20:58	24/12/2020 19:22	24/12/2020 20:58	1,61	67	107,67	CHI
202012142096	APARECIDA DO RIO DOCE	AW10409335	CACHOEIRA ALTA	24/12/2020 19:22	24/12/2020 20:58	24/12/2020 19:22	24/12/2020 20:58	1,61	221	355,13	CHI
202012142096	RIO VERDE	AW10409335	CACHOEIRA ALTA	24/12/2020 19:22	24/12/2020 20:58	24/12/2020 19:22	24/12/2020 20:58	1,61	8	12,86	CHI
202012140710	PADRE BERNARDO	PB12256732	PADRE BERNARDO	24/12/2020 19:23	24/12/2020 22:06	24/12/2020 19:23	24/12/2020 22:06	2,70	182	491,65	CHI
202012140780	AGUAS LINDAS DE GOIAS	LA12165006	AGUAS LINDAS DE GOIAS S2	24/12/2020 19:25	25/12/2020 01:50	24/12/2020 19:25	25/12/2020 01:27	6,04	1270	7668,68	CHI
202012140780	AGUAS LINDAS DE GOIAS	LA12165006	AGUAS LINDAS DE GOIAS S2	24/12/2020 19:25	25/12/2020 01:50	24/12/2020 19:25	25/12/2020 01:45	6,32	152	961,06	CHI
202012140780	AGUAS LINDAS DE GOIAS	LA12165006	AGUAS LINDAS DE GOIAS S2	24/12/2020 19:25	25/12/2020 01:50	24/12/2020 19:25	25/12/2020 01:50	6,41	138	884,01	CHI
202012140823	PLANALTINA	PI12043443	PLANALTINA	24/12/2020 19:27	24/12/2020 20:40	24/12/2020 19:27	24/12/2020 20:40	1,21	496	599,47	CHI
202012140889	GOIANIA	GN11042200	FERROVIARIO S2	24/12/2020 19:27	24/12/2020 20:29	24/12/2020 19:27	24/12/2020 20:29	1,04	105	108,91	CHI
202012142046	ALEXANIA	AX12221403	ALEXANIA	24/12/2020 19:29	24/12/2020 22:04	24/12/2020 19:29	24/12/2020 22:04	2,57	128	328,92	CHI
202012144564	SERRANOPOLIS	SX12241669	JATAI S1	24/12/2020 19:29	25/12/2020 15:54	24/12/2020 19:29	25/12/2020 15:54	20,41	13	265,32	CHI
202012141135	GOIANIA	GN11000871	FERROVIARIO S1	24/12/2020 19:32	25/12/2020 08:12	24/12/2020 19:32	25/12/2020 08:12	12,66	42	531,52	CHI
202012141823	ARAGARCAS	AG16410731	ARAGARCAS	24/12/2020 19:32	25/12/2020 01:26	24/12/2020 19:32	25/12/2020 01:26	5,91	1132	6688,86	CHI
202012141933	GOIANIA	GN12167860	CARAJAS S2	24/12/2020 19:32	25/12/2020 00:40	24/12/2020 19:32	25/12/2020 00:40	5,13	426	2183,60	CHI
202012141041	GOIANIA	GN12000471	FERROVIARIO S1	24/12/2020 19:34	25/12/2020 08:12	24/12/2020 19:34	25/12/2020 08:12	12,62	5	63,08	CHI
202012141414	ANAPOLIS	AN12272994	ANAPOLIS UNIVERSITARIO S2	24/12/2020 19:35	24/12/2020 23:08	24/12/2020 19:35	24/12/2020 23:08	3,54	342	1210,68	CHI
202012141083	LUZIANIA	LZ11061777	MARAJOARA	24/12/2020 19:36	24/12/2020 22:41	24/12/2020 19:36	24/12/2020 22:41	3,07	26	79,86	CHI
202012142436	MINEIROS	MY12360720RE	PARQUE DAS EMAS	24/12/2020 19:37	25/12/2020 18:00	24/12/2020 19:37	25/12/2020 18:00	22,38	4	89,50	CHI
202012141649	GOIANIA	GN12167862	CARAJAS S2	24/12/2020 19:39	25/12/2020 01:13	24/12/2020 19:39	25/12/2020 01:13	5,55	226	1254,80	CHI
202012141185	LUZIANIA	LZ12041476	RIO VERMELHO	24/12/2020 19:40	24/12/2020 21:58	24/12/2020 19:40	24/12/2020 21:58	2,29	23	52,70	CHI
202012141352	BELA VISTA DE GOIAS	BV11045927	BELA VISTA S1	24/12/2020 19:48	24/12/2020 20:27	24/12/2020 19:48	24/12/2020 20:27	0,64	190	122,23	CHI
202012141407	MARA ROSA	MQ12170945	MARA ROSA	24/12/2020 19:50	25/12/2020 16:08	24/12/2020 19:50	25/12/2020 16:08	20,28	5	101,42	CHI
202012141413	CACHOEIRA ALTA	CA12200648	CACHOEIRA ALTA	24/12/2020 19:51	24/12/2020 23:34	24/12/2020 19:51	24/12/2020 23:34	3,72	2	7,43	CHI
202012141435	SILVANIA	SV12282723	VIANOPOLIS	24/12/2020 19:52	24/12/2020 22:03	24/12/2020 19:52	24/12/2020 22:03	2,18	6	13,07	CHI
202012141495	CORUMBA DE GOIAS	ZN12382309	COCALZINHO	24/12/2020 19:53	24/12/2020 22:41	24/12/2020 19:53	24/12/2020 22:41	2,79	67	186,87	CHI
202012141516	CACHOEIRA DOURADA	CD12273971	CACHOEIRA DOURADA	24/12/2020 19:56	24/12/2020 23:11	24/12/2020 19:56	24/12/2020 23:11	3,24	2	6,47	CHI
202012141811	FORMOSA	FA12000124	ITIQUEIRA	24/12/2020 19:56	24/12/2020 20:55	24/12/2020 19:56	24/12/2020 20:55	0,97	520	503,24	CHI
202012141537	FORMOSO	FO12065548	PORANGATU	24/12/2020 19:57	24/12/2020 21:43	24/12/2020 19:57	24/12/2020 21:43	1,75	290	508,31	CHI
202012141666	PETROLINA DE GOIAS	PG12116335	PETROLINA	24/12/2020 19:58	25/12/2020 12:30	24/12/2020 19:58	25/12/2020 12:30	16,52	34	561,73	CHI
202012141619	CAIAPONIA	CP12269004	CAIAPONIA	24/12/2020 20:02	25/12/2020 04:33	24/12/2020 20:02	25/12/2020 04:33	8,51	5	42,55	CHI
202012141630	APARECIDA DE GOIANIA	AP11345614	CEPAIGO S1	24/12/2020 20:03	24/12/2020 22:31	24/12/2020 20:03	24/12/2020 22:31	2,46	165	405,44	CHI
202012142197	ANAPOLIS	AN12000025	ANAPOLIS UNIVERSITARIO S2	24/12/2020 20:04	25/12/2020 05:56	24/12/2020 20:04	25/12/2020 05:56	9,85	216	2128,44	CHI
202012141669	CACHOEIRA DOURADA	CD12352616	CACHOEIRA DOURADA	24/12/2020 20:06	24/12/2020 23:45	24/12/2020 20:06	24/12/2020 23:45	3,64	1	3,64	CHI
202012141679	AGUA LIMPA	AL12024213	VILA CORUMBA	24/12/2020 20:07	24/12/2020 23:49	24/12/2020 20:07	24/12/2020 23:49	3,70	2	7,40	CHI
202012142009	IPAMERI	IP12000007	IPAMERI	24/12/2020 20:08	24/12/2020 21:49	24/12/2020 20:08	24/12/2020 21:49	1,67	239	398,86	CHI
202012141724	MINEIROS	1390065446	PARQUE DAS EMAS	24/12/2020 20:10	25/12/2020 17:27	24/12/2020 20:10	25/12/2020 17:27	21,28	1	21,28	CHI
202012142006	FORMOSA	FA12195774	ITIQUEIRA	24/12/2020 20:12	24/12/2020 23:21	24/12/2020 20:12	24/12/2020 23:21	3,14	673	2114,53	CHI
202012141785	ARENOPOLIS	AY12235874	IPORA	24/12/2020 20:15	25/12/2020 08:24	24/12/2020 20:15	25/12/2020 08:24	12,14	7	84,97	CHI
202012141785	PIRANHAS	AY12235874	IPORA	24/12/2020 20:15	25/12/2020 08:24	24/12/2020 20:15	25/12/2020 08:24	12,14	1	12,14	CHI

202012142365	CORUMBAIBA	CI12035404	VILA CORUMBA	24/12/2020 20:15	25/12/2020 09:07	24/12/2020 20:15	25/12/2020 09:07	12,86	83	1067,24	CHI
202012142177	ANAPOLIS	AN11347826	DAIA S1	24/12/2020 20:25	25/12/2020 00:10	24/12/2020 20:25	25/12/2020 00:10	3,75	175	655,81	CHI
202012142908	JUSSARA	JR12362437	BRITANIA	24/12/2020 20:25	25/12/2020 16:01	24/12/2020 20:25	25/12/2020 16:01	19,59	7	137,11	CHI
202012142908	FAZENDA NOVA	JR12362437	BRITANIA	24/12/2020 20:25	25/12/2020 16:01	24/12/2020 20:25	25/12/2020 16:01	19,59	3	58,76	CHI
202012141888	PADRE BERNARDO	PB11133204	PADRE BERNARDO	24/12/2020 20:26	24/12/2020 21:36	24/12/2020 20:26	24/12/2020 21:36	1,15	87	100,39	CHI
202012141891	PLANALTINA	PI11129908	PLANALTINA	24/12/2020 20:27	24/12/2020 21:19	24/12/2020 20:27	24/12/2020 21:19	0,86	197	170,35	CHI
202012141972	ARAGUAPAZ	AZ12210560	MOZARLANDIA	24/12/2020 20:27	24/12/2020 21:41	24/12/2020 20:27	24/12/2020 21:41	1,22	147	179,30	CHI
202012141972	MOZARLANDIA	AZ12210560	MOZARLANDIA	24/12/2020 20:27	24/12/2020 21:41	24/12/2020 20:27	24/12/2020 21:41	1,22	2	2,44	CHI
202012141920	LUZIANIA	LZ11169066	RIO VERMELHO	24/12/2020 20:30	24/12/2020 21:43	24/12/2020 20:30	24/12/2020 21:43	1,21	146	176,70	CHI
202012142133	EDEIA	EA12000048	EDEIA	24/12/2020 20:32	24/12/2020 22:50	24/12/2020 20:32	24/12/2020 22:50	2,30	32	73,56	CHI
202012142445	AVELINOPOLIS	AV12019687	ANICUNS	24/12/2020 20:39	25/12/2020 03:57	24/12/2020 20:39	25/12/2020 03:57	7,29	8	58,29	CHI
202012142066	DIORAMA	DI12260039	ARENOPOLIS	24/12/2020 20:40	25/12/2020 15:38	24/12/2020 20:40	25/12/2020 15:38	18,95	10	189,54	CHI
202012142296	AGUAS LINDAS DE GOIAS	LA12136550	AGUAS LINDAS DE GOIAS S1	24/12/2020 20:48	24/12/2020 23:28	24/12/2020 20:48	24/12/2020 23:28	2,67	724	1934,29	CHI
202012142141	CERES	RB12003204	RUBIATABA	24/12/2020 20:49	25/12/2020 07:03	24/12/2020 20:49	25/12/2020 07:03	10,23	2	20,46	CHI
202012142141	RUBIATABA	RB12003204	RUBIATABA	24/12/2020 20:49	25/12/2020 07:03	24/12/2020 20:49	25/12/2020 07:03	10,23	111	1135,28	CHI
202012142141	SAO PATRICIO	RB12003204	RUBIATABA	24/12/2020 20:49	25/12/2020 07:03	24/12/2020 20:49	25/12/2020 07:03	10,23	20	204,56	CHI
202012142141	CARMO DO RIO VERDE	RB12003204	RUBIATABA	24/12/2020 20:49	25/12/2020 07:03	24/12/2020 20:49	25/12/2020 07:03	10,23	3	30,68	CHI
202012142088	SANTA FE DE GOIAS	RN12378892	BRITANIA	24/12/2020 20:51	25/12/2020 19:52	24/12/2020 20:51	25/12/2020 19:52	23,02	19	437,30	CHI
202012142358	APARECIDA DE GOIANIA	200611264	CEPAIGO S1	24/12/2020 20:52	25/12/2020 00:36	24/12/2020 20:52	25/12/2020 00:36	3,74	1	3,74	CHI
202012142278	APARECIDA DE GOIANIA	AP12000209	INDEPENDENCIA S2	24/12/2020 20:59	24/12/2020 23:39	24/12/2020 20:59	24/12/2020 23:39	2,67	586	1562,83	CHI
202012142167	ANAPOLIS	AN11412736	DAIA S1	24/12/2020 21:12	25/12/2020 02:27	24/12/2020 21:12	25/12/2020 02:27	5,24	5	26,20	CHI
202012142207	APARECIDA DE GOIANIA	AP11426751	CEPAIGO S1	24/12/2020 21:22	25/12/2020 02:41	24/12/2020 21:22	25/12/2020 02:41	5,32	156	829,18	CHI
202012142259	FAINA	FC11220264	GOIAS	24/12/2020 21:31	25/12/2020 01:20	24/12/2020 21:31	25/12/2020 01:20	3,80	106	403,04	CHI
202012142334	SERRANOPOLIS	SX12166076	JATAI S1	24/12/2020 21:35	25/12/2020 08:07	24/12/2020 21:35	25/12/2020 08:07	10,52	11	115,75	CHI
202012142294	JANDAIA	JD12314915	PALMEIRAS	24/12/2020 21:41	25/12/2020 08:16	24/12/2020 21:41	25/12/2020 08:16	10,57	8	84,54	CHI
202012143022	JARAGUA	JA12221348	JARAGUA	24/12/2020 21:43	25/12/2020 15:30	24/12/2020 21:43	25/12/2020 15:30	17,78	7	124,44	CHI
202012142368	CACHOEIRA ALTA	CA12370046	CACHOEIRA ALTA	24/12/2020 21:45	25/12/2020 11:00	24/12/2020 21:45	25/12/2020 11:00	13,24	23	304,41	CHI
202012142339	FORMOSA	FA12030976	SAO JOAO D ALIANCA	24/12/2020 21:55	25/12/2020 09:41	24/12/2020 21:55	25/12/2020 09:41	11,76	3	35,29	CHI
202012142339	SAO JOAO D ALIANCA	FA12030976	SAO JOAO D ALIANCA	24/12/2020 21:55	25/12/2020 09:41	24/12/2020 21:55	25/12/2020 09:41	11,76	49	576,39	CHI
202012142361	ARAGARCAS	AG11354634	ARAGARCAS	24/12/2020 21:57	25/12/2020 08:30	24/12/2020 21:57	25/12/2020 08:30	10,55	84	886,36	CHI
202012142350	PIRACANJUBA	00320414	CALDAS NOVAS S1	24/12/2020 22:02	25/12/2020 13:43	24/12/2020 22:02	25/12/2020 00:31	2,49	7	17,45	CHI
202012142350	SANTA CRUZ DE GOIAS	00320414	CALDAS NOVAS S1	24/12/2020 22:02	25/12/2020 13:43	24/12/2020 22:02	25/12/2020 00:31	2,49	8	19,94	CHI
202012142350	CALDAS NOVAS	00320414	CALDAS NOVAS S1	24/12/2020 22:02	25/12/2020 13:43	24/12/2020 22:02	25/12/2020 00:31	2,49	43	107,19	CHI
202012142350	SANTA CRUZ DE GOIAS	PJ13000022	CALDAS NOVAS S1	24/12/2020 22:02	25/12/2020 13:43	24/12/2020 22:02	25/12/2020 03:03	5,02	1	5,02	CHI
202012142350	CALDAS NOVAS	PJ13000022	CALDAS NOVAS S1	24/12/2020 22:02	25/12/2020 13:43	24/12/2020 22:02	25/12/2020 03:03	5,02	5	25,12	CHI
202012142350	PIRACANJUBA	PJ13000022	CALDAS NOVAS S1	24/12/2020 22:02	25/12/2020 13:43	24/12/2020 22:02	25/12/2020 03:03	5,02	81	407,00	CHI
202012142350	PIRACANJUBA	PJ13000022	CALDAS NOVAS S1	24/12/2020 22:02	25/12/2020 13:43	24/12/2020 22:02	25/12/2020 03:03	5,02	173	869,28	CHI
202012142350	CALDAS NOVAS	PJ13000022	CALDAS NOVAS S1	24/12/2020 22:02	25/12/2020 13:43	24/12/2020 22:02	25/12/2020 03:03	5,02	1	5,02	CHI
202012142350	CALDAS NOVAS	CN13059926	CALDAS NOVAS S1	24/12/2020 22:02	25/12/2020 13:43	24/12/2020 22:02	25/12/2020 04:40	6,63	247	1637,95	CHI
202012142350	CALDAS NOVAS	CN13092049	CALDAS NOVAS S1	24/12/2020 22:02	25/12/2020 13:43	24/12/2020 22:02	25/12/2020 09:56	11,90	4	47,61	CHI
202012142350	CALDAS NOVAS	00320414	CALDAS NOVAS S1	24/12/2020 22:02	25/12/2020 13:43	25/12/2020 09:58	25/12/2020 10:14	0,26	290	76,85	CHI
202012142350	SANTA CRUZ DE GOIAS	00320414	CALDAS NOVAS S1	24/12/2020 22:02	25/12/2020 13:43	25/12/2020 09:58	25/12/2020 10:14	0,26	8	2,12	CHI
202012142350	PIRACANJUBA	00320414	CALDAS NOVAS S1	24/12/2020 22:02	25/12/2020 13:43	25/12/2020 09:58	25/12/2020 10:14	0,26	7	1,85	CHI
202012142350	CALDAS NOVAS	CN13092049	CALDAS NOVAS S1	24/12/2020 22:02	25/12/2020 13:43	25/12/2020 09:58	25/12/2020 13:21	3,39	4	13,54	CHI
202012142350	CALDAS NOVAS	CN13298616	CALDAS NOVAS S1	24/12/2020 22:02	25/12/2020 13:43	24/12/2020 22:02	25/12/2020 13:43	15,68	4	62,71	CHI
202012142350	PIRACANJUBA	CN13298616	CALDAS NOVAS S1	24/12/2020 22:02	25/12/2020 13:43	24/12/2020 22:02	25/12/2020 13:43	15,68	2	31,36	CHI
202012142356	MARA ROSA	MQ12263046	MARA ROSA	24/12/2020 22:11	25/12/2020 14:23	24/12/2020 22:11	25/12/2020 14:23	16,19	3	48,56	CHI
202012142356	MARA ROSA	MQ12263046	MARA ROSA	24/12/2020 22:11	25/12/2020 14:23	25/12/2020 12:54	25/12/2020 14:23	1,48	5	7,38	CHI
202012142357	RIO QUENTE	CN18414869TS	RIO QUENTE	24/12/2020 22:12	25/12/2020 04:06	24/12/2020 22:12	25/12/2020 04:06	5,90	2	11,81	CHI
202012142357	CALDAS NOVAS	CN18414869TS	RIO QUENTE	24/12/2020 22:12	25/12/2020 04:06	24/12/2020 22:12	25/12/2020 04:06	5,90	97	572,57	CHI
202012142357	MORRINHOS	CN18414869TS	RIO QUENTE	24/12/2020 22:12	25/12/2020 04:06	24/12/2020 22:12	25/12/2020 04:06	5,90	8	47,22	CHI



202012142357	PIRACANJUBA	CN18414869TS	RIO QUENTE	24/12/2020 22:12	25/12/2020 04:06	24/12/2020 22:12	25/12/2020 04:06	5,90	1	5,90	CHI
202012142440	GOIAS	NB12092962	MATRINCHA	24/12/2020 22:14	26/12/2020 13:29	24/12/2020 22:14	26/12/2020 13:29	39,24	3	117,73	CHI
202012142440	NOVO BRASIL	NB12092962	MATRINCHA	24/12/2020 22:14	26/12/2020 13:29	24/12/2020 22:14	26/12/2020 13:29	39,24	5	196,22	CHI
202012142440	ITAPIRAPUA	NB12092962	MATRINCHA	24/12/2020 22:14	26/12/2020 13:29	24/12/2020 22:14	26/12/2020 13:29	39,24	1	39,24	CHI
202012142363	CAMPO ALEGRE DE GOIAS	CM12156359	CAMPO ALEGRE DE GOIAS	24/12/2020 22:16	25/12/2020 00:21	24/12/2020 22:16	25/12/2020 00:21	2,07	31	64,32	CHI
202012142369	SAO MIGUEL DO ARAGUAIA	SM12349178	SAO MIGUEL DO ARAGUAIA	24/12/2020 22:17	25/12/2020 12:03	24/12/2020 22:17	25/12/2020 12:03	13,75	87	1196,42	CHI
202012142384	CORUMBAIBA	CI12041817	VILA CORUMBA	24/12/2020 22:28	25/12/2020 11:02	24/12/2020 22:28	25/12/2020 11:02	12,57	2	25,13	CHI
202012142391	JATAI	JT12000167RE	JATAI S1	24/12/2020 22:30	25/12/2020 21:07	24/12/2020 22:30	25/12/2020 21:07	22,62	25	565,53	CHI
202012142404	NOVO GAMA	NJ11097136	PACAEMBU S1	24/12/2020 22:35	25/12/2020 02:07	24/12/2020 22:35	25/12/2020 02:07	3,52	248	874,13	CHI
202012142632	ANAPOLIS	AN12321084	ANAPOLIS UNIVERSITARIO S1	24/12/2020 22:37	25/12/2020 09:25	24/12/2020 22:37	25/12/2020 09:25	10,80	7	75,59	CHI
202012142433	POSSE	O2620214	IACIARA S2	24/12/2020 22:48	25/12/2020 07:06	24/12/2020 22:48	24/12/2020 23:44	0,92	221	203,26	CHI
202012142433	POSSE	O2620214	IACIARA S2	24/12/2020 22:48	25/12/2020 07:06	25/12/2020 00:17	25/12/2020 00:26	0,14	221	30,76	CHI
202012142433	POSSE	PS12375578	IACIARA S2	24/12/2020 22:48	25/12/2020 07:06	25/12/2020 00:37	25/12/2020 01:11	0,58	1164	669,95	CHI
202012142433	POSSE	PS16394127	IACIARA S2	24/12/2020 22:48	25/12/2020 07:06	25/12/2020 00:37	25/12/2020 01:15	0,63	710	445,13	CHI
202012142433	POSSE	PS13000003	IACIARA S2	24/12/2020 22:48	25/12/2020 07:06	24/12/2020 22:48	25/12/2020 06:58	8,16	233	1901,41	CHI
202012142433	POSSE	PS13344278	IACIARA S2	24/12/2020 22:48	25/12/2020 07:06	24/12/2020 22:48	25/12/2020 07:02	8,22	1651	13574,89	CHI
202012142433	POSSE	PS10396924	IACIARA S2	24/12/2020 22:48	25/12/2020 07:06	25/12/2020 00:37	25/12/2020 07:06	6,49	4284	27790,07	CHI
202012142425	NOVO GAMA	NJ11163169	MARAJOARA	24/12/2020 22:49	25/12/2020 02:34	24/12/2020 22:49	25/12/2020 02:34	3,75	189	708,01	CHI
202012142429	JATAI	JT12172277LD	JATAI S2	24/12/2020 22:51	25/12/2020 09:41	24/12/2020 22:51	25/12/2020 09:41	10,83	2	21,66	CHI
202012142441	JATAI	JT18191724TS	JATAI S2	24/12/2020 22:56	25/12/2020 06:42	24/12/2020 22:56	25/12/2020 06:42	7,76	20	155,26	CHI
202012142444	TRINDADE	TR11071654	TRINDADE	24/12/2020 23:00	25/12/2020 01:48	24/12/2020 23:00	25/12/2020 01:48	2,79	62	173,08	CHI
202012142454	TRINDADE	TR13382713	TRINDADE	24/12/2020 23:03	25/12/2020 05:37	25/12/2020 03:28	25/12/2020 05:37	2,15	276	592,40	CHI
202012142479	GOIANIA	GN11001866	GOIANIA LESTE S2	24/12/2020 23:13	25/12/2020 00:35	24/12/2020 23:13	25/12/2020 00:35	1,36	128	174,01	CHI
202012142536	JANDAIA	JD12024301	PALMEIRAS	24/12/2020 23:15	25/12/2020 08:25	24/12/2020 23:15	25/12/2020 08:25	9,16	9	82,46	CHI
202012142470	SERRANOPOLIS	DJ12164060	CHAPADAO DO CEU	24/12/2020 23:21	25/12/2020 22:30	24/12/2020 23:21	25/12/2020 22:30	23,15	7	162,02	CHI
202012144850	SILVANIA	SV12043306	DAIA S2	24/12/2020 23:30	25/12/2020 15:35	24/12/2020 23:30	25/12/2020 15:35	16,07	56	900,12	CHI
202012142890	ALEXANIA	AX12384864	ALEXANIA	24/12/2020 23:37	25/12/2020 08:44	24/12/2020 23:37	25/12/2020 08:44	9,11	79	720,06	CHI
202012142496	FORMOSA	FA11257641	ITUIQUIRA	24/12/2020 23:38	25/12/2020 07:34	24/12/2020 23:38	25/12/2020 07:34	7,92	183	1449,77	CHI
202012142511	GOIANIA	GN10406701	GOYA S1	24/12/2020 23:42	26/12/2020 18:30	25/12/2020 00:44	25/12/2020 02:14	1,49	776	1158,83	CHI
202012142511	GOIANIA	GN13410510	GOYA S1	24/12/2020 23:42	26/12/2020 18:30	25/12/2020 00:44	25/12/2020 08:32	7,81	2	15,61	CHI
202012142511	GOIANIA	GN11218937	GOYA S1	24/12/2020 23:42	26/12/2020 18:30	24/12/2020 23:42	25/12/2020 23:20	23,62	62	1464,44	CHI
202012142511	GOIANIA	GN12189670	GOYA S1	24/12/2020 23:42	26/12/2020 18:30	25/12/2020 00:44	26/12/2020 18:30	41,76	1	41,76	CHI
202012142511	GOIANIA	GN12189670	GOYA S1	24/12/2020 23:42	26/12/2020 18:30	26/12/2020 15:26	26/12/2020 18:30	3,06	62	189,94	CHI
202012142510	PIRENOPOLIS	PV12062894	SAO FRANCISCO DE GOIAS	24/12/2020 23:49	25/12/2020 10:55	24/12/2020 23:49	25/12/2020 10:55	11,10	22	244,11	CHI
202012142510	PETROLINA DE GOIAS	PV12062894	SAO FRANCISCO DE GOIAS	24/12/2020 23:49	25/12/2020 10:55	24/12/2020 23:49	25/12/2020 10:55	11,10	3	33,29	CHI
202012142515	ALTO HORIZONTE	AJ12317686	SANTA TEREZINHA	24/12/2020 23:51	25/12/2020 08:15	24/12/2020 23:51	25/12/2020 08:15	8,39	1	8,39	CHI
202012142520	ALTO HORIZONTE	10001413196	SANTA TEREZINHA	24/12/2020 23:57	25/12/2020 12:01	24/12/2020 23:57	25/12/2020 12:01	12,07	1	12,07	CHI
202012142548	ORIZONA	2060008901	PIRES DO RIO S2	25/12/2020 00:24	25/12/2020 11:38	25/12/2020 00:24	25/12/2020 11:38	11,23	1	11,23	CHI
202012142584	AGUAS LINDAS DE GOIAS	LA12112902	AGUAS LINDAS DE GOIAS S2	25/12/2020 01:08	25/12/2020 02:18	25/12/2020 01:08	25/12/2020 02:18	1,16	740	856,14	CHI
202012142921	RUBIATABA	IW12215110RE	RUBIATABA	25/12/2020 01:13	25/12/2020 09:45	25/12/2020 01:13	25/12/2020 09:45	8,52	1	8,52	CHI
202012142921	NOVA AMERICA	IW12215110RE	RUBIATABA	25/12/2020 01:13	25/12/2020 09:45	25/12/2020 01:13	25/12/2020 09:45	8,52	11	93,74	CHI
202012142921	ITAPACI	IW12215110RE	RUBIATABA	25/12/2020 01:13	25/12/2020 09:45	25/12/2020 01:13	25/12/2020 09:45	8,52	54	460,17	CHI
202012143114	PILAR DE GOIAS	GG12181393	SANTA TEREZINHA	25/12/2020 01:21	25/12/2020 10:34	25/12/2020 01:21	25/12/2020 10:34	9,21	3	27,62	CHI
202012143114	SANTA TEREZINHA DE GOIAS	GG12181393	SANTA TEREZINHA	25/12/2020 01:21	25/12/2020 10:34	25/12/2020 01:21	25/12/2020 10:34	9,21	2	18,41	CHI
202012142618	GOIANIA	GN12269050	CARAJAS S2	25/12/2020 01:24	25/12/2020 03:27	25/12/2020 01:24	25/12/2020 03:27	2,04	366	747,05	CHI
202012143218	ITAGUARI	IC18219941TS	ITABERAI S1	25/12/2020 01:25	25/12/2020 08:21	25/12/2020 01:25	25/12/2020 08:21	6,93	29	201,00	CHI
202012143218	ITAGUARU	IC18219941TS	ITABERAI S1	25/12/2020 01:25	25/12/2020 08:21	25/12/2020 01:25	25/12/2020 08:21	6,93	20	138,62	CHI
202012142592	ARUANA	AK16431377	ARUANA	25/12/2020 01:28	25/12/2020 12:59	25/12/2020 06:46	25/12/2020 07:26	0,65	531	346,03	CHI
202012142592	ARUANA	AK16410163	ARUANA	25/12/2020 01:28	25/12/2020 12:59	25/12/2020 07:07	25/12/2020 12:59	5,88	254	1493,24	CHI
202012142594	MIMOSO DE GOIAS	MU12249518	PADRE BERNARDO	25/12/2020 01:33	25/12/2020 08:49	25/12/2020 01:33	25/12/2020 08:49	7,26	49	355,75	CHI
202012143990	ORIZONA	OZ12300550	PIRES DO RIO S2	25/12/2020 01:39	25/12/2020 11:43	25/12/2020 01:39	25/12/2020 11:43	10,05	53	532,89	CHI

202012143498	FAZENDA NOVA	FN12060710	IPORA	25/12/2020 01:46	25/12/2020 09:56	25/12/2020 01:46	25/12/2020 09:56	8,16	48	391,67	CHI
202012179397	JUSSARA	JR12267250	JUSSARA	25/12/2020 01:51	25/12/2020 08:15	25/12/2020 01:51	25/12/2020 08:15	6,39	98	626,55	CHI
202012142612	CABECEIRAS	CW12046855	ITUIQUIRA	25/12/2020 01:57	25/12/2020 14:38	25/12/2020 01:57	25/12/2020 14:38	12,68	163	2066,21	CHI
202012143024	PORANGATU	PO12282160	PORANGATU	25/12/2020 02:04	26/12/2020 11:55	25/12/2020 02:04	26/12/2020 11:55	33,85	11	372,30	CHI
202012142621	ANICUNS	NZ12259104	ANICUNS	25/12/2020 02:05	25/12/2020 07:48	25/12/2020 02:05	25/12/2020 07:48	5,71	34	193,99	CHI
202012142621	NAZARIO	NZ12259104	ANICUNS	25/12/2020 02:05	25/12/2020 07:48	25/12/2020 02:05	25/12/2020 07:48	5,71	3	17,12	CHI
202012142625	TURVANIA	TV12299185	ANICUNS	25/12/2020 02:09	25/12/2020 04:02	25/12/2020 02:09	25/12/2020 04:02	1,87	4	7,48	CHI
202012142633	URUACU	UR12000054RE	CAMPINORTE	25/12/2020 02:14	25/12/2020 05:46	25/12/2020 02:14	25/12/2020 05:46	3,52	93	327,44	CHI
202012142633	NOVA IGUACU DE GOIAS	UR12000054RE	CAMPINORTE	25/12/2020 02:14	25/12/2020 05:46	25/12/2020 02:14	25/12/2020 05:46	3,52	15	52,81	CHI
202012142636	FORMOSO	FO21065538	PORANGATU	25/12/2020 02:18	25/12/2020 05:22	25/12/2020 02:18	25/12/2020 05:22	3,05	1	3,05	CHI
202012144123	JUSSARA	JR12022269RE	BRITANIA	25/12/2020 02:19	26/12/2020 09:00	25/12/2020 02:19	25/12/2020 16:25	14,10	8	112,80	CHI
202012144123	MONTES CLAROS DE GOIAS	JR12022269RE	BRITANIA	25/12/2020 02:19	26/12/2020 09:00	25/12/2020 02:19	25/12/2020 17:18	14,98	1	14,98	CHI
202012144123	JUSSARA	JR12022269RE	BRITANIA	25/12/2020 02:19	26/12/2020 09:00	25/12/2020 02:19	25/12/2020 17:18	14,98	22	329,63	CHI
202012144123	JUSSARA	JR12022269RE	BRITANIA	25/12/2020 02:19	26/12/2020 09:00	25/12/2020 17:41	25/12/2020 19:06	1,41	5	7,04	CHI
202012144123	MONTES CLAROS DE GOIAS	JR12022269RE	BRITANIA	25/12/2020 02:19	26/12/2020 09:00	25/12/2020 17:41	25/12/2020 19:39	1,96	1	1,96	CHI
202012144123	JUSSARA	JR12022269RE	BRITANIA	25/12/2020 02:19	26/12/2020 09:00	25/12/2020 17:41	25/12/2020 19:39	1,96	11	21,61	CHI
202012144123	MONTES CLAROS DE GOIAS	JR12022269RE	BRITANIA	25/12/2020 02:19	26/12/2020 09:00	25/12/2020 02:19	25/12/2020 20:02	17,72	3	53,15	CHI
202012144123	MONTES CLAROS DE GOIAS	JR12022269RE	BRITANIA	25/12/2020 02:19	26/12/2020 09:00	25/12/2020 02:19	25/12/2020 21:54	19,58	11	215,42	CHI
202012144123	MONTES CLAROS DE GOIAS	JR12022269RE	BRITANIA	25/12/2020 02:19	26/12/2020 09:00	25/12/2020 02:19	25/12/2020 22:47	20,46	255	5216,17	CHI
202012144123	JUSSARA	JR12022269RE	BRITANIA	25/12/2020 02:19	26/12/2020 09:00	25/12/2020 17:41	26/12/2020 09:00	15,31	2	30,62	CHI
202012144123	JUSSARA	JR12038166	BRITANIA	25/12/2020 02:19	26/12/2020 09:00	25/12/2020 19:18	26/12/2020 09:00	13,68	3	41,05	CHI
202012142642	APARECIDA DE GOIANIA	AP11196604	ANHANGUERA	25/12/2020 02:28	25/12/2020 14:41	25/12/2020 02:28	25/12/2020 14:41	12,22	158	1931,29	CHI
202012142646	CRISTALINA	KR12313551	CRISTALINA S2	25/12/2020 02:34	25/12/2020 11:27	25/12/2020 02:34	25/12/2020 11:27	8,88	95	843,57	CHI
202012143242	PIRENOPOLIS	PV12185533	COCALZINHO	25/12/2020 02:35	25/12/2020 09:58	25/12/2020 02:35	25/12/2020 09:58	7,38	20	147,67	CHI
202012143242	COCALZINHO DE GOIAS	PV12185533	COCALZINHO	25/12/2020 02:35	25/12/2020 09:58	25/12/2020 02:35	25/12/2020 09:58	7,38	1	7,38	CHI
202012143509	MINEIROS	MY12303394	PARQUE DAS EMAS	25/12/2020 02:39	25/12/2020 11:56	25/12/2020 02:39	25/12/2020 11:56	9,27	19	176,11	CHI
202012142654	ALTO HORIZONTE	AJ12320992RE	SANTA TEREZINHA	25/12/2020 02:42	25/12/2020 09:03	25/12/2020 02:42	25/12/2020 09:03	6,35	47	298,29	CHI
202012142657	TRINDADE	TR11240503	TRINDADE	25/12/2020 02:46	25/12/2020 07:09	25/12/2020 02:46	25/12/2020 07:09	4,39	24	105,33	CHI
202012142786	SANCLERLANDIA	SL18323580TS	SAO LUIZ DOS MONTES BELOS	25/12/2020 02:48	25/12/2020 07:33	25/12/2020 02:48	25/12/2020 07:33	4,74	27	127,87	CHI
202012142786	SAO LUIS DE MONTES BELOS	SL18323580TS	SAO LUIZ DOS MONTES BELOS	25/12/2020 02:48	25/12/2020 07:33	25/12/2020 02:48	25/12/2020 07:33	4,74	113	535,15	CHI
202012142702	GOIANESIA	GE12384153	GOIANESIA S2	25/12/2020 02:54	25/12/2020 21:30	25/12/2020 02:54	25/12/2020 21:30	18,60	9	167,40	CHI
202012142668	DAMIANOPOLIS	MB12180672	IACIARA S2	25/12/2020 03:00	25/12/2020 08:56	25/12/2020 03:00	25/12/2020 08:56	5,93	9	53,40	CHI
202012142671	CACHOEIRA ALTA	CA21134892	CACHOEIRA ALTA	25/12/2020 03:10	25/12/2020 08:57	25/12/2020 03:10	25/12/2020 08:57	5,77	1	5,77	CHI
202012142916	QUIRINOPOLIS	QI32017987	QUIRINOPOLIS	25/12/2020 03:13	25/12/2020 09:36	25/12/2020 03:13	25/12/2020 09:36	6,37	11	70,05	CHI
202012142675	CROMINIA	CQ12000245	PONTALINA	25/12/2020 03:14	25/12/2020 07:33	25/12/2020 03:14	25/12/2020 07:33	4,31	9	38,78	CHI
202012143010	CACU	CC12191701	CACHOEIRA ALTA	25/12/2020 03:14	25/12/2020 11:36	25/12/2020 03:14	25/12/2020 11:36	8,37	86	719,49	CHI
202012142676	PONTALINA	PK11142465	PONTALINA	25/12/2020 03:15	25/12/2020 07:45	25/12/2020 03:15	25/12/2020 07:45	4,48	139	623,41	CHI
202012142680	AURILANDIA	AI12000002	FIRMINOPOLIS S2	25/12/2020 03:17	25/12/2020 06:51	25/12/2020 03:17	25/12/2020 06:51	3,55	30	106,52	CHI
202012142680	FIRMINOPOLIS	AI12000002	FIRMINOPOLIS S2	25/12/2020 03:17	25/12/2020 06:51	25/12/2020 03:17	25/12/2020 06:51	3,55	16	56,81	CHI
202012143183	QUIRINOPOLIS	QI18271537TS	QUIRINOPOLIS	25/12/2020 03:17	25/12/2020 08:21	25/12/2020 03:17	25/12/2020 08:21	5,07	93	471,23	CHI
202012143372	GAMELEIRA DE GOIAS	LB12000008	DAIA S2	25/12/2020 03:17	25/12/2020 08:34	25/12/2020 03:17	25/12/2020 08:34	5,28	16	84,44	CHI
202012143372	SILVANIA	LB12000008	DAIA S2	25/12/2020 03:17	25/12/2020 08:34	25/12/2020 03:17	25/12/2020 08:34	5,28	98	517,19	CHI
202012143372	LEOPOLDO DE BULHOES	LB12000008	DAIA S2	25/12/2020 03:17	25/12/2020 08:34	25/12/2020 03:17	25/12/2020 08:34	5,28	161	849,68	CHI
202012142980	ITAGUARI	JA12063000	ITABERAI S1	25/12/2020 03:20	25/12/2020 10:40	25/12/2020 03:20	25/12/2020 10:40	7,32	6	43,91	CHI
202012142980	JARAGUA	JA12063000	ITABERAI S1	25/12/2020 03:20	25/12/2020 10:40	25/12/2020 03:20	25/12/2020 10:40	7,32	17	124,42	CHI
202012142980	ITAGUARU	JA12063000	ITABERAI S1	25/12/2020 03:20	25/12/2020 10:40	25/12/2020 03:20	25/12/2020 10:40	7,32	3	21,96	CHI
202012142686	SAO LUIS DE MONTES BELOS	SL12111561	FIRMINOPOLIS S1	25/12/2020 03:21	25/12/2020 04:38	25/12/2020 03:21	25/12/2020 04:38	1,28	3	3,83	CHI
202012142686	FIRMINOPOLIS	SL12111561	FIRMINOPOLIS S1	25/12/2020 03:21	25/12/2020 04:38	25/12/2020 03:21	25/12/2020 04:38	1,28	6	7,66	CHI
202012143002	SANTA CRUZ DE GOIAS	BC12023183	CRISTIANOPOLIS	25/12/2020 03:34	25/12/2020 08:29	25/12/2020 03:34	25/12/2020 08:29	4,92	42	206,48	CHI
202012142695	QUIRINOPOLIS	QI32047434	QUIRINOPOLIS	25/12/2020 03:36	25/12/2020 11:22	25/12/2020 03:36	25/12/2020 11:22	7,76	1	7,76	CHI
202012142698	MINACU	IH12392289	MINACU	25/12/2020 03:38	25/12/2020 09:58	25/12/2020 03:38	25/12/2020 09:58	6,32	10	63,25	CHI

202012142699	CALDAZINHA	BV12059732	SENADOR CANEDO	25/12/2020 03:41	25/12/2020 08:42	25/12/2020 03:41	25/12/2020 08:42	5,01	8	40,10	CHI
202012142699	BELA VISTA DE GOIAS	BV12059732	SENADOR CANEDO	25/12/2020 03:41	25/12/2020 08:42	25/12/2020 03:41	25/12/2020 08:42	5,01	5	25,06	CHI
202012142700	EDEIA	EA12000048	EDEIA	25/12/2020 03:41	25/12/2020 08:56	25/12/2020 03:41	25/12/2020 08:56	5,24	32	167,66	CHI
202012143041	AMORINOPOLIS	IR12091436	IPORA	25/12/2020 03:42	25/12/2020 09:35	25/12/2020 03:42	25/12/2020 09:35	5,88	3	17,64	CHI
202012143041	IPORA	IR12091436	IPORA	25/12/2020 03:42	25/12/2020 09:35	25/12/2020 03:42	25/12/2020 09:35	5,88	16	94,08	CHI
202012142820	NIQUELANDIA	BA12035658	BARRO ALTO	25/12/2020 03:45	25/12/2020 09:01	25/12/2020 03:45	25/12/2020 09:01	5,26	4	21,03	CHI
202012142820	BARRO ALTO	BA12035658	BARRO ALTO	25/12/2020 03:45	25/12/2020 09:01	25/12/2020 03:45	25/12/2020 09:01	5,26	14	73,59	CHI
202012142704	CUMARI	CY12027445	CATALAO S1	25/12/2020 03:46	25/12/2020 08:45	25/12/2020 03:46	25/12/2020 08:45	4,98	4	19,92	CHI
202012142819	JOVIANIA	JV12000001	GOIATUBA S1	25/12/2020 03:46	25/12/2020 06:59	25/12/2020 03:46	25/12/2020 06:59	3,20	97	310,86	CHI
202012142819	PONTALINA	JV12000001	GOIATUBA S1	25/12/2020 03:46	25/12/2020 06:59	25/12/2020 03:46	25/12/2020 06:59	3,20	16	51,28	CHI
202012142925	RIO VERDE	RV12026916	RIO DOS BOIS	25/12/2020 03:49	25/12/2020 09:56	25/12/2020 03:49	25/12/2020 09:56	6,11	2	12,21	CHI
202012142925	CASTELANDIA	RV12026916	RIO DOS BOIS	25/12/2020 03:49	25/12/2020 09:56	25/12/2020 03:49	25/12/2020 09:56	6,11	12	73,27	CHI
202012142708	GOIAS	IK12274567	GOIAS	25/12/2020 03:53	25/12/2020 07:53	25/12/2020 03:53	25/12/2020 07:53	4,00	5	20,00	CHI
202012142711	BOM JARDIM DE GOIAS	BM12065725	BOM JARDIM	25/12/2020 03:57	25/12/2020 08:03	25/12/2020 03:57	25/12/2020 08:03	4,10	100	410,00	CHI
202012142711	PIRANHAS	BM12065725	BOM JARDIM	25/12/2020 03:57	25/12/2020 08:03	25/12/2020 03:57	25/12/2020 08:03	4,10	8	32,80	CHI
202012142750	PARANAIGUARA	PC12271552	QUIRINOPOLIS	25/12/2020 04:06	25/12/2020 11:05	25/12/2020 04:06	25/12/2020 11:05	6,98	12	83,72	CHI
202012142750	QUIRINOPOLIS	PC12271552	QUIRINOPOLIS	25/12/2020 04:06	25/12/2020 11:05	25/12/2020 04:06	25/12/2020 11:05	6,98	25	174,41	CHI
202012142866	GOIATUBA	GT12044851	GOIATUBA S2	25/12/2020 04:06	25/12/2020 09:30	25/12/2020 04:06	25/12/2020 09:30	5,39	10	53,85	CHI
202012142853	ITAPACI	6800546	ITAPACI	25/12/2020 04:08	25/12/2020 07:40	25/12/2020 04:08	25/12/2020 07:40	3,52	107	377,15	CHI
202012142853	GUARINOS	6800546	ITAPACI	25/12/2020 04:08	25/12/2020 07:40	25/12/2020 04:08	25/12/2020 07:40	3,52	20	70,49	CHI
202012142718	GUAPO	GA12000026	GUAPO S1	25/12/2020 04:09	25/12/2020 08:55	25/12/2020 04:09	25/12/2020 08:55	4,76	5	23,78	CHI
202012142758	ITAGUARU	IC12219937	ITABERAI S1	25/12/2020 04:11	25/12/2020 07:24	25/12/2020 04:11	25/12/2020 07:24	3,20	2	6,41	CHI
202012142758	ITAGUARI	IC12219937	ITABERAI S1	25/12/2020 04:11	25/12/2020 07:24	25/12/2020 04:11	25/12/2020 07:24	3,20	25	80,06	CHI
202012142724	FAINA	FC10395387	GOIAS	25/12/2020 04:14	25/12/2020 04:32	25/12/2020 04:14	25/12/2020 04:18	0,06	66	3,70	CHI
202012142724	ARAGUAPAZ	FC10395387	GOIAS	25/12/2020 04:14	25/12/2020 04:32	25/12/2020 04:14	25/12/2020 04:18	0,06	123	6,90	CHI
202012142724	ARAGUAPAZ	FC16410222	GOIAS	25/12/2020 04:14	25/12/2020 04:32	25/12/2020 04:21	25/12/2020 04:32	0,18	125	22,74	CHI
202012142724	FAINA	FC16410222	GOIAS	25/12/2020 04:14	25/12/2020 04:32	25/12/2020 04:21	25/12/2020 04:32	0,18	199	36,21	CHI
202012142723	ITAPIRAPUA	IU12142895	MATRINCHA	25/12/2020 04:17	25/12/2020 11:00	25/12/2020 04:17	25/12/2020 11:00	6,70	8	53,62	CHI
202012142725	JUSSARA	JR12019314	JUSSARA	25/12/2020 04:19	25/12/2020 10:45	25/12/2020 04:19	25/12/2020 10:45	6,44	83	534,34	CHI
202012142727	CORUMBAIBA	CI12153433	VILA CORUMBA	25/12/2020 04:20	25/12/2020 10:24	25/12/2020 04:20	25/12/2020 10:24	6,06	1	6,06	CHI
202012142729	INDIARA	IY12158916	CEZARINA	25/12/2020 04:22	25/12/2020 08:00	25/12/2020 04:22	25/12/2020 08:00	3,62	3	10,86	CHI
202012142734	ARAGARCAS	BM12204856LD	BOM JARDIM	25/12/2020 04:22	25/12/2020 10:47	25/12/2020 04:22	25/12/2020 10:47	6,41	24	153,80	CHI
202012142734	BALIZA	BM12204856LD	BOM JARDIM	25/12/2020 04:22	25/12/2020 10:47	25/12/2020 04:22	25/12/2020 10:47	6,41	53	339,64	CHI
202012144164	CORUMBAIBA	CI12000486	VILA CORUMBA	25/12/2020 04:25	25/12/2020 15:35	25/12/2020 04:25	25/12/2020 15:35	11,16	4	44,64	CHI
202012142771	SAO MIGUEL DO PASSA QUATRO	BV12272141	BELA VISTA S2	25/12/2020 04:32	25/12/2020 09:25	25/12/2020 04:32	25/12/2020 09:25	4,87	91	443,50	CHI
202012142771	BELA VISTA DE GOIAS	BV12272141	BELA VISTA S2	25/12/2020 04:32	25/12/2020 09:25	25/12/2020 04:32	25/12/2020 09:25	4,87	33	160,83	CHI
202012142737	MAURILANDIA	DM12000064	RIO DOS BOIS	25/12/2020 04:36	25/12/2020 09:34	25/12/2020 04:36	25/12/2020 09:34	4,96	1	4,96	CHI
202012142737	CASTELANDIA	DM12000064	RIO DOS BOIS	25/12/2020 04:36	25/12/2020 09:34	25/12/2020 04:36	25/12/2020 09:34	4,96	10	49,64	CHI
202012142801	MUNDO NOVO DE GOIAS	NA12035650	NOVA CRIXAS	25/12/2020 04:40	25/12/2020 10:25	25/12/2020 04:40	25/12/2020 10:25	5,74	8	45,91	CHI
202012142801	NOVA CRIXAS	NA12035650	NOVA CRIXAS	25/12/2020 04:40	25/12/2020 10:25	25/12/2020 04:40	25/12/2020 10:25	5,74	24	137,72	CHI
202012142846	CACHOEIRA DE GOIAS	CG12289761	FIRMINOPOLIS S2	25/12/2020 04:50	25/12/2020 08:14	25/12/2020 04:50	25/12/2020 08:14	3,38	18	60,93	CHI
202012142796	CORUMBAIBA	NE12037329LD	CATALAO S1	25/12/2020 04:51	25/12/2020 08:43	25/12/2020 04:51	25/12/2020 08:43	3,85	15	57,80	CHI
202012142796	NOVA AURORA	NE12037329LD	CATALAO S1	25/12/2020 04:51	25/12/2020 08:43	25/12/2020 04:51	25/12/2020 08:43	3,85	60	231,22	CHI
202012142978	AMARALINA	LC12189854	MARA ROSA	25/12/2020 04:51	25/12/2020 10:09	25/12/2020 04:51	25/12/2020 10:09	5,28	8	42,28	CHI
202012142978	MARA ROSA	LC12189854	MARA ROSA	25/12/2020 04:51	25/12/2020 10:09	25/12/2020 04:51	25/12/2020 10:09	5,28	2	10,57	CHI
202012142755	LUZIANIA	LZ11090128	RIO VERMELHO	25/12/2020 04:53	25/12/2020 07:06	25/12/2020 04:53	25/12/2020 07:06	2,21	162	357,48	CHI
202012142757	CROMINIA	MI12120716	PONTALINA	25/12/2020 04:54	25/12/2020 08:41	25/12/2020 04:54	25/12/2020 08:41	3,78	1	3,78	CHI
202012142757	MAIRIPOTABA	MI12120716	PONTALINA	25/12/2020 04:54	25/12/2020 08:41	25/12/2020 04:54	25/12/2020 08:41	3,78	8	30,22	CHI
202012142926	RIO VERDE	RV12104444LD	RIO VERDE S1	25/12/2020 04:54	25/12/2020 08:31	25/12/2020 04:54	25/12/2020 08:31	3,62	78	281,99	CHI
202012142976	JARAGUA	JA12059976	JARAGUA	25/12/2020 04:56	25/12/2020 08:40	25/12/2020 04:56	25/12/2020 08:40	3,73	2	7,45	CHI
202012142976	PIRENOPOLIS	JA12059976	JARAGUA	25/12/2020 04:56	25/12/2020 08:40	25/12/2020 04:56	25/12/2020 08:40	3,73	97	361,49	CHI

202012142809	DOVERLANDIA	DV12332038	CAIAPONIA	25/12/2020 05:05	25/12/2020 08:31	25/12/2020 05:05	25/12/2020 08:31	3,42	29	99,17	CHI
202012142809	CAIAPONIA	DV12332038	CAIAPONIA	25/12/2020 05:05	25/12/2020 08:31	25/12/2020 05:05	25/12/2020 08:31	3,42	23	78,65	CHI
202012143076	DOVERLANDIA	DV12138335	CAIAPONIA	25/12/2020 05:08	25/12/2020 11:20	25/12/2020 05:08	25/12/2020 11:20	6,20	37	229,25	CHI
202012142826	MOZARLANDIA	MZ12055628	MOZARLANDIA	25/12/2020 05:09	25/12/2020 07:45	25/12/2020 05:09	25/12/2020 07:45	2,59	40	103,67	CHI
202012142826	CRIXAS	MZ12055628	MOZARLANDIA	25/12/2020 05:09	25/12/2020 07:45	25/12/2020 05:09	25/12/2020 07:45	2,59	26	67,38	CHI
202012143001	CALDAS NOVAS	CN12363792	SERRA DE CALDAS	25/12/2020 05:09	25/12/2020 08:54	25/12/2020 05:09	25/12/2020 08:53	3,73	2	7,46	CHI
202012143001	CALDAS NOVAS	CN12363792	SERRA DE CALDAS	25/12/2020 05:09	25/12/2020 08:54	25/12/2020 05:09	25/12/2020 08:54	3,74	130	485,98	CHI
202012142770	MUTUNOPOLIS	MU12391658	MARA ROSA	25/12/2020 05:10	25/12/2020 08:22	25/12/2020 05:10	25/12/2020 08:22	3,20	34	108,78	CHI
202012142839	SAO JOAO D ALIANCA	FB12248238	FLORES DE GOIAS	25/12/2020 05:12	25/12/2020 08:55	25/12/2020 05:12	25/12/2020 08:55	3,70	40	148,18	CHI
202012142839	FLORES DE GOIAS	FB12248238	FLORES DE GOIAS	25/12/2020 05:12	25/12/2020 08:55	25/12/2020 05:12	25/12/2020 08:55	3,70	101	374,15	CHI
202012142775	PORANGATU	PO12321067	NOVO PLANALTO	25/12/2020 05:13	25/12/2020 10:41	25/12/2020 05:13	25/12/2020 10:41	5,46	3	16,39	CHI
202012142776	CAMPOS VERDES	VD12257347	SANTA TEREZINHA	25/12/2020 05:13	25/12/2020 08:39	25/12/2020 05:13	25/12/2020 08:39	3,43	3	10,28	CHI
202012143190	QUIRINOPOLIS	QI12279582	QUIRINOPOLIS	25/12/2020 05:18	25/12/2020 09:25	25/12/2020 05:18	25/12/2020 09:25	4,11	14	57,54	CHI
202012142790	PADRE BERNARDO	PB12382934	PADRE BERNARDO	25/12/2020 05:21	25/12/2020 09:56	25/12/2020 05:21	25/12/2020 09:56	4,57	4	18,28	CHI
202012143690	NIQUELANDIA	NQ12268729	BARRO ALTO	25/12/2020 05:22	25/12/2020 11:22	25/12/2020 05:22	25/12/2020 11:22	5,99	63	377,51	CHI
202012143080	EDEIA	EA12000039	EDEIA	25/12/2020 05:23	25/12/2020 10:05	25/12/2020 05:23	25/12/2020 10:05	4,69	23	107,84	CHI
202012144130	FAZENDA NOVA	FN12354616	BRITANIA	25/12/2020 05:30	25/12/2020 13:52	25/12/2020 05:30	25/12/2020 13:52	8,36	45	376,11	CHI
202012144130	JUSSARA	FN12354616	BRITANIA	25/12/2020 05:30	25/12/2020 13:52	25/12/2020 05:30	25/12/2020 13:52	8,36	11	91,94	CHI
202012142805	ITAUCU	IX12413195	INHUMAS S1	25/12/2020 05:33	25/12/2020 11:07	25/12/2020 05:33	25/12/2020 11:07	5,56	3	16,68	CHI
202012142805	ITABERAI	IX12413195	INHUMAS S1	25/12/2020 05:33	25/12/2020 11:07	25/12/2020 05:33	25/12/2020 11:07	5,56	1	5,56	CHI
202012142807	QUIRINOPOLIS	QI12273812	QUIRINOPOLIS	25/12/2020 05:33	25/12/2020 09:39	25/12/2020 05:33	25/12/2020 09:39	4,09	7	28,62	CHI
202012142818	SANTO ANTONIO DA BARRA	O1690214	ACREUNA	25/12/2020 05:33	25/12/2020 12:35	25/12/2020 05:33	25/12/2020 08:21	2,80	1476	4136,90	CHI
202012142818	SANTO ANTONIO DA BARRA	O1690214	ACREUNA	25/12/2020 05:33	25/12/2020 12:35	25/12/2020 09:13	25/12/2020 09:23	0,17	1476	245,59	CHI
202012142818	SANTO ANTONIO DA BARRA	O1690214	ACREUNA	25/12/2020 05:33	25/12/2020 12:35	25/12/2020 05:33	25/12/2020 10:04	4,51	201	907,12	CHI
202012142818	PARAUNA	O1690214	ACREUNA	25/12/2020 05:33	25/12/2020 12:35	25/12/2020 05:33	25/12/2020 10:04	4,51	166	749,17	CHI
202012142818	RIO VERDE	O1690214	ACREUNA	25/12/2020 05:33	25/12/2020 12:35	25/12/2020 05:33	25/12/2020 10:04	4,51	140	631,83	CHI
202012142818	SANTO ANTONIO DA BARRA	BZ13000001	ACREUNA	25/12/2020 05:33	25/12/2020 12:35	25/12/2020 07:42	25/12/2020 10:04	2,37	2	4,74	CHI
202012142818	SANTO ANTONIO DA BARRA	O1690214	ACREUNA	25/12/2020 05:33	25/12/2020 12:35	25/12/2020 05:33	25/12/2020 12:35	7,04	1	7,04	CHI
202012142818	SANTO ANTONIO DA BARRA	BZ12200723LD	ACREUNA	25/12/2020 05:33	25/12/2020 12:35	25/12/2020 10:30	25/12/2020 12:35	2,08	127	264,05	CHI
202012142818	PARAUNA	BZ12200723LD	ACREUNA	25/12/2020 05:33	25/12/2020 12:35	25/12/2020 10:30	25/12/2020 12:35	2,08	166	345,14	CHI
202012142818	RIO VERDE	BZ12200723LD	ACREUNA	25/12/2020 05:33	25/12/2020 12:35	25/12/2020 10:30	25/12/2020 12:35	2,08	140	291,08	CHI
202012143239	BELA VISTA DE GOIAS	BV12009000	BELA VISTA S2	25/12/2020 05:33	25/12/2020 10:22	25/12/2020 05:33	25/12/2020 10:22	4,80	56	268,82	CHI
202012142814	GOIAS	GS12087829	ITABERAI S1	25/12/2020 05:35	25/12/2020 07:42	25/12/2020 05:35	25/12/2020 07:42	2,10	4	8,42	CHI
202012142822	CAVALCANTE	CJ12308271	MINACU	25/12/2020 05:36	25/12/2020 14:15	25/12/2020 05:36	25/12/2020 14:15	8,63	2	17,27	CHI
202012142821	BELA VISTA DE GOIAS	BV12082045RE	CRISTIANOPOLIS	25/12/2020 05:38	25/12/2020 07:03	25/12/2020 05:38	25/12/2020 07:03	1,41	4	5,64	CHI
202012142821	CRISTIANOPOLIS	BV12082045RE	CRISTIANOPOLIS	25/12/2020 05:38	25/12/2020 07:03	25/12/2020 05:38	25/12/2020 07:03	1,41	21	29,62	CHI
202012143284	SERRANOPOLIS	SX12296514	JATAI S1	25/12/2020 05:40	25/12/2020 15:25	25/12/2020 05:40	25/12/2020 15:25	9,75	23	224,17	CHI
202012143312	LEOPOLDO DE BULHOES	AN12258710	JUNDIAI S1	25/12/2020 05:40	25/12/2020 09:59	25/12/2020 05:40	25/12/2020 09:59	4,31	2	8,62	CHI
202012142892	ACREUNA	EU12260931	ACREUNA	25/12/2020 05:42	25/12/2020 07:50	25/12/2020 05:42	25/12/2020 07:50	2,12	3	6,36	CHI
202012142831	AGUAS LINDAS DE GOIAS	LA11149773	AGUAS LINDAS DE GOIAS S1	25/12/2020 05:44	25/12/2020 08:18	25/12/2020 05:44	25/12/2020 08:18	2,55	93	237,20	CHI
202012142834	MOZARLANDIA	MZ12055636	MOZARLANDIA	25/12/2020 05:45	25/12/2020 10:13	25/12/2020 05:45	25/12/2020 10:13	4,45	3	13,36	CHI
202012144904	MINEIROS	MY12000088	PARQUE DAS EMAS	25/12/2020 05:46	25/12/2020 16:22	25/12/2020 05:46	25/12/2020 16:22	10,60	8	84,78	CHI
202012142837	BONOPOLIS	BX12334597	NOVO PLANALTO	25/12/2020 05:47	26/12/2020 04:01	25/12/2020 05:47	26/12/2020 04:01	22,23	3	66,69	CHI
202012143321	VILA PROPICIO	GE12357342	GOIANESIA S2	25/12/2020 05:47	25/12/2020 09:34	25/12/2020 05:47	25/12/2020 09:34	3,78	9	34,01	CHI
202012143321	GOIANESIA	GE12357342	GOIANESIA S2	25/12/2020 05:47	25/12/2020 09:34	25/12/2020 05:47	25/12/2020 09:34	3,78	19	71,79	CHI
202012142840	GOIAS	HE12300124	ITAPURANGA	25/12/2020 05:48	25/12/2020 08:41	25/12/2020 05:48	25/12/2020 08:41	2,88	10	28,77	CHI
202012142840	HEITORAI	HE12300124	ITAPURANGA	25/12/2020 05:48	25/12/2020 08:41	25/12/2020 05:48	25/12/2020 08:41	2,88	6	17,26	CHI
202012142844	AMARALINA	LC12270742	SAO MIGUEL DO ARAGUAIA	25/12/2020 05:49	25/12/2020 11:35	25/12/2020 05:49	25/12/2020 11:35	5,75	4	23,01	CHI
202012143188	ITAPIRAPUA	IU12089755	MATRINCHA	25/12/2020 05:49	25/12/2020 10:09	25/12/2020 05:49	25/12/2020 10:09	4,33	56	242,25	CHI
202012143188	GOIAS	IU12089755	MATRINCHA	25/12/2020 05:49	25/12/2020 10:09	25/12/2020 05:49	25/12/2020 10:09	4,33	1	4,33	CHI
202012142988	RUBIATABA	RB12022187	ITAPURANGA	25/12/2020 05:50	25/12/2020 10:45	25/12/2020 05:50	25/12/2020 10:45	4,91	9	44,15	CHI

202012142988	ARAGUAPAZ	RB12022187	ITAPURANGA	25/12/2020 05:50	25/12/2020 10:45	25/12/2020 05:50	25/12/2020 10:45	4,91	1	4,91	CHI
202012142988	MORRO AGUDO DE GOIAS	RB12022187	ITAPURANGA	25/12/2020 05:50	25/12/2020 10:45	25/12/2020 05:50	25/12/2020 10:45	4,91	1	4,91	CHI
202012143582	ITUMBIARA	IT12033777	CACHOEIRA DOURADA	25/12/2020 05:52	25/12/2020 10:40	25/12/2020 05:52	25/12/2020 10:40	4,80	13	62,40	CHI
202012143376	PORANGATU	PO12104347	PORANGATU	25/12/2020 05:55	25/12/2020 09:21	25/12/2020 05:55	25/12/2020 09:21	3,43	8	27,45	CHI
202012143404	PORANGATU	PO12027986	PORANGATU	25/12/2020 05:57	25/12/2020 08:40	25/12/2020 05:57	25/12/2020 08:40	2,71	5	13,56	CHI
202012142861	EDEALINA	ED12000006	PONTALINA	25/12/2020 05:58	25/12/2020 08:20	25/12/2020 05:58	25/12/2020 08:20	2,36	4	9,44	CHI
202012142861	PONTALINA	ED12000006	PONTALINA	25/12/2020 05:58	25/12/2020 08:20	25/12/2020 05:58	25/12/2020 08:20	2,36	18	42,48	CHI
202012143159	NOVA ROMA	ND12394116	IACIARA S2	25/12/2020 06:00	25/12/2020 09:07	25/12/2020 06:00	25/12/2020 09:07	3,10	5	15,52	CHI
202012143159	SAO JOAO D ALIANCA	ND12394116	IACIARA S2	25/12/2020 06:00	25/12/2020 09:07	25/12/2020 06:00	25/12/2020 09:07	3,10	15	46,57	CHI
202012142871	INDIARA	EA12257973	EDEIA	25/12/2020 06:01	25/12/2020 14:02	25/12/2020 06:01	25/12/2020 14:02	8,01	7	56,05	CHI
202012142871	EDEIA	EA12257973	EDEIA	25/12/2020 06:01	25/12/2020 14:02	25/12/2020 06:01	25/12/2020 14:02	8,01	33	264,23	CHI
202012142871	ACREUNA	EA12257973	EDEIA	25/12/2020 06:01	25/12/2020 14:02	25/12/2020 06:01	25/12/2020 14:02	8,01	13	104,09	CHI
202012142873	CORUMBAIBA	CI12076939	VILA CORUMBA	25/12/2020 06:01	25/12/2020 09:42	25/12/2020 06:01	25/12/2020 09:42	3,67	7	25,69	CHI
202012142874	PONTALINA	PK32047337	VICENTINOPOLIS	25/12/2020 06:01	25/12/2020 09:50	25/12/2020 06:01	25/12/2020 09:50	3,80	2	7,61	CHI
202012142935	RIO QUENTE	RQ12100108	RIO QUENTE	25/12/2020 06:01	25/12/2020 08:09	25/12/2020 06:01	25/12/2020 08:09	2,12	8	16,97	CHI
202012143396	PALMINOPOLIS	PP12233311RE	PALMEIRAS	25/12/2020 06:01	25/12/2020 09:59	25/12/2020 06:01	25/12/2020 09:59	3,97	39	154,70	CHI
202012143396	JANDAIA	PP12233311RE	PALMEIRAS	25/12/2020 06:01	25/12/2020 09:59	25/12/2020 06:01	25/12/2020 09:59	3,97	18	71,40	CHI
202012143444	JANDAIA	JD21046342	PALMEIRAS	25/12/2020 06:01	25/12/2020 16:50	25/12/2020 06:01	25/12/2020 16:50	10,82	1	10,82	CHI
202012142910	ITAPIRAPUA	IU12121437	MATRINCHA	25/12/2020 06:02	25/12/2020 07:59	25/12/2020 06:02	25/12/2020 07:59	1,94	16	31,00	CHI
202012143298	BALIZA	BH12331338	CAIAPONIA	25/12/2020 06:02	25/12/2020 16:00	25/12/2020 06:02	25/12/2020 16:00	9,95	78	776,36	CHI
202012179452	GOIANIA	GN12000348	FERROVIARIO S2	25/12/2020 06:02	25/12/2020 09:28	25/12/2020 06:02	25/12/2020 09:28	3,42	124	424,42	CHI
202012142917	SAO LUIS DE MONTES BELOS	SL32145768	SAO LUIZ DOS MONTES BELOS	25/12/2020 06:03	25/12/2020 09:37	25/12/2020 06:03	25/12/2020 09:37	3,55	29	103,00	CHI
202012143283	SAO JOAO D ALIANCA	JL12376675LD	ITUIQUIRA	25/12/2020 06:04	25/12/2020 11:41	25/12/2020 06:04	25/12/2020 11:41	5,61	38	213,36	CHI
202012144031	SANTA FE DE GOIAS	RN12391528	BRITANIA	25/12/2020 06:04	25/12/2020 19:53	25/12/2020 06:04	25/12/2020 19:53	13,82	6	82,89	CHI
202012142897	CALDAS NOVAS	CN12332905	CALDAS NOVAS S1	25/12/2020 06:05	25/12/2020 15:25	25/12/2020 06:05	25/12/2020 15:25	9,33	30	279,99	CHI
202012142900	ACREUNA	8576301	ACREUNA	25/12/2020 06:06	26/12/2020 14:53	25/12/2020 06:06	26/12/2020 14:53	32,78	27	885,08	CHI
202012142900	ACREUNA	20890769	ACREUNA	25/12/2020 06:06	26/12/2020 14:53	25/12/2020 06:07	26/12/2020 14:53	32,77	1	32,77	CHI
202012142987	AMARALINA	LC12270203	SAO MIGUEL DO ARAGUAIA	25/12/2020 06:06	25/12/2020 12:09	25/12/2020 06:06	25/12/2020 12:09	6,04	9	54,35	CHI
202012144423	ITARUMA	CC12000108	CACHOEIRA ALTA	25/12/2020 06:06	25/12/2020 14:29	25/12/2020 06:06	25/12/2020 14:29	8,38	15	125,72	CHI
202012142847	ABADIANIA	AA12382107	CORUMBA	25/12/2020 06:07	25/12/2020 16:50	25/12/2020 06:07	25/12/2020 16:50	10,71	27	289,06	CHI
202012142911	PONTALINA	AD12293239	GOIATUBA S1	25/12/2020 06:08	25/12/2020 07:26	25/12/2020 06:08	25/12/2020 07:26	1,29	6	7,73	CHI
202012142911	ALOANDIA	AD12293239	GOIATUBA S1	25/12/2020 06:08	25/12/2020 07:26	25/12/2020 06:08	25/12/2020 07:26	1,29	3	3,87	CHI
202012142914	ANAPOLIS	AN11196847	ANAPOLIS UNIVERSITARIO S2	25/12/2020 06:09	25/12/2020 12:02	25/12/2020 06:09	25/12/2020 12:02	5,88	66	387,86	CHI
202012142919	MAURILANDIA	ML12303541	RIO DOS BOIS	25/12/2020 06:11	25/12/2020 09:30	25/12/2020 06:11	25/12/2020 09:30	3,31	2	6,63	CHI
202012142924	MARA ROSA	MQ12390480	MARA ROSA	25/12/2020 06:11	25/12/2020 08:24	25/12/2020 06:11	25/12/2020 08:24	2,21	4	8,82	CHI
202012142924	CAMPINORTE	MQ12390480	MARA ROSA	25/12/2020 06:11	25/12/2020 08:24	25/12/2020 06:11	25/12/2020 08:24	2,21	1	2,21	CHI
202012142932	MORRINHOS	MR12000105	MORRINHOS	25/12/2020 06:12	25/12/2020 09:43	25/12/2020 06:12	25/12/2020 09:43	3,50	6	21,03	CHI
202012142939	BELA VISTA DE GOIAS	BV12080831	CRISTIANOPOLIS	25/12/2020 06:12	25/12/2020 08:19	25/12/2020 06:12	25/12/2020 08:19	2,11	1	2,11	CHI
202012142939	SAO MIGUEL DO PASSA QUATRO	BV12080831	CRISTIANOPOLIS	25/12/2020 06:12	25/12/2020 08:19	25/12/2020 06:12	25/12/2020 08:19	2,11	14	29,58	CHI
202012144703	ITAPIRAPUA	IU12018852	MATRINCHA	25/12/2020 06:12	25/12/2020 12:38	25/12/2020 06:12	25/12/2020 12:38	6,42	36	231,23	CHI
202012142933	JUSSARA	JR12259810	BRITANIA	25/12/2020 06:13	25/12/2020 10:54	25/12/2020 06:13	25/12/2020 10:54	4,68	49	229,29	CHI
202012142936	PIRACANJUBA	PJ12039733	PIRACANJUBA	25/12/2020 06:13	25/12/2020 09:01	25/12/2020 06:13	25/12/2020 09:01	2,78	28	77,94	CHI
202012142941	GOIAS	GS12058298	MATRINCHA	25/12/2020 06:15	25/12/2020 10:53	25/12/2020 06:15	25/12/2020 10:53	4,63	27	125,09	CHI
202012142944	ITAJA	IJ12062602	ITAJA S2	25/12/2020 06:15	25/12/2020 08:34	25/12/2020 06:15	25/12/2020 08:34	2,31	2	4,62	CHI
202012142946	MORRO AGUDO DE GOIAS	MS12136795	ITAPURANGA	25/12/2020 06:15	25/12/2020 08:10	25/12/2020 06:15	25/12/2020 08:10	1,91	37	70,49	CHI
202012143367	GOIAS	GS13000110	GOIAS	25/12/2020 06:15	25/12/2020 14:27	25/12/2020 11:08	25/12/2020 14:06	2,97	26	77,29	CHI
202012143367	GOIAS	GS12250577	GOIAS	25/12/2020 06:15	25/12/2020 14:27	25/12/2020 06:15	25/12/2020 14:27	8,20	9	73,77	CHI
202012144022	ITUMBIARA	BJ12257011	BOM JESUS DE GOIAS	25/12/2020 06:17	25/12/2020 12:00	25/12/2020 06:17	25/12/2020 12:00	5,71	5	28,55	CHI
202012142961	PIRACANJUBA	PJ12000075	PIRACANJUBA	25/12/2020 06:18	25/12/2020 07:40	25/12/2020 06:18	25/12/2020 07:40	1,36	48	65,49	CHI
202012142963	NOVO BRASIL	NB12292796	JUSSARA	25/12/2020 06:18	25/12/2020 16:25	25/12/2020 06:18	25/12/2020 16:25	10,11	2	20,21	CHI
202012143174	SANTO ANTONIO DA BARRA	BZ12428466	ACREUNA	25/12/2020 06:18	25/12/2020 17:15	25/12/2020 06:18	25/12/2020 17:15	10,94	13	142,19	CHI

202012143238	PONTALINA	PK12047371RE	VICENTINOPOLIS	25/12/2020 06:18	25/12/2020 08:40	25/12/2020 06:18	25/12/2020 08:40	2,35	49	115,35	CHI
202012143303	VILA PROPICIO	PV12069121	GOIANESIA S1	25/12/2020 06:18	25/12/2020 12:05	25/12/2020 06:18	25/12/2020 12:05	5,78	5	28,88	CHI
202012143861	NEROPOLIS	NR11162134	NEROPOLIS S2	25/12/2020 06:19	25/12/2020 20:00	25/12/2020 06:19	25/12/2020 20:00	13,68	163	2229,70	CHI
202012142969	CRISTALINA	KR13213688	CRISTALINA S2	25/12/2020 06:20	25/12/2020 11:27	25/12/2020 06:20	25/12/2020 11:27	5,12	192	983,84	CHI
202012142971	LEOPOLDO DE BULHOES	LB12012179	DAIA S2	25/12/2020 06:20	25/12/2020 11:14	25/12/2020 06:20	25/12/2020 11:14	4,89	11	53,83	CHI
202012142981	ORIZONA	OZ12000353LD	PIRES DO RIO S1	25/12/2020 06:22	25/12/2020 11:38	25/12/2020 06:22	25/12/2020 11:38	5,26	36	189,29	CHI
202012143103	MIMOSO DE GOIAS	MU12165657	PADRE BERNARDO	25/12/2020 06:22	25/12/2020 10:24	25/12/2020 06:22	25/12/2020 10:24	4,02	31	124,65	CHI
202012143222	MARA ROSA	MQ12150566	MARA ROSA	25/12/2020 06:25	25/12/2020 09:15	25/12/2020 06:25	25/12/2020 09:15	2,83	7	19,79	CHI
202012143222	ESTRELA DO NORTE	MQ12150566	MARA ROSA	25/12/2020 06:25	25/12/2020 09:15	25/12/2020 06:25	25/12/2020 09:15	2,83	7	19,79	CHI
202012142893	URUTAI	7690576	URUTAI	25/12/2020 06:26	25/12/2020 10:12	25/12/2020 06:26	25/12/2020 10:12	3,77	9	33,92	CHI
202012143505	BURITI DE GOIAS	CO12054663	FIRMINOPOLIS S2	25/12/2020 06:31	25/12/2020 09:35	25/12/2020 06:31	25/12/2020 09:35	3,06	10	30,63	CHI
202012144508	CORUMBAIBA	MG12000361	VILA CORUMBA	25/12/2020 06:31	25/12/2020 12:36	25/12/2020 06:31	25/12/2020 12:36	6,08	2	12,15	CHI
202012144508	CALDAS NOVAS	MG12000361	VILA CORUMBA	25/12/2020 06:31	25/12/2020 12:36	25/12/2020 06:31	25/12/2020 12:36	6,08	3	18,23	CHI
202012143337	SAO JOAO D ALIANCA	JL12383335	SAO JOAO D ALIANCA	25/12/2020 06:32	25/12/2020 09:28	25/12/2020 06:32	25/12/2020 09:28	2,92	11	32,13	CHI
202012143031	CALDAS NOVAS	CN21100177	VILA CORUMBA	25/12/2020 06:33	25/12/2020 13:00	25/12/2020 06:33	25/12/2020 13:00	6,45	1	6,45	CHI
202012144205	PIRES DO RIO	PR12075715	PIRES DO RIO S1	25/12/2020 06:34	25/12/2020 14:36	25/12/2020 06:34	25/12/2020 14:36	8,02	6	48,14	CHI
202012143040	FORMOSA	FA12207282	ITUIQUIRA	25/12/2020 06:35	25/12/2020 09:00	25/12/2020 06:35	25/12/2020 09:00	2,41	14	33,67	CHI
202012143521	ALEXANIA	AX12374685	CORUMBA	25/12/2020 06:35	25/12/2020 17:11	25/12/2020 06:35	25/12/2020 17:11	10,60	52	550,98	CHI
202012143045	FLORES DE GOIAS	FA12404371	ITUIQUIRA	25/12/2020 06:37	25/12/2020 11:43	25/12/2020 06:37	25/12/2020 11:43	5,09	1	5,09	CHI
202012143045	FORMOSA	FA12404371	ITUIQUIRA	25/12/2020 06:37	25/12/2020 11:43	25/12/2020 06:37	25/12/2020 11:43	5,09	90	457,87	CHI
202012143138	ORIZONA	OZ12073391	PIRES DO RIO S2	25/12/2020 06:37	25/12/2020 08:54	25/12/2020 06:37	25/12/2020 08:54	2,28	9	20,48	CHI
202012143051	JARAGUA	JA12273002	JARAGUA	25/12/2020 06:38	25/12/2020 22:23	25/12/2020 06:38	25/12/2020 22:23	15,74	25	393,42	CHI
202012142554	IPORA	AY12139436	ARENOPOLIS	25/12/2020 06:42	25/12/2020 14:50	25/12/2020 06:42	25/12/2020 14:50	8,13	10	81,29	CHI
202012142554	ARENOPOLIS	AY12139436	ARENOPOLIS	25/12/2020 06:42	25/12/2020 14:50	25/12/2020 06:42	25/12/2020 14:50	8,13	16	130,07	CHI
202012143062	CUMARI	CT12215750RE	CATALAO S1	25/12/2020 06:42	25/12/2020 09:32	25/12/2020 06:42	25/12/2020 09:32	2,83	0	0,00	CHI
202012143062	CATALAO	CT12215750RE	CATALAO S1	25/12/2020 06:42	25/12/2020 09:32	25/12/2020 06:42	25/12/2020 09:32	2,83	20	56,56	CHI
202012143477	ITAGUARU	IC12307618	ITAPURANGA	25/12/2020 06:42	25/12/2020 11:43	25/12/2020 06:42	25/12/2020 11:43	5,00	7	35,01	CHI
202012143715	JANDAIA	JD12373324	PALMEIRAS	25/12/2020 06:44	25/12/2020 10:52	25/12/2020 06:44	25/12/2020 10:52	4,12	149	614,29	CHI
202012143074	NOVA CRIXAS	NA12131934	NOVA CRIXAS	25/12/2020 06:45	25/12/2020 14:48	25/12/2020 06:45	25/12/2020 14:48	8,04	172	1383,12	CHI
202012144892	SANTO ANTONIO DE GOIAS	BW12146000	NEROPOLIS S1	25/12/2020 06:45	25/12/2020 16:03	25/12/2020 06:45	25/12/2020 16:03	9,30	420	3906,23	CHI
202012143119	ANAPOLIS	AN12262497	ANAPOLIS UNIVERSITARIO S1	25/12/2020 06:46	25/12/2020 11:33	25/12/2020 06:46	25/12/2020 11:33	4,77	4	19,09	CHI
202012143686	MINEIROS	MY12303867	PARQUE DAS EMAS	25/12/2020 06:46	25/12/2020 11:52	25/12/2020 06:46	25/12/2020 11:52	5,10	8	40,83	CHI
202012143083	PEROLANDIA	DP12210131RE	PARQUE DAS EMAS	25/12/2020 06:47	25/12/2020 11:28	25/12/2020 06:47	25/12/2020 11:28	4,68	5	23,39	CHI
202012143083	PORTELANDIA	DP12210131RE	PARQUE DAS EMAS	25/12/2020 06:47	25/12/2020 11:28	25/12/2020 06:47	25/12/2020 11:28	4,68	1	4,68	CHI
202012143083	MINEIROS	DP12210131RE	PARQUE DAS EMAS	25/12/2020 06:47	25/12/2020 11:28	25/12/2020 06:47	25/12/2020 11:28	4,68	8	37,43	CHI
202012143250	CEZARINA	ED12223288	PONTALINA	25/12/2020 06:48	25/12/2020 09:13	25/12/2020 06:48	25/12/2020 09:13	2,41	4	9,65	CHI
202012143250	EDEALINA	ED12223288	PONTALINA	25/12/2020 06:48	25/12/2020 09:13	25/12/2020 06:48	25/12/2020 09:13	2,41	80	193,09	CHI
202012143250	INDIARA	ED12223288	PONTALINA	25/12/2020 06:48	25/12/2020 09:13	25/12/2020 06:48	25/12/2020 09:13	2,41	2	4,83	CHI
202012143986	ITAGUARU	IC12219948	ITABERAI S1	25/12/2020 06:49	25/12/2020 11:54	25/12/2020 06:49	25/12/2020 11:54	5,07	11	55,74	CHI
202012143094	CRISTIANOPOLIS	CF12000002LD	CRISTIANOPOLIS	25/12/2020 06:50	26/12/2020 00:36	25/12/2020 06:50	26/12/2020 00:36	17,77	5	88,84	CHI
202012143094	PIRACANJUBA	CF12000002LD	CRISTIANOPOLIS	25/12/2020 06:50	26/12/2020 00:36	25/12/2020 21:20	26/12/2020 00:36	3,26	163	532,01	CHI
202012143094	CRISTIANOPOLIS	CF12000002LD	CRISTIANOPOLIS	25/12/2020 06:50	26/12/2020 00:36	25/12/2020 21:20	26/12/2020 00:36	3,26	99	323,13	CHI
202012143095	CACHOEIRA DOURADA	CD12000044	CACHOEIRA DOURADA	25/12/2020 06:50	25/12/2020 08:59	25/12/2020 06:50	25/12/2020 08:59	2,14	11	23,49	CHI
202012143100	BONOPOLIS	BX12168214	SAO MIGUEL DO ARAGUAIA	25/12/2020 06:51	25/12/2020 17:21	25/12/2020 06:51	25/12/2020 17:21	10,50	121	1270,10	CHI
202012143104	PARAUNA	PU12081329	PARAUNA	25/12/2020 06:52	25/12/2020 10:26	25/12/2020 06:52	25/12/2020 10:26	3,56	71	252,90	CHI
202012143106	APARECIDA DE GOIANIA	AP11079021	INDEPENDENCIA S1	25/12/2020 06:52	25/12/2020 22:02	25/12/2020 06:52	25/12/2020 22:02	15,16	93	1409,57	CHI
202012143107	MUTUNOPOLIS	MU12354547	MARA ROSA	25/12/2020 06:52	25/12/2020 22:23	25/12/2020 06:52	25/12/2020 22:23	15,51	13	201,58	CHI
202012143108	PLANALTINA	PI12085567	PLANALTINA	25/12/2020 06:52	25/12/2020 09:03	25/12/2020 06:52	25/12/2020 09:03	2,17	5	10,86	CHI
202012143109	GOIANIA	GN11082032	REAL S1	25/12/2020 06:52	25/12/2020 08:45	25/12/2020 08:28	25/12/2020 08:45	0,28	160	45,33	CHI
202012143111	GUARANI DE GOIAS	GY12267993	IACIARA S1	25/12/2020 06:53	25/12/2020 08:30	25/12/2020 06:53	25/12/2020 08:30	1,62	51	82,41	CHI
202012143118	FORMOSA	FA12245454LD	ITUIQUIRA	25/12/2020 06:54	25/12/2020 09:54	25/12/2020 06:54	25/12/2020 09:54	2,99	1	2,99	CHI

202012143265	NOVA ROMA	ND12392238	IACIARA S2	25/12/2020 06:54	25/12/2020 09:36	25/12/2020 06:54	25/12/2020 09:36	2,70	237	639,50	CHI
202012143430	CACU	CC12000121RE	CACHOEIRA ALTA	25/12/2020 06:54	25/12/2020 15:13	25/12/2020 06:54	25/12/2020 15:13	8,31	20	166,27	CHI
202012143204	ARAGUAPAZ	AZ12042914	MOZARLANDIA	25/12/2020 06:55	25/12/2020 11:52	25/12/2020 06:55	25/12/2020 11:52	4,94	14	69,12	CHI
202012143305	SAO MIGUEL DO ARAGUAIA	SM12253876	SAO MIGUEL DO ARAGUAIA	25/12/2020 06:55	25/12/2020 16:37	25/12/2020 06:55	25/12/2020 16:37	9,69	3	29,08	CHI
202012143223	BONOPOLIS	BX12165447	SAO MIGUEL DO ARAGUAIA	25/12/2020 06:57	25/12/2020 15:53	25/12/2020 06:57	25/12/2020 15:53	8,93	3	26,80	CHI
202012143702	JATAI	JT12216740RE	JATAI S1	25/12/2020 06:57	25/12/2020 17:57	25/12/2020 06:57	25/12/2020 17:57	11,00	50	549,94	CHI
202012143140	MUTUNOPOLIS	MU12141105	MARA ROSA	25/12/2020 06:58	25/12/2020 11:15	25/12/2020 06:58	25/12/2020 11:15	4,27	24	102,46	CHI
202012144201	NOVA CRIXAS	NA12334349	NOVA CRIXAS	25/12/2020 06:58	25/12/2020 16:58	25/12/2020 06:58	25/12/2020 16:58	10,00	85	849,93	CHI
202012143141	APORE	AE12196218	ITAJA S1	25/12/2020 06:59	25/12/2020 14:49	25/12/2020 06:59	25/12/2020 14:49	7,83	1	7,83	CHI
202012143144	SENADOR CANEDO	SW12078828	CEPAIGO S1	25/12/2020 06:59	25/12/2020 17:27	25/12/2020 06:59	25/12/2020 09:04	2,08	151	314,29	CHI
202012143144	SENADOR CANEDO	19761554	CEPAIGO S1	25/12/2020 06:59	25/12/2020 17:27	25/12/2020 06:59	25/12/2020 17:12	10,23	2	20,45	CHI
202012143144	SENADOR CANEDO	SW21164337	CEPAIGO S1	25/12/2020 06:59	25/12/2020 17:27	25/12/2020 06:59	25/12/2020 17:25	10,43	3	31,29	CHI
202012143144	SENADOR CANEDO	SW21132092	CEPAIGO S1	25/12/2020 06:59	25/12/2020 17:27	25/12/2020 06:59	25/12/2020 17:27	10,46	3	31,38	CHI
202012143146	CATURAI	250016114	ARACU	25/12/2020 06:59	25/12/2020 09:44	25/12/2020 06:59	25/12/2020 09:44	2,75	1	2,75	CHI
202012143151	VALPARAISO DE GOIAS	VA11346465	MARAJOARA	25/12/2020 07:00	25/12/2020 09:35	25/12/2020 07:00	25/12/2020 09:35	2,57	34	87,38	CHI
202012143152	PARAUNA	PU12194225	FIRMINOPOLIS S2	25/12/2020 07:00	25/12/2020 09:03	25/12/2020 07:00	25/12/2020 09:03	2,04	12	24,43	CHI
202012143153	RIO VERDE	RV12135973	CABRIUVA S2	25/12/2020 07:00	25/12/2020 10:41	25/12/2020 07:00	25/12/2020 10:41	3,68	11	40,48	CHI
202012144106	CAIAPONIA	CP12301812	CAIAPONIA	25/12/2020 07:00	26/12/2020 10:54	25/12/2020 07:00	26/12/2020 10:54	27,89	9	250,99	CHI
202012143157	ALTO HORIZONTE	AJ21232305	SANTA TEREZINHA	25/12/2020 07:01	25/12/2020 09:56	25/12/2020 07:01	25/12/2020 09:56	2,90	1	2,90	CHI
202012143161	CAMPOS VERDES	VD12363564	SANTA TEREZINHA	25/12/2020 07:03	25/12/2020 10:58	25/12/2020 07:03	25/12/2020 10:58	3,91	32	125,16	CHI
202012143162	SAO MIGUEL DO ARAGUAIA	SM12182432	SAO MIGUEL DO ARAGUAIA	25/12/2020 07:03	25/12/2020 10:12	25/12/2020 07:03	25/12/2020 10:12	3,14	8	25,10	CHI
202012143164	JUSSARA	IU12087423	MATRINCHA	25/12/2020 07:04	26/12/2020 10:07	25/12/2020 07:04	26/12/2020 10:07	27,05	4	108,19	CHI
202012143165	PALESTINA DE GOIAS	PY18223011TS	PALESTINA	25/12/2020 07:04	25/12/2020 09:57	25/12/2020 07:04	25/12/2020 09:57	2,88	114	328,19	CHI
202012143166	MINACU	IH12242031	MINACU	25/12/2020 07:04	25/12/2020 09:32	25/12/2020 07:04	25/12/2020 09:32	2,46	4	9,84	CHI
202012144354	CORUMBAIBA	CI12333281RE	VILA CORUMBA	25/12/2020 07:05	25/12/2020 16:09	25/12/2020 07:05	25/12/2020 16:09	9,06	115	1042,03	CHI
202012143363	NOVA AURORA	CI12377073	CATALAO S1	25/12/2020 07:06	25/12/2020 10:09	25/12/2020 07:06	25/12/2020 10:09	3,05	8	24,36	CHI
202012143363	CORUMBAIBA	CI12377073	CATALAO S1	25/12/2020 07:06	25/12/2020 10:09	25/12/2020 07:06	25/12/2020 10:09	3,05	6	18,27	CHI
202012143179	IACIARA	IA12164539	IACIARA S2	25/12/2020 07:07	25/12/2020 10:01	25/12/2020 07:07	25/12/2020 10:01	2,90	25	72,42	CHI
202012143182	POSSE	AQ12257608	FLORES DE GOIAS	25/12/2020 07:07	25/12/2020 09:49	25/12/2020 07:07	25/12/2020 09:49	2,69	2	5,39	CHI
202012143182	IACIARA	AQ12257608	FLORES DE GOIAS	25/12/2020 07:07	25/12/2020 09:49	25/12/2020 07:07	25/12/2020 09:49	2,69	4	10,78	CHI
202012143182	ALVORADA DO NORTE	AQ12257608	FLORES DE GOIAS	25/12/2020 07:07	25/12/2020 09:49	25/12/2020 07:07	25/12/2020 09:49	2,69	10	26,94	CHI
202012143185	NOVO GAMA	NU12401782	PACAEMBU S2	25/12/2020 07:08	25/12/2020 08:55	25/12/2020 07:08	25/12/2020 08:55	1,78	2	3,57	CHI
202012143278	PIRANHAS	PH12273643	PIRANHAS	25/12/2020 07:10	25/12/2020 15:27	25/12/2020 07:10	25/12/2020 15:27	8,28	15	124,13	CHI
202012143594	ITAGUARU	IC12068838	ITABERAI S1	25/12/2020 07:10	25/12/2020 09:56	25/12/2020 07:10	25/12/2020 09:56	2,75	11	30,27	CHI
202012143211	GUARAITA	GK12274378	ITAPURANGA	25/12/2020 07:11	25/12/2020 09:16	25/12/2020 07:11	25/12/2020 09:16	2,07	14	28,98	CHI
202012143213	ITAUCU	IX12317351	INHUMAS S1	25/12/2020 07:13	25/12/2020 15:26	25/12/2020 07:13	25/12/2020 15:26	8,21	2	16,41	CHI
202012143497	CORUMBAIBA	CI12021432	VILA CORUMBA	25/12/2020 07:13	25/12/2020 13:28	25/12/2020 07:13	25/12/2020 13:28	6,23	2	12,47	CHI
202012143221	BOM JARDIM DE GOIAS	BM12296970	BOM JARDIM	25/12/2020 07:14	25/12/2020 13:10	25/12/2020 07:14	25/12/2020 13:10	5,93	8	47,45	CHI
202012143227	URUACU	UR12341322	URUACU	25/12/2020 07:15	25/12/2020 09:03	25/12/2020 07:15	25/12/2020 09:03	1,79	6	10,75	CHI
202012143608	MAIRIPOTABA	MI12120719	PONTALINA	25/12/2020 07:15	25/12/2020 09:20	25/12/2020 07:15	25/12/2020 09:20	2,07	1	2,07	CHI
202012143608	CROMINIA	MI12120719	PONTALINA	25/12/2020 07:15	25/12/2020 09:20	25/12/2020 07:15	25/12/2020 09:20	2,07	5	10,34	CHI
202012143871	GOIANESIA	BA12163310	GOIANESIA S1	25/12/2020 07:15	25/12/2020 11:32	25/12/2020 07:15	25/12/2020 11:32	4,28	2	8,55	CHI
202012143871	VILA PROPICIO	BA12163310	GOIANESIA S1	25/12/2020 07:15	25/12/2020 11:32	25/12/2020 07:15	25/12/2020 11:32	4,28	11	47,04	CHI
202012143235	MOZARLANDIA	MZ12057125	MOZARLANDIA	25/12/2020 07:16	25/12/2020 09:35	25/12/2020 07:16	25/12/2020 09:35	2,30	2	4,61	CHI
202012143493	ITAPIRAPUA	IU12016406	MATRINCHA	25/12/2020 07:16	25/12/2020 11:17	25/12/2020 07:16	25/12/2020 11:17	4,01	12	48,08	CHI
202012143291	SITIO D ABADIA	FB12245566	IACIARA S2	25/12/2020 07:17	25/12/2020 12:21	25/12/2020 07:17	25/12/2020 12:21	5,05	39	197,08	CHI
202012143291	FLORES DE GOIAS	FB12245566	IACIARA S2	25/12/2020 07:17	25/12/2020 12:21	25/12/2020 07:17	25/12/2020 12:21	5,05	73	368,89	CHI
202012143838	BRITANIA	IU12025065	MATRINCHA	25/12/2020 07:18	25/12/2020 10:50	25/12/2020 07:18	25/12/2020 10:50	3,55	6	21,28	CHI
202012143838	ITAPIRAPUA	IU12025065	MATRINCHA	25/12/2020 07:18	25/12/2020 10:50	25/12/2020 07:18	25/12/2020 10:50	3,55	15	53,21	CHI
202012143244	ABADIANIA	00020214	ANAPOLIS UNIVERSITARIO S1	25/12/2020 07:19	25/12/2020 11:33	25/12/2020 07:19	25/12/2020 11:33	4,23	70	296,02	CHI
202012143244	ANAPOLIS	00020214	ANAPOLIS UNIVERSITARIO S1	25/12/2020 07:19	25/12/2020 11:33	25/12/2020 07:19	25/12/2020 11:33	4,23	418	1767,68	CHI

202012143310	NAZARIO	AC12034105	ANICUNS	25/12/2020 07:19	25/12/2020 09:44	25/12/2020 07:19	25/12/2020 09:44	2,41	9	21,69	CHI
202012143310	ANICUNS	AC12034105	ANICUNS	25/12/2020 07:19	25/12/2020 09:44	25/12/2020 07:19	25/12/2020 09:44	2,41	1	2,41	CHI
202012143248	CACU	CC12019876	CACHOEIRA ALTA	25/12/2020 07:20	25/12/2020 15:05	25/12/2020 07:20	25/12/2020 15:05	7,75	1	7,75	CHI
202012143251	COCALZINHO DE GOIAS	ZN12330813	PADRE BERNARDO	25/12/2020 07:21	25/12/2020 11:55	25/12/2020 07:21	25/12/2020 11:55	4,56	3	13,69	CHI
202012143253	CORUMBA DE GOIAS	CB12317749	CORUMBA	25/12/2020 07:21	25/12/2020 14:18	25/12/2020 07:21	25/12/2020 14:18	6,94	5	34,70	CHI
202012143253	ABADIANIA	CB12317749	CORUMBA	25/12/2020 07:21	25/12/2020 14:18	25/12/2020 07:21	25/12/2020 14:18	6,94	3	20,82	CHI
202012143781	FORMOSA	FA12195886LD	ITUIQUIRA	25/12/2020 07:21	25/12/2020 12:48	25/12/2020 07:21	25/12/2020 12:48	5,44	48	261,25	CHI
202012143704	CORUMBA DE GOIAS	CB12381243	CORUMBA	25/12/2020 07:22	25/12/2020 17:32	25/12/2020 07:22	25/12/2020 11:36	4,24	7	29,65	CHI
202012143704	CORUMBA DE GOIAS	CB12381243	CORUMBA	25/12/2020 07:22	25/12/2020 17:32	25/12/2020 11:51	25/12/2020 17:32	5,68	7	39,75	CHI
202012143262	PARAUNA	PU12279674	ACREUNA	25/12/2020 07:23	25/12/2020 11:12	25/12/2020 07:23	25/12/2020 11:12	3,81	4	15,24	CHI
202012143282	PLANALTINA	PI12375539	PLANALTINA	25/12/2020 07:26	25/12/2020 12:05	25/12/2020 07:26	25/12/2020 12:05	4,66	42	195,64	CHI
202012143293	NOVA CRIXAS	NA12281131	MOZARLANDIA	25/12/2020 07:28	25/12/2020 12:48	25/12/2020 07:28	25/12/2020 12:48	5,33	1	5,33	CHI
202012143296	SILVANIA	SV12080211	VIANOPOLIS	25/12/2020 07:28	25/12/2020 09:20	25/12/2020 07:28	25/12/2020 09:20	1,85	4	7,41	CHI
202012179443	BELA VISTA DE GOIAS	HD10400804	CEPAIGO S2	25/12/2020 07:28	25/12/2020 18:46	25/12/2020 07:34	25/12/2020 07:43	0,16	8	1,29	CHI
202012179443	HIDROLANDIA	HD10400804	CEPAIGO S2	25/12/2020 07:28	25/12/2020 18:46	25/12/2020 07:34	25/12/2020 07:43	0,16	169	27,27	CHI
202012179443	HIDROLANDIA	HD16424179	CEPAIGO S2	25/12/2020 07:28	25/12/2020 18:46	25/12/2020 07:28	25/12/2020 11:39	4,19	20	83,70	CHI
202012179443	HIDROLANDIA	HD16424179	CEPAIGO S2	25/12/2020 07:28	25/12/2020 18:46	25/12/2020 07:28	25/12/2020 18:46	11,30	72	813,74	CHI
202012179443	BELA VISTA DE GOIAS	HD16424179	CEPAIGO S2	25/12/2020 07:28	25/12/2020 18:46	25/12/2020 07:28	25/12/2020 18:46	11,30	1	11,30	CHI
202012143423	BOM JARDIM DE GOIAS	BH12193416	BOM JARDIM	25/12/2020 07:29	25/12/2020 13:18	25/12/2020 07:29	25/12/2020 13:18	5,81	5	29,07	CHI
202012143423	BALIZA	BH12193416	BOM JARDIM	25/12/2020 07:29	25/12/2020 13:18	25/12/2020 07:29	25/12/2020 13:18	5,81	3	17,44	CHI
202012143326	IPAMERI	IP12079464	CAMPO ALEGRE DE GOIAS	25/12/2020 07:31	25/12/2020 10:05	25/12/2020 07:31	25/12/2020 10:05	2,56	4	10,23	CHI
202012143318	FORMOSA	FA11164549	ITUIQUIRA	25/12/2020 07:33	25/12/2020 09:52	25/12/2020 07:33	25/12/2020 09:52	2,31	307	709,34	CHI
202012143330	ALTO PARAISO DE GOIAS	BF12180774	FLORES DE GOIAS	25/12/2020 07:34	25/12/2020 08:44	25/12/2020 07:34	25/12/2020 08:44	1,15	13	14,96	CHI
202012145660	SANTA FE DE GOIAS	RN12250624	BRITANIA	25/12/2020 07:34	25/12/2020 21:29	25/12/2020 07:34	25/12/2020 21:29	13,91	3	41,74	CHI
202012139091	MINEIROS	MY12402481RE	PARQUE DAS EMAS	25/12/2020 07:37	26/12/2020 14:05	25/12/2020 07:37	26/12/2020 13:09	29,54	2	59,08	CHI
202012139091	PEROLANDIA	MY12402481RE	PARQUE DAS EMAS	25/12/2020 07:37	26/12/2020 14:05	25/12/2020 07:37	26/12/2020 13:09	29,54	4	118,15	CHI
202012139091	PEROLANDIA	MY12402481RE	PARQUE DAS EMAS	25/12/2020 07:37	26/12/2020 14:05	25/12/2020 10:10	26/12/2020 13:09	27,00	2	53,99	CHI
202012139091	MINEIROS	MY12402481RE	PARQUE DAS EMAS	25/12/2020 07:37	26/12/2020 14:05	25/12/2020 10:10	26/12/2020 13:09	27,00	3	80,99	CHI
202012139091	MINEIROS	MY12402481RE	PARQUE DAS EMAS	25/12/2020 07:37	26/12/2020 14:05	25/12/2020 07:37	26/12/2020 14:05	30,47	6	182,83	CHI
202012139091	PEROLANDIA	MY12402481RE	PARQUE DAS EMAS	25/12/2020 07:37	26/12/2020 14:05	25/12/2020 07:37	26/12/2020 14:05	30,47	3	91,42	CHI
202012139091	CAIAPONIA	MY12402481RE	PARQUE DAS EMAS	25/12/2020 07:37	26/12/2020 14:05	25/12/2020 07:37	26/12/2020 14:05	30,47	5	152,36	CHI
202012143341	BRITANIA	BT12250825	BRITANIA	25/12/2020 07:37	25/12/2020 12:32	25/12/2020 07:37	25/12/2020 12:32	4,91	4	19,65	CHI
202012143342	JATAI	RV12040452	CABRIUVA S1	25/12/2020 07:37	25/12/2020 13:17	25/12/2020 07:37	25/12/2020 13:17	5,66	2	11,32	CHI
202012143342	RIO VERDE	RV12040452	CABRIUVA S1	25/12/2020 07:37	25/12/2020 13:17	25/12/2020 07:37	25/12/2020 13:17	5,66	6	33,96	CHI
202012143426	CORUMBA DE GOIAS	CB12215044	CORUMBA	25/12/2020 07:39	25/12/2020 13:54	25/12/2020 07:39	25/12/2020 13:54	6,24	23	143,53	CHI
202012143426	PIRENOPOLIS	CB12215044	CORUMBA	25/12/2020 07:39	25/12/2020 13:54	25/12/2020 07:39	25/12/2020 13:54	6,24	2	12,48	CHI
202012143359	ANAPOLIS	AN12262499	ANAPOLIS UNIVERSITARIO S1	25/12/2020 07:40	25/12/2020 12:47	25/12/2020 07:40	25/12/2020 12:47	5,11	11	56,24	CHI
202012143998	IPAMERI	IP12112268	PIRES DO RIO S2	25/12/2020 07:40	25/12/2020 11:56	25/12/2020 07:40	25/12/2020 11:56	4,25	20	85,06	CHI
202012143365	FORMOSA	FA12375559	PLANALTINA	25/12/2020 07:41	25/12/2020 10:43	25/12/2020 07:41	25/12/2020 10:43	3,03	10	30,27	CHI
202012143377	RIO VERDE	RV12099687	CABRIUVA S2	25/12/2020 07:43	25/12/2020 13:15	25/12/2020 07:43	25/12/2020 13:15	5,52	3	16,57	CHI
202012143385	TRINDADE	TR12015750	INHUMAS S1	25/12/2020 07:44	25/12/2020 17:00	25/12/2020 13:24	25/12/2020 14:10	0,76	11	8,36	CHI
202012143385	GOIANIRA	GR12282901	INHUMAS S1	25/12/2020 07:44	25/12/2020 17:00	25/12/2020 07:44	25/12/2020 16:04	8,33	1	8,33	CHI
202012143385	TRINDADE	GR12282901	INHUMAS S1	25/12/2020 07:44	25/12/2020 17:00	25/12/2020 07:44	25/12/2020 16:04	8,33	19	158,34	CHI
202012143385	TRINDADE	GR12282901	INHUMAS S1	25/12/2020 07:44	25/12/2020 17:00	25/12/2020 12:04	25/12/2020 16:04	4,01	14	56,09	CHI
202012143385	GOIANIRA	GR12282901	INHUMAS S1	25/12/2020 07:44	25/12/2020 17:00	25/12/2020 15:08	25/12/2020 16:04	0,94	21	19,75	CHI
202012143385	TRINDADE	GR12282901	INHUMAS S1	25/12/2020 07:44	25/12/2020 17:00	25/12/2020 15:08	25/12/2020 16:04	0,94	17	15,98	CHI
202012143385	TRINDADE	TR12015761	INHUMAS S1	25/12/2020 07:44	25/12/2020 17:00	25/12/2020 12:04	25/12/2020 16:59	4,92	11	54,16	CHI
202012143385	TRINDADE	7592817	INHUMAS S1	25/12/2020 07:44	25/12/2020 17:00	25/12/2020 12:04	25/12/2020 17:00	4,92	1	4,92	CHI
202012143401	GOIAS	GS12064979	ITAPURANGA	25/12/2020 07:47	25/12/2020 12:12	25/12/2020 07:47	25/12/2020 12:12	4,40	1	4,40	CHI
202012143401	FAINA	GS12064979	ITAPURANGA	25/12/2020 07:47	25/12/2020 12:12	25/12/2020 07:47	25/12/2020 12:12	4,40	3	13,21	CHI
202012143989	AMARALINA	LC12270741	SAO MIGUEL DO ARAGUAIA	25/12/2020 07:47	26/12/2020 15:56	25/12/2020 07:47	26/12/2020 15:56	32,16	10	321,56	CHI



202012143403	CEZARINA	PL12349283	PALMEIRAS	25/12/2020 07:48	25/12/2020 10:25	25/12/2020 07:48	25/12/2020 10:25	2,61	1	2,61	CHI
202012143406	MINEIROS	MY12302014LD	PARQUE DAS EMAS	25/12/2020 07:48	25/12/2020 12:47	25/12/2020 07:48	25/12/2020 12:47	4,99	9	44,87	CHI
202012143406	PORTELANDIA	MY12302014LD	PARQUE DAS EMAS	25/12/2020 07:48	25/12/2020 12:47	25/12/2020 07:48	25/12/2020 12:47	4,99	1	4,99	CHI
202012143412	MORRINHOS	MR12064830	GOIATUBA S1	25/12/2020 07:49	25/12/2020 08:41	25/12/2020 07:49	25/12/2020 08:41	0,87	5	4,33	CHI
202012143418	PALMINOPOLIS	PP12005727	FIRMINOPOLIS S2	25/12/2020 07:49	25/12/2020 09:29	25/12/2020 07:49	25/12/2020 09:29	1,66	41	67,87	CHI
202012143418	PALMEIRAS DE GOIAS	PP12005727	FIRMINOPOLIS S2	25/12/2020 07:49	25/12/2020 09:29	25/12/2020 07:49	25/12/2020 09:29	1,66	13	21,52	CHI
202012143432	DIORAMA	IR10403921	ARENOPOLIS	25/12/2020 07:49	25/12/2020 14:30	25/12/2020 07:49	25/12/2020 11:03	3,23	1	3,23	CHI
202012143432	IPORA	IR10403921	ARENOPOLIS	25/12/2020 07:49	25/12/2020 14:30	25/12/2020 07:49	25/12/2020 11:03	3,23	5	16,16	CHI
202012143432	DIORAMA	IR10403921	ARENOPOLIS	25/12/2020 07:49	25/12/2020 14:30	25/12/2020 07:49	25/12/2020 14:04	6,26	32	200,28	CHI
202012143432	MONTES CLAROS DE GOIAS	IR10403921	ARENOPOLIS	25/12/2020 07:49	25/12/2020 14:30	25/12/2020 07:49	25/12/2020 14:04	6,26	10	62,59	CHI
202012143432	IPORA	IR10403921	ARENOPOLIS	25/12/2020 07:49	25/12/2020 14:30	25/12/2020 07:49	25/12/2020 14:04	6,26	5	31,29	CHI
202012143432	DIORAMA	IR10403921	ARENOPOLIS	25/12/2020 07:49	25/12/2020 14:30	25/12/2020 07:49	25/12/2020 14:30	6,68	76	507,76	CHI
202012143432	MONTES CLAROS DE GOIAS	IR10403921	ARENOPOLIS	25/12/2020 07:49	25/12/2020 14:30	25/12/2020 07:49	25/12/2020 14:30	6,68	32	213,80	CHI
202012143625	PALMELO	PR12000096RE	PIRES DO RIO S1	25/12/2020 07:49	25/12/2020 10:24	25/12/2020 07:49	25/12/2020 10:24	2,58	6	15,47	CHI
202012143625	PIRES DO RIO	PR12000096RE	PIRES DO RIO S1	25/12/2020 07:49	25/12/2020 10:24	25/12/2020 07:49	25/12/2020 10:24	2,58	22	56,72	CHI
202012144515	CEZARINA	CZ21349317	CEZARINA	25/12/2020 07:49	25/12/2020 12:45	25/12/2020 07:49	25/12/2020 12:45	4,92	3	14,77	CHI
202012143603	LEOPOLDO DE BULHOES	BO12400465	CEPAIGO S2	25/12/2020 07:51	25/12/2020 09:30	25/12/2020 07:51	25/12/2020 09:30	1,64	12	19,66	CHI
202012143603	BONFINOPOLIS	BO12400465	CEPAIGO S2	25/12/2020 07:51	25/12/2020 09:30	25/12/2020 07:51	25/12/2020 09:30	1,64	3	4,92	CHI
202012143443	RUBIATABA	RB12392304	RUBIATABA	25/12/2020 07:53	25/12/2020 12:44	25/12/2020 07:53	25/12/2020 12:44	4,85	6	29,07	CHI
202012143447	ITARUMA	IM12033232	CACHOEIRA ALTA	25/12/2020 07:53	25/12/2020 11:31	25/12/2020 07:53	25/12/2020 11:31	3,62	2	7,24	CHI
202012143452	JUSSARA	JR12222898	BRITANIA	25/12/2020 07:55	25/12/2020 10:03	25/12/2020 07:55	25/12/2020 10:03	2,12	2	4,24	CHI
202012144481	NEROPOLIS	NR12356423	NEROPOLIS S2	25/12/2020 07:56	25/12/2020 14:26	25/12/2020 07:56	25/12/2020 14:26	6,49	8	51,91	CHI
202012143457	FIRMINOPOLIS	FR12031438	FIRMINOPOLIS S1	25/12/2020 07:57	25/12/2020 09:34	25/12/2020 07:57	25/12/2020 09:34	1,61	3	4,83	CHI
202012143556	CACU	CC12063074RE	CACHOEIRA ALTA	25/12/2020 07:57	25/12/2020 14:49	25/12/2020 07:57	25/12/2020 14:49	6,85	3	20,55	CHI
202012143556	JATAI	CC12063074RE	CACHOEIRA ALTA	25/12/2020 07:57	25/12/2020 14:49	25/12/2020 07:57	25/12/2020 14:49	6,85	20	137,02	CHI
202012143556	ITARUMA	CC12063074RE	CACHOEIRA ALTA	25/12/2020 07:57	25/12/2020 14:49	25/12/2020 07:57	25/12/2020 14:49	6,85	14	95,91	CHI
202012144599	SERRANOPOLIS	SX12260467	JATAI S1	25/12/2020 07:58	25/12/2020 14:20	25/12/2020 07:58	25/12/2020 14:20	6,36	8	50,87	CHI
202012144630	BONOPOLIS	BX12389669	SAO MIGUEL DO ARAGUAIA	25/12/2020 07:58	26/12/2020 16:19	25/12/2020 07:58	26/12/2020 16:19	32,35	15	485,28	CHI
202012143613	SERRANOPOLIS	SX12390576	JATAI S1	25/12/2020 07:59	25/12/2020 16:15	25/12/2020 07:59	25/12/2020 16:15	8,25	10	82,55	CHI
202012143499	PORANGATU	PO12115502	PORANGATU	25/12/2020 08:03	25/12/2020 11:21	25/12/2020 08:03	25/12/2020 11:21	3,29	94	309,55	CHI
202012143504	EDEIA	EA12160409	VICENTINOPOLIS	25/12/2020 08:03	25/12/2020 10:42	25/12/2020 08:03	25/12/2020 10:42	2,64	21	55,41	CHI
202012143520	GOIATUBA	GT12009417	BOM JESUS DE GOIAS	25/12/2020 08:05	25/12/2020 14:55	25/12/2020 08:05	25/12/2020 14:55	6,82	1	6,82	CHI
202012143529	RIO VERDE	RV21027703	RIO VERDE S1	25/12/2020 08:06	25/12/2020 08:11	25/12/2020 08:06	25/12/2020 08:11	0,07	1	0,07	CHI
202012144583	NOVO BRASIL	NB12019396	JUSSARA	25/12/2020 08:06	25/12/2020 22:09	25/12/2020 08:06	25/12/2020 22:09	14,05	41	575,98	CHI
202012143539	CATALAO	CT12166743RE	CATALAO S1	25/12/2020 08:08	25/12/2020 11:10	25/12/2020 08:08	25/12/2020 11:10	3,02	35	105,85	CHI
202012143540	MARA ROSA	MQ12255170	MARA ROSA	25/12/2020 08:08	25/12/2020 19:01	25/12/2020 08:08	25/12/2020 19:01	10,87	2	21,74	CHI
202012143545	INHUMAS	IN12015984	INHUMAS S2	25/12/2020 08:09	25/12/2020 10:51	25/12/2020 08:09	25/12/2020 10:51	2,70	1	2,70	CHI
202012143545	BRAZABRANTES	IN12015984	INHUMAS S2	25/12/2020 08:09	25/12/2020 10:51	25/12/2020 08:09	25/12/2020 10:51	2,70	2	5,40	CHI
202012143592	FIRMINOPOLIS	AI12032158	FIRMINOPOLIS S2	25/12/2020 08:09	25/12/2020 10:37	25/12/2020 08:09	25/12/2020 10:37	2,45	13	31,88	CHI
202012143592	AURILANDIA	AI12032158	FIRMINOPOLIS S2	25/12/2020 08:09	25/12/2020 10:37	25/12/2020 08:09	25/12/2020 10:37	2,45	6	14,72	CHI
202012144100	ITUMBIARA	IT12352729	ITUMBIARA VELHA S1	25/12/2020 08:11	25/12/2020 11:05	25/12/2020 08:11	25/12/2020 11:05	2,89	41	118,42	CHI
202012143572	RIO VERDE	RV21027703	RIO VERDE S1	25/12/2020 08:12	25/12/2020 12:30	25/12/2020 08:12	25/12/2020 11:50	3,63	1	3,63	CHI
202012143572	RIO VERDE	RV12027702	RIO VERDE S1	25/12/2020 08:12	25/12/2020 12:30	25/12/2020 09:18	25/12/2020 12:30	3,21	1	3,21	CHI
202012143645	PIRANHAS	PH12316430	PIRANHAS	25/12/2020 08:13	25/12/2020 12:47	25/12/2020 08:13	25/12/2020 12:47	4,57	5	22,83	CHI
202012143637	TRINDADE	GR32045904	TRINDADE	25/12/2020 08:14	25/12/2020 10:51	25/12/2020 08:14	25/12/2020 10:51	2,61	4	10,44	CHI
202012143637	GOIANIRA	GR32045904	TRINDADE	25/12/2020 08:14	25/12/2020 10:51	25/12/2020 08:14	25/12/2020 10:51	2,61	4	10,44	CHI
202012143587	NOVO BRASIL	1460003679	JUSSARA	25/12/2020 08:15	25/12/2020 09:40	25/12/2020 08:15	25/12/2020 09:40	1,42	1	1,42	CHI
202012143679	CAIAPONIA	CP12075032	CAIAPONIA	25/12/2020 08:15	25/12/2020 13:13	25/12/2020 08:15	25/12/2020 13:13	4,95	10	49,55	CHI
202012143597	GOIATUBA	GT12044907	GOIATUBA S2	25/12/2020 08:17	25/12/2020 11:30	25/12/2020 08:17	25/12/2020 11:30	3,22	14	45,03	CHI
202012143670	ANAPOLIS	AN12285273	ANAPOLIS UNIVERSITARIO S2	25/12/2020 08:17	25/12/2020 10:25	25/12/2020 08:17	25/12/2020 10:25	2,12	59	124,93	CHI
202012143743	URUACU	UR12181375	URUACU	25/12/2020 08:19	25/12/2020 15:52	25/12/2020 08:19	25/12/2020 15:52	7,55	2	15,09	CHI

202012143878	PORANGATU	PO12321960	PORANGATU	25/12/2020 08:20	25/12/2020 10:09	25/12/2020 08:20	25/12/2020 10:09	1,81	2	3,63	CHI
202012144143	FAZENDA NOVA	FN12295319	IPORA	25/12/2020 08:20	25/12/2020 13:48	25/12/2020 08:20	25/12/2020 13:48	5,46	3	16,39	CHI
202012144251	GOIANIA	GN12034282	ATLANTICO S2	25/12/2020 08:20	25/12/2020 10:23	25/12/2020 08:20	25/12/2020 10:23	2,04	289	589,72	CHI
202012143622	MORRINHOS	MR21049697	MORRINHOS	25/12/2020 08:21	25/12/2020 12:30	25/12/2020 08:21	25/12/2020 12:30	4,14	2	8,28	CHI
202012143624	GOIANIA	GN11362803	ATLANTICO S2	25/12/2020 08:21	25/12/2020 10:15	25/12/2020 09:54	25/12/2020 10:15	0,35	139	48,65	CHI
202012143627	CRISTALINA	KR12074918	CRISTALINA S2	25/12/2020 08:22	25/12/2020 11:23	25/12/2020 08:22	25/12/2020 11:23	3,00	8	24,02	CHI
202012143634	PARANAIGUARA	PC12271707	QUIRINOPOLIS	25/12/2020 08:23	25/12/2020 13:45	25/12/2020 08:23	25/12/2020 13:45	5,36	5	26,80	CHI
202012143648	TURVELANDIA	TD12213488	RIO DOS BOIS	25/12/2020 08:26	25/12/2020 11:13	25/12/2020 08:26	25/12/2020 11:13	2,78	6	16,66	CHI
202012143648	SANTA HELENA DE GOIAS	TD12213488	RIO DOS BOIS	25/12/2020 08:26	25/12/2020 11:13	25/12/2020 08:26	25/12/2020 11:13	2,78	3	8,33	CHI
202012143957	GOIATUBA	GT12263929	GOIATUBA S1	25/12/2020 08:26	25/12/2020 11:14	25/12/2020 08:26	25/12/2020 11:14	2,79	7	19,50	CHI
202012143957	BURITI ALEGRE	GT12263929	GOIATUBA S1	25/12/2020 08:26	25/12/2020 11:14	25/12/2020 08:26	25/12/2020 11:14	2,79	2	5,57	CHI
202012143654	GOIANDIRA	GD121399710	CATALAO S1	25/12/2020 08:28	25/12/2020 10:21	25/12/2020 08:28	25/12/2020 10:21	1,88	23	43,32	CHI
202012143656	CHAPADAO DO CEU	DJ12219562	CHAPADAO DO CEU	25/12/2020 08:28	25/12/2020 17:00	25/12/2020 08:28	25/12/2020 17:00	8,53	9	76,75	CHI
202012143656	MINEIROS	DJ12219562	CHAPADAO DO CEU	25/12/2020 08:28	25/12/2020 17:00	25/12/2020 08:28	25/12/2020 17:00	8,53	2	17,06	CHI
202012143667	IPAMERI	OZ12137542RE	PIRES DO RIO S2	25/12/2020 08:30	25/12/2020 13:23	25/12/2020 08:30	25/12/2020 13:23	4,88	9	43,95	CHI
202012144139	RIO VERDE	RV12327049	CABRIUVA S2	25/12/2020 08:31	25/12/2020 14:53	25/12/2020 08:31	25/12/2020 14:53	6,36	2	12,72	CHI
202012143689	PEROLANDIA	DP12358894	JATAI S1	25/12/2020 08:32	25/12/2020 12:46	25/12/2020 08:32	25/12/2020 12:46	4,22	1	4,22	CHI
202012143698	VICENTINOPOLIS	GT12050354	GOIATUBA S1	25/12/2020 08:33	25/12/2020 12:49	25/12/2020 08:33	25/12/2020 12:49	4,25	1	4,25	CHI
202012143700	CORUMBAIBA	CI12107484	VILA CORUMBA	25/12/2020 08:34	25/12/2020 13:46	25/12/2020 08:34	25/12/2020 13:46	5,20	3	15,59	CHI
202012143706	RIO QUENTE	RQ12100108	RIO QUENTE	25/12/2020 08:35	25/12/2020 13:17	25/12/2020 08:35	25/12/2020 13:17	4,70	8	37,58	CHI
202012143856	CRIXAS	O2910414	SERRA DO OURO	25/12/2020 08:35	25/12/2020 13:03	25/12/2020 09:02	25/12/2020 11:17	2,24	12	26,92	CHI
202012143856	PORANGATU	O2910414	SERRA DO OURO	25/12/2020 08:35	25/12/2020 13:03	25/12/2020 09:02	25/12/2020 12:43	3,68	1	3,68	CHI
202012143856	CRIXAS	O2910414	SERRA DO OURO	25/12/2020 08:35	25/12/2020 13:03	25/12/2020 09:02	25/12/2020 12:43	3,68	4857	17888,60	CHI
202012143856	NOVA ROMA	O2910414	SERRA DO OURO	25/12/2020 08:35	25/12/2020 13:03	25/12/2020 09:02	25/12/2020 12:43	3,68	1	3,68	CHI
202012143856	NOVA CRIXAS	O2910414	SERRA DO OURO	25/12/2020 08:35	25/12/2020 13:03	25/12/2020 09:02	25/12/2020 12:43	3,68	6	22,10	CHI
202012143856	CRIXAS	O0450414	SERRA DO OURO	25/12/2020 08:35	25/12/2020 13:03	25/12/2020 12:45	25/12/2020 12:48	0,05	1	0,05	CHI
202012143856	CRIXAS	O2910414	SERRA DO OURO	25/12/2020 08:35	25/12/2020 13:03	25/12/2020 09:02	25/12/2020 12:49	3,78	1288	4867,57	CHI
202012143856	CRIXAS	O0450414	SERRA DO OURO	25/12/2020 08:35	25/12/2020 13:03	25/12/2020 12:45	25/12/2020 12:58	0,22	1414	306,37	CHI
202012143856	NOVA ROMA	O0450414	SERRA DO OURO	25/12/2020 08:35	25/12/2020 13:03	25/12/2020 12:45	25/12/2020 13:03	0,31	1	0,31	CHI
202012143856	PORANGATU	O0450414	SERRA DO OURO	25/12/2020 08:35	25/12/2020 13:03	25/12/2020 12:45	25/12/2020 13:03	0,31	1	0,31	CHI
202012143856	NOVA CRIXAS	O0450414	SERRA DO OURO	25/12/2020 08:35	25/12/2020 13:03	25/12/2020 12:45	25/12/2020 13:03	0,31	6	1,84	CHI
202012143856	CRIXAS	O0450414	SERRA DO OURO	25/12/2020 08:35	25/12/2020 13:03	25/12/2020 12:45	25/12/2020 13:03	0,31	3445	1058,38	CHI
202012143856	CRIXAS	CX10403945	SERRA DO OURO	25/12/2020 08:35	25/12/2020 13:03	25/12/2020 12:48	25/12/2020 13:03	0,25	1	0,25	CHI
202012143710	PARAUNA	PU12382574	PARAUNA	25/12/2020 08:36	25/12/2020 11:25	25/12/2020 08:36	25/12/2020 11:25	2,81	19	53,45	CHI
202012143713	BRITANIA	BT21101967	BRITANIA	25/12/2020 08:36	26/12/2020 02:34	25/12/2020 08:36	26/12/2020 02:34	17,97	1	17,97	CHI
202012143716	BURITI ALEGRE	BG12006328	ITUMBIAIRA VELHA S2	25/12/2020 08:37	25/12/2020 12:00	25/12/2020 08:37	25/12/2020 12:00	3,37	1	3,37	CHI
202012143718	INHUMAS	IN11012261	INHUMAS S2	25/12/2020 08:37	25/12/2020 14:37	25/12/2020 08:37	25/12/2020 14:37	5,99	63	377,33	CHI
202012143734	SAO DOMINGOS	GH12151237	SAO DOMINGOS	25/12/2020 08:40	25/12/2020 10:40	25/12/2020 08:40	25/12/2020 10:40	1,99	21	41,80	CHI
202012143734	DIVINOPOLIS DE GOIAS	GH12151237	SAO DOMINGOS	25/12/2020 08:40	25/12/2020 10:40	25/12/2020 08:40	25/12/2020 10:40	1,99	29	57,73	CHI
202012144204	ITABERA	IB12075677	ARACU	25/12/2020 08:40	25/12/2020 11:11	25/12/2020 08:40	25/12/2020 11:11	2,50	18	45,08	CHI
202012143741	SANTO ANTONIO DO DESCOBERTO	SN12261262	ALEXANIA	25/12/2020 08:41	25/12/2020 10:28	25/12/2020 08:41	25/12/2020 10:28	1,78	15	26,70	CHI
202012142206	SILVANIA	SV12270699	DAIA S2	25/12/2020 08:44	25/12/2020 12:48	25/12/2020 08:44	25/12/2020 12:48	4,05	5	20,27	CHI
202012143765	ACREUNA	EU12301678	ACREUNA	25/12/2020 08:45	25/12/2020 12:10	25/12/2020 08:45	25/12/2020 12:10	3,42	5	17,10	CHI
202012143766	PLANALTINA	PI12325395	SAO JOAO D ALIANCA	25/12/2020 08:45	25/12/2020 10:54	25/12/2020 08:45	25/12/2020 10:54	2,15	3	6,45	CHI
202012143770	CHAPADAO DO CEU	DJ12160247	CHAPADAO DO CEU	25/12/2020 08:45	25/12/2020 15:29	25/12/2020 08:45	25/12/2020 15:29	6,73	3	20,18	CHI
202012143772	SANCLERLANDIA	SC12299048	FIRMINOPOLIS S2	25/12/2020 08:45	25/12/2020 11:32	25/12/2020 08:45	25/12/2020 11:32	2,77	4	11,09	CHI
202012144188	ARAGARCAS	AG12354688	ARAGARCAS	25/12/2020 08:45	25/12/2020 14:29	25/12/2020 08:45	25/12/2020 14:29	5,73	1	5,73	CHI
202012145199	ARAGARCAS	AG12334918	ARAGARCAS	25/12/2020 08:45	25/12/2020 15:31	25/12/2020 08:45	25/12/2020 15:31	6,77	3	20,30	CHI
202012144333	SAO MIGUEL DO ARAGUAIA	SM12384276	SAO MIGUEL DO ARAGUAIA	25/12/2020 08:47	25/12/2020 12:45	25/12/2020 08:47	25/12/2020 12:45	3,97	4	15,87	CHI
202012143797	CORUMBAIBA	CI12081002	VILA CORUMBA	25/12/2020 08:48	25/12/2020 11:46	25/12/2020 08:48	25/12/2020 11:46	2,95	5	14,75	CHI
202012144242	QUIRINOPOLIS	QI12198335	QUIRINOPOLIS	25/12/2020 08:48	25/12/2020 17:52	25/12/2020 08:48	25/12/2020 17:52	9,07	3	27,22	CHI

202012143801	LUZIANIA	LZ12206730	MARAJOARA	25/12/2020 08:50	25/12/2020 12:12	25/12/2020 08:50	25/12/2020 12:12	3,37	12	40,48	CHI
202012143811	QUIRINOPOLIS	QI32255692	QUIRINOPOLIS	25/12/2020 08:50	25/12/2020 10:00	25/12/2020 08:50	25/12/2020 10:00	1,16	18	20,82	CHI
202012143940	CORUMBAIBA	CI12377064	CATALAO S1	25/12/2020 08:50	25/12/2020 12:25	25/12/2020 08:50	25/12/2020 12:25	3,58	12	42,95	CHI
202012143812	GOIATUBA	BJ21309891	BOM JESUS DE GOIAS	25/12/2020 08:51	25/12/2020 13:20	25/12/2020 08:51	25/12/2020 13:20	4,47	1	4,47	CHI
202012143813	SANTA HELENA DE GOIAS	RV12091973	RIO VERDE S1	25/12/2020 08:52	25/12/2020 12:01	25/12/2020 08:52	25/12/2020 12:01	3,15	9	28,35	CHI
202012143813	RIO VERDE	RV12091973	RIO VERDE S1	25/12/2020 08:52	25/12/2020 12:01	25/12/2020 08:52	25/12/2020 12:01	3,15	3	9,45	CHI
202012143815	MINEIROS	1390073522	PARQUE DAS EMAS	25/12/2020 08:52	25/12/2020 15:08	25/12/2020 08:52	25/12/2020 15:08	6,27	1	6,27	CHI
202012143821	BOM JARDIM DE GOIAS	BM12193386	BOM JARDIM	25/12/2020 08:52	25/12/2020 10:05	25/12/2020 08:52	25/12/2020 10:05	1,20	15	18,03	CHI
202012144140	NOVO PLANALTO	TA12358155	SAO MIGUEL DO ARAGUAIA	25/12/2020 08:52	25/12/2020 12:02	25/12/2020 08:52	25/12/2020 12:02	3,15	16	50,45	CHI
202012144356	CAMPINACU	UC12316380	MARA ROSA	25/12/2020 08:52	25/12/2020 12:13	25/12/2020 08:52	25/12/2020 12:13	3,34	56	186,95	CHI
202012143830	FORMOSA	FA12071048	ITUIQUIRA	25/12/2020 08:54	25/12/2020 15:50	25/12/2020 08:54	25/12/2020 15:50	6,92	14	96,86	CHI
202012143864	APARECIDA DO RIO DOCE	RV12402229	CABRIUVA S2	25/12/2020 08:56	25/12/2020 14:21	25/12/2020 08:56	25/12/2020 14:21	5,41	6	32,47	CHI
202012143864	RIO VERDE	RV12402229	CABRIUVA S2	25/12/2020 08:56	25/12/2020 14:21	25/12/2020 08:56	25/12/2020 14:21	5,41	7	37,88	CHI
202012143952	PANAMA	PX12190957	CACHOEIRA DOURADA	25/12/2020 08:56	25/12/2020 10:41	25/12/2020 08:56	25/12/2020 10:41	1,75	7	12,22	CHI
202012143845	ANICUNS	AC12304531	ANICUNS	25/12/2020 08:57	25/12/2020 10:38	25/12/2020 08:57	25/12/2020 10:38	1,67	5	8,36	CHI
202012143846	CAIAPONIA	JT12358917	JATAI S1	25/12/2020 08:57	25/12/2020 18:14	25/12/2020 08:57	25/12/2020 18:14	9,27	1	9,27	CHI
202012143846	JATAI	JT12358917	JATAI S1	25/12/2020 08:57	25/12/2020 18:14	25/12/2020 08:57	25/12/2020 18:14	9,27	7	64,89	CHI
202012143906	ARAGOIANIA	GA10400770	GUAPO S1	25/12/2020 09:00	25/12/2020 09:12	25/12/2020 09:00	25/12/2020 09:12	0,19	32	6,20	CHI
202012143906	GUAPO	GA10400770	GUAPO S1	25/12/2020 09:00	25/12/2020 09:12	25/12/2020 09:00	25/12/2020 09:12	0,19	230	44,53	CHI
202012143906	VARJAO	GA10400770	GUAPO S1	25/12/2020 09:00	25/12/2020 09:12	25/12/2020 09:00	25/12/2020 09:12	0,19	12	2,32	CHI
202012143867	MINACU	20853946	MINACU	25/12/2020 09:01	25/12/2020 23:23	25/12/2020 09:01	25/12/2020 23:23	14,35	4	57,41	CHI
202012143933	PORANGATU	PO12020611	NOVO PLANALTO	25/12/2020 09:04	25/12/2020 11:32	25/12/2020 09:04	25/12/2020 11:32	2,45	8	19,62	CHI
202012143905	RIO VERDE	RV21023860	RIO VERDE S2	25/12/2020 09:06	25/12/2020 10:59	25/12/2020 09:06	25/12/2020 10:59	1,87	1	1,87	CHI
202012143909	GOIANIA	GN11221767	GOYA S2	25/12/2020 09:06	25/12/2020 11:25	25/12/2020 09:06	25/12/2020 11:25	2,30	131	301,41	CHI
202012144185	AGUA FRIA DE GOIAS	MJ12183873	PADRE BERNARDO	25/12/2020 09:06	25/12/2020 11:35	25/12/2020 09:06	25/12/2020 11:35	2,47	3	7,41	CHI
202012144185	MIMOSO DE GOIAS	MJ12183873	PADRE BERNARDO	25/12/2020 09:06	25/12/2020 11:35	25/12/2020 09:06	25/12/2020 11:35	2,47	10	24,69	CHI
202012143924	FLORES DE GOIAS	FB12044974RE	IACIARA S2	25/12/2020 09:08	25/12/2020 20:54	25/12/2020 09:08	25/12/2020 20:54	11,76	6	70,59	CHI
202012144656	SANTO ANTONIO DA BARRA	EU12207513	ACREUNA	25/12/2020 09:08	25/12/2020 15:47	25/12/2020 09:08	25/12/2020 15:47	6,64	5	33,22	CHI
202012144656	ACREUNA	EU12207513	ACREUNA	25/12/2020 09:08	25/12/2020 15:47	25/12/2020 09:08	25/12/2020 15:47	6,64	2	13,29	CHI
202012143927	VIANOPOLIS	OZ12105255	PIRES DO RIO S2	25/12/2020 09:09	25/12/2020 12:43	25/12/2020 09:09	25/12/2020 12:43	3,56	2	7,13	CHI
202012143927	ORIZONA	OZ12105255	PIRES DO RIO S2	25/12/2020 09:09	25/12/2020 12:43	25/12/2020 09:09	25/12/2020 12:43	3,56	5	17,82	CHI
202012143929	MONTIVIDIU DO NORTE	MX12143686RE	PORANGATU	25/12/2020 09:09	25/12/2020 12:19	25/12/2020 09:09	25/12/2020 12:19	3,16	105	331,92	CHI
202012143938	ARAGARCAS	AG12050708	ARAGARCAS	25/12/2020 09:10	25/12/2020 11:50	25/12/2020 09:10	25/12/2020 11:50	2,67	1	2,67	CHI
202012144016	SANTA CRUZ DE GOIAS	BC12300910	CRISTIANOPOLIS	25/12/2020 09:10	25/12/2020 11:10	25/12/2020 09:10	25/12/2020 11:10	2,00	12	23,97	CHI
202012143941	GOIANIA	GN12000224	AEROPORTO S3	25/12/2020 09:11	25/12/2020 12:20	25/12/2020 09:11	25/12/2020 12:20	3,14	5	15,71	CHI
202012143948	MINEIROS	MY21348933	PARQUE DAS EMAS	25/12/2020 09:12	26/12/2020 09:50	25/12/2020 09:12	26/12/2020 09:50	24,62	1	24,62	CHI
202012143977	COCALZINHO DE GOIAS	ZN12319615	COCALZINHO	25/12/2020 09:15	25/12/2020 16:54	25/12/2020 09:15	25/12/2020 16:54	7,65	22	168,19	CHI
202012144015	FAZENDA NOVA	FN12060693	IPORA	25/12/2020 09:16	25/12/2020 11:54	25/12/2020 09:16	25/12/2020 11:54	2,63	11	28,96	CHI
202012144038	ANAPOLIS	AN12261233	ANAPOLIS UNIVERSITARIO S2	25/12/2020 09:16	25/12/2020 11:01	25/12/2020 09:16	25/12/2020 11:01	1,73	2	3,47	CHI
202012143995	HIDROLANDIA	HD12000067	INDEPENDENCIA S1	25/12/2020 09:21	25/12/2020 12:24	25/12/2020 09:21	25/12/2020 12:24	3,05	11	33,52	CHI
202012143995	ARAGOIANIA	HD12000067	INDEPENDENCIA S1	25/12/2020 09:21	25/12/2020 12:24	25/12/2020 09:21	25/12/2020 12:24	3,05	5	15,23	CHI
202012144228	SERRANOPOLIS	SX12166076	JATAI S1	25/12/2020 09:22	25/12/2020 20:09	25/12/2020 09:22	25/12/2020 20:09	10,78	11	118,60	CHI
202012144138	FAZENDA NOVA	FN12242280	IPORA	25/12/2020 09:26	25/12/2020 11:23	25/12/2020 09:26	25/12/2020 11:23	1,94	8	15,55	CHI
202012144742	MATRINCHA	MP12165389	MOZARLANDIA	25/12/2020 09:27	26/12/2020 01:59	25/12/2020 09:27	26/12/2020 01:59	16,52	5	82,59	CHI
202012144742	ARUANA	MP12165389	MOZARLANDIA	25/12/2020 09:27	26/12/2020 01:59	25/12/2020 09:27	26/12/2020 01:59	16,52	1	16,52	CHI
202012144040	PONTALINA	PK12047371RE	VICENTINOPOLIS	25/12/2020 09:29	25/12/2020 15:00	25/12/2020 09:29	25/12/2020 15:00	5,50	47	258,71	CHI
202012144511	ALEXANIA	AX12384864	ALEXANIA	25/12/2020 09:29	25/12/2020 14:41	25/12/2020 09:29	25/12/2020 14:41	5,19	79	410,03	CHI
202012144046	APARECIDA DE GOIANIA	AP11144595	INDEPENDENCIA S2	25/12/2020 09:30	25/12/2020 12:24	25/12/2020 09:30	25/12/2020 12:24	2,89	255	737,59	CHI
202012144057	INDIARA	IY12230001	CEZARINA	25/12/2020 09:31	25/12/2020 11:48	25/12/2020 09:31	25/12/2020 11:48	2,27	1	2,27	CHI
202012144071	SANTA BARBARA DE GOIAS	SB31005809	TRINDADE	25/12/2020 09:33	25/12/2020 13:55	25/12/2020 09:33	25/12/2020 13:32	3,98	2	7,97	CHI
202012144071	TRINDADE	SB12234175	TRINDADE	25/12/2020 09:33	25/12/2020 13:55	25/12/2020 12:04	25/12/2020 13:55	1,85	1	1,85	CHI

202012144071	SANTA BARBARA DE GOIAS	SB12234175	TRINDADE	25/12/2020 09:33	25/12/2020 13:55	25/12/2020 12:04	25/12/2020 13:55	1,85	11	20,38	CHI
202012144081	FAINA	FC12199793	GOIAS	25/12/2020 09:34	25/12/2020 12:22	25/12/2020 09:34	25/12/2020 12:22	2,80	17	47,52	CHI
202012144083	SANTA FE DE GOIAS	RN12183381	BRITANIA	25/12/2020 09:37	26/12/2020 08:20	25/12/2020 09:37	26/12/2020 08:20	22,70	1	22,70	CHI
202012144090	SAO DOMINGOS	SD12389177	SAO DOMINGOS	25/12/2020 09:38	25/12/2020 11:53	25/12/2020 09:38	25/12/2020 11:53	2,24	64	143,36	CHI
202012144154	SANTA ISABEL	GE12302383	GOIANESIA S1	25/12/2020 09:43	25/12/2020 12:37	25/12/2020 09:43	25/12/2020 12:37	2,89	1	2,89	CHI
202012144154	GOIANESIA	GE12302383	GOIANESIA S1	25/12/2020 09:43	25/12/2020 12:37	25/12/2020 09:43	25/12/2020 12:37	2,89	3	8,66	CHI
202012144145	SILVANIA	SV12330380	DAIA S2	25/12/2020 09:48	25/12/2020 14:37	25/12/2020 09:48	25/12/2020 14:37	4,81	2	9,61	CHI
202012145370	JATAI	JT12125855	JATAI S1	25/12/2020 09:48	25/12/2020 19:24	25/12/2020 09:48	25/12/2020 19:24	9,59	4	38,36	CHI
202012145370	PEROLANDIA	JT12125855	JATAI S1	25/12/2020 09:48	25/12/2020 19:24	25/12/2020 09:48	25/12/2020 19:24	9,59	4	38,36	CHI
202012144150	PLANALTINA	PI12204793	PLANALTINA	25/12/2020 09:49	25/12/2020 14:03	25/12/2020 09:49	25/12/2020 14:03	4,22	117	494,16	CHI
202012144178	SAO JOAO D ALIANCA	JL12264714	SAO JOAO D ALIANCA	25/12/2020 09:52	25/12/2020 10:29	25/12/2020 09:52	25/12/2020 10:29	0,62	33	20,32	CHI
202012144183	FORMOSA	7194593	ITUIQUIRA	25/12/2020 09:53	25/12/2020 11:24	25/12/2020 09:53	25/12/2020 11:24	1,52	41	62,17	CHI
202012179438	JARAGUA	JA12297466LD	JARAGUA	25/12/2020 09:54	27/12/2020 02:02	26/12/2020 12:15	26/12/2020 13:11	0,93	4	3,74	CHI
202012179438	JARAGUA	JA12297466LD	JARAGUA	25/12/2020 09:54	27/12/2020 02:02	25/12/2020 18:27	27/12/2020 01:56	31,47	16	503,49	CHI
202012179438	JARAGUA	JA12297466LD	JARAGUA	25/12/2020 09:54	27/12/2020 02:02	26/12/2020 17:54	27/12/2020 01:56	8,03	4	32,11	CHI
202012179438	JARAGUA	JA10396178	JARAGUA	25/12/2020 09:54	27/12/2020 02:02	25/12/2020 18:27	27/12/2020 01:59	31,53	487	15356,46	CHI
202012179438	URUANA	JA10396200	JARAGUA	25/12/2020 09:54	27/12/2020 02:02	25/12/2020 18:27	27/12/2020 02:02	31,58	7	221,07	CHI
202012179438	ITAGUARU	JA10396200	JARAGUA	25/12/2020 09:54	27/12/2020 02:02	25/12/2020 18:27	27/12/2020 02:02	31,58	26	821,12	CHI
202012179438	JARAGUA	JA10396200	JARAGUA	25/12/2020 09:54	27/12/2020 02:02	25/12/2020 18:27	27/12/2020 02:02	31,58	377	11906,18	CHI
202012179440	JARAGUA	JA21158313	JARAGUA	25/12/2020 09:54	27/12/2020 02:02	25/12/2020 09:54	27/12/2020 02:02	40,15	2	80,29	CHI
202012139490	CAIAPONIA	CP12200873	PALESTINA	25/12/2020 09:55	25/12/2020 12:59	25/12/2020 09:55	25/12/2020 12:59	3,06	98	299,93	CHI
202012144206	CATALAO	CT12077340	CATALAO S1	25/12/2020 09:56	25/12/2020 12:19	25/12/2020 09:56	25/12/2020 12:19	2,37	2	4,73	CHI
202012144209	SAO MIGUEL DO ARAGUAIA	SM12151032	SAO MIGUEL DO ARAGUAIA	25/12/2020 09:57	26/12/2020 00:03	25/12/2020 09:57	26/12/2020 00:03	14,09	9	126,80	CHI
202012144214	QUIRINOPOLIS	QI32036491	QUIRINOPOLIS	25/12/2020 09:58	25/12/2020 13:30	25/12/2020 09:58	25/12/2020 13:30	3,53	5	17,65	CHI
202012144216	ITAPIRAPUA	8707139	MATRINCHA	25/12/2020 09:58	25/12/2020 14:48	25/12/2020 09:58	25/12/2020 14:48	4,82	2	9,64	CHI
202012144217	IPAMERI	IP21107639	IPAMERI	25/12/2020 09:58	25/12/2020 14:08	25/12/2020 09:58	25/12/2020 14:08	4,15	1	4,15	CHI
202012144218	AGUA FRIA DE GOIAS	JL12117446	SAO JOAO D ALIANCA	25/12/2020 09:58	25/12/2020 11:32	25/12/2020 09:58	25/12/2020 11:32	1,55	20	31,05	CHI
202012144218	SAO JOAO D ALIANCA	JL12117446	SAO JOAO D ALIANCA	25/12/2020 09:58	25/12/2020 11:32	25/12/2020 09:58	25/12/2020 11:32	1,55	26	40,37	CHI
202012144227	SANTA CRUZ DE GOIAS	BC12319013	PIRES DO RIO S2	25/12/2020 09:59	25/12/2020 11:32	25/12/2020 09:59	25/12/2020 11:32	1,54	7	10,75	CHI
202012144395	JUSSARA	RN12078427	BRITANIA	25/12/2020 09:59	25/12/2020 21:40	25/12/2020 09:59	25/12/2020 21:40	11,68	3	35,03	CHI
202012144395	SANTA FE DE GOIAS	RN12078427	BRITANIA	25/12/2020 09:59	25/12/2020 21:40	25/12/2020 09:59	25/12/2020 21:40	11,68	2	23,35	CHI
202012144247	INHUMAS	IN12012257	INHUMAS S2	25/12/2020 10:02	25/12/2020 14:37	25/12/2020 10:02	25/12/2020 14:37	4,57	94	429,58	CHI
202012144255	CAIAPONIA	PH12259516	CAIAPONIA	25/12/2020 10:05	27/12/2020 08:18	25/12/2020 18:39	25/12/2020 19:18	0,65	3	1,94	CHI
202012144255	PIRANHAS	PH12259516	CAIAPONIA	25/12/2020 10:05	27/12/2020 08:18	25/12/2020 18:39	25/12/2020 19:18	0,65	62	40,16	CHI
202012144255	PIRANHAS	PH12343552	CAIAPONIA	25/12/2020 10:05	27/12/2020 08:18	25/12/2020 10:05	27/12/2020 08:18	46,21	8	369,71	CHI
202012144260	ANICUNS	AC12000068	ANICUNS	25/12/2020 10:05	25/12/2020 11:40	25/12/2020 10:05	25/12/2020 11:40	1,57	35	55,00	CHI
202012144265	MORRINHOS	MR12029308	GOIATUBA S2	25/12/2020 10:06	25/12/2020 14:30	25/12/2020 10:06	25/12/2020 14:30	4,39	2	8,78	CHI
202012144267	PIRANHAS	PH21204990	PIRANHAS	25/12/2020 10:07	26/12/2020 09:05	25/12/2020 10:07	26/12/2020 09:05	22,96	1	22,96	CHI
202012144278	QUIRINOPOLIS	QI32255692	QUIRINOPOLIS	25/12/2020 10:09	25/12/2020 11:56	25/12/2020 10:09	25/12/2020 11:56	1,78	27	48,15	CHI
202012144282	PIRANHAS	PH12245929	ARENOPOLIS	25/12/2020 10:10	25/12/2020 14:13	25/12/2020 10:10	25/12/2020 14:13	4,04	8	32,34	CHI
202012144288	JANDAIA	PU12205943RE	PARAUNA	25/12/2020 10:11	25/12/2020 12:31	25/12/2020 10:11	25/12/2020 12:31	2,33	3	6,99	CHI
202012144288	PARAUNA	PU12205943RE	PARAUNA	25/12/2020 10:11	25/12/2020 12:31	25/12/2020 10:11	25/12/2020 12:31	2,33	25	58,26	CHI
202012144306	FIRMINOPOLIS	FR12096990	FIRMINOPOLIS S1	25/12/2020 10:12	25/12/2020 12:50	25/12/2020 10:12	25/12/2020 12:50	2,62	6	15,74	CHI
202012144307	MONTIVIDIU	MV12260789	MONTIVIDIU T	25/12/2020 10:12	25/12/2020 11:52	25/12/2020 10:12	25/12/2020 11:52	1,66	2	3,31	CHI
202012144309	EDEIA	EA12000051	EDEIA	25/12/2020 10:12	25/12/2020 11:57	25/12/2020 10:12	25/12/2020 11:57	1,73	2	3,47	CHI
202012144314	MARA ROSA	MQ12115538LD	MARA ROSA	25/12/2020 10:13	25/12/2020 23:47	25/12/2020 10:13	25/12/2020 23:47	13,57	18	244,27	CHI
202012144330	CROMINIA	CQ21000225	PONTALINA	25/12/2020 10:16	25/12/2020 12:54	25/12/2020 10:16	25/12/2020 12:54	2,62	2	5,24	CHI
202012144334	TRINDADE	TR11240503	TRINDADE	25/12/2020 10:18	25/12/2020 15:30	25/12/2020 10:18	25/12/2020 15:30	5,20	24	124,79	CHI
202012144336	GOIANIA	GN11198740	CARAJAS S2	25/12/2020 10:18	25/12/2020 14:32	25/12/2020 10:18	25/12/2020 14:32	4,23	125	528,65	CHI
202012144338	CACHOEIRA ALTA	CA21247852	CACHOEIRA ALTA	25/12/2020 10:18	25/12/2020 14:45	25/12/2020 10:18	25/12/2020 14:45	4,45	1	4,45	CHI
202012144351	SANCLERLANDIA	SC10404261	FIRMINOPOLIS S2	25/12/2020 10:19	25/12/2020 21:15	25/12/2020 10:19	25/12/2020 12:07	1,79	1	1,79	CHI

202012144351	SANCLERLANDIA	SC10396177	FIRMINOPOLIS S2	25/12/2020 10:19	25/12/2020 21:15	25/12/2020 10:19	25/12/2020 21:15	10,93	13	142,03	CHI
202012144457	SAO JOAO D ALIANCA	JL12383335	SAO JOAO D ALIANCA	25/12/2020 10:19	25/12/2020 14:47	25/12/2020 10:19	25/12/2020 14:47	4,45	11	48,99	CHI
202012144593	ABADIANIA	AA12258356	ANAPOLIS UNIVERSITARIO S1	25/12/2020 10:24	25/12/2020 17:46	25/12/2020 10:24	25/12/2020 17:46	7,35	12	88,20	CHI
202012144365	MINEIROS	MY12324503	PARQUE DAS EMAS	25/12/2020 10:25	26/12/2020 09:09	25/12/2020 10:25	26/12/2020 09:09	22,72	2	45,45	CHI
202012144439	TROMBAS	TB12187857	PORANGATU	25/12/2020 10:25	25/12/2020 13:59	25/12/2020 10:25	25/12/2020 13:59	3,57	8	28,52	CHI
202012144377	GOIANIA	GN11001216	GOIANIA LESTE S1	25/12/2020 10:27	25/12/2020 17:04	25/12/2020 11:16	25/12/2020 12:45	1,48	72	106,82	CHI
202012144377	GOIANIA	GN11001216	GOIANIA LESTE S1	25/12/2020 10:27	25/12/2020 17:04	25/12/2020 14:56	25/12/2020 17:03	2,11	72	151,78	CHI
202012144377	GOIANIA	GN11000824	FERROVIARIO S2	25/12/2020 10:27	25/12/2020 17:04	25/12/2020 14:55	25/12/2020 17:04	2,14	124	265,88	CHI
202012144389	BRITANIA	2110018684	BRITANIA	25/12/2020 10:30	25/12/2020 17:30	25/12/2020 10:30	25/12/2020 17:30	6,99	1	6,99	CHI
202012144391	PONTALINA	PK12047065	PONTALINA	25/12/2020 10:30	25/12/2020 13:58	25/12/2020 10:30	25/12/2020 13:58	3,46	10	34,62	CHI
202012144392	LUZIANIA	LZ12330857	RIO VERMELHO	25/12/2020 10:31	25/12/2020 12:27	25/12/2020 10:31	25/12/2020 12:27	1,93	145	280,17	CHI
202012144402	FAZENDA NOVA	FN11349630	IPORA	25/12/2020 10:32	25/12/2020 15:05	25/12/2020 10:32	25/12/2020 15:05	4,54	1	4,54	CHI
202012144405	PALMEIRAS DE GOIAS	PL21186320	PALMEIRAS	25/12/2020 10:32	25/12/2020 13:46	25/12/2020 10:32	25/12/2020 13:46	3,22	1	3,22	CHI
202012144409	CORUMBAIBA	CI12040128	VILA CORUMBA	25/12/2020 10:34	25/12/2020 11:31	25/12/2020 10:34	25/12/2020 11:31	0,94	1	0,94	CHI
202012144816	ITAPACI	IW12350041	RUBIATABA	25/12/2020 10:36	25/12/2020 14:08	25/12/2020 10:36	25/12/2020 14:08	3,52	11	38,76	CHI
202012145717	GOIAS	GS12068553	MATRINCHA	25/12/2020 10:41	25/12/2020 16:41	25/12/2020 10:41	25/12/2020 16:41	5,99	3	17,98	CHI
202012144433	TURVELANDIA	TD12025737	RIO DOS BOIS	25/12/2020 10:42	25/12/2020 12:38	25/12/2020 10:42	25/12/2020 12:38	1,93	66	127,47	CHI
202012144433	SANTA HELENA DE GOIAS	TD12025737	RIO DOS BOIS	25/12/2020 10:42	25/12/2020 12:38	25/12/2020 10:42	25/12/2020 12:38	1,93	18	34,77	CHI
202012144433	ACREUNA	TD12025737	RIO DOS BOIS	25/12/2020 10:42	25/12/2020 12:38	25/12/2020 10:42	25/12/2020 12:38	1,93	26	50,22	CHI
202012144450	CATALAO	CT12203061	CATALAO S1	25/12/2020 10:47	25/12/2020 16:01	25/12/2020 10:47	25/12/2020 16:01	5,23	1	5,23	CHI
202012144507	CACHOEIRA DOURADA	CD12000044	CACHOEIRA DOURADA	25/12/2020 10:48	25/12/2020 12:28	25/12/2020 10:48	25/12/2020 12:28	1,65	10	16,54	CHI
202012144468	SILVANIA	SV12310162	VIANOPOLIS	25/12/2020 10:50	25/12/2020 13:15	25/12/2020 10:50	25/12/2020 13:15	2,40	1	2,40	CHI
202012144552	INACIOLANDIA	CD12000116	CACHOEIRA DOURADA	25/12/2020 10:50	25/12/2020 14:30	25/12/2020 10:50	25/12/2020 14:30	3,66	13	47,63	CHI
202012144873	POSSE	PS12152680	IACIARA S2	25/12/2020 10:53	25/12/2020 13:41	25/12/2020 10:53	25/12/2020 13:41	2,80	10	27,99	CHI
202012145255	GOIAS	GS12021060	GOIAS	25/12/2020 10:54	25/12/2020 14:52	25/12/2020 10:54	25/12/2020 14:52	3,96	3	11,89	CHI
202012144498	PLANALTINA	10002823037	PLANALTINA	25/12/2020 10:57	25/12/2020 15:55	25/12/2020 10:57	25/12/2020 15:55	4,96	1	4,96	CHI
202012144502	SITIO D ABADIA	SI12118074	IACIARA S2	25/12/2020 10:58	25/12/2020 16:00	25/12/2020 10:58	25/12/2020 16:00	5,03	2	10,06	CHI
202012144502	ALVORADA DO NORTE	SI12118074	IACIARA S2	25/12/2020 10:58	25/12/2020 16:00	25/12/2020 10:58	25/12/2020 16:00	5,03	5	25,15	CHI
202012144504	FORMOSA	FA21180869	ITQUIRA	25/12/2020 10:58	25/12/2020 20:34	25/12/2020 10:58	25/12/2020 20:34	9,60	1	9,60	CHI
202012144505	FAZENDA NOVA	FN21141477	IPORA	25/12/2020 10:58	25/12/2020 15:45	25/12/2020 10:58	25/12/2020 15:45	4,77	1	4,77	CHI
202012144525	CRISTALINA	KR10406854	CRISTALINA S2	25/12/2020 10:59	25/12/2020 16:31	25/12/2020 11:02	25/12/2020 12:30	1,48	45	66,69	CHI
202012144525	CRISTALINA	KR13313664	CRISTALINA S2	25/12/2020 10:59	25/12/2020 16:31	25/12/2020 11:02	25/12/2020 13:22	2,34	280	655,20	CHI
202012144525	CRISTALINA	KR10406854	CRISTALINA S2	25/12/2020 10:59	25/12/2020 16:31	25/12/2020 13:42	25/12/2020 14:17	0,58	230	133,08	CHI
202012144525	CRISTALINA	KR10406854	CRISTALINA S2	25/12/2020 10:59	25/12/2020 16:31	25/12/2020 13:42	25/12/2020 15:57	2,25	84	188,72	CHI
202012144525	CRISTALINA	KR12276471	CRISTALINA S2	25/12/2020 10:59	25/12/2020 16:31	25/12/2020 13:42	25/12/2020 16:31	2,81	11	30,96	CHI
202012144537	FORMOSA	FA12053564	ITQUIRA	25/12/2020 11:06	25/12/2020 12:14	25/12/2020 11:06	25/12/2020 12:14	1,13	2	2,27	CHI
202012146412	ITAPIRAPUA	IU12089755	MATRINCHA	25/12/2020 11:06	26/12/2020 07:39	25/12/2020 11:06	26/12/2020 07:39	20,54	56	1150,29	CHI
202012146412	GOIAS	IU12089755	MATRINCHA	25/12/2020 11:06	26/12/2020 07:39	25/12/2020 11:06	26/12/2020 07:39	20,54	1	20,54	CHI
202012144548	PORANGATU	PO12208558	PORANGATU	25/12/2020 11:09	25/12/2020 13:12	25/12/2020 11:09	25/12/2020 13:12	2,05	14	28,67	CHI
202012144759	URUTAI	UT12027112RE	PIRES DO RIO S2	25/12/2020 11:09	25/12/2020 14:47	25/12/2020 11:09	25/12/2020 14:47	3,63	20	72,58	CHI
202012144568	PORANGATU	PO12240217	MARA ROSA	25/12/2020 11:12	25/12/2020 13:21	25/12/2020 11:12	25/12/2020 13:21	2,13	4	8,54	CHI
202012143345	TRINDADE	390010418	INHUMAS S1	25/12/2020 11:15	25/12/2020 17:32	25/12/2020 11:15	25/12/2020 17:32	6,28	1	6,28	CHI
202012144575	PADRE BERNARDO	PB12165002	PADRE BERNARDO	25/12/2020 11:15	25/12/2020 12:25	25/12/2020 11:15	25/12/2020 12:25	1,16	2	2,32	CHI
202012144576	IPORA	IR12014026	IPORA	25/12/2020 11:16	25/12/2020 15:19	25/12/2020 11:16	25/12/2020 15:19	4,05	4	16,19	CHI
202012144578	SAO MIGUEL DO ARAGUAIA	SM11292341	SAO MIGUEL DO ARAGUAIA	25/12/2020 11:16	25/12/2020 14:59	25/12/2020 11:16	25/12/2020 14:59	3,71	49	181,56	CHI
202012144581	QUIRINOPOLIS	QI12054841	QUIRINOPOLIS	25/12/2020 11:17	25/12/2020 16:23	25/12/2020 11:17	25/12/2020 16:23	5,09	17	86,53	CHI
202012144581	PARANAIGUARA	QI12054841	QUIRINOPOLIS	25/12/2020 11:17	25/12/2020 16:23	25/12/2020 11:17	25/12/2020 16:23	5,09	2	10,18	CHI
202012144783	ALEXANIA	AX12353458	ALEXANIA	25/12/2020 11:19	25/12/2020 14:26	25/12/2020 11:19	25/12/2020 14:26	3,11	17	52,87	CHI
202012144606	JATAI	10001443494	JATAI S3	25/12/2020 11:22	25/12/2020 21:41	25/12/2020 11:22	25/12/2020 21:41	10,33	1	10,33	CHI
202012144618	PIRES DO RIO	PR12000096RE	PIRES DO RIO S1	25/12/2020 11:23	25/12/2020 12:48	25/12/2020 11:23	25/12/2020 12:48	1,42	22	31,13	CHI
202012144618	PALMELO	PR12000096RE	PIRES DO RIO S1	25/12/2020 11:23	25/12/2020 12:48	25/12/2020 11:23	25/12/2020 12:48	1,42	6	8,49	CHI

202012144624	FORMOSA	FA21309215	PLANALTIMA	25/12/2020 11:26	25/12/2020 12:43	25/12/2020 11:26	25/12/2020 12:43	1,28	1	1,28	CHI
202012144659	NIQUELANDIA	NQ12239432	URUACU	25/12/2020 11:33	25/12/2020 17:29	25/12/2020 11:33	25/12/2020 17:29	5,93	21	124,58	CHI
202012144885	BALIZA	BH12331383	CAIAPONIA	25/12/2020 11:37	25/12/2020 16:54	25/12/2020 11:37	25/12/2020 16:54	5,28	10	52,77	CHI
202012144668	GOUVELANDIA	GB12271265	QUIRINOPOLIS	25/12/2020 11:41	25/12/2020 13:52	25/12/2020 11:41	25/12/2020 13:52	2,18	4	8,71	CHI
202012144684	LUZIANIA	LZ12370746	RIO VERMELHO	25/12/2020 11:44	25/12/2020 12:15	25/12/2020 11:44	25/12/2020 12:15	0,50	53	26,71	CHI
202012144786	CALDAZINHA	BV12085428	CEPAIGO S2	25/12/2020 11:44	25/12/2020 14:48	25/12/2020 11:44	25/12/2020 14:48	3,06	30	91,73	CHI
202012144689	PARANAIGUARA	PC12000130	QUIRINOPOLIS	25/12/2020 11:46	25/12/2020 14:34	25/12/2020 11:46	25/12/2020 14:34	2,79	7	19,53	CHI
202012144689	QUIRINOPOLIS	PC12000130	QUIRINOPOLIS	25/12/2020 11:46	25/12/2020 14:34	25/12/2020 11:46	25/12/2020 14:34	2,79	8	22,32	CHI
202012146608	GOIATUBA	GT12044907	GOIATUBA S2	25/12/2020 11:49	25/12/2020 20:41	25/12/2020 11:49	25/12/2020 20:41	8,86	14	124,00	CHI
202012144720	SILVANIA	SV12247192	VIANOPOLIS	25/12/2020 11:52	25/12/2020 14:37	25/12/2020 11:52	25/12/2020 14:37	2,75	10	27,50	CHI
202012144744	CACHOEIRA ALTA	80043641	QUIRINOPOLIS	25/12/2020 11:55	25/12/2020 18:37	25/12/2020 11:55	25/12/2020 18:37	6,69	1	6,69	CHI
202012144746	PALMINOPOLIS	PP12233311RE	PALMEIRAS	25/12/2020 11:56	25/12/2020 16:50	25/12/2020 11:56	25/12/2020 16:50	4,89	39	190,64	CHI
202012144746	JANDAIA	PP12233311RE	PALMEIRAS	25/12/2020 11:56	25/12/2020 16:50	25/12/2020 11:56	25/12/2020 16:50	4,89	18	87,99	CHI
202012144755	SANCLERLANDIA	SC12204364	FIRMINOPOLIS S2	25/12/2020 11:58	25/12/2020 14:08	25/12/2020 11:58	25/12/2020 14:08	2,15	2	4,31	CHI
202012144986	MUNDO NOVO DE GOIAS	NA12059971	NOVA CRIXAS	25/12/2020 11:58	25/12/2020 15:28	25/12/2020 11:58	25/12/2020 15:28	3,50	5	17,49	CHI
202012144899	CALDAS NOVAS	CN12246648	SERRA DE CALDAS	25/12/2020 12:00	25/12/2020 19:32	25/12/2020 15:24	25/12/2020 16:23	0,98	58	56,81	CHI
202012144899	CALDAS NOVAS	CN11246579	SERRA DE CALDAS	25/12/2020 12:00	25/12/2020 19:32	25/12/2020 15:32	25/12/2020 19:32	4,00	99	396,03	CHI
202012144803	MORRINHOS	MR10414953	MORRINHOS	25/12/2020 12:12	25/12/2020 15:34	25/12/2020 12:12	25/12/2020 13:25	1,22	118	144,19	CHI
202012144803	MORRINHOS	MR16411558	MORRINHOS	25/12/2020 12:12	25/12/2020 15:34	25/12/2020 12:12	25/12/2020 13:26	1,23	260	319,58	CHI
202012144803	IPAMERI	MR16411558	MORRINHOS	25/12/2020 12:12	25/12/2020 15:34	25/12/2020 12:12	25/12/2020 13:26	1,23	1	1,23	CHI
202012144803	MORRINHOS	MR13122193	MORRINHOS	25/12/2020 12:12	25/12/2020 15:34	25/12/2020 12:12	25/12/2020 14:51	2,65	22	58,29	CHI
202012144803	MORRINHOS	MR10414953	MORRINHOS	25/12/2020 12:12	25/12/2020 15:34	25/12/2020 12:12	25/12/2020 14:51	2,65	35	92,73	CHI
202012144803	MORRINHOS	MR12000343	MORRINHOS	25/12/2020 12:12	25/12/2020 15:34	25/12/2020 14:53	25/12/2020 15:34	0,68	4	2,72	CHI
202012144801	NIQUELANDIA	NQ12330279	NIQUELANDIA SUBTRANSMISSAO	25/12/2020 12:15	25/12/2020 14:12	25/12/2020 12:15	25/12/2020 14:12	1,95	4	7,78	CHI
202012144817	BOM JARDIM DE GOIAS	BM12193386	BOM JARDIM	25/12/2020 12:16	25/12/2020 15:25	25/12/2020 12:16	25/12/2020 15:25	3,15	15	47,19	CHI
202012144818	LUZIANIA	LZ12335757	VIANOPOLIS	25/12/2020 12:20	26/12/2020 13:41	25/12/2020 12:20	26/12/2020 13:41	25,35	3	76,06	CHI
202012145106	SERRANOPOLIS	MY12278397	PARQUE DAS EMAS	25/12/2020 12:21	25/12/2020 21:40	25/12/2020 12:21	25/12/2020 21:40	9,32	7	65,21	CHI
202012145106	MINEIROS	MY12278397	PARQUE DAS EMAS	25/12/2020 12:21	25/12/2020 21:40	25/12/2020 12:21	25/12/2020 21:40	9,32	5	46,58	CHI
202012144825	GOIANIA	GN11189664	GOIANIA LESTE S2	25/12/2020 12:22	25/12/2020 14:51	25/12/2020 14:09	25/12/2020 14:51	0,70	43	30,10	CHI
202012144826	ANAPOLIS	20083361	ANAPOLIS UNIVERSITARIO S2	25/12/2020 12:22	25/12/2020 19:51	25/12/2020 12:22	25/12/2020 19:51	7,49	1	7,49	CHI
202012144843	GOIANIA	GN12000242	GOIANIA LESTE S1	25/12/2020 12:26	26/12/2020 02:26	25/12/2020 12:26	26/12/2020 02:26	13,99	138	1930,43	CHI
202012144967	MORRINHOS	MR12172969	MORRINHOS	25/12/2020 12:30	25/12/2020 14:16	25/12/2020 12:30	25/12/2020 14:16	1,75	200	350,89	CHI
202012144889	POSSE	PS12235239	IACIARA S2	25/12/2020 12:33	25/12/2020 14:49	25/12/2020 12:33	25/12/2020 14:49	2,25	2	4,50	CHI
202012144902	CRISTALINA	KR12488527	CRISTALINA S2	25/12/2020 12:38	25/12/2020 14:37	25/12/2020 12:38	25/12/2020 14:37	1,98	2	3,97	CHI
202012144907	PIRES DO RIO	PR12402554	PIRES DO RIO S1	25/12/2020 12:38	25/12/2020 18:07	25/12/2020 12:38	25/12/2020 18:07	5,48	4	21,91	CHI
202012145418	BARRO ALTO	BA12210719	GOIANESIA S1	25/12/2020 12:41	25/12/2020 17:04	25/12/2020 12:41	25/12/2020 17:04	4,38	1	4,38	CHI
202012145418	VILA PROPICIO	BA12210719	GOIANESIA S1	25/12/2020 12:41	25/12/2020 17:04	25/12/2020 12:41	25/12/2020 17:04	4,38	17	74,38	CHI
202012144915	BOM JARDIM DE GOIAS	BM12155744	BOM JARDIM	25/12/2020 12:42	25/12/2020 17:25	25/12/2020 12:42	25/12/2020 17:25	4,71	4	18,83	CHI
202012145520	ITABERAI	IB12075677	ARACU	25/12/2020 12:43	26/12/2020 00:18	25/12/2020 12:43	26/12/2020 00:18	11,59	18	208,66	CHI
202012145836	CACHOEIRA DOURADA	CD21000037	CACHOEIRA DOURADA	25/12/2020 12:46	25/12/2020 19:15	25/12/2020 12:46	25/12/2020 19:15	6,47	1	6,47	CHI
202012144939	COCALZINHO DE GOIAS	ZN12402010RE	COCALZINHO	25/12/2020 12:48	25/12/2020 16:54	25/12/2020 12:48	25/12/2020 16:54	4,09	136	556,88	CHI
202012144939	VILA PROPICIO	ZN12402010RE	COCALZINHO	25/12/2020 12:48	25/12/2020 16:54	25/12/2020 12:48	25/12/2020 16:54	4,09	1	4,09	CHI
202012144941	MAIRIPOTABA	MI12000430	PONTALINA	25/12/2020 12:48	25/12/2020 17:27	25/12/2020 12:48	25/12/2020 17:27	4,64	3	13,93	CHI
202012144952	BRITANIA	BT12262087	BRITANIA	25/12/2020 12:51	25/12/2020 17:08	25/12/2020 12:51	25/12/2020 17:08	4,28	1	4,28	CHI
202012146721	AMARALINA	LC12230319	NOVA CRIXAS	25/12/2020 12:52	26/12/2020 19:58	25/12/2020 12:52	26/12/2020 19:58	31,10	3	93,30	CHI
202012144957	SAO DOMINGOS	SD12254354	SAO DOMINGOS	25/12/2020 12:53	25/12/2020 16:46	25/12/2020 12:53	25/12/2020 16:46	3,88	5	19,39	CHI
202012144965	ITARUMA	IM12188975	ITAJA S2	25/12/2020 12:55	25/12/2020 17:15	25/12/2020 12:55	25/12/2020 17:15	4,35	11	47,80	CHI
202012144968	CALDAZINHA	LB12270662	DAIA S2	25/12/2020 12:56	26/12/2020 18:42	25/12/2020 12:56	26/12/2020 18:42	29,75	62	1844,79	CHI
202012144968	SILVANIA	LB12270662	DAIA S2	25/12/2020 12:56	26/12/2020 18:42	25/12/2020 12:56	26/12/2020 18:42	29,75	56	1666,26	CHI
202012144968	BELA VISTA DE GOIAS	LB12270662	DAIA S2	25/12/2020 12:56	26/12/2020 18:42	25/12/2020 12:56	26/12/2020 18:42	29,75	1	29,75	CHI
202012144968	LEOPOLDO DE BULHOES	LB12270662	DAIA S2	25/12/2020 12:56	26/12/2020 18:42	25/12/2020 12:56	26/12/2020 18:42	29,75	7	208,28	CHI

202012144968	SILVANIA	LB12270662	DAIA S2	25/12/2020 12:56	26/12/2020 18:42	25/12/2020 17:10	26/12/2020 18:42	25,53	3	76,60	CHI
202012144968	LEOPOLDO DE BULHOES	LB12270662	DAIA S2	25/12/2020 12:56	26/12/2020 18:42	25/12/2020 17:10	26/12/2020 18:42	25,53	2	51,07	CHI
202012144968	CALDAZINHA	LB12270662	DAIA S2	25/12/2020 12:56	26/12/2020 18:42	25/12/2020 17:10	26/12/2020 18:42	25,53	7	178,73	CHI
202012145149	SAO LUIS DE MONTES BELOS	SL12277684	SAO LUIZ DOS MONTES BELOS	25/12/2020 13:00	25/12/2020 18:54	25/12/2020 13:00	25/12/2020 15:55	2,92	116	338,43	CHI
202012145149	SAO LUIS DE MONTES BELOS	SL11260029	SAO LUIZ DOS MONTES BELOS	25/12/2020 13:00	25/12/2020 18:54	25/12/2020 13:00	25/12/2020 18:54	5,91	134	791,38	CHI
202012144997	CATALAO	CT12231540RE	CATALAO S1	25/12/2020 13:04	25/12/2020 17:26	25/12/2020 13:04	25/12/2020 17:26	4,36	11	47,96	CHI
202012145019	ANAPOLIS	AN12321084	ANAPOLIS UNIVERSITARIO S1	25/12/2020 13:06	25/12/2020 15:42	25/12/2020 13:06	25/12/2020 15:42	2,59	7	18,16	CHI
202012145632	TURVELANDIA	TD12025721	RIO DOS BOIS	25/12/2020 13:06	25/12/2020 22:03	25/12/2020 13:06	25/12/2020 18:47	5,68	14	79,46	CHI
202012145632	ACREUNA	TD12025721	RIO DOS BOIS	25/12/2020 13:06	25/12/2020 22:03	25/12/2020 13:06	25/12/2020 18:47	5,68	3	17,03	CHI
202012145632	TURVELANDIA	TD12025721	RIO DOS BOIS	25/12/2020 13:06	25/12/2020 22:03	25/12/2020 13:06	25/12/2020 21:02	7,93	2	15,87	CHI
202012145632	TURVELANDIA	TD12025721	RIO DOS BOIS	25/12/2020 13:06	25/12/2020 22:03	25/12/2020 13:06	25/12/2020 22:03	8,94	19	169,93	CHI
202012145632	ACREUNA	TD12025721	RIO DOS BOIS	25/12/2020 13:06	25/12/2020 22:03	25/12/2020 13:06	25/12/2020 22:03	8,94	18	160,99	CHI
202012145010	BELA VISTA DE GOIAS	BV12086489	CEPAIGO S2	25/12/2020 13:09	25/12/2020 14:31	25/12/2020 13:09	25/12/2020 14:31	1,37	13	17,77	CHI
202012145010	SILVANIA	BV12086489	CEPAIGO S2	25/12/2020 13:09	25/12/2020 14:31	25/12/2020 13:09	25/12/2020 14:31	1,37	1	1,37	CHI
202012145018	JAUPACI	JP12251552	IPORA	25/12/2020 13:11	25/12/2020 17:38	25/12/2020 13:11	25/12/2020 17:38	4,44	1	4,44	CHI
202012145021	SILVANIA	SV12282723	VIANOPOLIS	25/12/2020 13:12	25/12/2020 15:50	25/12/2020 13:12	25/12/2020 15:50	2,63	6	15,76	CHI
202012145209	DOVERLANDIA	DV12259474	CAIAPONIA	25/12/2020 13:13	26/12/2020 14:15	25/12/2020 13:13	26/12/2020 14:15	25,03	38	951,10	CHI
202012145566	AGUA FRIA DE GOIAS	MU12320111	PADRE BERNARDO	25/12/2020 13:15	25/12/2020 17:25	25/12/2020 13:15	25/12/2020 17:25	4,15	9	37,38	CHI
202012145035	JARAGUA	JA12234242	JARAGUA	25/12/2020 13:16	25/12/2020 13:29	25/12/2020 13:16	25/12/2020 13:29	0,22	15	3,36	CHI
202012145105	SILVANIA	SV12199936	VIANOPOLIS	25/12/2020 13:17	25/12/2020 15:54	25/12/2020 13:17	25/12/2020 15:54	2,61	14	36,59	CHI
202012145247	PARAUNA	PU12000022	PARAUNA	25/12/2020 13:18	25/12/2020 15:57	25/12/2020 13:18	25/12/2020 15:57	2,65	184	487,55	CHI
202012145110	BELA VISTA DE GOIAS	SQ12066258	BELA VISTA S1	25/12/2020 13:19	25/12/2020 16:31	25/12/2020 13:19	25/12/2020 16:31	3,20	11	35,20	CHI
202012145051	EDEALINA	EA12058626	PONTALINA	25/12/2020 13:20	25/12/2020 15:39	25/12/2020 13:20	25/12/2020 15:39	2,31	14	32,38	CHI
202012145056	CORUMBA DE GOIAS	CB21130824	CORUMBA	25/12/2020 13:22	25/12/2020 16:52	25/12/2020 13:22	25/12/2020 16:52	3,49	1	3,49	CHI
202012145285	PIRES DO RIO	PR12000096RE	PIRES DO RIO S1	25/12/2020 13:24	25/12/2020 15:47	25/12/2020 13:24	25/12/2020 15:47	2,37	22	52,08	CHI
202012145285	PALMELO	PR12000096RE	PIRES DO RIO S1	25/12/2020 13:24	25/12/2020 15:47	25/12/2020 13:24	25/12/2020 15:47	2,37	6	14,20	CHI
202012145061	ABADIANIA	AA21127346	CORUMBA	25/12/2020 13:25	25/12/2020 16:54	25/12/2020 13:25	25/12/2020 16:54	3,50	1	3,50	CHI
202012145067	JATAI	290180170	JATAI S2	25/12/2020 13:25	25/12/2020 18:45	25/12/2020 13:25	25/12/2020 18:45	5,32	1	5,32	CHI
202012145188	GOIANESIA	GE12255984	GOIANESIA S2	25/12/2020 13:25	25/12/2020 16:22	25/12/2020 13:25	25/12/2020 16:22	2,95	19	56,00	CHI
202012145618	QUIRINOPOLIS	QI32255692	QUIRINOPOLIS	25/12/2020 13:25	25/12/2020 19:06	25/12/2020 13:25	25/12/2020 19:06	5,67	17	96,42	CHI
202012145068	CRISTALINA	KR12171587	CRISTALINA S2	25/12/2020 13:26	25/12/2020 19:01	25/12/2020 13:26	25/12/2020 19:01	5,58	1	5,58	CHI
202012145078	LUZIANIA	LZ12370746	RIO VERMELHO	25/12/2020 13:30	25/12/2020 17:14	25/12/2020 13:30	25/12/2020 17:14	3,73	53	197,76	CHI
202012145201	APARECIDA DE GOIANIA	AP12055193	INDEPENDENCIA S2	25/12/2020 13:31	25/12/2020 15:23	25/12/2020 13:31	25/12/2020 15:23	1,88	435	816,83	CHI
202012145093	ABADIANIA	AA21295617	DAIA S2	25/12/2020 13:32	25/12/2020 15:10	25/12/2020 13:32	25/12/2020 15:10	1,62	1	1,62	CHI
202012145091	SAO DOMINGOS	GH12156343RE	SAO DOMINGOS	25/12/2020 13:33	25/12/2020 16:04	25/12/2020 13:33	25/12/2020 16:04	2,50	1	2,50	CHI
202012145091	MONTE ALEGRE DE GOIAS	GH12156343RE	SAO DOMINGOS	25/12/2020 13:33	25/12/2020 16:04	25/12/2020 13:33	25/12/2020 16:04	2,50	15	37,52	CHI
202012145091	DIVINOPOLIS DE GOIAS	GH12156343RE	SAO DOMINGOS	25/12/2020 13:33	25/12/2020 16:04	25/12/2020 13:33	25/12/2020 16:04	2,50	127	317,71	CHI
202012145097	ITUMBIARA	IT12121122	ITUMBIARA NOVA	25/12/2020 13:34	25/12/2020 18:05	25/12/2020 13:34	25/12/2020 18:05	4,50	1	4,50	CHI
202012145097	PANAMA	IT12121122	ITUMBIARA NOVA	25/12/2020 13:34	25/12/2020 18:05	25/12/2020 13:34	25/12/2020 18:05	4,50	1	4,50	CHI
202012145204	GOIATUBA	GT12263957	BOM JESUS DE GOIAS	25/12/2020 13:37	25/12/2020 22:19	25/12/2020 13:37	25/12/2020 22:19	8,69	5	43,47	CHI
202012145156	QUIRINOPOLIS	QI12050368	QUIRINOPOLIS	25/12/2020 13:38	25/12/2020 16:25	25/12/2020 13:38	25/12/2020 16:25	2,77	32	88,68	CHI
202012145156	CASTELANDIA	QI12050368	QUIRINOPOLIS	25/12/2020 13:38	25/12/2020 16:25	25/12/2020 13:38	25/12/2020 16:25	2,77	1	2,77	CHI
202012145117	GOIANIA	GN11246235	GOIANIA LESTE S3	25/12/2020 13:39	25/12/2020 15:56	25/12/2020 15:23	25/12/2020 15:56	0,55	8	4,40	CHI
202012145143	TRES RANCHOS	TH12068480	CATALAO S1	25/12/2020 13:40	25/12/2020 15:40	25/12/2020 13:40	25/12/2020 15:40	2,00	12	23,95	CHI
202012145135	JUSSARA	JR12019908	JUSSARA	25/12/2020 13:41	26/12/2020 09:14	25/12/2020 13:41	26/12/2020 09:14	19,55	4	78,19	CHI
202012145138	LUZIANIA	LZ11383062	MARAJOARA	25/12/2020 13:45	25/12/2020 17:10	25/12/2020 13:45	25/12/2020 17:10	3,41	148	504,43	CHI
202012145146	PLANALTINA	PI12361252	PLANALTINA	25/12/2020 13:48	25/12/2020 15:35	25/12/2020 13:48	25/12/2020 15:35	1,77	34	60,33	CHI
202012145182	MOSSAMEDES	KB12382583	ANICUNS	25/12/2020 13:49	25/12/2020 15:56	25/12/2020 13:49	25/12/2020 15:56	2,11	17	35,89	CHI
202012145160	ANAPOLIS	AN12262491	ANAPOLIS UNIVERSITARIO S1	25/12/2020 13:54	25/12/2020 15:16	25/12/2020 13:54	25/12/2020 15:16	1,36	40	54,38	CHI
202012145167	CAMPOS BELOS	CH12383368LD	SAO DOMINGOS	25/12/2020 13:55	25/12/2020 23:51	25/12/2020 19:49	25/12/2020 23:31	3,70	254	940,15	CHI
202012145167	CAMPOS BELOS	CH11261945	SAO DOMINGOS	25/12/2020 13:55	25/12/2020 23:51	25/12/2020 13:55	25/12/2020 23:51	9,92	79	783,61	CHI

202012145343	PANAMA	PX12190957	CACHOEIRA DOURADA	25/12/2020 13:55	25/12/2020 17:11	25/12/2020 13:55	25/12/2020 17:11	3,25	7	22,78	CHI
202012145423	GOIANESIA	GE12115122	GOIANESIA S2	25/12/2020 13:55	25/12/2020 17:25	25/12/2020 13:55	25/12/2020 17:25	3,49	25	87,35	CHI
202012145545	FAZENDA NOVA	FN12242280	IPORA	25/12/2020 13:55	25/12/2020 19:19	25/12/2020 13:55	25/12/2020 19:19	5,39	8	43,14	CHI
202012145175	JARAGUA	JA12000117	JARAGUA	25/12/2020 13:59	25/12/2020 16:48	25/12/2020 13:59	25/12/2020 16:48	2,81	3	8,42	CHI
202012145864	BRAZABRANTES	DL12027274	INHUMAS S1	25/12/2020 14:00	25/12/2020 19:32	25/12/2020 14:00	25/12/2020 19:32	5,53	22	121,73	CHI
202012145312	PIRENOPOLIS	JA12059976	JARAGUA	25/12/2020 14:01	25/12/2020 17:33	25/12/2020 14:01	25/12/2020 17:33	3,53	97	342,03	CHI
202012145312	JARAGUA	JA12059976	JARAGUA	25/12/2020 14:01	25/12/2020 17:33	25/12/2020 14:01	25/12/2020 17:33	3,53	2	7,05	CHI
202012145185	JANDAIA	JD21401176	PALMEIRAS	25/12/2020 14:02	25/12/2020 15:11	25/12/2020 14:02	25/12/2020 15:11	1,15	1	1,15	CHI
202012145187	CACHOEIRA DOURADA	CD12389716	CACHOEIRA DOURADA	25/12/2020 14:03	26/12/2020 03:28	25/12/2020 14:03	25/12/2020 18:20	4,29	90	385,83	CHI
202012145187	CACHOEIRA DOURADA	CD12389716	CACHOEIRA DOURADA	25/12/2020 14:03	26/12/2020 03:28	25/12/2020 14:03	26/12/2020 03:28	13,42	3	40,27	CHI
202012145202	SANTO ANTONIO DA BARRA	BZ12207151	ACREUNA	25/12/2020 14:09	25/12/2020 21:21	25/12/2020 14:09	25/12/2020 21:21	7,19	9	64,69	CHI
202012149721	ITAPIRAPUA	IU12067919	MATRINCHA	25/12/2020 14:10	26/12/2020 15:14	25/12/2020 14:10	26/12/2020 15:14	25,06	8	200,48	CHI
202012145231	RIO QUENTE	RQ12100108	RIO QUENTE	25/12/2020 14:11	25/12/2020 18:40	25/12/2020 14:11	25/12/2020 18:40	4,48	8	35,84	CHI
202012145409	GUARANI DE GOIAS	GY12208847	IACIARA S1	25/12/2020 14:11	25/12/2020 16:49	25/12/2020 14:11	25/12/2020 16:49	2,62	817	2141,45	CHI
202012145227	CAIAPONIA	CP12344730	CAIAPONIA	25/12/2020 14:15	26/12/2020 12:11	25/12/2020 14:15	26/12/2020 12:11	21,93	4	87,73	CHI
202012145229	SANTA RITA DO ARAGUAIA	SU12027942	SANTA RITA DO ARAGUAIA	25/12/2020 14:15	26/12/2020 09:26	25/12/2020 14:15	26/12/2020 09:26	19,17	1	19,17	CHI
202012145230	ARAGUAPAZ	AZ12057507	GOIAS	25/12/2020 14:15	26/12/2020 17:48	25/12/2020 14:15	26/12/2020 17:48	27,55	19	523,47	CHI
202012145500	JARAGUA	GE12000255	GOIANESIA S2	25/12/2020 14:20	25/12/2020 23:44	25/12/2020 14:20	25/12/2020 23:44	9,40	5	46,98	CHI
202012145500	GOIANESIA	GE12000255	GOIANESIA S2	25/12/2020 14:20	25/12/2020 23:44	25/12/2020 14:20	25/12/2020 23:44	9,40	3	28,19	CHI
202012145245	CALDAS NOVAS	PJ12263075	CALDAS NOVAS S1	25/12/2020 14:21	25/12/2020 15:53	25/12/2020 14:21	25/12/2020 15:53	1,53	5	7,64	CHI
202012145786	MONTES CLAROS DE GOIAS	JR12212887	IPORA	25/12/2020 14:22	26/12/2020 12:12	25/12/2020 14:22	26/12/2020 12:12	21,83	7	152,80	CHI
202012145786	JUSSARA	JR12212887	IPORA	25/12/2020 14:22	26/12/2020 12:12	25/12/2020 14:22	26/12/2020 12:12	21,83	22	480,22	CHI
202012145257	ARAGUAPAZ	AZ12217609	GOIAS	25/12/2020 14:23	26/12/2020 11:14	25/12/2020 14:23	26/12/2020 11:14	20,84	2	41,69	CHI
202012145263	MINEIROS	MY12296320RE	PARQUE DAS EMAS	25/12/2020 14:24	25/12/2020 19:19	25/12/2020 14:24	25/12/2020 19:19	4,92	11	54,11	CHI
202012145556	JATAI	JT12355226	JATAI S1	25/12/2020 14:24	25/12/2020 22:02	25/12/2020 14:24	25/12/2020 22:02	7,62	5	38,11	CHI
202012145747	GAMELEIRA DE GOIAS	LB12000008	DAIA S2	25/12/2020 14:30	25/12/2020 23:03	25/12/2020 14:30	25/12/2020 23:03	8,54	16	136,68	CHI
202012145747	SILVANIA	LB12000008	DAIA S2	25/12/2020 14:30	25/12/2020 23:03	25/12/2020 14:30	25/12/2020 23:03	8,54	98	837,14	CHI
202012145747	LEOPOLDO DE BULHOES	LB12000008	DAIA S2	25/12/2020 14:30	25/12/2020 23:03	25/12/2020 14:30	25/12/2020 23:03	8,54	159	1358,21	CHI
202012145280	CACHOEIRA DOURADA	CD21000340	CACHOEIRA DOURADA	25/12/2020 14:33	25/12/2020 18:03	25/12/2020 14:33	25/12/2020 18:03	3,49	1	3,49	CHI
202012145291	ITUMBIARA	IT12304246	ITUMBIARA NOVA	25/12/2020 14:36	25/12/2020 19:27	25/12/2020 14:36	25/12/2020 19:27	4,83	3	14,50	CHI
202012145294	ACREUNA	EU12301577	ACREUNA	25/12/2020 14:37	25/12/2020 18:16	25/12/2020 14:37	25/12/2020 18:16	3,64	1	3,64	CHI
202012145373	ARAGARCAS	AG11052637	ARAGARCAS	25/12/2020 14:37	25/12/2020 16:54	25/12/2020 16:33	25/12/2020 16:54	0,35	90	31,90	CHI
202012145297	FORMOSA	FA11342527	ITUIQUIRA	25/12/2020 14:38	25/12/2020 17:02	25/12/2020 14:38	25/12/2020 17:02	2,40	93	222,99	CHI
202012145305	PEROLANDIA	DP12210071	JATAI S1	25/12/2020 14:40	25/12/2020 18:15	25/12/2020 14:40	25/12/2020 18:15	3,58	2	7,16	CHI
202012145319	IVOLANDIA	IV12334659	IPORA	25/12/2020 14:42	25/12/2020 20:23	25/12/2020 14:42	25/12/2020 20:23	5,67	2	11,34	CHI
202012145688	RIO VERDE	RV12301462	ACREUNA	25/12/2020 14:42	25/12/2020 22:57	25/12/2020 14:42	25/12/2020 22:57	8,24	3	24,73	CHI
202012145688	SANTO ANTONIO DA BARRA	RV12301462	ACREUNA	25/12/2020 14:42	25/12/2020 22:57	25/12/2020 14:42	25/12/2020 22:57	8,24	1	8,24	CHI
202012145326	FAZENDA NOVA	FN21141465	JUSSARA	25/12/2020 14:45	25/12/2020 17:10	25/12/2020 14:45	25/12/2020 17:10	2,41	1	2,41	CHI
202012145596	DOVERLANDIA	DV12171957	CAIAPONIA	25/12/2020 14:46	26/12/2020 15:38	25/12/2020 14:46	26/12/2020 15:38	24,86	24	596,63	CHI
202012145340	BOM JARDIM DE GOIAS	BM12201516	BOM JARDIM	25/12/2020 14:47	25/12/2020 17:32	25/12/2020 14:47	25/12/2020 17:32	2,75	40	110,07	CHI
202012145440	PARANAIGUARA	PC12000130	QUIRINOPOLIS	25/12/2020 14:53	25/12/2020 17:01	25/12/2020 14:53	25/12/2020 17:01	2,12	8	16,99	CHI
202012145440	QUIRINOPOLIS	PC12000130	QUIRINOPOLIS	25/12/2020 14:53	25/12/2020 17:01	25/12/2020 14:53	25/12/2020 17:01	2,12	8	16,99	CHI
202012145368	CACU	CC13350892	CACHOEIRA ALTA	25/12/2020 14:54	26/12/2020 22:44	25/12/2020 14:54	25/12/2020 19:33	4,66	1	4,66	CHI
202012145368	ITAJA	IM13158546	CACHOEIRA ALTA	25/12/2020 14:54	26/12/2020 22:44	25/12/2020 14:54	26/12/2020 01:21	10,45	7	73,13	CHI
202012145368	ITARUMA	IM13158546	CACHOEIRA ALTA	25/12/2020 14:54	26/12/2020 22:44	25/12/2020 14:54	26/12/2020 01:21	10,45	81	846,20	CHI
202012145368	CACU	CC13350892	CACHOEIRA ALTA	25/12/2020 14:54	26/12/2020 22:44	25/12/2020 14:54	26/12/2020 09:52	18,97	46	872,68	CHI
202012145368	CACU	CC13350892	CACHOEIRA ALTA	25/12/2020 14:54	26/12/2020 22:44	25/12/2020 14:54	26/12/2020 13:09	22,26	1	22,26	CHI
202012145368	CACU	CC13350892	CACHOEIRA ALTA	25/12/2020 14:54	26/12/2020 22:44	25/12/2020 14:54	26/12/2020 22:44	31,85	1	31,85	CHI
202012146653	QUIRINOPOLIS	CC10394736	CACHOEIRA ALTA	25/12/2020 14:54	26/12/2020 14:09	25/12/2020 19:28	25/12/2020 21:15	1,78	1	1,78	CHI
202012146653	CACU	CC10394736	CACHOEIRA ALTA	25/12/2020 14:54	26/12/2020 14:09	25/12/2020 19:28	25/12/2020 21:15	1,78	394	701,54	CHI
202012146653	CACU	CC10394736	CACHOEIRA ALTA	25/12/2020 14:54	26/12/2020 14:09	25/12/2020 20:45	25/12/2020 21:15	0,49	6	2,94	CHI



202012146653	CACU	CC10394736	CACHOEIRA ALTA	25/12/2020 14:54	26/12/2020 14:09	25/12/2020 22:46	25/12/2020 22:55	0,16	400	62,44	CHI
202012146653	QUIRINOPOLIS	CC10394736	CACHOEIRA ALTA	25/12/2020 14:54	26/12/2020 14:09	25/12/2020 22:46	25/12/2020 22:55	0,16	1	0,16	CHI
202012146653	CACU	CC10394736	CACHOEIRA ALTA	25/12/2020 14:54	26/12/2020 14:09	25/12/2020 19:28	26/12/2020 10:18	14,83	18	266,86	CHI
202012146653	CACU	CC10394736	CACHOEIRA ALTA	25/12/2020 14:54	26/12/2020 14:09	25/12/2020 20:45	26/12/2020 13:09	16,40	1	16,40	CHI
202012146653	CACU	CC12350891	CACHOEIRA ALTA	25/12/2020 14:54	26/12/2020 14:09	25/12/2020 14:54	26/12/2020 14:09	23,25	6	139,50	CHI
202012145381	PEROLANDIA	DP12240335	JATAI S1	25/12/2020 14:56	26/12/2020 08:55	25/12/2020 14:56	26/12/2020 08:55	17,98	2	35,96	CHI
202012145397	FAINA	FC21299863	GOIAS	25/12/2020 14:59	26/12/2020 11:07	25/12/2020 14:59	26/12/2020 10:27	19,46	1	19,46	CHI
202012145397	FAINA	FC12061015	GOIAS	25/12/2020 14:59	26/12/2020 11:07	26/12/2020 08:06	26/12/2020 11:07	3,02	6	18,15	CHI
202012145529	DOVERLANDIA	DV12188456	CAIAPONIA	25/12/2020 14:59	26/12/2020 13:09	25/12/2020 14:59	26/12/2020 13:09	22,18	2	44,36	CHI
202012145411	SANTA HELENA DE GOIAS	400151455	IPEGUARI	25/12/2020 15:02	25/12/2020 18:03	25/12/2020 15:02	25/12/2020 18:03	3,02	1	3,02	CHI
202012145416	CATALAO	CT12266190	CATALAO S1	25/12/2020 15:03	25/12/2020 17:14	25/12/2020 15:03	25/12/2020 17:14	2,17	4	8,67	CHI
202012145479	HIDROLANDIA	HD32097471	CEPAIGO S2	25/12/2020 15:03	25/12/2020 23:43	25/12/2020 15:03	25/12/2020 23:43	8,65	4	34,60	CHI
202012145422	FAZENDA NOVA	FN12060693	IPORA	25/12/2020 15:04	26/12/2020 11:56	25/12/2020 15:04	26/12/2020 11:56	20,85	11	229,40	CHI
202012145920	INHUMAS	IN12320360	INHUMAS S2	25/12/2020 15:04	25/12/2020 20:11	25/12/2020 15:04	25/12/2020 20:11	5,10	101	515,21	CHI
202012145437	INDIARA	IY12039705	EDEIA	25/12/2020 15:07	25/12/2020 18:39	25/12/2020 15:07	25/12/2020 18:39	3,53	3	10,60	CHI
202012145437	ACREUNA	IY12039705	EDEIA	25/12/2020 15:07	25/12/2020 18:39	25/12/2020 15:07	25/12/2020 18:39	3,53	7	24,73	CHI
202012145497	LEOPOLDO DE BULHOES	LB12311926	DAIA S2	25/12/2020 15:08	25/12/2020 20:14	25/12/2020 15:08	25/12/2020 20:14	5,09	23	117,03	CHI
202012145449	CALDAS NOVAS	CN12311854	CALDAS NOVAS S1	25/12/2020 15:10	25/12/2020 23:16	25/12/2020 15:10	25/12/2020 23:16	8,10	4	32,39	CHI
202012145451	ALTO PARAISO DE GOIAS	BF12302848	FLORES DE GOIAS	25/12/2020 15:10	25/12/2020 17:47	25/12/2020 15:10	25/12/2020 17:47	2,60	10	26,04	CHI
202012145503	GOIAS	GS12234111	GOIAS	25/12/2020 15:10	25/12/2020 17:15	25/12/2020 15:10	25/12/2020 17:15	2,08	51	106,05	CHI
202012146627	JATAI	JT121241676	JATAI S1	25/12/2020 15:13	26/12/2020 08:54	25/12/2020 15:13	26/12/2020 08:54	17,67	1	17,67	CHI
202012145461	FLORES DE GOIAS	FB12277951	IACIARA S2	25/12/2020 15:15	25/12/2020 17:48	25/12/2020 15:15	25/12/2020 17:48	2,55	5	12,73	CHI
202012145635	INHUMAS	IN12000127	INHUMAS S1	25/12/2020 15:16	25/12/2020 17:50	25/12/2020 15:16	25/12/2020 17:50	2,56	7	17,90	CHI
202012145477	CATALAO	GD12323404	CATALAO S1	25/12/2020 15:19	25/12/2020 17:15	25/12/2020 15:19	25/12/2020 17:15	1,93	3	5,79	CHI
202012146616	FAZENDA NOVA	FN12411313	BRITANIA	25/12/2020 15:20	26/12/2020 10:07	25/12/2020 15:20	26/12/2020 10:07	18,77	5	93,86	CHI
202012145531	FAZENDA NOVA	FN12259793	BRITANIA	25/12/2020 15:21	26/12/2020 08:41	25/12/2020 15:21	26/12/2020 08:41	17,33	13	225,33	CHI
202012145888	SANTO ANTONIO DA BARRA	BZ12303302	ACREUNA	25/12/2020 15:21	26/12/2020 11:00	25/12/2020 15:21	26/12/2020 11:00	19,65	12	235,84	CHI
202012145494	SANTA TEREZINHA DE GOIAS	SG11181030	SANTA TEREZINHA	25/12/2020 15:23	25/12/2020 16:55	25/12/2020 15:23	25/12/2020 16:41	1,31	160	209,11	CHI
202012145494	SANTA TEREZINHA DE GOIAS	SG12136335	SANTA TEREZINHA	25/12/2020 15:23	25/12/2020 16:55	25/12/2020 15:23	25/12/2020 16:55	1,53	44	67,17	CHI
202012145662	NIQUELANDIA	NQ12222646	URUACU	25/12/2020 15:26	25/12/2020 20:14	25/12/2020 15:26	25/12/2020 20:14	4,79	8	38,31	CHI
202012145511	AGUA FRIA DE GOIAS	JL12117446	SAO JOAO D ALIANCA	25/12/2020 15:29	25/12/2020 17:58	25/12/2020 15:29	25/12/2020 17:58	2,48	20	49,53	CHI
202012145511	SAO JOAO D ALIANCA	JL12117446	SAO JOAO D ALIANCA	25/12/2020 15:29	25/12/2020 17:58	25/12/2020 15:29	25/12/2020 17:58	2,48	26	64,39	CHI
202012145602	SILVANIA	AN12165598	DAIA S2	25/12/2020 15:30	25/12/2020 20:37	25/12/2020 15:30	25/12/2020 20:37	5,11	1	5,11	CHI
202012145602	GAMELEIRA DE GOIAS	AN12165598	DAIA S2	25/12/2020 15:30	25/12/2020 20:37	25/12/2020 15:30	25/12/2020 20:37	5,11	2	10,23	CHI
202012145699	PORANGATU	PO12262596	PORANGATU	25/12/2020 15:33	25/12/2020 19:02	25/12/2020 15:33	25/12/2020 19:02	3,48	38	132,23	CHI
202012145538	JUSSARA	JR21143091	BRITANIA	25/12/2020 15:37	26/12/2020 09:40	25/12/2020 15:37	26/12/2020 09:40	18,04	1	18,04	CHI
202012145796	SANTO ANTONIO DE GOIAS	GR12048879	NEROPOLIS S1	25/12/2020 15:40	25/12/2020 19:27	25/12/2020 15:40	25/12/2020 19:27	3,78	17	64,31	CHI
202012145547	MINEIROS	MY12071586	PARQUE DAS EMAS	25/12/2020 15:42	26/12/2020 09:06	25/12/2020 15:42	26/12/2020 09:06	17,38	3	52,15	CHI
202012146173	JATAI	JT12184205	JATAI S1	25/12/2020 15:43	25/12/2020 20:58	25/12/2020 15:43	25/12/2020 20:58	5,25	2	10,49	CHI
202012145560	MORRINHOS	MR12000343	MORRINHOS	25/12/2020 15:46	25/12/2020 21:29	25/12/2020 15:46	25/12/2020 21:29	5,72	4	22,88	CHI
202012145565	SANTO ANTONIO DO DESCOBERTO	SN21094548	MARAJOARA	25/12/2020 15:47	25/12/2020 20:24	25/12/2020 15:47	25/12/2020 20:24	4,61	1	4,61	CHI
202012145568	SAO JOAO DA PARAUNA	RP12259184	FIRMINOPOLIS S2	25/12/2020 15:48	25/12/2020 20:10	25/12/2020 15:48	25/12/2020 20:10	4,35	7	30,47	CHI
202012145568	PALMINOPOLIS	RP12259184	FIRMINOPOLIS S2	25/12/2020 15:48	25/12/2020 20:10	25/12/2020 15:48	25/12/2020 20:10	4,35	2	8,71	CHI
202012145578	GOIANIA	GN11040005	GOIANIA LESTE S1	25/12/2020 15:52	25/12/2020 20:15	25/12/2020 15:52	25/12/2020 20:15	4,37	83	363,12	CHI
202012145588	RIO VERDE	RV12379654	RIO VERDE S2	25/12/2020 15:55	25/12/2020 17:23	25/12/2020 15:55	25/12/2020 17:23	1,45	18	26,12	CHI
202012145611	INHUMAS	NV12272408	INHUMAS S1	25/12/2020 15:58	25/12/2020 20:33	25/12/2020 15:58	25/12/2020 20:33	4,58	19	87,08	CHI
202012145611	NOVA VENEZA	NV12272408	INHUMAS S1	25/12/2020 15:58	25/12/2020 20:33	25/12/2020 15:58	25/12/2020 20:33	4,58	9	41,25	CHI
202012145611	BRAZABRANTES	NV12272408	INHUMAS S1	25/12/2020 15:58	25/12/2020 20:33	25/12/2020 15:58	25/12/2020 20:33	4,58	60	274,98	CHI
202012145633	GAMELEIRA DE GOIAS	SV12026823	DAIA S2	25/12/2020 15:59	25/12/2020 22:14	25/12/2020 15:59	25/12/2020 22:14	6,24	8	49,89	CHI
202012146320	VIANOPOLIS	VN12033292	VIANOPOLIS	25/12/2020 15:59	25/12/2020 20:42	25/12/2020 15:59	25/12/2020 20:42	4,71	21	99,01	CHI
202012145614	PALESTINA DE GOIAS	PY12138375	PALESTINA	25/12/2020 16:04	26/12/2020 01:24	25/12/2020 16:04	26/12/2020 01:24	9,33	24	223,97	CHI

202012145622	CRIXAS	CX12322605	SERRA DO OURO	25/12/2020 16:05	25/12/2020 17:22	25/12/2020 16:05	25/12/2020 17:22	1,28	16	20,41	CHI
202012145657	HIDROLANDIA	HD12000269	CEPAIGO S1	25/12/2020 16:06	25/12/2020 19:17	25/12/2020 16:06	25/12/2020 19:17	3,17	121	383,84	CHI
202012145629	QUIRINOPOLIS	QI21191866	QUIRINOPOLIS	25/12/2020 16:07	25/12/2020 21:57	25/12/2020 16:07	25/12/2020 21:57	5,84	1	5,84	CHI
202012145644	SAO JOAO D ALIANCA	JL12383335	SAO JOAO D ALIANCA	25/12/2020 16:07	25/12/2020 17:38	25/12/2020 16:07	25/12/2020 17:38	1,51	11	16,59	CHI
202012145648	MINEIROS	MY12332634RE	PARQUE DAS EMAS	25/12/2020 16:11	27/12/2020 16:26	25/12/2020 16:11	27/12/2020 16:26	48,25	9	434,24	CHI
202012145655	IPORA	IR21139445	IPORA	25/12/2020 16:12	26/12/2020 00:42	25/12/2020 16:12	26/12/2020 00:42	8,50	1	8,50	CHI
202012145658	ORIZONA	OZ12073391	PIRES DO RIO S2	25/12/2020 16:12	25/12/2020 21:40	25/12/2020 16:12	25/12/2020 21:40	5,45	9	49,07	CHI
202012145703	CRIXAS	CX12318471	SERRA DO OURO	25/12/2020 16:12	25/12/2020 20:43	25/12/2020 16:12	25/12/2020 20:43	4,52	12	54,19	CHI
202012148024	MATRINCHA	MP12321180	MATRINCHA	25/12/2020 16:12	26/12/2020 10:30	25/12/2020 16:12	26/12/2020 10:30	18,29	9	164,59	CHI
202012145664	FORMOSA	FA21318478	ITUIQUIRA	25/12/2020 16:13	25/12/2020 18:23	25/12/2020 16:13	25/12/2020 18:23	2,16	2	4,33	CHI
202012145665	CACU	CC12000122LD	CACHOEIRA ALTA	25/12/2020 16:14	25/12/2020 17:35	25/12/2020 16:14	25/12/2020 17:35	1,35	10	13,51	CHI
202012145671	MORRINHOS	PJ12076912	MORRINHOS	25/12/2020 16:17	25/12/2020 20:25	25/12/2020 16:17	25/12/2020 20:25	4,12	4	16,47	CHI
202012145742	PALMEIRAS DE GOIAS	PL12308411	PALMEIRAS	25/12/2020 16:20	26/12/2020 11:09	25/12/2020 16:20	26/12/2020 10:44	18,39	8	147,15	CHI
202012145742	PALMEIRAS DE GOIAS	PL12090322LD	PALMEIRAS	25/12/2020 16:20	26/12/2020 11:09	25/12/2020 16:20	26/12/2020 11:09	18,81	165	3104,20	CHI
202012145738	GOIANIA	GN12269050	CARAJAS S2	25/12/2020 16:23	25/12/2020 21:00	25/12/2020 16:23	25/12/2020 17:58	1,57	308	485,01	CHI
202012145738	GOIANIA	GN11274972	CARAJAS S2	25/12/2020 16:23	25/12/2020 21:00	25/12/2020 16:23	25/12/2020 17:59	1,59	58	92,28	CHI
202012145738	GOIANIA	GN11274972	CARAJAS S2	25/12/2020 16:23	25/12/2020 21:00	25/12/2020 19:33	25/12/2020 21:00	1,44	58	83,76	CHI
202012145685	QUIRINOPOLIS	QI21064758	QUIRINOPOLIS	25/12/2020 16:24	25/12/2020 20:28	25/12/2020 16:24	25/12/2020 20:28	4,07	1	4,07	CHI
202012145702	PIRACANJUBA	PJ12223255	ROCHEDO	25/12/2020 16:24	25/12/2020 20:28	25/12/2020 16:24	25/12/2020 20:28	4,05	22	89,14	CHI
202012145695	MINEIROS	MY21216691	PARQUE DAS EMAS	25/12/2020 16:26	26/12/2020 10:50	25/12/2020 16:26	26/12/2020 10:50	18,39	1	18,39	CHI
202012145704	QUIRINOPOLIS	QI21306072	QUIRINOPOLIS	25/12/2020 16:29	25/12/2020 23:45	25/12/2020 16:29	25/12/2020 23:45	7,27	1	7,27	CHI
202012145721	SAO DOMINGOS	SD12269338	SAO DOMINGOS	25/12/2020 16:31	25/12/2020 19:12	25/12/2020 16:31	25/12/2020 19:12	2,67	5	13,36	CHI
202012145721	GUARANI DE GOIAS	SD12269338	SAO DOMINGOS	25/12/2020 16:31	25/12/2020 19:12	25/12/2020 16:31	25/12/2020 19:12	2,67	3	8,01	CHI
202012145837	CACHOEIRA DOURADA	CD12222447	CACHOEIRA DOURADA	25/12/2020 16:31	25/12/2020 19:48	25/12/2020 16:31	25/12/2020 19:48	3,28	1	3,28	CHI
202012145728	GOIATUBA	GT12043160	GOIATUBA S1	25/12/2020 16:33	26/12/2020 10:43	25/12/2020 16:33	26/12/2020 10:04	17,53	1	17,53	CHI
202012145728	ITUMBUIARA	GT12263930	GOIATUBA S1	25/12/2020 16:33	26/12/2020 10:43	26/12/2020 07:48	26/12/2020 10:43	2,92	1	2,92	CHI
202012145728	GOIATUBA	GT12263930	GOIATUBA S1	25/12/2020 16:33	26/12/2020 10:43	26/12/2020 07:48	26/12/2020 10:43	2,92	33	96,49	CHI
202012145728	BURITI ALEGRE	GT12263930	GOIATUBA S1	25/12/2020 16:33	26/12/2020 10:43	26/12/2020 07:48	26/12/2020 10:43	2,92	2	5,85	CHI
202012145743	CRIXAS	CX12276585	SERRA DO OURO	25/12/2020 16:35	26/12/2020 01:05	25/12/2020 16:35	26/12/2020 01:05	8,49	2	16,99	CHI
202012145749	DOVERLANDIA	DV12087027	CAIAPONIA	25/12/2020 16:36	26/12/2020 17:17	25/12/2020 16:36	26/12/2020 17:17	24,68	2	49,36	CHI
202012145755	JOVIANIA	JV12381188	GOIATUBA S1	25/12/2020 16:38	25/12/2020 21:36	25/12/2020 16:38	25/12/2020 21:36	4,96	4	19,85	CHI
202012145757	PANAMA	GT12000140	GOIATUBA S1	25/12/2020 16:38	26/12/2020 01:28	25/12/2020 16:38	26/12/2020 01:28	8,83	4	35,30	CHI
202012145762	ITABERAI	IB12108138	ITABERAI S2	25/12/2020 16:38	25/12/2020 21:28	25/12/2020 16:38	25/12/2020 21:28	4,83	29	140,02	CHI
202012145765	GOIANIA	GN12158321	GOIANIA LESTE S2	25/12/2020 16:40	25/12/2020 17:00	25/12/2020 16:40	25/12/2020 17:00	0,32	114	36,95	CHI
202012145773	GOIANESIA	GE12221555	GOIANESIA S2	25/12/2020 16:42	25/12/2020 19:02	25/12/2020 16:42	25/12/2020 18:40	1,95	638	1246,05	CHI
202012145773	GOIANESIA	GE11339378	GOIANESIA S2	25/12/2020 16:42	25/12/2020 19:02	25/12/2020 16:42	25/12/2020 19:02	2,33	120	279,07	CHI
202012145778	MORRINHOS	MR12128674	MORRINHOS	25/12/2020 16:44	26/12/2020 09:48	25/12/2020 16:44	26/12/2020 09:48	17,07	19	324,34	CHI
202012145785	QUIRINOPOLIS	QI12296614LD	QUIRINOPOLIS	25/12/2020 16:46	26/12/2020 13:50	25/12/2020 16:46	26/12/2020 13:50	21,06	11	231,69	CHI
202012145785	CASTELANDIA	QI12296614LD	QUIRINOPOLIS	25/12/2020 16:46	26/12/2020 13:50	25/12/2020 16:46	26/12/2020 13:50	21,06	1	21,06	CHI
202012145795	MORRINHOS	MR12000140	MORRINHOS	25/12/2020 16:48	25/12/2020 17:53	25/12/2020 16:48	25/12/2020 17:53	1,07	4	4,30	CHI
202012145800	PARAUNA	PU12348598	PARAUNA	25/12/2020 16:50	25/12/2020 20:44	25/12/2020 16:50	25/12/2020 20:44	3,91	2	7,82	CHI
202012145951	CORUMBA DE GOIAS	CB12295651	ALEXANIA	25/12/2020 16:52	25/12/2020 20:33	25/12/2020 16:52	25/12/2020 20:33	3,68	10	36,78	CHI
202012145951	ALEXANIA	CB12295651	ALEXANIA	25/12/2020 16:52	25/12/2020 20:33	25/12/2020 16:52	25/12/2020 20:33	3,68	2	7,36	CHI
202012145855	VILA PROPICIO	NP12298225	BARRO ALTO	25/12/2020 16:53	26/12/2020 02:53	25/12/2020 16:53	26/12/2020 02:53	9,99	15	149,90	CHI
202012145884	FAZENDA NOVA	JR12362437	BRITANIA	25/12/2020 16:54	25/12/2020 23:01	25/12/2020 16:54	25/12/2020 23:01	6,10	3	18,31	CHI
202012145884	JUSSARA	JR12362437	BRITANIA	25/12/2020 16:54	25/12/2020 23:01	25/12/2020 16:54	25/12/2020 23:01	6,10	7	42,73	CHI
202012145890	FLORES DE GOIAS	FB12277896	IACIARA S2	25/12/2020 16:55	25/12/2020 18:38	25/12/2020 16:55	25/12/2020 18:38	1,70	3	5,11	CHI
202012145890	SITIO D ABADIA	FB12277896	IACIARA S2	25/12/2020 16:55	25/12/2020 18:38	25/12/2020 16:55	25/12/2020 18:38	1,70	20	34,07	CHI
202012145910	URUTAI	UT12027112RE	PIRES DO RIO S2	25/12/2020 16:55	25/12/2020 18:46	25/12/2020 16:55	25/12/2020 18:46	1,84	20	36,71	CHI
202012179441	JARAGUA	JA21297958	JARAGUA	25/12/2020 16:55	27/12/2020 02:02	25/12/2020 16:55	27/12/2020 02:02	33,12	1	33,12	CHI
202012145825	INHUMAS	IN11012261	INHUMAS S2	25/12/2020 16:56	25/12/2020 23:34	25/12/2020 16:56	25/12/2020 23:34	6,63	63	417,90	CHI

202012145826	ORIZONA	OZ11000061	PIRES DO RIO S2	25/12/2020 16:56	25/12/2020 20:04	25/12/2020 16:56	25/12/2020 20:04	3,13	68	212,97	CHI
202012145867	MAURILANDIA	CL12306027	RIO DOS BOIS	25/12/2020 16:56	25/12/2020 18:28	25/12/2020 16:56	25/12/2020 18:28	1,52	2	3,05	CHI
202012145867	PORTEIRAO	CL12306027	RIO DOS BOIS	25/12/2020 16:56	25/12/2020 18:28	25/12/2020 16:56	25/12/2020 18:28	1,52	1	1,52	CHI
202012145715	HIDROLANDIA	180005091	INDEPENDENCIA S1	25/12/2020 16:58	26/12/2020 03:02	25/12/2020 16:58	26/12/2020 03:02	10,07	1	10,07	CHI
202012145833	NEROPOLIS	NR32085142	NEROPOLIS S1	25/12/2020 16:58	26/12/2020 01:30	25/12/2020 16:58	26/12/2020 01:30	8,54	2	17,07	CHI
202012145838	ABADIANIA	AA21180473	CORUMBA	25/12/2020 16:59	25/12/2020 18:56	25/12/2020 16:59	25/12/2020 18:56	1,96	1	1,96	CHI
202012145841	GOIATUBA	GT12197911	GOIATUBA S2	25/12/2020 17:00	25/12/2020 21:58	25/12/2020 17:00	25/12/2020 21:58	4,95	1	4,95	CHI
202012145842	LUZIANIA	LZ12237925	MARAJOARA	25/12/2020 17:01	25/12/2020 18:23	25/12/2020 17:01	25/12/2020 18:23	1,36	44	59,96	CHI
202012145885	GOIANIA	GN12000819	FERROVIARIO S1	25/12/2020 17:02	25/12/2020 18:13	25/12/2020 17:02	25/12/2020 18:13	1,18	1313	1553,35	CHI
202012145852	CATALAO	CT12000054	CATALAO S1	25/12/2020 17:04	25/12/2020 18:06	25/12/2020 17:04	25/12/2020 18:06	1,02	2	2,05	CHI
202012145852	OUVIDOR	CT12000054	CATALAO S1	25/12/2020 17:04	25/12/2020 18:06	25/12/2020 17:04	25/12/2020 18:06	1,02	1	1,02	CHI
202012146451	VIANOPOLIS	OZ12094957	VIANOPOLIS	25/12/2020 17:05	25/12/2020 22:28	25/12/2020 17:05	25/12/2020 22:28	5,37	34	182,52	CHI
202012145863	COCALZINHO DE GOIAS	19802340	COCALZINHO	25/12/2020 17:06	26/12/2020 10:19	25/12/2020 17:06	26/12/2020 10:19	17,20	2	34,40	CHI
202012145872	PIRES DO RIO	PR12265575	PIRES DO RIO S1	25/12/2020 17:09	25/12/2020 19:26	25/12/2020 17:09	25/12/2020 19:26	2,28	2	4,57	CHI
202012145875	JATAI	JT12182021	JATAI S1	25/12/2020 17:09	25/12/2020 20:49	25/12/2020 17:09	25/12/2020 20:49	3,65	1	3,65	CHI
202012145893	LUZIANIA	SV12249236	VIANOPOLIS	25/12/2020 17:14	26/12/2020 00:10	25/12/2020 17:14	26/12/2020 00:10	6,92	2	13,85	CHI
202012145898	PIRACANJUBA	PJ10394717	PIRACANJUBA	25/12/2020 17:15	25/12/2020 19:35	25/12/2020 19:31	25/12/2020 19:35	0,06	172	10,37	CHI
202012146148	NAZARIO	NZ12003900	ANICUNS	25/12/2020 17:16	25/12/2020 23:48	25/12/2020 17:16	25/12/2020 23:48	6,52	12	78,24	CHI
202012145905	NOVA CRIXAS	NA12090020	NOVA CRIXAS	25/12/2020 17:17	25/12/2020 20:47	25/12/2020 17:17	25/12/2020 20:47	3,50	11	38,50	CHI
202012145907	MONTES CLAROS DE GOIAS	ME12050933	IPORA	25/12/2020 17:17	26/12/2020 08:54	25/12/2020 17:17	26/12/2020 08:54	15,62	7	109,31	CHI
202012145912	LEOPOLDO DE BULHOES	6847829	VIANOPOLIS	25/12/2020 17:18	26/12/2020 08:55	25/12/2020 17:18	26/12/2020 08:55	15,60	1	15,60	CHI
202012145917	NOVO BRASIL	NB21376359	JUSSARA	25/12/2020 17:19	26/12/2020 09:15	25/12/2020 17:19	26/12/2020 09:15	15,92	1	15,92	CHI
202012146157	ORIZONA	OZ12404726	PIRES DO RIO S1	25/12/2020 17:19	25/12/2020 22:17	25/12/2020 17:19	25/12/2020 22:17	4,97	9	44,69	CHI
202012145923	HIDROLANDIA	HD12024197	CEPAIGO S2	25/12/2020 17:20	25/12/2020 22:18	25/12/2020 17:20	25/12/2020 22:18	4,95	2	9,91	CHI
202012145894	GUARANI DE GOIAS	GY13067850	IACIARA S1	25/12/2020 17:22	26/12/2020 00:05	25/12/2020 17:22	26/12/2020 00:05	6,71	517	3470,51	CHI
202012145894	IACIARA	GY13067850	IACIARA S1	25/12/2020 17:22	26/12/2020 00:05	25/12/2020 17:22	26/12/2020 00:05	6,71	2	13,43	CHI
202012145894	GUARANI DE GOIAS	GY13067850	IACIARA S1	25/12/2020 17:22	26/12/2020 00:05	25/12/2020 21:50	26/12/2020 00:05	2,25	339	762,56	CHI
202012145933	ARENOPOLIS	AY12139436	ARENOPOLIS	25/12/2020 17:22	25/12/2020 19:11	25/12/2020 17:22	25/12/2020 19:11	1,80	16	28,84	CHI
202012145933	IPORA	AY12139436	ARENOPOLIS	25/12/2020 17:22	25/12/2020 19:11	25/12/2020 17:22	25/12/2020 19:11	1,80	10	18,03	CHI
202012146150	SANTO ANTONIO DA BARRA	BZ12301386	ACREUNA	25/12/2020 17:22	25/12/2020 21:28	25/12/2020 17:22	25/12/2020 21:28	4,10	2	8,19	CHI
202012145941	PONTALINA	PK21041764	PONTALINA	25/12/2020 17:24	25/12/2020 23:00	25/12/2020 17:24	25/12/2020 23:00	5,59	1	5,59	CHI
202012146868	GOIANIRA	GR12272374LD	MEIA PONTE	25/12/2020 17:25	26/12/2020 00:39	25/12/2020 17:25	26/12/2020 00:39	7,23	6	43,36	CHI
202012145968	LUZIANIA	LZ12230126	MARAJOARA	25/12/2020 17:30	25/12/2020 19:28	25/12/2020 17:30	25/12/2020 19:28	1,96	163	318,67	CHI
202012146100	SILVANIA	LB12267902	DAIA S2	25/12/2020 17:34	26/12/2020 14:09	25/12/2020 17:34	26/12/2020 09:05	15,51	83	1287,65	CHI
202012146100	LEOPOLDO DE BULHOES	LB12267902	DAIA S2	25/12/2020 17:34	26/12/2020 14:09	25/12/2020 17:34	26/12/2020 14:09	20,59	1	20,59	CHI
202012146100	SILVANIA	LB12267902	DAIA S2	25/12/2020 17:34	26/12/2020 14:09	25/12/2020 17:34	26/12/2020 14:09	20,59	33	679,33	CHI
202012146100	SILVANIA	LB12267902	DAIA S2	25/12/2020 17:34	26/12/2020 14:09	26/12/2020 09:08	26/12/2020 14:09	5,02	83	416,96	CHI
202012146002	TRINDADE	7592817	INHUMAS S1	25/12/2020 17:35	26/12/2020 17:31	25/12/2020 17:35	26/12/2020 17:31	23,94	1	23,94	CHI
202012146369	LUZIANIA	LZ12370746	RIO VERMELHO	25/12/2020 17:35	26/12/2020 00:00	25/12/2020 17:35	26/12/2020 00:00	6,40	53	339,23	CHI
202012146025	LUZIANIA	LZ12396836	MARAJOARA	25/12/2020 17:36	25/12/2020 21:07	25/12/2020 17:36	25/12/2020 21:07	3,52	13	45,80	CHI
202012145998	AGUAS LINDAS DE GOIAS	LA11136557	AGUAS LINDAS DE GOIAS S1	25/12/2020 17:37	25/12/2020 19:51	25/12/2020 17:37	25/12/2020 19:51	2,23	180	402,05	CHI
202012146313	AVELINOPOLIS	AV12282415	ANICUNS	25/12/2020 17:38	25/12/2020 22:14	25/12/2020 17:38	25/12/2020 22:14	4,58	4	18,34	CHI
202012146313	ANICUNS	AV12282415	ANICUNS	25/12/2020 17:38	25/12/2020 22:14	25/12/2020 17:38	25/12/2020 22:14	4,58	48	220,05	CHI
202012146010	MINEIROS	1390108330	PARQUE DAS EMAS	25/12/2020 17:39	26/12/2020 08:10	25/12/2020 17:39	26/12/2020 08:10	14,52	1	14,52	CHI
202012146237	SAO MIGUEL DO ARAGUAIA	SM12245801	SAO MIGUEL DO ARAGUAIA	25/12/2020 17:40	25/12/2020 20:05	25/12/2020 17:40	25/12/2020 20:05	2,41	3	7,24	CHI
202012146448	FLORES DE GOIAS	FA12397042LD	ITUIQUIRA	25/12/2020 17:40	26/12/2020 01:38	25/12/2020 17:40	26/12/2020 01:38	7,97	1	7,97	CHI
202012146448	FORMOSA	FA12397042LD	ITUIQUIRA	25/12/2020 17:40	26/12/2020 01:38	25/12/2020 17:40	26/12/2020 01:38	7,97	38	302,79	CHI
202012146042	ARAGARCAS	AG12334918	ARAGARCAS	25/12/2020 17:42	26/12/2020 16:28	25/12/2020 17:42	26/12/2020 16:28	22,76	3	68,29	CHI
202012146031	MATRINCHA	MP12250742	MATRINCHA	25/12/2020 17:45	26/12/2020 11:20	25/12/2020 17:45	26/12/2020 11:20	17,58	1	17,58	CHI
202012146191	LUZIANIA	OZ12195112	PIRES DO RIO S2	25/12/2020 17:45	25/12/2020 20:40	25/12/2020 17:45	25/12/2020 20:40	2,90	74	214,62	CHI
202012146037	CATALAO	CT12215512	CATALAO S1	25/12/2020 17:46	25/12/2020 19:35	25/12/2020 17:46	25/12/2020 19:35	1,81	1	1,81	CHI

202012146052	APARECIDA DO RIO DOCE	AW12291508	CACHOEIRA ALTA	25/12/2020 17:47	25/12/2020 19:44	25/12/2020 17:47	25/12/2020 19:44	1,93	1	1,93	CHI
202012146062	BELA VISTA DE GOIAS	BV11156610	BELA VISTA S2	25/12/2020 17:50	25/12/2020 23:23	25/12/2020 17:55	25/12/2020 23:23	5,47	121	662,21	CHI
202012146071	CAVALCANTE	CJ12346073	MINACU	25/12/2020 17:52	26/12/2020 10:47	25/12/2020 17:52	26/12/2020 10:47	16,91	147	2485,16	CHI
202012146075	BELA VISTA DE GOIAS	BV21229442	BELA VISTA S2	25/12/2020 17:52	26/12/2020 21:18	25/12/2020 17:52	25/12/2020 23:01	5,16	1	5,16	CHI
202012146075	BELA VISTA DE GOIAS	BV12229444LD	BELA VISTA S2	25/12/2020 17:52	26/12/2020 21:18	26/12/2020 18:09	26/12/2020 21:18	3,15	40	126,13	CHI
202012146151	LUZIANIA	LZ16410102	RIO VERMELHO	25/12/2020 17:52	26/12/2020 15:43	25/12/2020 19:02	25/12/2020 19:06	0,06	1094	61,08	CHI
202012146151	LUZIANIA	LZ10396081	RIO VERMELHO	25/12/2020 17:52	26/12/2020 15:43	25/12/2020 19:02	25/12/2020 19:08	0,09	866	76,98	CHI
202012146151	LUZIANIA	04210244	RIO VERMELHO	25/12/2020 17:52	26/12/2020 15:43	25/12/2020 19:00	25/12/2020 19:36	0,60	1002	598,97	CHI
202012146151	LUZIANIA	04210284	RIO VERMELHO	25/12/2020 17:52	26/12/2020 15:43	25/12/2020 19:00	25/12/2020 19:36	0,61	334	203,09	CHI
202012146151	LUZIANIA	LZ10396081	RIO VERMELHO	25/12/2020 17:52	26/12/2020 15:43	25/12/2020 19:09	25/12/2020 19:39	0,49	866	423,62	CHI
202012146151	LUZIANIA	LZ11199532	RIO VERMELHO	25/12/2020 17:52	26/12/2020 15:43	25/12/2020 19:00	25/12/2020 22:27	3,44	176	606,22	CHI
202012146151	LUZIANIA	LZ11000112	RIO VERMELHO	25/12/2020 17:52	26/12/2020 15:43	25/12/2020 19:11	25/12/2020 23:15	4,07	125	508,33	CHI
202012146151	LUZIANIA	00060424	MARAJOARA	25/12/2020 17:52	26/12/2020 15:43	25/12/2020 17:52	25/12/2020 23:39	5,79	12	69,45	CHI
202012146151	LUZIANIA	00060424	MARAJOARA	25/12/2020 17:52	26/12/2020 15:43	25/12/2020 17:52	26/12/2020 15:43	21,84	1	21,84	CHI
202012146151	LUZIANIA	00060424	MARAJOARA	25/12/2020 17:52	26/12/2020 15:43	26/12/2020 15:20	26/12/2020 15:43	0,37	12	4,47	CHI
202012146081	PALMEIRAS DE GOIAS	PL12100447	PALMEIRAS	25/12/2020 17:54	25/12/2020 20:15	25/12/2020 17:54	25/12/2020 20:15	2,34	5	11,71	CHI
202012146086	ABADIANIA	AA12146399	ANAPOLIS UNIVERSITARIO S1	25/12/2020 17:54	25/12/2020 20:34	25/12/2020 17:54	25/12/2020 20:34	2,65	14	37,11	CHI
202012146086	GAMELEIRA DE GOIAS	AA12146399	ANAPOLIS UNIVERSITARIO S1	25/12/2020 17:54	25/12/2020 20:34	25/12/2020 17:54	25/12/2020 20:34	2,65	2	5,30	CHI
202012146095	CACU	CC12191701	CACHOEIRA ALTA	25/12/2020 17:56	25/12/2020 19:49	25/12/2020 17:56	25/12/2020 19:49	1,88	86	161,44	CHI
202012146098	PORANGATU	PO12391930	PORANGATU	25/12/2020 17:56	26/12/2020 03:08	25/12/2020 17:56	26/12/2020 03:08	9,19	58	533,10	CHI
202012146353	GOIAS	GS12206884	GOIAS	25/12/2020 17:56	25/12/2020 23:13	25/12/2020 17:56	25/12/2020 23:13	5,29	16	84,57	CHI
202012146113	ARAGARCAS	AG11052637	ARAGARCAS	25/12/2020 17:59	25/12/2020 22:30	25/12/2020 17:59	25/12/2020 22:30	4,53	90	407,43	CHI
202012146344	LEOPOLDO DE BULHOES	LB12302184	DAIA S2	25/12/2020 18:01	25/12/2020 21:17	25/12/2020 18:01	25/12/2020 21:17	3,25	8	26,03	CHI
202012146155	IACIARA	IA12195754	IACIARA S1	25/12/2020 18:04	25/12/2020 19:36	25/12/2020 18:04	25/12/2020 19:36	1,53	2	3,05	CHI
202012146165	JANDAIA	7307380	PALMEIRAS	25/12/2020 18:07	26/12/2020 07:14	25/12/2020 18:07	26/12/2020 07:14	13,11	14	183,53	CHI
202012146630	JATAI	JT12182190	JATAI S1	25/12/2020 18:08	26/12/2020 08:54	25/12/2020 18:08	26/12/2020 08:54	14,75	5	73,75	CHI
202012146232	EDEIA	EA12044037	EDEIA	25/12/2020 18:09	25/12/2020 20:32	25/12/2020 18:09	25/12/2020 20:32	2,37	37	87,62	CHI
202012146595	CAIAPONIA	CP12207858	PALESTINA	25/12/2020 18:12	26/12/2020 14:42	25/12/2020 18:12	26/12/2020 14:42	20,48	22	450,65	CHI
202012146595	PALESTINA DE GOIAS	CP12207858	PALESTINA	25/12/2020 18:12	26/12/2020 14:42	25/12/2020 18:12	26/12/2020 14:42	20,48	1	20,48	CHI
202012146186	MONTE ALEGRE DE GOIAS	MA12129814	SAO DOMINGOS	25/12/2020 18:13	25/12/2020 19:33	25/12/2020 18:13	25/12/2020 19:33	1,33	31	41,17	CHI
202012146187	PORTEIRAO	CL12301100LD	RIO DOS BOIS	25/12/2020 18:13	25/12/2020 21:12	25/12/2020 18:13	25/12/2020 21:12	2,98	5	14,88	CHI
202012146211	SAO JOAO D ALIANCA	JL12106845	SAO JOAO D ALIANCA	25/12/2020 18:14	25/12/2020 19:42	25/12/2020 18:14	25/12/2020 19:42	1,46	15	21,97	CHI
202012146496	LUZIANIA	LZ12353712	VIANOPOLIS	25/12/2020 18:21	25/12/2020 21:57	25/12/2020 18:21	25/12/2020 21:57	3,60	29	104,31	CHI
202012146231	CIDADE OCIDENTAL	DH12261785	MARAJOARA	25/12/2020 18:24	25/12/2020 21:42	25/12/2020 18:24	25/12/2020 21:42	3,29	32	105,38	CHI
202012147203	ARAGOIANIA	HD12000067	INDEPENDENCIA S1	25/12/2020 18:26	26/12/2020 15:09	25/12/2020 18:26	26/12/2020 15:09	20,71	5	103,57	CHI
202012147203	HIDROLANDIA	HD12000067	INDEPENDENCIA S1	25/12/2020 18:26	26/12/2020 15:09	25/12/2020 18:26	26/12/2020 15:09	20,71	11	227,86	CHI
202012146248	AURILANDIA	6625084	FIRMINOPOLIS S2	25/12/2020 18:28	25/12/2020 21:23	25/12/2020 18:28	25/12/2020 21:23	2,92	1	2,92	CHI
202012146250	NOVA IGUACU DE GOIAS	NH12245483	SANTA TEREZINHA	25/12/2020 18:28	25/12/2020 21:05	25/12/2020 18:28	25/12/2020 21:05	2,60	3	7,81	CHI
202012146263	GOIATUBA	GT12044818	GOIATUBA S2	25/12/2020 18:31	25/12/2020 22:42	25/12/2020 18:31	25/12/2020 22:42	4,17	6	25,02	CHI
202012146799	SANTO ANTONIO DA BARRA	BZ21191564	ACREUNA	25/12/2020 18:32	25/12/2020 23:00	25/12/2020 18:32	25/12/2020 23:00	4,48	1	4,48	CHI
202012146277	IPORA	IR12374853	IPORA	25/12/2020 18:34	26/12/2020 09:36	25/12/2020 18:34	26/12/2020 09:36	15,03	2	30,06	CHI
202012146669	MUTUNOPOLIS	MU12263034	MARA ROSA	25/12/2020 18:41	26/12/2020 00:05	25/12/2020 18:41	26/12/2020 00:05	5,39	3	16,16	CHI
202012146372	QUIRINOPOLIS	QI12226698	SANTA HELENA S1	25/12/2020 18:43	25/12/2020 21:02	25/12/2020 18:43	25/12/2020 21:02	2,30	6	13,83	CHI
202012146335	PLANALTINA	PI12085567	PLANALTINA	25/12/2020 18:44	25/12/2020 19:50	25/12/2020 18:44	25/12/2020 19:50	1,09	5	5,45	CHI
202012145973	ALTO HORIZONTE	AJ12374752	SANTA TEREZINHA	25/12/2020 18:45	26/12/2020 03:11	25/12/2020 18:45	26/12/2020 03:11	8,43	3	25,30	CHI
202012146345	ARUANA	AK12250809	ARUANA	25/12/2020 18:47	26/12/2020 08:26	25/12/2020 18:47	26/12/2020 08:26	13,65	2	27,30	CHI
202012146346	GOIANIA	GN21044157	GOYA S1	25/12/2020 18:47	26/12/2020 07:44	26/12/2020 18:47	26/12/2020 07:44	12,95	1	12,95	CHI
202012146351	CRIXAS	CX12281130	SERRA DO OURO	25/12/2020 18:48	25/12/2020 23:28	25/12/2020 18:48	25/12/2020 23:28	4,67	2	9,33	CHI
202012146354	BELA VISTA DE GOIAS	BV12009000	BELA VISTA S2	25/12/2020 18:48	25/12/2020 20:29	25/12/2020 18:48	25/12/2020 20:29	1,67	56	93,71	CHI
202012146602	LUZIANIA	LZ10410943	CRISTALINA S2	25/12/2020 18:49	26/12/2020 15:31	25/12/2020 18:49	26/12/2020 15:31	20,71	27	559,21	CHI
202012146602	LUZIANIA	LZ10410943	CRISTALINA S2	25/12/2020 18:49	26/12/2020 15:31	25/12/2020 21:51	26/12/2020 15:31	17,68	40	707,07	CHI

202012146360	MIMOSO DE GOIAS	MJ12183873	PADRE BERNARDO	25/12/2020 18:50	25/12/2020 20:25	25/12/2020 18:50	25/12/2020 20:25	1,58	8	12,63	CHI
202012146376	PORANGATU	PO12265863	NOVO PLANALTO	25/12/2020 18:54	26/12/2020 08:54	25/12/2020 18:54	26/12/2020 08:54	13,99	1	13,99	CHI
202012147072	ALVORADA DO NORTE	AQ12257628	FLORES DE GOIAS	25/12/2020 18:55	26/12/2020 02:07	25/12/2020 18:55	26/12/2020 02:07	7,20	10	71,98	CHI
202012147072	POSSE	AQ12257628	FLORES DE GOIAS	25/12/2020 18:55	26/12/2020 02:07	25/12/2020 18:55	26/12/2020 02:07	7,20	1	7,20	CHI
202012146396	MINEIROS	1390142362	PARQUE DAS EMAS	25/12/2020 18:58	26/12/2020 09:11	25/12/2020 18:58	26/12/2020 09:11	14,22	1	14,22	CHI
202012146404	IPAMERI	KR12163076	CRISTALINA S2	25/12/2020 18:59	25/12/2020 21:48	25/12/2020 18:59	25/12/2020 21:48	2,80	10	28,00	CHI
202012146507	POSSE	PS12235222	IACIARA S2	25/12/2020 18:59	25/12/2020 20:47	25/12/2020 18:59	25/12/2020 20:47	1,78	149	265,88	CHI
202012146420	MORRINHOS	MR12016157	GOIATUBA S2	25/12/2020 19:03	25/12/2020 20:43	25/12/2020 19:03	25/12/2020 20:43	1,66	1	1,66	CHI
202012146583	LUZIANIA	LZ12137225	VIANOPOLIS	25/12/2020 19:04	25/12/2020 22:51	25/12/2020 19:04	25/12/2020 22:51	3,78	13	49,18	CHI
202012146462	MINEIROS	MY12324492	PARQUE DAS EMAS	25/12/2020 19:11	26/12/2020 05:07	25/12/2020 19:11	26/12/2020 05:07	9,94	1	9,94	CHI
202012146647	VARJAO	GA12266688	GUAPO S2	25/12/2020 19:12	25/12/2020 22:45	25/12/2020 19:12	25/12/2020 22:45	3,55	10	35,46	CHI
202012146647	GUAPO	GA12266688	GUAPO S2	25/12/2020 19:12	25/12/2020 22:45	25/12/2020 19:12	25/12/2020 22:45	3,55	22	78,01	CHI
202012146647	ARAGOIANIA	GA12266688	GUAPO S2	25/12/2020 19:12	25/12/2020 22:45	25/12/2020 19:12	25/12/2020 22:45	3,55	1	3,55	CHI
202012146489	LEOPOLDO DE BULHOES	BO12400465	CEPAIGO S2	25/12/2020 19:14	26/12/2020 19:59	25/12/2020 19:14	26/12/2020 19:59	24,74	12	296,83	CHI
202012146489	BONFINOPOLIS	BO12400465	CEPAIGO S2	25/12/2020 19:14	26/12/2020 19:59	25/12/2020 19:14	26/12/2020 19:59	24,74	3	74,21	CHI
202012146513	GOIANIRA	GR10396914	GOIANIRA	25/12/2020 19:14	26/12/2020 01:02	25/12/2020 19:14	25/12/2020 19:18	0,06	865	54,78	CHI
202012146513	TRINDADE	GR10396914	GOIANIRA	25/12/2020 19:14	26/12/2020 01:02	25/12/2020 19:14	25/12/2020 19:18	0,06	2	0,13	CHI
202012146513	GOIANIRA	GR10396914	GOIANIRA	25/12/2020 19:14	26/12/2020 01:02	25/12/2020 19:14	26/12/2020 01:02	5,80	1338	7762,26	CHI
202012146513	TRINDADE	GR10396914	GOIANIRA	25/12/2020 19:14	26/12/2020 01:02	25/12/2020 19:14	26/12/2020 01:02	5,80	1	5,80	CHI
202012146536	AVELINOPOLIS	AV12020485	ANICUNS	25/12/2020 19:15	26/12/2020 11:10	25/12/2020 19:15	25/12/2020 23:40	4,41	25	110,22	CHI
202012146536	AVELINOPOLIS	AV12020485	ANICUNS	25/12/2020 19:15	26/12/2020 11:10	25/12/2020 23:45	26/12/2020 10:09	10,41	15	156,08	CHI
202012146536	AVELINOPOLIS	AV12020485	ANICUNS	25/12/2020 19:15	26/12/2020 11:10	26/12/2020 10:26	26/12/2020 10:54	0,46	15	6,90	CHI
202012146536	AVELINOPOLIS	AV12323539LD	ANICUNS	25/12/2020 19:15	26/12/2020 11:10	25/12/2020 23:45	26/12/2020 11:10	11,43	10	114,29	CHI
202012146512	BRITANIA	BT21101442	BRITANIA	25/12/2020 19:18	26/12/2020 02:42	25/12/2020 19:18	26/12/2020 02:42	7,39	1	7,39	CHI
202012146516	NOVO GAMA	NU11276292	PACAEMBU S2	25/12/2020 19:19	25/12/2020 23:06	25/12/2020 19:19	25/12/2020 23:06	3,78	2	7,57	CHI
202012146517	GOIATUBA	GT12000212	BOM JESUS DE GOIAS	25/12/2020 19:19	25/12/2020 23:02	25/12/2020 19:19	25/12/2020 23:02	3,71	5	18,56	CHI
202012146575	ANAPOLIS	AN12351005	ANAPOLIS UNIVERSITARIO S2	25/12/2020 19:20	25/12/2020 21:30	25/12/2020 19:20	25/12/2020 21:30	2,15	281	604,70	CHI
202012146534	BOM JARDIM DE GOIAS	BM21335393	BOM JARDIM	25/12/2020 19:22	25/12/2020 22:12	25/12/2020 19:22	25/12/2020 22:12	2,83	1	2,83	CHI
202012146544	PORANGATU	PO12320954	NOVO PLANALTO	25/12/2020 19:24	25/12/2020 21:23	25/12/2020 19:24	25/12/2020 21:23	1,98	13	25,71	CHI
202012146556	RIO VERDE	RV12260596	CABRIUVA S2	25/12/2020 19:25	25/12/2020 21:20	25/12/2020 19:25	25/12/2020 21:20	1,90	2	3,80	CHI
202012147184	PORANGATU	PO12391648	NOVO PLANALTO	25/12/2020 19:28	26/12/2020 21:29	25/12/2020 19:28	26/12/2020 21:29	26,02	4	104,08	CHI
202012146600	CRISTALINA	KR11320139	CRISTALINA S1	25/12/2020 19:36	26/12/2020 20:32	25/12/2020 19:36	25/12/2020 20:32	0,92	136	125,01	CHI
202012146772	IPORA	AY12139436	ARENOPOLIS	25/12/2020 19:36	26/12/2020 10:05	25/12/2020 19:36	26/12/2020 10:05	14,47	10	144,70	CHI
202012146772	ARENOPOLIS	AY12139436	ARENOPOLIS	25/12/2020 19:36	26/12/2020 10:05	25/12/2020 19:36	26/12/2020 10:05	14,47	16	231,52	CHI
202012146631	MIMOSO DE GOIAS	PB12095000	PADRE BERNARDO	25/12/2020 19:41	25/12/2020 22:54	25/12/2020 19:41	25/12/2020 22:54	3,21	48	154,20	CHI
202012146631	VILA PROPICIO	PB12095000	PADRE BERNARDO	25/12/2020 19:41	25/12/2020 22:54	25/12/2020 19:41	25/12/2020 22:54	3,21	9	28,91	CHI
202012146631	PADRE BERNARDO	PB12095000	PADRE BERNARDO	25/12/2020 19:41	25/12/2020 22:54	25/12/2020 19:41	25/12/2020 22:54	3,21	37	118,86	CHI
202012146656	CATURAI	O1760224	TRINDADE	25/12/2020 19:43	26/12/2020 02:58	25/12/2020 19:43	25/12/2020 20:28	0,75	14	10,50	CHI
202012146656	TRINDADE	O1760224	TRINDADE	25/12/2020 19:43	26/12/2020 02:58	25/12/2020 19:43	25/12/2020 20:28	0,75	1664	1248,00	CHI
202012146656	GOIANIRA	O1760224	TRINDADE	25/12/2020 19:43	26/12/2020 02:58	25/12/2020 19:43	25/12/2020 20:28	0,75	53	39,75	CHI
202012146656	SANTA BARBARA DE GOIAS	O1760224	TRINDADE	25/12/2020 19:43	26/12/2020 02:58	25/12/2020 19:43	25/12/2020 20:28	0,75	25	18,75	CHI
202012146656	SANTA BARBARA DE GOIAS	TR16423877	TRINDADE	25/12/2020 19:43	26/12/2020 02:58	25/12/2020 19:43	25/12/2020 20:28	0,76	23	17,58	CHI
202012146656	GOIANIA	TR16423877	TRINDADE	25/12/2020 19:43	26/12/2020 02:58	25/12/2020 19:43	25/12/2020 20:28	0,76	55	42,04	CHI
202012146656	TRINDADE	TR16423877	TRINDADE	25/12/2020 19:43	26/12/2020 02:58	25/12/2020 19:43	25/12/2020 20:28	0,76	12293	9397,32	CHI
202012146656	TRINDADE	TR10406694	TRINDADE	25/12/2020 19:43	26/12/2020 02:58	25/12/2020 19:43	25/12/2020 20:31	0,80	113	90,78	CHI
202012146656	TRINDADE	O1760224	TRINDADE	25/12/2020 19:43	26/12/2020 02:58	25/12/2020 19:43	25/12/2020 21:14	1,52	1036	1572,71	CHI
202012146656	TRINDADE	O1760224	TRINDADE	25/12/2020 19:43	26/12/2020 02:58	25/12/2020 19:43	26/12/2020 02:58	7,26	1635	11877,82	CHI
202012146656	TRINDADE	TR13383425	TRINDADE	25/12/2020 19:43	26/12/2020 02:58	25/12/2020 19:44	26/12/2020 02:58	7,23	24	173,63	CHI
202012146661	FAZENDA NOVA	FN12242280	IPORA	25/12/2020 19:44	26/12/2020 11:40	25/12/2020 19:44	26/12/2020 11:40	15,92	8	127,38	CHI
202012147036	URUTAI	UT12027112RE	PIRES DO RIO S2	25/12/2020 19:45	26/12/2020 10:08	26/12/2020 04:00	26/12/2020 04:38	0,64	2	1,28	CHI
202012147036	URUTAI	UT12027112RE	PIRES DO RIO S2	25/12/2020 19:45	26/12/2020 10:08	25/12/2020 19:45	26/12/2020 10:08	14,39	18	258,96	CHI

202012147036	URUTAI	UT12027112RE	PIRES DO RIO S2	25/12/2020 19:45	26/12/2020 10:08	26/12/2020 07:50	26/12/2020 10:08	2,31	2	4,61	CHI
202012146963	MAMBAI	MB12170571	IACIARA S2	25/12/2020 19:46	26/12/2020 08:42	25/12/2020 19:46	26/12/2020 08:42	12,92	96	1240,19	CHI
202012146713	BONOPOLIS	PO12394943	MARA ROSA	25/12/2020 19:51	27/12/2020 11:52	25/12/2020 19:51	27/12/2020 11:52	40,01	2	80,03	CHI
202012146713	PORANGATU	PO12394943	MARA ROSA	25/12/2020 19:51	27/12/2020 11:52	25/12/2020 19:51	27/12/2020 11:52	40,01	9	360,12	CHI
202012146688	SAO DOMINGOS	SD12161808	SAO DOMINGOS	25/12/2020 19:55	25/12/2020 21:48	25/12/2020 19:55	25/12/2020 21:48	1,88	28	52,73	CHI
202012146692	CALDAS NOVAS	CN12363792	SERRA DE CALDAS	25/12/2020 19:55	25/12/2020 22:28	25/12/2020 19:55	25/12/2020 22:28	2,54	132	335,17	CHI
202012146694	CRIXAS	CX12248300	SERRA DO OURO	25/12/2020 19:55	25/12/2020 22:28	25/12/2020 19:55	25/12/2020 22:28	2,54	4	10,14	CHI
202012146695	PADRE BERNARDO	PB12382965B	PADRE BERNARDO	25/12/2020 19:55	25/12/2020 23:29	25/12/2020 19:55	25/12/2020 23:29	3,55	9	31,96	CHI
202012146722	AMORINOPOLIS	AM12333113	IPORA	25/12/2020 20:01	25/12/2020 22:25	25/12/2020 20:01	25/12/2020 22:25	2,41	8	19,28	CHI
202012146791	ARENOPOLIS	AY12390169	ARENOPOLIS	25/12/2020 20:07	26/12/2020 10:34	25/12/2020 20:07	26/12/2020 10:34	14,44	22	317,61	CHI
202012146791	DIORAMA	AY12390169	ARENOPOLIS	25/12/2020 20:07	26/12/2020 10:34	25/12/2020 20:07	26/12/2020 10:34	14,44	3	43,31	CHI
202012146750	MORRINHOS	150095340	MORRINHOS	25/12/2020 20:08	26/12/2020 00:28	25/12/2020 20:08	26/12/2020 00:28	4,33	1	4,33	CHI
202012146763	EDEALINA	ED12063150	PONTALINA	25/12/2020 20:08	25/12/2020 21:50	25/12/2020 20:08	25/12/2020 21:50	1,69	10	16,86	CHI
202012146762	PIRES DO RIO	PR12000028	PIRES DO RIO S1	25/12/2020 20:10	26/12/2020 16:40	25/12/2020 20:10	26/12/2020 16:40	20,49	5	102,47	CHI
202012146892	PONTALINA	PK12047065	PONTALINA	25/12/2020 20:10	25/12/2020 22:44	25/12/2020 20:10	25/12/2020 22:44	2,55	10	25,53	CHI
202012146768	LUZIANIA	LZ12092802	RIO VERMELHO	25/12/2020 20:11	25/12/2020 20:52	25/12/2020 20:11	25/12/2020 20:52	0,68	294	200,49	CHI
202012146792	ALTO PARAISO DE GOIAS	NQ12234731	NIQUELANDIA SUBTRANSMISSAO	25/12/2020 20:14	26/12/2020 16:27	25/12/2020 20:14	26/12/2020 16:27	20,22	12	242,59	CHI
202012146792	NIQUELANDIA	NQ12234731	NIQUELANDIA SUBTRANSMISSAO	25/12/2020 20:14	26/12/2020 16:27	25/12/2020 20:14	26/12/2020 16:27	20,22	13	262,81	CHI
202012146792	SAO JOAO D ALIANCA	NQ12234731	NIQUELANDIA SUBTRANSMISSAO	25/12/2020 20:14	26/12/2020 16:27	25/12/2020 20:14	26/12/2020 16:27	20,22	1	20,22	CHI
202012146797	SILVANIA	SV12399974	VIANOPOLIS	25/12/2020 20:18	26/12/2020 08:42	25/12/2020 20:18	26/12/2020 08:42	12,39	5	61,94	CHI
202012146801	GOIANIA	11032418	AEROPORTO S2	25/12/2020 20:19	25/12/2020 21:50	25/12/2020 20:19	25/12/2020 21:50	1,51	1	1,51	CHI
202012146806	ITARUMA	IM12370175	ITAJA S2	25/12/2020 20:20	26/12/2020 14:32	25/12/2020 20:20	26/12/2020 14:32	18,20	5	90,99	CHI
202012146819	LUZIANIA	LZ12183557	RIO VERMELHO	25/12/2020 20:25	25/12/2020 21:40	25/12/2020 20:25	25/12/2020 21:40	1,25	153	190,61	CHI
202012146840	FORMOSA	FA11131872	ITUIQUIRA	25/12/2020 20:26	25/12/2020 23:22	25/12/2020 20:26	25/12/2020 23:22	2,93	82	239,87	CHI
202012146845	CRIXAS	CX12297040	SERRA DO OURO	25/12/2020 20:32	26/12/2020 11:05	25/12/2020 20:32	26/12/2020 11:05	14,54	1	14,54	CHI
202012146870	CORUMBA DE GOIAS	CB12114966	CORUMBA	25/12/2020 20:43	26/12/2020 10:42	25/12/2020 20:43	26/12/2020 10:42	13,98	1	13,98	CHI
202012146886	PARAUNA	PU12246343	PARAUNA	25/12/2020 20:48	26/12/2020 08:13	25/12/2020 20:48	26/12/2020 08:13	11,40	1	11,40	CHI
202012146887	ITAPIRAPUA	IU12284913	MATRINCHA	25/12/2020 20:49	26/12/2020 18:59	25/12/2020 20:49	26/12/2020 18:59	22,15	2	44,30	CHI
202012146894	BRITANIA	BT12250825	BRITANIA	25/12/2020 20:53	26/12/2020 07:16	25/12/2020 20:53	26/12/2020 07:16	10,37	4	41,48	CHI
202012146918	CACHOEIRA DOURADA	CD21012628	CACHOEIRA DOURADA	25/12/2020 20:58	25/12/2020 21:14	25/12/2020 20:58	25/12/2020 21:14	0,26	2	0,53	CHI
202012146924	LUZIANIA	KR12261706	PAMPLONA	25/12/2020 21:03	26/12/2020 00:12	25/12/2020 21:03	26/12/2020 00:12	3,13	4	12,54	CHI
202012146925	JATAI	290206145	JATAI S2	25/12/2020 21:03	25/12/2020 23:30	25/12/2020 21:03	25/12/2020 23:30	2,44	1	2,44	CHI
202012146928	SAO FRANCISCO DE GOIAS	SF12211814	SAO FRANCISCO DE GOIAS	25/12/2020 21:03	26/12/2020 03:56	25/12/2020 21:03	26/12/2020 03:56	6,88	15	103,21	CHI
202012146927	LUZIANIA	LZ21241075	VIANOPOLIS	25/12/2020 21:05	25/12/2020 22:20	25/12/2020 21:05	25/12/2020 22:20	1,24	1	1,24	CHI
202012146946	APARECIDA DE GOIANIA	AP11003011	ANHANGUERA	25/12/2020 21:06	26/12/2020 02:31	25/12/2020 21:06	26/12/2020 02:00	4,89	31	151,74	CHI
202012146946	APARECIDA DE GOIANIA	AP16401569	ANHANGUERA	25/12/2020 21:06	26/12/2020 02:31	25/12/2020 22:31	26/12/2020 02:31	4,00	24	96,01	CHI
202012146936	SAO FRANCISCO DE GOIAS	SF12090413	SAO FRANCISCO DE GOIAS	25/12/2020 21:07	26/12/2020 10:28	25/12/2020 21:07	26/12/2020 10:28	13,34	4	53,37	CHI
202012146936	JARAGUA	SF12090413	SAO FRANCISCO DE GOIAS	25/12/2020 21:07	26/12/2020 10:28	25/12/2020 21:07	26/12/2020 10:28	13,34	3	40,03	CHI
202012146939	CAIAPONIA	PH12235320	PIRANHAS	25/12/2020 21:08	26/12/2020 20:06	25/12/2020 21:08	26/12/2020 20:06	22,95	2	45,91	CHI
202012147035	CACHOEIRA ALTA	CA12047662	CACHOEIRA ALTA	25/12/2020 21:11	26/12/2020 01:26	25/12/2020 21:11	26/12/2020 01:26	4,25	4	16,99	CHI
202012146995	VILA PROPICIO	PV12069121	GOIANESIA S1	25/12/2020 21:14	25/12/2020 22:37	25/12/2020 21:14	25/12/2020 22:37	1,38	4	5,51	CHI
202012146994	PETROLINA DE GOIAS	PG12033256	PETROLINA	25/12/2020 21:24	25/12/2020 23:58	25/12/2020 21:24	25/12/2020 23:58	2,55	28	71,45	CHI
202012147000	PIRENOPOLIS	PV12017586	CORUMBA	25/12/2020 21:32	26/12/2020 02:50	25/12/2020 21:32	26/12/2020 02:50	5,29	58	307,03	CHI
202012147005	MUNDO NOVO DE GOIAS	MH12170094	NOVA CRIXAS	25/12/2020 21:37	25/12/2020 23:04	25/12/2020 21:37	25/12/2020 23:04	1,45	4	5,79	CHI
202012147024	APARECIDA DE GOIANIA	AP11204262	INDEPENDENCIA S2	25/12/2020 21:48	26/12/2020 00:40	25/12/2020 21:48	26/12/2020 00:40	2,86	85	243,24	CHI
202012147042	AMARALINA	MU12391672	MARA ROSA	25/12/2020 21:49	26/12/2020 08:02	25/12/2020 21:49	26/12/2020 08:02	10,21	101	1031,38	CHI
202012147042	MUTUNOPOLIS	MU12391672	MARA ROSA	25/12/2020 21:49	26/12/2020 08:02	25/12/2020 21:49	26/12/2020 08:02	10,21	7	71,48	CHI
202012147096	PIRENOPOLIS	PV12382895	CORUMBA	25/12/2020 21:49	26/12/2020 12:21	25/12/2020 21:49	26/12/2020 12:21	14,53	6	87,16	CHI
202012147044	JUSSARA	JR12259541	JUSSARA	25/12/2020 21:56	26/12/2020 14:50	25/12/2020 21:56	26/12/2020 14:50	16,90	7	118,33	CHI
202012147050	IPORA	IR12032738	IPORA	25/12/2020 22:00	26/12/2020 05:15	25/12/2020 22:00	26/12/2020 05:15	7,24	8	57,95	CHI
202012147051	FLORES DE GOIAS	FB12211537	IACIARA S2	25/12/2020 22:00	26/12/2020 08:48	25/12/2020 22:00	26/12/2020 08:48	10,79	56	604,08	CHI

202012147057	URUACU	UR12405303	MARA ROSA	25/12/2020 22:01	26/12/2020 13:22	25/12/2020 22:01	26/12/2020 12:26	14,40	32	460,95	CHI
202012147057	URUACU	UR12243628	MARA ROSA	25/12/2020 22:01	26/12/2020 13:22	25/12/2020 22:01	26/12/2020 13:22	15,34	1	15,34	CHI
202012147138	RIO VERDE	RV12226320LD	RIO VERDE S1	25/12/2020 22:17	26/12/2020 01:42	25/12/2020 22:17	26/12/2020 01:42	3,40	175	595,73	CHI
202012147173	JATAI	JT12358917	JATAI S1	25/12/2020 22:18	26/12/2020 09:45	25/12/2020 22:18	26/12/2020 09:45	11,44	7	80,05	CHI
202012147173	CAIAPONIA	JT12358917	JATAI S1	25/12/2020 22:18	26/12/2020 09:45	25/12/2020 22:18	26/12/2020 09:45	11,44	1	11,44	CHI
202012147121	CRISTALINA	7515050	CRISTALINA S2	25/12/2020 22:54	26/12/2020 00:06	26/12/2020 00:00	26/12/2020 00:06	0,09	105	9,42	CHI
202012147121	IPAMERI	7515050	CRISTALINA S2	25/12/2020 22:54	26/12/2020 00:06	26/12/2020 00:00	26/12/2020 00:06	0,09	100	8,97	CHI
202012147131	ANAPOLIS	AN12321084	ANAPOLIS UNIVERSITARIO S1	25/12/2020 23:08	26/12/2020 06:46	25/12/2020 23:08	26/12/2020 06:46	7,63	7	53,41	CHI
202012147145	SAO MIGUEL DO ARAGUAIA	SM12100371	SAO MIGUEL DO ARAGUAIA	25/12/2020 23:21	26/12/2020 12:27	25/12/2020 23:21	26/12/2020 12:27	13,08	75	981,35	CHI
202012147146	FORMOSO	FO12285186	PORANGATU	25/12/2020 23:22	26/12/2020 03:00	25/12/2020 23:22	26/12/2020 03:00	3,63	82	297,32	CHI
202012147153	RUBIATABA	RB12060965	RUBIATABA	25/12/2020 23:25	26/12/2020 11:57	25/12/2020 23:25	26/12/2020 08:18	8,88	33	292,90	CHI
202012147153	RUBIATABA	RB12060965	RUBIATABA	25/12/2020 23:25	26/12/2020 11:57	25/12/2020 23:25	26/12/2020 10:47	11,37	6	68,22	CHI
202012147153	RUBIATABA	RB12060965	RUBIATABA	25/12/2020 23:25	26/12/2020 11:57	25/12/2020 23:25	26/12/2020 11:25	12,00	7	84,01	CHI
202012147153	RUBIATABA	RB12060965	RUBIATABA	25/12/2020 23:25	26/12/2020 11:57	25/12/2020 23:25	26/12/2020 11:57	12,53	10	125,28	CHI
202012147165	MONTIVIDIU	MV11153901	MONTIVIDIU T	25/12/2020 23:51	26/12/2020 01:07	25/12/2020 23:51	26/12/2020 01:07	1,25	123	153,89	CHI
202012147180	MINEIROS	MY21274019	PARQUE DAS EMAS	26/12/2020 00:15	26/12/2020 11:38	26/12/2020 00:15	26/12/2020 11:38	11,37	1	11,37	CHI
202012147197	MAURILANDIA	RV12026891	SANTA HELENA S1	26/12/2020 01:13	26/12/2020 03:20	26/12/2020 01:13	26/12/2020 03:20	2,12	6	12,70	CHI
202012147216	PETROLINA DE GOIAS	O1450224	PETROLINA	26/12/2020 02:35	26/12/2020 13:56	26/12/2020 02:35	26/12/2020 08:51	6,27	512	3208,25	CHI
202012147216	SAO FRANCISCO DE GOIAS	O1450224	PETROLINA	26/12/2020 02:35	26/12/2020 13:56	26/12/2020 02:35	26/12/2020 08:51	6,27	34	213,05	CHI
202012147216	PETROLINA DE GOIAS	O1450224	PETROLINA	26/12/2020 02:35	26/12/2020 13:56	26/12/2020 02:35	26/12/2020 13:46	11,18	1	11,18	CHI
202012147216	PETROLINA DE GOIAS	O1450224	PETROLINA	26/12/2020 02:35	26/12/2020 13:56	26/12/2020 02:35	26/12/2020 13:56	11,35	1	11,35	CHI
202012147523	BARRO ALTO	BA12210719	GOIANESIA S1	26/12/2020 02:46	26/12/2020 19:20	26/12/2020 02:46	26/12/2020 19:20	16,56	1	16,56	CHI
202012147523	VILA PROPICIO	BA12210719	GOIANESIA S1	26/12/2020 02:46	26/12/2020 19:20	26/12/2020 02:46	26/12/2020 19:20	16,56	17	281,59	CHI
202012147231	CRISTALINA	O3470424	CRISTALINA S1	26/12/2020 02:59	26/12/2020 20:00	26/12/2020 02:59	26/12/2020 04:47	1,80	17	30,60	CHI
202012147231	CRISTALINA	O3470424	CRISTALINA S1	26/12/2020 02:59	26/12/2020 20:00	26/12/2020 02:59	26/12/2020 13:13	10,25	5	51,23	CHI
202012147231	CRISTALINA	KR10413340	CRISTALINA S1	26/12/2020 02:59	26/12/2020 20:00	26/12/2020 13:00	26/12/2020 13:13	0,23	17	3,84	CHI
202012147231	CRISTALINA	O3470424	CRISTALINA S1	26/12/2020 02:59	26/12/2020 20:00	26/12/2020 02:59	26/12/2020 20:00	17,03	1	17,03	CHI
202012147227	LUZIANIA	LZ11250007	RIO VERMELHO	26/12/2020 03:12	26/12/2020 08:50	26/12/2020 03:12	26/12/2020 08:50	5,63	45	253,34	CHI
202012147235	LUZIANIA	LZ11313688	MARAJOARA	26/12/2020 03:21	26/12/2020 10:31	26/12/2020 03:21	26/12/2020 10:31	7,17	10	71,73	CHI
202012147254	SAO MIGUEL DO ARAGUAIA	SM12013236	SAO MIGUEL DO ARAGUAIA	26/12/2020 03:47	26/12/2020 08:06	26/12/2020 03:47	26/12/2020 08:06	4,32	28	120,84	CHI
202012147283	GOIATUBA	CL18434385TS	RIO DOS BOIS	26/12/2020 04:40	26/12/2020 09:09	26/12/2020 04:40	26/12/2020 09:09	4,47	19	85,01	CHI
202012147283	PORTEIRAO	CL18434385TS	RIO DOS BOIS	26/12/2020 04:40	26/12/2020 09:09	26/12/2020 04:40	26/12/2020 09:09	4,47	13	58,17	CHI
202012147478	ITARUMA	IM12016195	CACHOEIRA ALTA	26/12/2020 04:47	26/12/2020 09:17	26/12/2020 04:47	26/12/2020 09:17	4,50	43	193,32	CHI
202012147478	ITAJA	IM12016195	CACHOEIRA ALTA	26/12/2020 04:47	26/12/2020 09:17	26/12/2020 04:47	26/12/2020 09:17	4,50	20	89,92	CHI
202012147686	JESUPOLIS	JA12040435	SAO FRANCISCO DE GOIAS	26/12/2020 04:48	26/12/2020 19:36	26/12/2020 04:48	26/12/2020 13:20	8,52	1	8,52	CHI
202012147686	JARAGUA	JA12040435	SAO FRANCISCO DE GOIAS	26/12/2020 04:48	26/12/2020 19:36	26/12/2020 04:48	26/12/2020 19:36	14,79	3	44,37	CHI
202012147686	JESUPOLIS	JA12040435	SAO FRANCISCO DE GOIAS	26/12/2020 04:48	26/12/2020 19:36	26/12/2020 04:48	26/12/2020 19:36	14,79	18	266,22	CHI
202012147289	SAO MIGUEL DO ARAGUAIA	SM12228636	SAO MIGUEL DO ARAGUAIA	26/12/2020 04:49	26/12/2020 08:26	26/12/2020 04:49	26/12/2020 08:26	3,61	58	209,32	CHI
202012147294	JATAI	JT12260475	JATAI S1	26/12/2020 04:56	26/12/2020 11:40	26/12/2020 04:56	26/12/2020 11:40	6,73	7	47,09	CHI
202012147294	PEROLANDIA	JT12260475	JATAI S1	26/12/2020 04:56	26/12/2020 11:40	26/12/2020 04:56	26/12/2020 11:40	6,73	3	20,18	CHI
202012147305	GUARINOS	IW21147988	ITAPACI	26/12/2020 05:06	26/12/2020 09:45	26/12/2020 05:06	26/12/2020 09:45	4,65	1	4,65	CHI
202012148940	PIRENOPOLIS	PV12302141	SAO FRANCISCO DE GOIAS	26/12/2020 05:07	26/12/2020 11:16	26/12/2020 05:07	26/12/2020 11:16	6,13	95	582,72	CHI
202012147460	SANTA RITA DO ARAGUAIA	MY12150634	SANTA RITA DO ARAGUAIA	26/12/2020 05:12	26/12/2020 22:45	26/12/2020 05:12	26/12/2020 22:45	17,54	11	192,96	CHI
202012147524	PORTELANDIA	PW12219564	PARQUE DAS EMAS	26/12/2020 05:12	26/12/2020 12:32	26/12/2020 05:12	26/12/2020 12:32	7,34	12	88,09	CHI
202012147524	MINEIROS	PW12219564	PARQUE DAS EMAS	26/12/2020 05:12	26/12/2020 12:32	26/12/2020 05:12	26/12/2020 12:32	7,34	7	51,38	CHI
202012147318	JATAI	JT12062164	JATAI S1	26/12/2020 05:18	26/12/2020 11:04	26/12/2020 05:18	26/12/2020 11:04	5,76	2	11,52	CHI
202012147484	BARRO ALTO	DF12205803	GOIANESIA S1	26/12/2020 05:23	26/12/2020 11:02	26/12/2020 05:23	26/12/2020 11:02	5,64	6	33,81	CHI
202012147484	SANTA RITA DO NOVO DESTINO	DF12205803	GOIANESIA S1	26/12/2020 05:23	26/12/2020 11:02	26/12/2020 05:23	26/12/2020 11:02	5,64	10	56,35	CHI
202012147620	IPAMERI	IP12068500	CRISTALINA S2	26/12/2020 05:23	26/12/2020 08:05	26/12/2020 05:23	26/12/2020 08:05	2,70	7	18,89	CHI
202012147329	CAMPINORTE	CR12234938	PORANGATU	26/12/2020 05:26	26/12/2020 09:31	26/12/2020 05:26	26/12/2020 09:31	4,08	19	77,47	CHI
202012147329	MINACU	CR12234938	PORANGATU	26/12/2020 05:26	26/12/2020 09:31	26/12/2020 05:26	26/12/2020 09:31	4,08	42	171,24	CHI

202012147330	GOIANESIA	GE12297305	GOIANESIA S1	26/12/2020 05:28	26/12/2020 10:00	26/12/2020 05:28	26/12/2020 10:00	4,53	131	593,72	CHI
202012147339	SANTO ANTONIO DA BARRA	BZ12301384LD	ACREUNA	26/12/2020 05:31	26/12/2020 08:15	26/12/2020 05:31	26/12/2020 08:15	2,73	2	5,47	CHI
202012147343	SANTA TEREZA DE GOIAS	SE12352924	MARA ROSA	26/12/2020 05:35	26/12/2020 10:11	26/12/2020 05:35	26/12/2020 10:11	4,59	1	4,59	CHI
202012147343	MUTUNOPOLIS	SE12352924	MARA ROSA	26/12/2020 05:35	26/12/2020 10:11	26/12/2020 05:35	26/12/2020 10:11	4,59	6	27,56	CHI
202012147373	GOUVELANDIA	QI32107357	QUIRINOPOLIS	26/12/2020 05:53	26/12/2020 09:10	26/12/2020 05:53	26/12/2020 09:10	3,27	1	3,27	CHI
202012147637	SAO LUIZ DO NORTE	SZ12330277	GOIANESIA S1	26/12/2020 05:55	26/12/2020 12:26	26/12/2020 05:55	26/12/2020 12:26	6,51	15	97,70	CHI
202012147382	CORUMBA DE GOIAS	CB21144222	CORUMBA	26/12/2020 05:56	26/12/2020 15:30	26/12/2020 05:56	26/12/2020 15:30	9,57	1	9,57	CHI
202012147383	NIQUELANDIA	NQ12280978	URUACU	26/12/2020 05:56	26/12/2020 07:15	26/12/2020 05:56	26/12/2020 07:15	1,30	90	117,13	CHI
202012148008	AMARALINA	MU12394938	MARA ROSA	26/12/2020 05:57	26/12/2020 10:52	26/12/2020 05:57	26/12/2020 10:52	4,90	6	29,42	CHI
202012148008	MUTUNOPOLIS	MU12394938	MARA ROSA	26/12/2020 05:57	26/12/2020 10:52	26/12/2020 05:57	26/12/2020 10:52	4,90	14	68,65	CHI
202012148008	PORANGATU	MU12394938	MARA ROSA	26/12/2020 05:57	26/12/2020 10:52	26/12/2020 05:57	26/12/2020 10:52	4,90	65	318,73	CHI
202012147390	MONTIVIDIU DO NORTE	MX12003844	PORANGATU	26/12/2020 05:58	26/12/2020 07:54	26/12/2020 05:58	26/12/2020 07:54	1,93	743	1431,72	CHI
202012147415	MINEIROS	SX13166013	CHAPADAO DO CEU	26/12/2020 06:05	26/12/2020 09:36	26/12/2020 09:06	26/12/2020 09:36	0,51	20	10,19	CHI
202012147415	SERRANOPOLIS	SX13166013	CHAPADAO DO CEU	26/12/2020 06:05	26/12/2020 09:36	26/12/2020 09:06	26/12/2020 09:36	0,51	5	2,55	CHI
202012147668	CACU	CC12080202	CACHOEIRA ALTA	26/12/2020 06:07	26/12/2020 18:06	26/12/2020 06:07	26/12/2020 18:06	11,97	19	227,42	CHI
202012148604	ITARUMA	IM12039760	CACHOEIRA ALTA	26/12/2020 06:08	26/12/2020 12:09	26/12/2020 06:08	26/12/2020 12:09	6,01	4	24,05	CHI
202012147428	FORMOSO	FO12285186	PORANGATU	26/12/2020 06:11	26/12/2020 10:36	26/12/2020 06:11	26/12/2020 09:50	3,65	9	32,81	CHI
202012147428	FORMOSO	FO12285186	PORANGATU	26/12/2020 06:11	26/12/2020 10:36	26/12/2020 06:11	26/12/2020 10:36	4,42	73	322,32	CHI
202012147430	NIQUELANDIA	NQ12265966	NIQUELANDIA SUBTRANSMISSAO	26/12/2020 06:12	26/12/2020 07:48	26/12/2020 06:12	26/12/2020 07:48	1,60	25	39,97	CHI
202012147434	MUNDO NOVO DE GOIAS	MH12346791	NOVA CRIXAS	26/12/2020 06:12	26/12/2020 07:33	26/12/2020 06:12	26/12/2020 07:33	1,34	4	5,37	CHI
202012149488	MUTUNOPOLIS	MU12076698	MARA ROSA	26/12/2020 06:12	26/12/2020 13:56	26/12/2020 06:12	26/12/2020 13:56	7,73	23	177,69	CHI
202012147448	RUBIATABA	RB12290996	RUBIATABA	26/12/2020 06:15	26/12/2020 08:58	26/12/2020 06:15	26/12/2020 08:58	2,70	9	24,31	CHI
202012147448	ARAGUAPAZ	RB12290996	RUBIATABA	26/12/2020 06:15	26/12/2020 08:58	26/12/2020 06:15	26/12/2020 08:58	2,70	1	2,70	CHI
202012147449	SANTA TEREZINHA DE GOIAS	GG12318452	URUACU	26/12/2020 06:15	26/12/2020 08:25	26/12/2020 06:15	26/12/2020 08:25	2,16	4	8,66	CHI
202012147449	PILAR DE GOIAS	GG12318452	URUACU	26/12/2020 06:15	26/12/2020 08:25	26/12/2020 06:15	26/12/2020 08:25	2,16	87	188,33	CHI
202012147449	GUARINOS	GG12318452	URUACU	26/12/2020 06:15	26/12/2020 08:25	26/12/2020 06:15	26/12/2020 08:25	2,16	1	2,16	CHI
202012147452	ACREUNA	EU12301163	ACREUNA	26/12/2020 06:16	26/12/2020 14:05	26/12/2020 06:16	26/12/2020 14:05	7,80	1	7,80	CHI
202012148296	ITARUMA	IM12191627	CACHOEIRA ALTA	26/12/2020 06:16	26/12/2020 15:37	26/12/2020 06:16	26/12/2020 15:37	9,34	13	121,36	CHI
202012147457	NIQUELANDIA	NQ12264211	NIQUELANDIA SUBTRANSMISSAO	26/12/2020 06:17	26/12/2020 08:05	26/12/2020 06:17	26/12/2020 08:05	1,79	11	19,72	CHI
202012147463	SAO MIGUEL DO ARAGUAIA	SM12099146RE	SAO MIGUEL DO ARAGUAIA	26/12/2020 06:20	26/12/2020 09:01	26/12/2020 06:20	26/12/2020 09:01	2,68	52	139,40	CHI
202012147463	NOVO PLANALTO	SM12099146RE	SAO MIGUEL DO ARAGUAIA	26/12/2020 06:20	26/12/2020 09:01	26/12/2020 06:20	26/12/2020 09:01	2,68	0	0,00	CHI
202012147464	URUACU	UR12147094	CAMPINORTE	26/12/2020 06:20	26/12/2020 09:28	26/12/2020 06:20	26/12/2020 09:28	3,13	2	6,26	CHI
202012147471	RIO VERDE	RV12303875	ACREUNA	26/12/2020 06:21	26/12/2020 09:46	26/12/2020 06:21	26/12/2020 09:46	3,41	29	98,89	CHI
202012147977	PIRENOPOLIS	PV12394331RE	CORUMBA	26/12/2020 06:21	27/12/2020 12:39	26/12/2020 06:21	26/12/2020 15:38	9,29	76	706,42	CHI
202012147977	JARAGUA	PV12394331RE	CORUMBA	26/12/2020 06:21	27/12/2020 12:39	26/12/2020 06:21	26/12/2020 16:45	10,40	3	31,20	CHI
202012147977	JARAGUA	PV12394331RE	CORUMBA	26/12/2020 06:21	27/12/2020 12:39	26/12/2020 06:21	26/12/2020 18:46	12,41	8	99,32	CHI
202012147977	JARAGUA	PV13000445	CORUMBA	26/12/2020 06:21	27/12/2020 12:39	26/12/2020 18:08	26/12/2020 18:46	0,62	3	1,87	CHI
202012147977	JARAGUA	JA21140539	CORUMBA	26/12/2020 06:21	27/12/2020 12:39	27/12/2020 11:01	27/12/2020 12:22	1,34	1	1,34	CHI
202012147977	JARAGUA	PV12394331RE	CORUMBA	26/12/2020 06:21	27/12/2020 12:39	26/12/2020 06:21	27/12/2020 12:32	30,19	1	30,19	CHI
202012147977	JARAGUA	PV12394331RE	CORUMBA	26/12/2020 06:21	27/12/2020 12:39	26/12/2020 06:21	27/12/2020 12:39	30,31	1	30,31	CHI
202012147562	GUARINOS	IW12211868	RUBIATABA	26/12/2020 06:22	26/12/2020 10:41	26/12/2020 06:22	26/12/2020 10:41	4,31	5	21,56	CHI
202012147562	CRIXAS	IW12211868	RUBIATABA	26/12/2020 06:22	26/12/2020 10:41	26/12/2020 06:22	26/12/2020 10:41	4,31	13	56,07	CHI
202012147562	ITAPACI	IW12211868	RUBIATABA	26/12/2020 06:22	26/12/2020 10:41	26/12/2020 06:22	26/12/2020 10:41	4,31	18	77,63	CHI
202012147674	RIO VERDE	QI12279632	QUIRINOPOLIS	26/12/2020 06:27	26/12/2020 16:12	26/12/2020 06:27	26/12/2020 16:12	9,74	15	146,15	CHI
202012147674	CACHOEIRA ALTA	QI12279632	QUIRINOPOLIS	26/12/2020 06:27	26/12/2020 16:12	26/12/2020 06:27	26/12/2020 16:12	9,74	2	19,49	CHI
202012147986	VILA PROPICIO	NP12188681	GOIANESIA S1	26/12/2020 06:27	26/12/2020 17:04	26/12/2020 06:27	26/12/2020 17:04	10,61	92	975,76	CHI
202012147507	MARA ROSA	MQ12192427	MARA ROSA	26/12/2020 06:30	26/12/2020 12:02	26/12/2020 06:30	26/12/2020 12:02	5,52	4	22,08	CHI
202012147513	PADRE BERNARDO	PB12284769	PADRE BERNARDO	26/12/2020 06:31	26/12/2020 11:55	26/12/2020 06:31	26/12/2020 11:55	5,39	69	372,16	CHI
202012147514	RIO VERDE	RV12076338	RIO VERDE S1	26/12/2020 06:31	26/12/2020 09:59	26/12/2020 06:31	26/12/2020 09:59	3,46	8	27,66	CHI
202012147515	MARA ROSA	MQ12380741	SANTA TEREZINHA	26/12/2020 06:31	26/12/2020 10:09	26/12/2020 06:31	26/12/2020 10:09	3,62	13	47,10	CHI
202012148904	ABADIANIA	AA12348132	ANAPOLIS UNIVERSITARIO S1	26/12/2020 06:32	26/12/2020 17:41	26/12/2020 06:32	26/12/2020 17:41	11,14	10	111,41	CHI



202012147540	PADRE BERNARDO	PB12095000	PADRE BERNARDO	26/12/2020 06:36	26/12/2020 09:20	26/12/2020 06:36	26/12/2020 09:20	2,72	37	100,54	CHI
202012147540	MIMOSO DE GOIAS	PB12095000	PADRE BERNARDO	26/12/2020 06:36	26/12/2020 09:20	26/12/2020 06:36	26/12/2020 09:20	2,72	48	130,43	CHI
202012147540	VILA PROPICIO	PB12095000	PADRE BERNARDO	26/12/2020 06:36	26/12/2020 09:20	26/12/2020 06:36	26/12/2020 09:20	2,72	9	24,46	CHI
202012148156	SERRANOPOLIS	SX12166076	JATAI S1	26/12/2020 06:36	26/12/2020 15:31	26/12/2020 06:36	26/12/2020 15:31	8,92	11	98,08	CHI
202012147545	SANTA HELENA DE GOIAS	SH12295844	IPEGUARI	26/12/2020 06:38	26/12/2020 08:25	26/12/2020 06:38	26/12/2020 08:25	1,77	18	31,86	CHI
202012147553	PLANALTINA	PI12202846	PADRE BERNARDO	26/12/2020 06:40	26/12/2020 09:02	26/12/2020 06:40	26/12/2020 09:02	2,36	3	7,09	CHI
202012147615	URUACU	UR12390488	URUACU	26/12/2020 06:41	26/12/2020 08:52	26/12/2020 06:41	26/12/2020 08:52	2,17	36	78,20	CHI
202012148256	SAO MIGUEL DO ARAGUAIA	SM12013036	SAO MIGUEL DO ARAGUAIA	26/12/2020 06:41	26/12/2020 10:10	26/12/2020 06:41	26/12/2020 10:10	3,47	22	76,43	CHI
202012147585	JATAI	8046940	JATAI S1	26/12/2020 06:42	26/12/2020 12:40	26/12/2020 06:42	26/12/2020 12:40	5,96	4	23,83	CHI
202012148242	PIRENOPOLIS	PV12362263	CORUMBA	26/12/2020 06:44	26/12/2020 19:47	26/12/2020 06:44	26/12/2020 19:47	13,04	13	169,47	CHI
202012147590	SERRANOPOLIS	SX12248291	JATAI S1	26/12/2020 06:47	26/12/2020 10:02	26/12/2020 06:47	26/12/2020 10:02	3,25	2	6,49	CHI
202012147592	NOVA CRIXAS	CX12072330	NOVA CRIXAS	26/12/2020 06:47	26/12/2020 11:47	26/12/2020 06:47	26/12/2020 11:47	5,00	5	24,98	CHI
202012147596	TROMBAS	TB12345570	PORANGATU	26/12/2020 06:48	26/12/2020 16:02	26/12/2020 06:48	26/12/2020 11:31	4,73	12	56,71	CHI
202012147596	TROMBAS	TB12345570	PORANGATU	26/12/2020 06:48	26/12/2020 16:02	26/12/2020 06:48	26/12/2020 16:02	9,24	4	36,95	CHI
202012147606	ANAPOLIS	AN12267911	ANAPOLIS UNIVERSITARIO S2	26/12/2020 06:50	26/12/2020 08:33	26/12/2020 06:50	26/12/2020 08:33	1,71	42	71,99	CHI
202012147606	CAMPO LIMPO	AN12267911	ANAPOLIS UNIVERSITARIO S2	26/12/2020 06:50	26/12/2020 08:33	26/12/2020 06:50	26/12/2020 08:33	1,71	2	3,43	CHI
202012147610	MIMOSO DE GOIAS	MJ12305238	PADRE BERNARDO	26/12/2020 06:50	26/12/2020 11:53	26/12/2020 06:50	26/12/2020 11:53	5,04	3	15,12	CHI
202012147610	AGUA FRIA DE GOIAS	MU12305238	PADRE BERNARDO	26/12/2020 06:50	26/12/2020 11:53	26/12/2020 06:50	26/12/2020 11:53	5,04	2	10,08	CHI
202012147612	PORANGATU	PO12391665	PORANGATU	26/12/2020 06:50	26/12/2020 08:42	26/12/2020 06:50	26/12/2020 08:42	1,85	20	37,01	CHI
202012149946	JARAGUA	JA12298107	JARAGUA	26/12/2020 06:51	26/12/2020 18:59	26/12/2020 06:51	26/12/2020 18:59	12,13	3	36,39	CHI
202012148623	RUBIATABA	RB12060966	RUBIATABA	26/12/2020 06:52	26/12/2020 10:55	26/12/2020 06:52	26/12/2020 10:55	4,03	15	60,52	CHI
202012147621	LEOPOLDO DE BULHOES	LB12311926	DAIA S2	26/12/2020 06:53	26/12/2020 10:25	26/12/2020 06:53	26/12/2020 10:25	3,53	23	81,11	CHI
202012147625	APARECIDA DO RIO DOCE	RV12402229	CABRIUVA S2	26/12/2020 06:54	26/12/2020 10:33	26/12/2020 06:54	26/12/2020 10:33	3,65	6	21,87	CHI
202012147625	RIO VERDE	RV12402229	CABRIUVA S2	26/12/2020 06:54	26/12/2020 10:33	26/12/2020 06:54	26/12/2020 10:33	3,65	4	14,58	CHI
202012146741	MUTUNOPOLIS	MU12220645	MARA ROSA	26/12/2020 06:56	26/12/2020 10:27	26/12/2020 06:56	26/12/2020 10:27	3,51	32	112,23	CHI
202012146741	PORANGATU	MU12220645	MARA ROSA	26/12/2020 06:56	26/12/2020 10:27	26/12/2020 06:56	26/12/2020 10:27	3,51	45	157,83	CHI
202012147640	MINEIROS	MY12070299	PARQUE DAS EMAS	26/12/2020 06:56	26/12/2020 09:39	26/12/2020 06:56	26/12/2020 09:39	2,71	27	73,14	CHI
202012148320	LUZIANIA	LZ12372282	RIO VERMELHO	26/12/2020 06:58	26/12/2020 09:49	26/12/2020 06:58	26/12/2020 09:49	2,84	22	62,47	CHI
202012147680	ABADIANIA	AA12285384	ANAPOLIS UNIVERSITARIO S1	26/12/2020 07:02	26/12/2020 08:39	26/12/2020 07:02	26/12/2020 08:39	1,61	108	173,64	CHI
202012147680	GAMELEIRA DE GOIAS	AA12285384	ANAPOLIS UNIVERSITARIO S1	26/12/2020 07:02	26/12/2020 08:39	26/12/2020 07:02	26/12/2020 08:39	1,61	1	1,61	CHI
202012147744	GAMELEIRA DE GOIAS	LB12000008	DAIA S2	26/12/2020 07:02	26/12/2020 08:28	26/12/2020 07:02	26/12/2020 08:28	1,43	16	22,83	CHI
202012147744	SILVANIA	LB12000008	DAIA S2	26/12/2020 07:02	26/12/2020 08:28	26/12/2020 07:02	26/12/2020 08:28	1,43	98	139,81	CHI
202012147744	LEOPOLDO DE BULHOES	LB12000008	DAIA S2	26/12/2020 07:02	26/12/2020 08:28	26/12/2020 07:02	26/12/2020 08:28	1,43	161	229,69	CHI
202012147705	ITARUMA	IM12295758	CACHOEIRA ALTA	26/12/2020 07:05	26/12/2020 09:45	26/12/2020 07:05	26/12/2020 09:45	2,66	3	7,98	CHI
202012147729	JATAI	JT12355226	JATAI S1	26/12/2020 07:09	26/12/2020 13:55	26/12/2020 07:09	26/12/2020 13:55	6,76	5	33,81	CHI
202012147742	PORANGATU	PO12027986	PORANGATU	26/12/2020 07:11	26/12/2020 10:38	26/12/2020 07:11	26/12/2020 10:38	3,44	6	20,64	CHI
202012149289	MINEIROS	MY12209687	PARQUE DAS EMAS	26/12/2020 07:13	26/12/2020 15:12	26/12/2020 07:13	26/12/2020 15:12	7,98	9	71,79	CHI
202012147778	LUZIANIA	LZ12112930	RIO VERMELHO	26/12/2020 07:16	26/12/2020 09:34	26/12/2020 07:16	26/12/2020 09:34	2,29	10	22,89	CHI
202012147797	PLANALTINA	PB12281764	PADRE BERNARDO	26/12/2020 07:20	26/12/2020 11:01	26/12/2020 07:20	26/12/2020 11:01	3,68	13	47,80	CHI
202012148608	SAO MIGUEL DO ARAGUAIA	SM12321016	NOVA CRIXAS	26/12/2020 07:20	26/12/2020 15:41	26/12/2020 07:20	26/12/2020 15:41	8,34	7	58,39	CHI
202012147812	FORMOSO	TB12051886	PORANGATU	26/12/2020 07:22	26/12/2020 13:04	26/12/2020 07:22	26/12/2020 13:04	5,69	2	11,37	CHI
202012147812	TROMBAS	TB12051886	PORANGATU	26/12/2020 07:22	26/12/2020 13:04	26/12/2020 07:22	26/12/2020 13:04	5,69	24	136,45	CHI
202012148303	RIO VERDE	RV12131656	RIO VERDE S1	26/12/2020 07:23	26/12/2020 10:26	26/12/2020 07:23	26/12/2020 10:26	3,05	7	21,34	CHI
202012147817	CACU	CC12035157	CACHOEIRA ALTA	26/12/2020 07:24	26/12/2020 10:32	26/12/2020 07:24	26/12/2020 10:32	3,13	10	31,27	CHI
202012147881	VILA PROPICIO	PV12252676	BARRO ALTO	26/12/2020 07:30	26/12/2020 10:54	26/12/2020 07:30	26/12/2020 10:54	3,40	27	91,68	CHI
202012149650	COCALZINHO DE GOIAS	ZN12284337	COCALZINHO	26/12/2020 07:37	26/12/2020 17:05	26/12/2020 07:37	26/12/2020 17:05	9,45	6	56,70	CHI
202012148756	BONOPOLIS	BX12165447	SAO MIGUEL DO ARAGUAIA	26/12/2020 07:40	27/12/2020 04:24	26/12/2020 07:40	27/12/2020 04:24	20,72	3	62,16	CHI
202012147933	SANTA TEREZINHA DE GOIAS	SG12213046	SANTA TEREZINHA	26/12/2020 07:41	26/12/2020 09:36	26/12/2020 07:41	26/12/2020 09:36	1,91	9	17,20	CHI
202012147933	CAMPOS VERDES	SG12213046	SANTA TEREZINHA	26/12/2020 07:41	26/12/2020 09:36	26/12/2020 07:41	26/12/2020 09:36	1,91	8	15,29	CHI
202012148145	SANTO ANTONIO DA BARRA	RV12301462	ACREUNA	26/12/2020 07:41	26/12/2020 13:11	26/12/2020 07:41	26/12/2020 13:11	5,49	1	5,49	CHI
202012148145	RIO VERDE	RV12301462	ACREUNA	26/12/2020 07:41	26/12/2020 13:11	26/12/2020 07:41	26/12/2020 13:11	5,49	16	87,89	CHI

202012148436	SERRANOPOLIS	SX12123303RE	ITAJA S1	26/12/2020 07:42	26/12/2020 15:28	26/12/2020 07:42	26/12/2020 15:28	7,76	35	271,51	CHI
202012147942	IPIRANGA DE GOIAS	RB12003338	RUBIATABA	26/12/2020 07:43	26/12/2020 09:39	26/12/2020 07:43	26/12/2020 09:39	1,93	1	1,93	CHI
202012147942	ITAPACI	RB12003338	RUBIATABA	26/12/2020 07:43	26/12/2020 09:39	26/12/2020 07:43	26/12/2020 09:39	1,93	10	19,32	CHI
202012147942	RUBIATABA	RB12003338	RUBIATABA	26/12/2020 07:43	26/12/2020 09:39	26/12/2020 07:43	26/12/2020 09:39	1,93	126	243,43	CHI
202012147944	PADRE BERNARDO	PB12109502	PADRE BERNARDO	26/12/2020 07:43	26/12/2020 12:40	26/12/2020 07:43	26/12/2020 12:40	4,94	3	14,83	CHI
202012147962	AMARALINA	MQ12210288	NOVA CRIXAS	26/12/2020 07:45	26/12/2020 10:36	26/12/2020 07:45	26/12/2020 10:36	2,85	6	17,09	CHI
202012147967	ABADIANIA	AA12205050	ANAPOLIS UNIVERSITARIO S1	26/12/2020 07:45	26/12/2020 11:31	26/12/2020 07:45	26/12/2020 11:31	3,75	1	3,75	CHI
202012147969	ANAPOLIS	AN12261233	ANAPOLIS UNIVERSITARIO S2	26/12/2020 07:45	26/12/2020 09:54	26/12/2020 07:45	26/12/2020 09:54	2,13	15	32,02	CHI
202012148649	SANTA RITA DO NOVO DESTINO	GE12006474	BARRO ALTO	26/12/2020 07:45	27/12/2020 02:17	26/12/2020 07:45	27/12/2020 02:17	18,52	6	111,10	CHI
202012148649	SAO LUIZ DO NORTE	GE12006474	BARRO ALTO	26/12/2020 07:45	27/12/2020 02:17	26/12/2020 07:45	27/12/2020 02:17	18,52	1	18,52	CHI
202012148649	GOIANESIA	GE12006474	BARRO ALTO	26/12/2020 07:45	27/12/2020 02:17	26/12/2020 07:45	27/12/2020 02:17	18,52	3	55,55	CHI
202012148792	MINEIROS	MY12244170	PARQUE DAS EMAS	26/12/2020 07:45	26/12/2020 13:48	26/12/2020 07:45	26/12/2020 13:48	6,05	5	30,23	CHI
202012149530	JATAI	JT12008872	JATAI S1	26/12/2020 07:48	26/12/2020 12:47	26/12/2020 07:48	26/12/2020 12:47	4,98	12	59,73	CHI
202012148277	CRIXAS	CX12145539	RUBIATABA	26/12/2020 07:49	26/12/2020 15:37	26/12/2020 07:49	26/12/2020 15:37	7,79	19	148,03	CHI
202012148017	RIO VERDE	MV12160781	MONTIVIDIU T	26/12/2020 07:51	26/12/2020 10:39	26/12/2020 07:51	26/12/2020 10:39	2,79	1	2,79	CHI
202012148055	GOIANESIA	GE12000280	GOIANESIA S2	26/12/2020 07:52	26/12/2020 15:27	26/12/2020 07:52	26/12/2020 15:27	7,57	9	68,10	CHI
202012148055	SANTA ISABEL	GE12000280	GOIANESIA S2	26/12/2020 07:52	26/12/2020 15:27	26/12/2020 07:52	26/12/2020 15:27	7,57	1	7,57	CHI
202012148037	PADRE BERNARDO	PB12330582	PADRE BERNARDO	26/12/2020 07:53	26/12/2020 16:13	26/12/2020 07:53	26/12/2020 16:13	8,32	5	41,61	CHI
202012148051	NIQUELANDIA	NQ12295228	NIQUELANDIA SUBTRANSMISSAO	26/12/2020 07:56	26/12/2020 10:38	26/12/2020 07:56	26/12/2020 10:38	2,70	108	291,30	CHI
202012148063	PORANGATU	PO12349234	MARA ROSA	26/12/2020 07:57	26/12/2020 09:57	26/12/2020 07:57	26/12/2020 09:57	1,99	16	31,77	CHI
202012148065	ANAPOLIS	AN12247602	JUNDIAI S1	26/12/2020 07:58	26/12/2020 09:50	26/12/2020 07:58	26/12/2020 09:50	1,86	114	212,55	CHI
202012148069	MINEIROS	MY12374331	PARQUE DAS EMAS	26/12/2020 07:58	26/12/2020 10:40	26/12/2020 07:58	26/12/2020 10:40	2,69	5	13,43	CHI
202012148774	SAO LUIZ DO NORTE	SZ12236801	BARRO ALTO	26/12/2020 07:59	26/12/2020 12:15	26/12/2020 07:59	26/12/2020 12:15	4,26	22	93,76	CHI
202012148079	CRISTALINA	O3940216	CRISTALINA S2	26/12/2020 08:00	26/12/2020 09:16	26/12/2020 08:00	26/12/2020 09:16	1,25	280	350,78	CHI
202012148403	QUIRINOPOLIS	QI12112137	QUIRINOPOLIS	26/12/2020 08:01	26/12/2020 12:10	26/12/2020 08:01	26/12/2020 12:10	4,14	13	53,81	CHI
202012148094	NIQUELANDIA	NQ12374749	URUACU	26/12/2020 08:02	26/12/2020 11:52	26/12/2020 08:02	26/12/2020 11:52	3,82	2	7,65	CHI
202012148097	JATAI	JT12241750	JATAI S1	26/12/2020 08:02	26/12/2020 13:50	26/12/2020 08:02	26/12/2020 13:50	5,79	1	5,79	CHI
202012148107	CACU	CC21125605	CACHOEIRA ALTA	26/12/2020 08:03	26/12/2020 11:22	26/12/2020 08:03	26/12/2020 11:22	3,31	1	3,31	CHI
202012148111	CRIXAS	CX12140958	SANTA TEREZINHA	26/12/2020 08:04	26/12/2020 19:55	26/12/2020 08:04	26/12/2020 19:55	11,85	9	106,62	CHI
202012148116	NOVA AMERICA	NM12363582	RUBIATABA	26/12/2020 08:04	26/12/2020 12:10	26/12/2020 08:04	26/12/2020 12:10	4,09	3	12,26	CHI
202012148186	ITAPACI	IW12350041	RUBIATABA	26/12/2020 08:05	26/12/2020 11:20	26/12/2020 08:05	26/12/2020 11:20	3,24	11	35,63	CHI
202012148512	COLINAS DO SUL	TI12237374	MINACU	26/12/2020 08:05	26/12/2020 10:16	26/12/2020 08:05	26/12/2020 10:16	2,17	4	8,68	CHI
202012148140	BURITINOPOLIS	SU12301950RE	SANTA RITA DO ARAGUAIA	26/12/2020 08:06	28/12/2020 08:46	26/12/2020 08:06	26/12/2020 23:25	15,31	1	15,31	CHI
202012148140	SANTA RITA DO ARAGUAIA	SU12301950RE	SANTA RITA DO ARAGUAIA	26/12/2020 08:06	28/12/2020 08:46	26/12/2020 08:06	26/12/2020 23:25	15,31	19	290,88	CHI
202012148140	SANTA RITA DO ARAGUAIA	8284523	SANTA RITA DO ARAGUAIA	26/12/2020 08:06	28/12/2020 08:46	26/12/2020 08:06	28/12/2020 08:46	48,67	3	146,01	CHI
202012148143	MUTUNOPOLIS	MU12395763	MARA ROSA	26/12/2020 08:07	26/12/2020 22:38	26/12/2020 08:07	26/12/2020 22:38	14,51	7	101,55	CHI
202012148148	ANAPOLIS	AN11096793	JUNDIAI S1	26/12/2020 08:07	26/12/2020 17:59	26/12/2020 15:50	26/12/2020 17:59	2,13	178	379,93	CHI
202012148180	NOVA CRIXAS	NA12229639	NOVA CRIXAS	26/12/2020 08:11	26/12/2020 10:29	26/12/2020 08:11	26/12/2020 10:29	2,29	2	4,57	CHI
202012148198	CAIAPONIA	RV12030683	MONTIVIDIU T	26/12/2020 08:13	26/12/2020 09:52	26/12/2020 08:13	26/12/2020 09:52	1,64	212	346,86	CHI
202012148198	RIO VERDE	RV12030683	MONTIVIDIU T	26/12/2020 08:13	26/12/2020 09:52	26/12/2020 08:13	26/12/2020 09:52	1,64	3	4,91	CHI
202012149210	PADRE BERNARDO	PB12275452	PADRE BERNARDO	26/12/2020 08:13	26/12/2020 13:05	26/12/2020 08:13	26/12/2020 13:05	4,86	28	135,97	CHI
202012148223	ALEXANIA	AX12308913	CORUMBA	26/12/2020 08:14	26/12/2020 14:15	26/12/2020 08:14	26/12/2020 14:15	6,02	58	349,35	CHI
202012148629	IPAMERI	IP12376252	CRISTALINA S2	26/12/2020 08:15	26/12/2020 11:59	26/12/2020 08:15	26/12/2020 11:59	3,73	20	74,58	CHI
202012148383	JATAI	JT12260439	JATAI S1	26/12/2020 08:18	26/12/2020 09:33	26/12/2020 08:18	26/12/2020 09:33	1,24	2	2,48	CHI
202012149599	JARAGUA	GE12000255	GOIANESIA S2	26/12/2020 08:18	26/12/2020 18:40	26/12/2020 08:18	26/12/2020 18:40	10,35	5	51,75	CHI
202012149599	GOIANESIA	GE12000255	GOIANESIA S2	26/12/2020 08:18	26/12/2020 18:40	26/12/2020 08:18	26/12/2020 18:40	10,35	3	31,05	CHI
202012148286	PARANAIGUARA	PC21308775	QUIRINOPOLIS	26/12/2020 08:24	26/12/2020 11:20	26/12/2020 08:24	26/12/2020 11:20	2,92	2	5,84	CHI
202012148311	SANTA TEREZA DE GOIAS	PO12297140RE	PORANGATU	26/12/2020 08:27	26/12/2020 09:56	26/12/2020 08:27	26/12/2020 09:56	1,47	11	16,19	CHI
202012148311	PORANGATU	PO12297140RE	PORANGATU	26/12/2020 08:27	26/12/2020 09:56	26/12/2020 08:27	26/12/2020 09:56	1,47	16	23,55	CHI
202012148311	TROMBAS	PO12297140RE	PORANGATU	26/12/2020 08:27	26/12/2020 09:56	26/12/2020 08:27	26/12/2020 09:56	1,47	170	250,18	CHI
202012148550	PADRE BERNARDO	PB12389380	PADRE BERNARDO	26/12/2020 08:27	26/12/2020 14:22	26/12/2020 08:27	26/12/2020 14:22	5,91	13	76,77	CHI

202012148336	MONTIVIDIU DO NORTE	MX12003844	PORANGATU	26/12/2020 08:30	26/12/2020 11:08	26/12/2020 08:30	26/12/2020 11:08	2,63	743	1951,61	CHI
202012148365	CAIAPONIA	CP12094701	MONTIVIDIU T	26/12/2020 08:34	26/12/2020 16:20	26/12/2020 08:34	26/12/2020 16:20	7,76	3	23,29	CHI
202012149130	PIRENOPOLIS	PV12362322	CORUMBA	26/12/2020 08:34	26/12/2020 20:37	26/12/2020 08:34	26/12/2020 20:37	12,04	25	301,08	CHI
202012148393	URUACU	UR12327258	MARA ROSA	26/12/2020 08:38	26/12/2020 14:50	26/12/2020 08:38	26/12/2020 14:50	6,19	2	12,38	CHI
202012148516	PORANGATU	PO12064911	NOVO PLANALTO	26/12/2020 08:43	26/12/2020 11:20	26/12/2020 08:43	26/12/2020 11:20	2,60	131	341,15	CHI
202012148587	GUARINOS	GF12317987	SANTA TEREZINHA	26/12/2020 08:44	26/12/2020 11:45	26/12/2020 08:44	26/12/2020 11:45	3,02	7	21,11	CHI
202012148459	CRISTALINA	KR12376152	CRISTALINA S1	26/12/2020 08:46	26/12/2020 15:32	26/12/2020 08:46	26/12/2020 15:32	6,76	3	20,27	CHI
202012148476	RIO VERDE	RV12180252	ACREUNA	26/12/2020 08:48	26/12/2020 15:35	26/12/2020 08:48	26/12/2020 15:35	6,77	3	20,32	CHI
202012148674	CRIXAS	CX12276573	SANTA TEREZINHA	26/12/2020 08:48	26/12/2020 17:15	26/12/2020 08:48	26/12/2020 17:15	8,45	10	84,46	CHI
202012148788	AGUA FRIA DE GOIAS	MJ12040650	PADRE BERNARDO	26/12/2020 08:49	26/12/2020 13:21	26/12/2020 08:49	26/12/2020 13:21	4,53	9	40,73	CHI
202012148788	MIMOSO DE GOIAS	MJ12040650	PADRE BERNARDO	26/12/2020 08:49	26/12/2020 13:21	26/12/2020 08:49	26/12/2020 13:21	4,53	11	49,78	CHI
202012148488	PORANGATU	PO12088782	PORANGATU	26/12/2020 08:50	26/12/2020 12:18	26/12/2020 08:50	26/12/2020 12:18	3,46	5	17,31	CHI
202012148498	CACU	CC11153943	CACHOEIRA ALTA	26/12/2020 08:52	26/12/2020 12:50	26/12/2020 08:52	26/12/2020 12:50	3,95	78	308,38	CHI
202012148500	RIO VERDE	RV12322315LD	CABRIUVA S2	26/12/2020 08:52	26/12/2020 17:50	26/12/2020 08:52	26/12/2020 17:50	8,95	1	8,95	CHI
202012148507	DISTRITO FEDERAL	PB12163215	PADRE BERNARDO	26/12/2020 08:53	26/12/2020 10:40	26/12/2020 08:53	26/12/2020 10:40	1,78	3	5,35	CHI
202012148507	PADRE BERNARDO	PB12163215	PADRE BERNARDO	26/12/2020 08:53	26/12/2020 10:40	26/12/2020 08:53	26/12/2020 10:40	1,78	281	500,73	CHI
202012148517	MINEIROS	MY12303860RE	PARQUE DAS EMAS	26/12/2020 08:54	26/12/2020 21:18	26/12/2020 08:54	26/12/2020 11:03	2,15	7	15,04	CHI
202012148517	MINEIROS	MY12303860RE	PARQUE DAS EMAS	26/12/2020 08:54	26/12/2020 21:18	26/12/2020 11:04	26/12/2020 12:16	1,22	1	1,22	CHI
202012148517	MINEIROS	MY13311788	PARQUE DAS EMAS	26/12/2020 08:54	26/12/2020 21:18	26/12/2020 11:04	26/12/2020 13:55	2,85	2	5,70	CHI
202012148517	MINEIROS	MY12301870LD	PARQUE DAS EMAS	26/12/2020 08:54	26/12/2020 21:18	26/12/2020 11:04	26/12/2020 20:37	9,55	2	19,10	CHI
202012148517	MINEIROS	MY12301848LD	PARQUE DAS EMAS	26/12/2020 08:54	26/12/2020 21:18	26/12/2020 11:04	26/12/2020 21:18	10,23	2	20,47	CHI
202012148521	SANTA TEREZA DE GOIAS	SE21208613	MARA ROSA	26/12/2020 08:54	26/12/2020 20:50	26/12/2020 08:54	26/12/2020 20:50	11,92	1	11,92	CHI
202012148543	QUIRINOPOLIS	QI12296563	QUIRINOPOLIS	26/12/2020 08:57	26/12/2020 12:47	26/12/2020 08:57	26/12/2020 12:47	3,83	5	19,13	CHI
202012148545	CACU	CC12086126LD	CACHOEIRA ALTA	26/12/2020 08:57	27/12/2020 10:29	26/12/2020 08:57	27/12/2020 10:29	25,52	5	127,62	CHI
202012148553	MINEIROS	MY21401112	PARQUE DAS EMAS	26/12/2020 08:59	26/12/2020 18:37	26/12/2020 08:59	26/12/2020 18:37	9,64	1	9,64	CHI
202012148554	PORTEIRAO	CL12246736	RIO DOS BOIS	26/12/2020 08:59	26/12/2020 11:46	26/12/2020 08:59	26/12/2020 11:46	2,78	1	2,78	CHI

5. Plotagem das Ocorrências conforme a Especialização das Chuvas

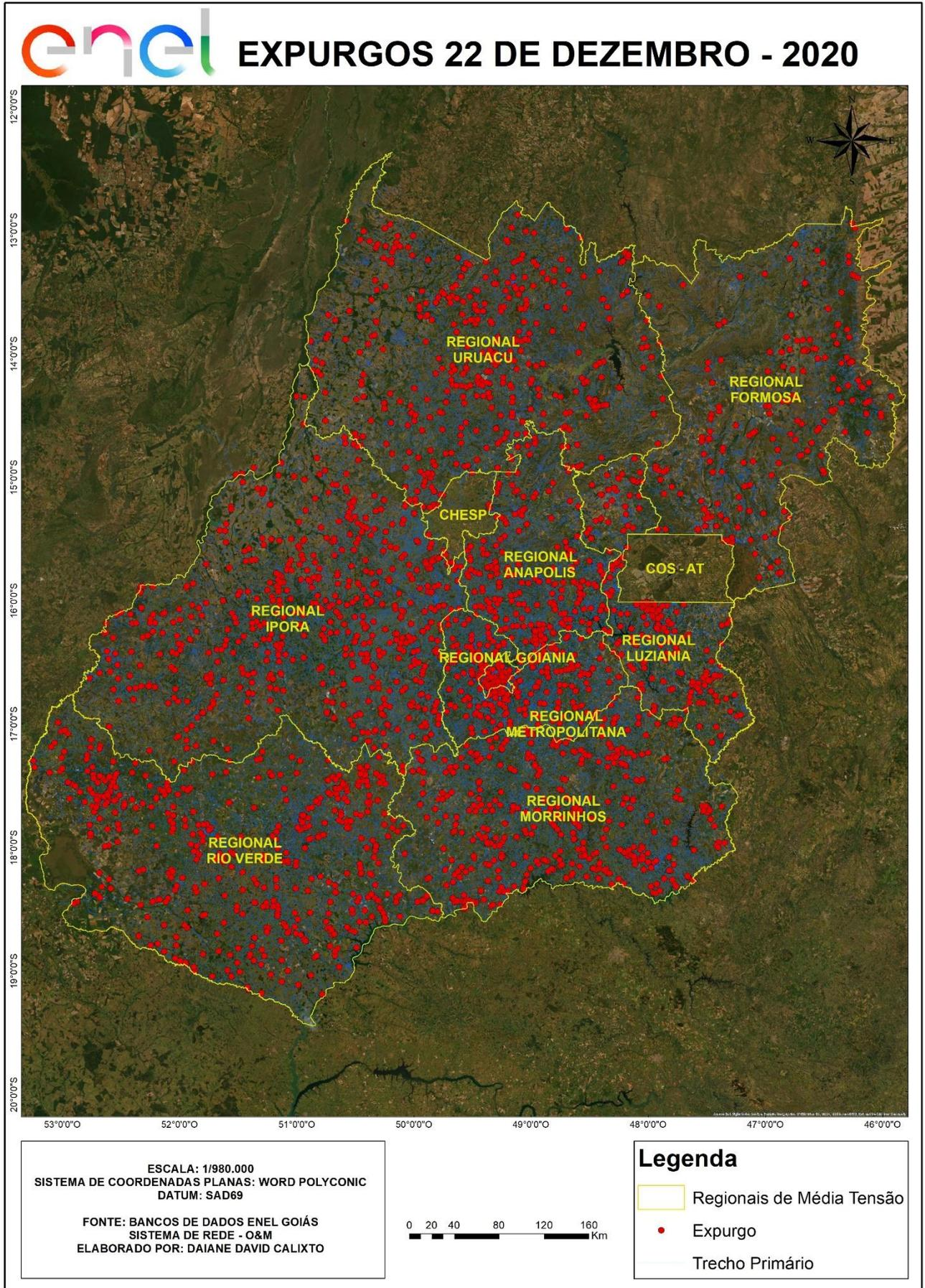

## 6. Clientes Afetados e Impactos Globais

Em análise ao número de clientes interrompidos (CI) na área de concessão da ENEL GO, a figura abaixo apresenta a atipicidade vivenciada nos dias 22 a 26 de dezembro de 2020, data esta que, conforme laudo meteorológico emitido por empresa especializada, a referida concessão passou por um período de condições climáticas de extrema severidade.

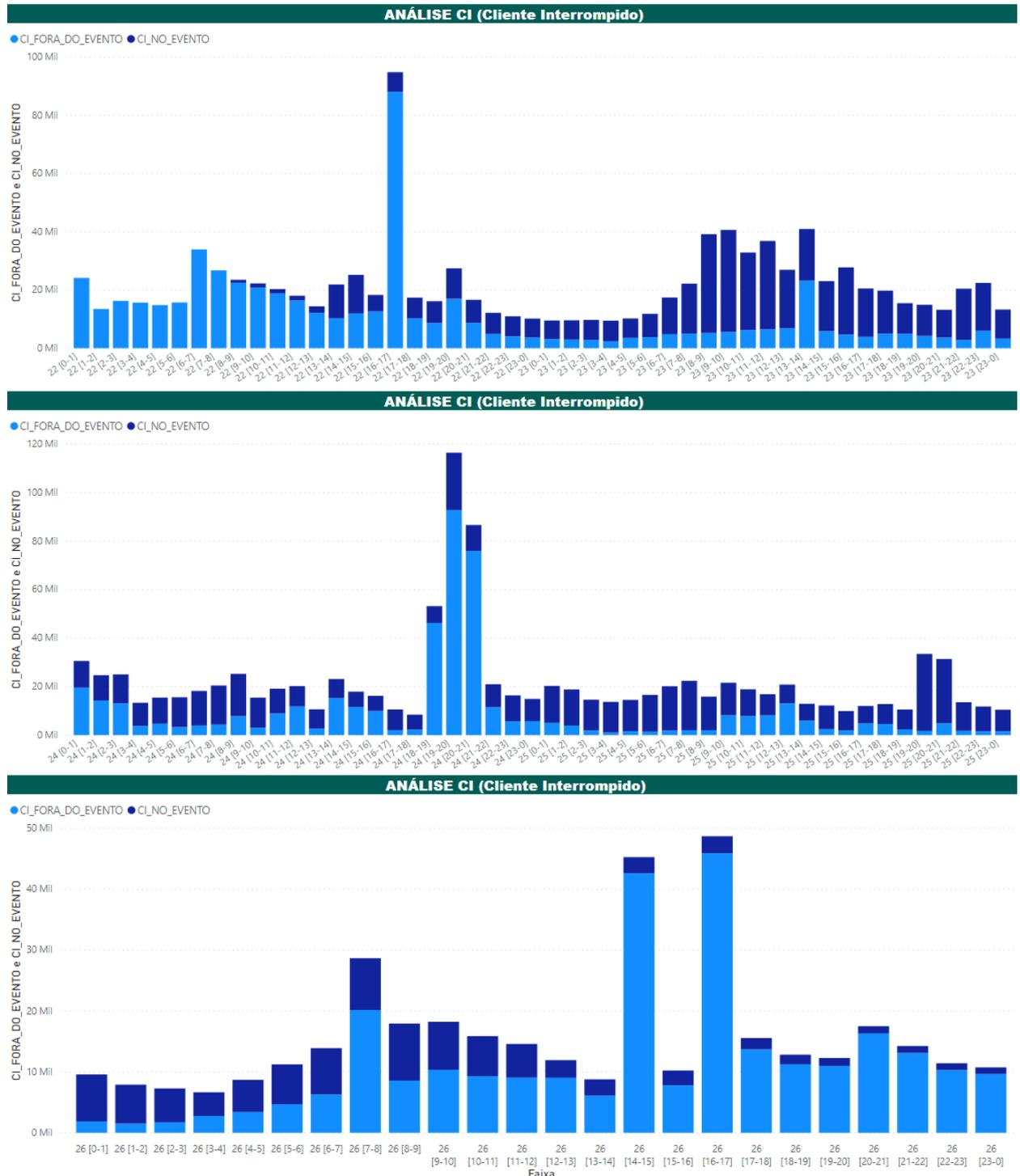

Figuras – Clientes Interrompidos em intervalos de horas

Na figura acima, as barras em azul claro representam a quantidade de clientes interrompidos simultaneamente em condições normais de operação, e as barras azul escuro os clientes interrompidos simultaneamente no período do evento.

## 7. Diagramas Unifilares



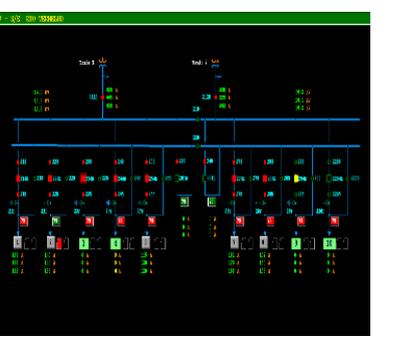
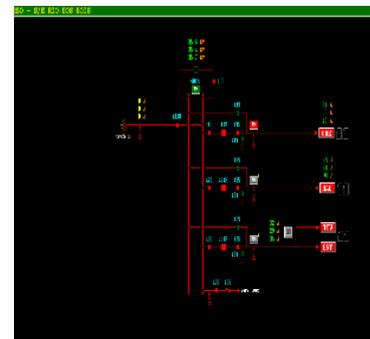
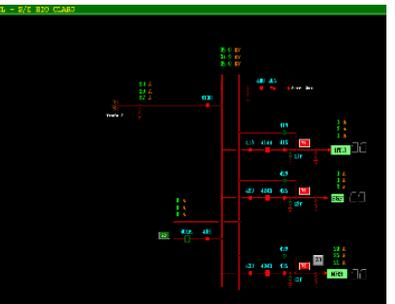
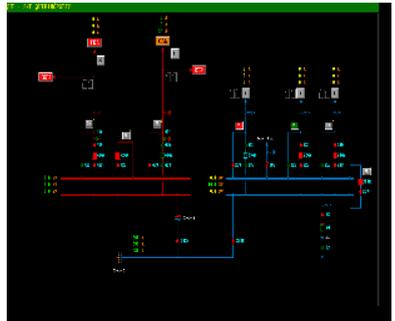
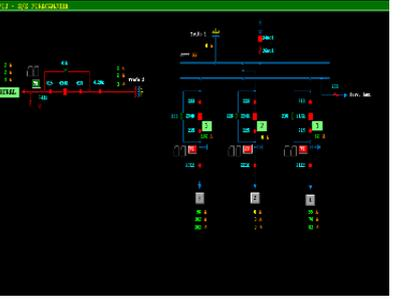
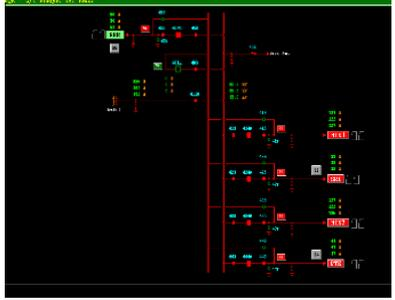
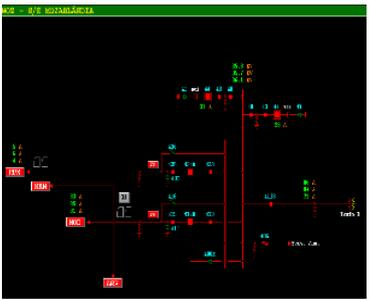
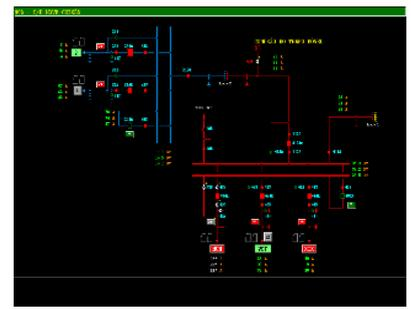

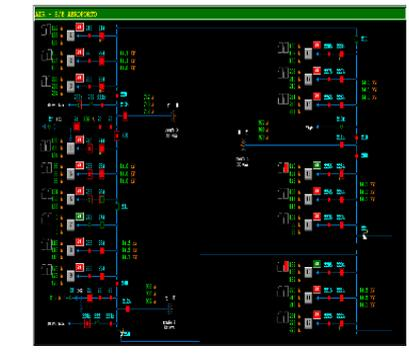
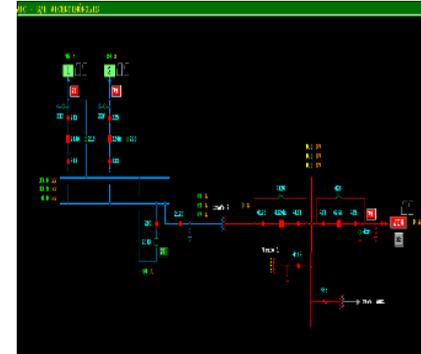
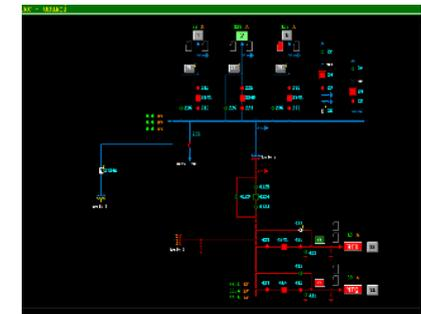
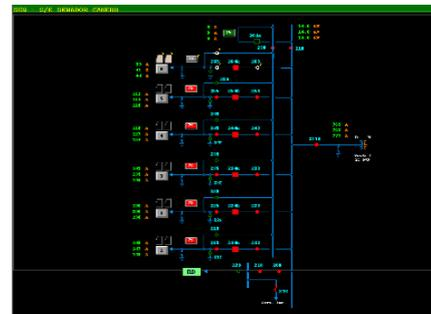
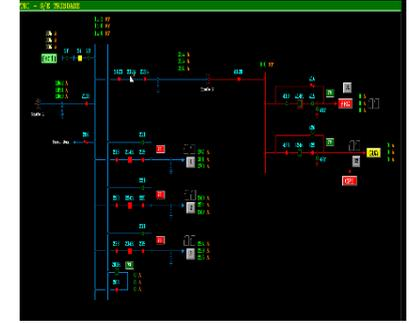
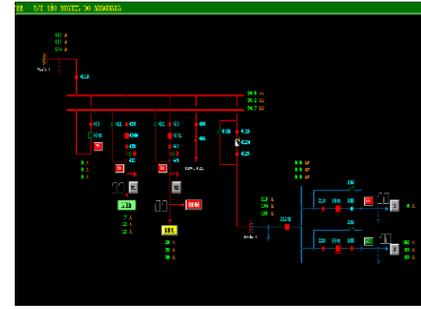
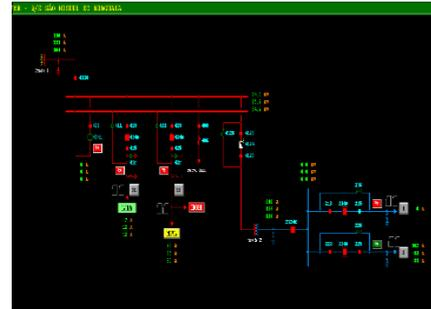
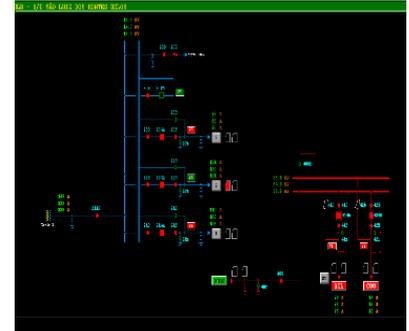
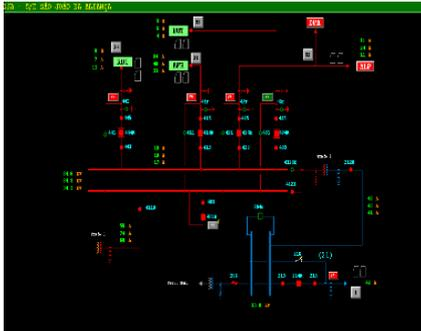
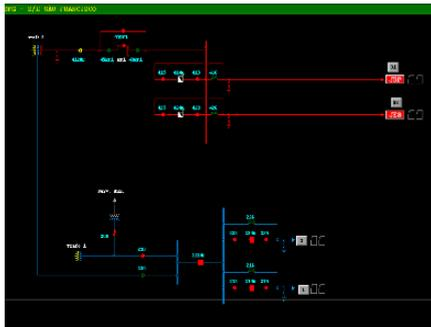
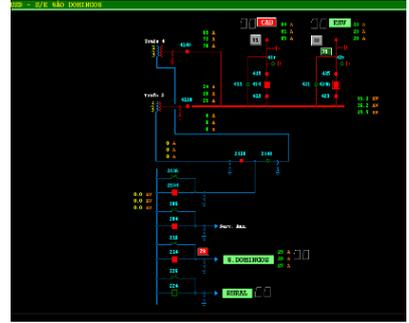
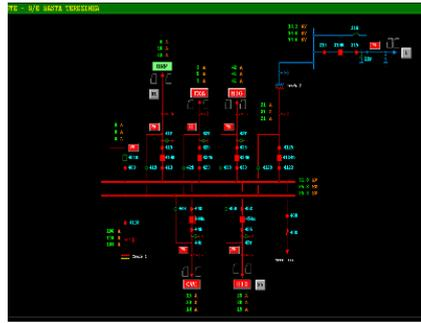
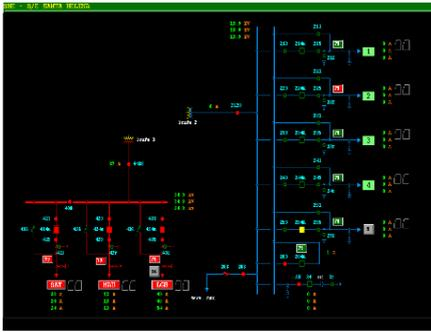



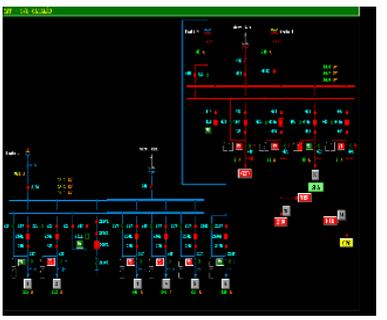
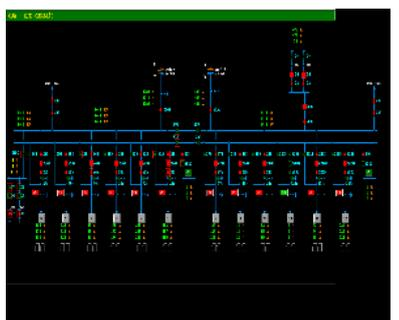
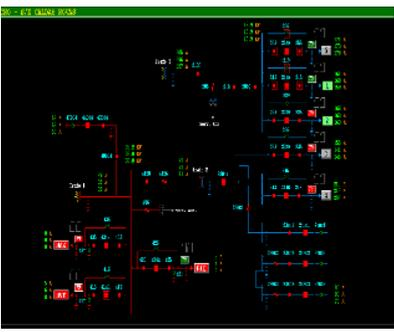
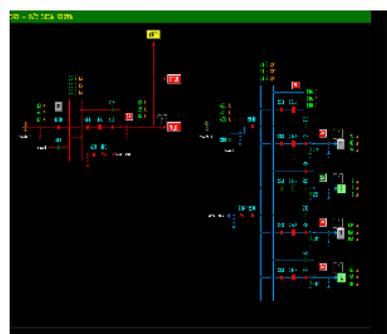
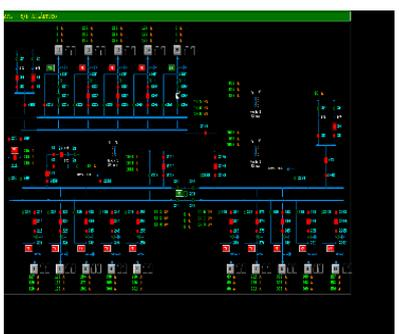
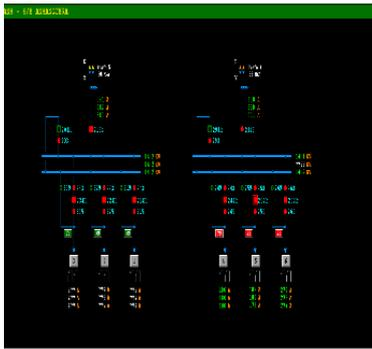
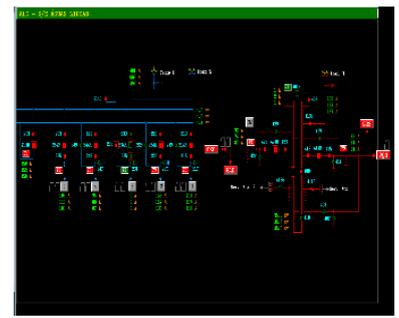
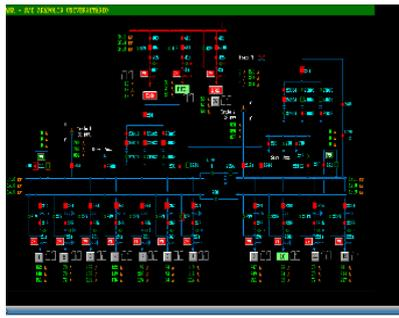

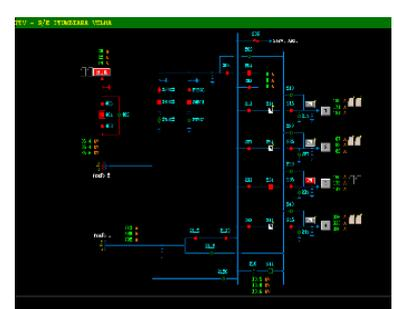
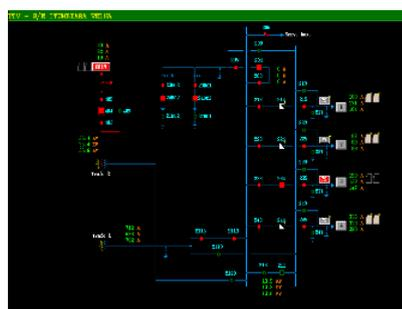
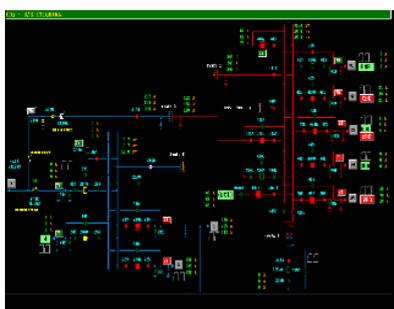
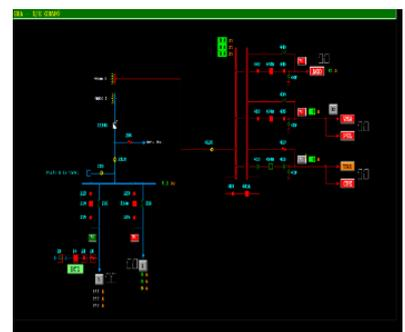
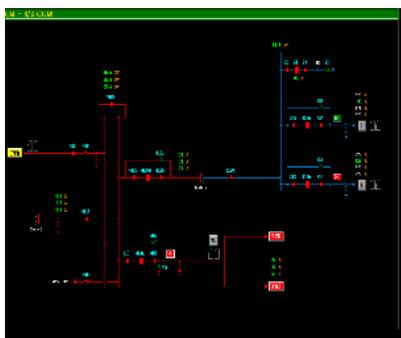
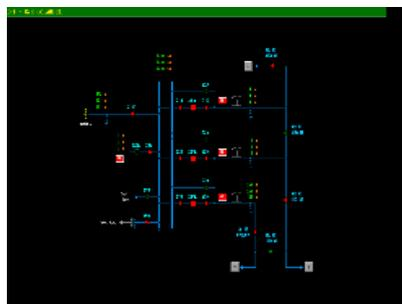
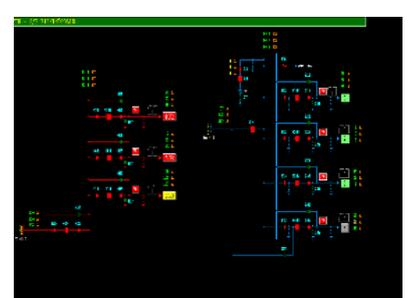
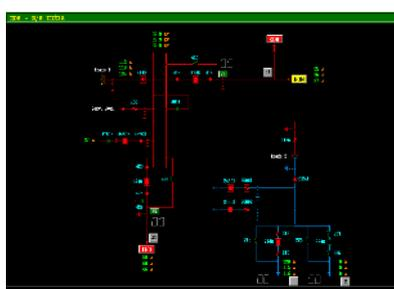
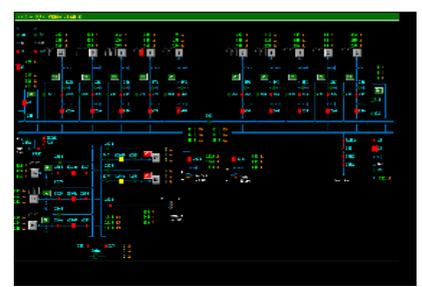
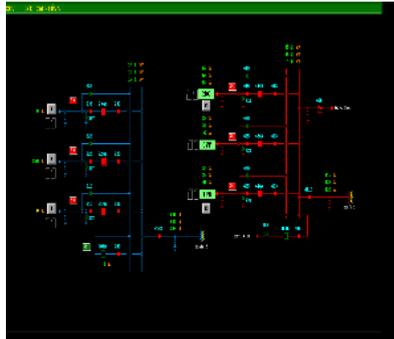
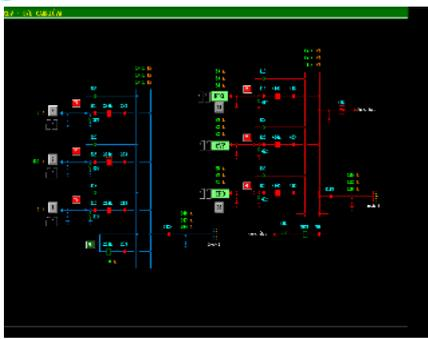

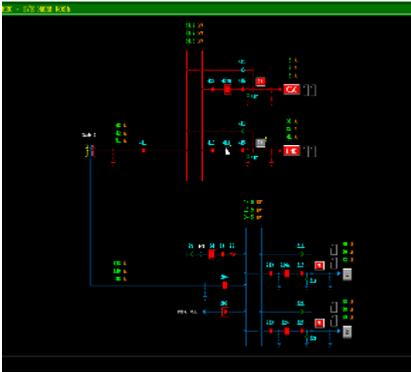
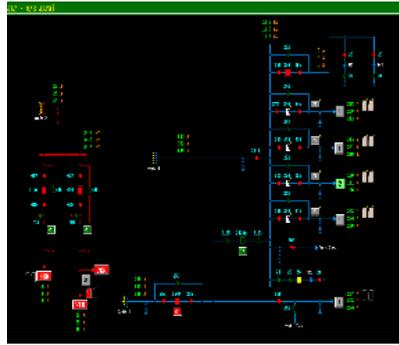
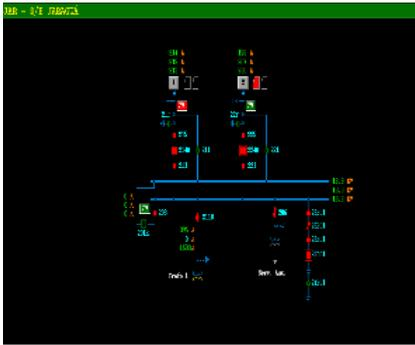

## 8. DEMAIS EVIDÊNCIAS

### 8.1. DADOS TÉCNICO - OPERACIONAIS ENEL GO

Enel - GO

TMAE e OE por Dia - Dezembro 2020

● Contagem de Ocorrências ● TMAE

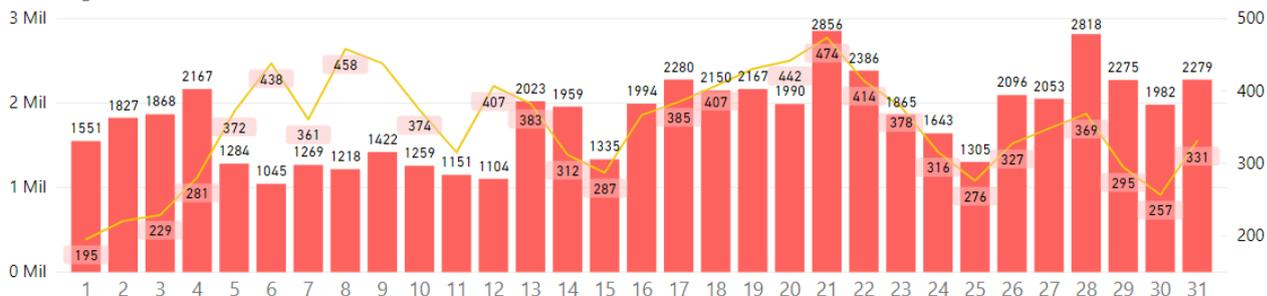

Regional Anápolis – GO

TMAE e OE por Dia - Dezembro 2020

● Contagem de Ocorrências ● TMAE

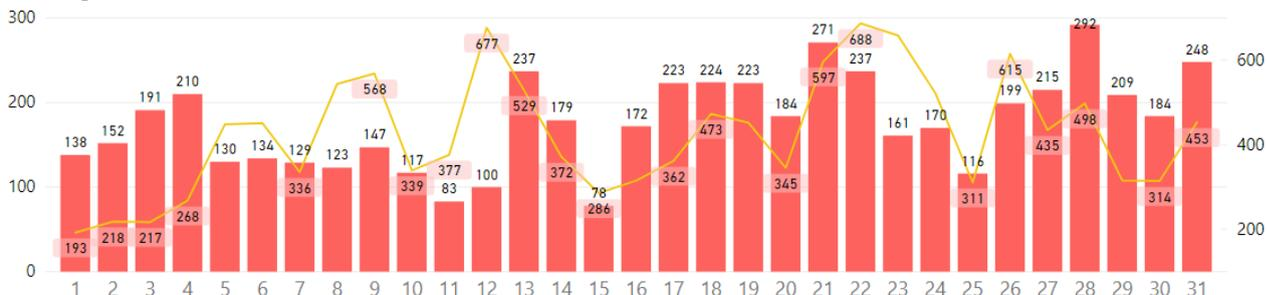

Regional Formosa – GO

TMAE e OE por Dia - Dezembro 2020

● Contagem de Ocorrências ● TMAE

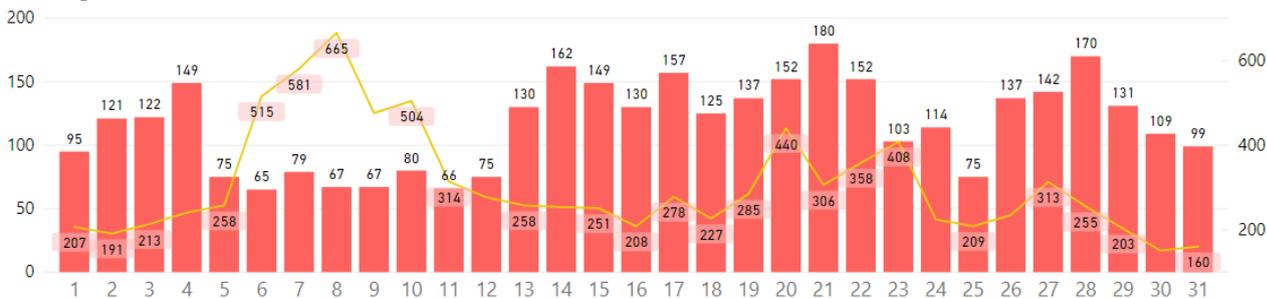

Regional Goiânia – GO

TMAE e OE por Dia - Dezembro 2020

● Contagem de Ocorrências ● TMAE

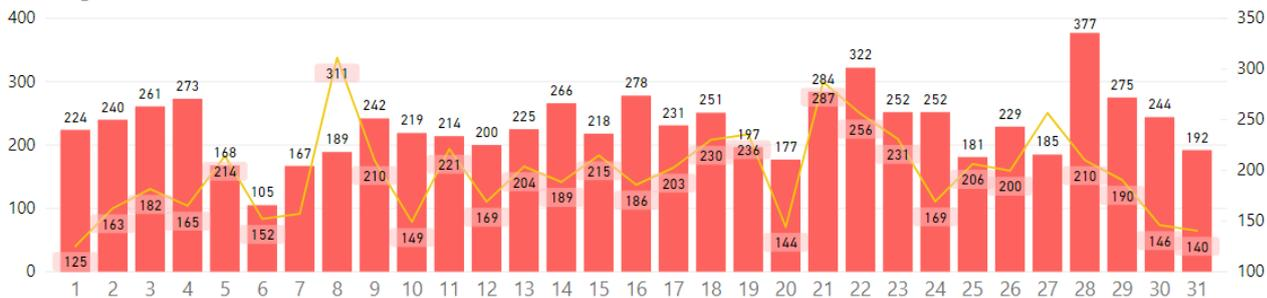

**Regional Iporá – GO**

TMAE e OE por Dia - Dezembro 2020

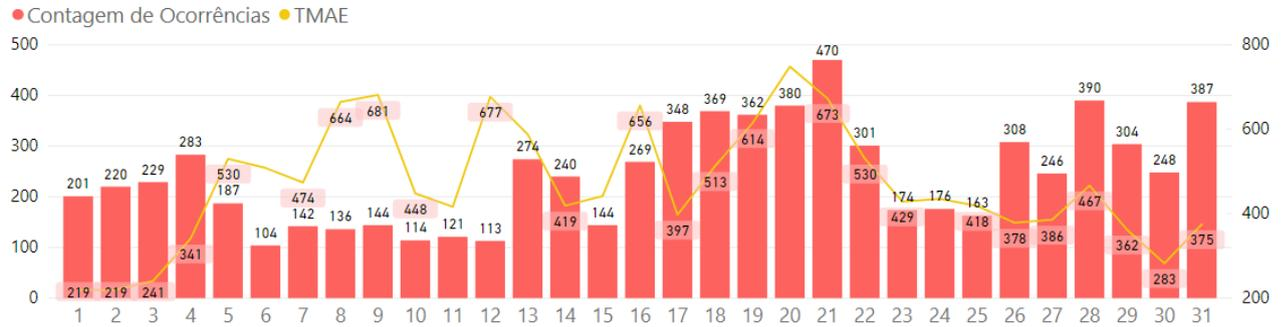

**Regional Luziânia – GO**

TMAE e OE por Dia - Dezembro 2020

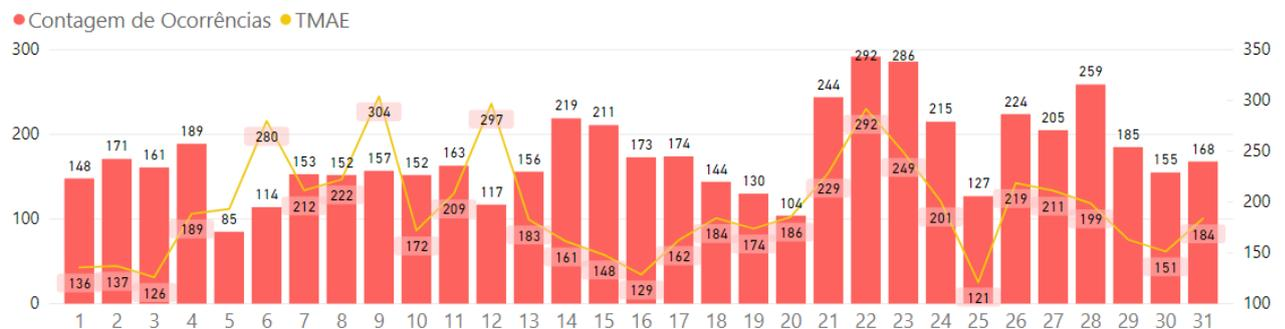

**Regional Metropolitana – GO**

TMAE e OE por Dia - Dezembro 2020

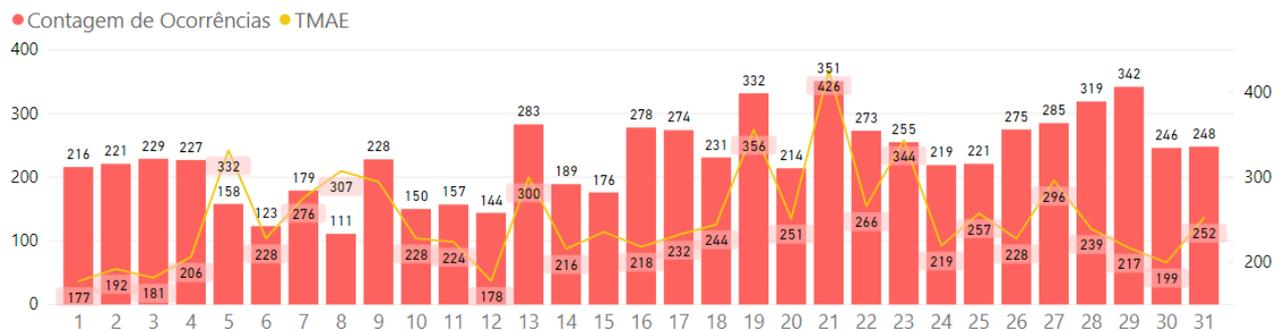

**Regional Morrinhos – GO**

TMAE e OE por Dia - Dezembro 2020

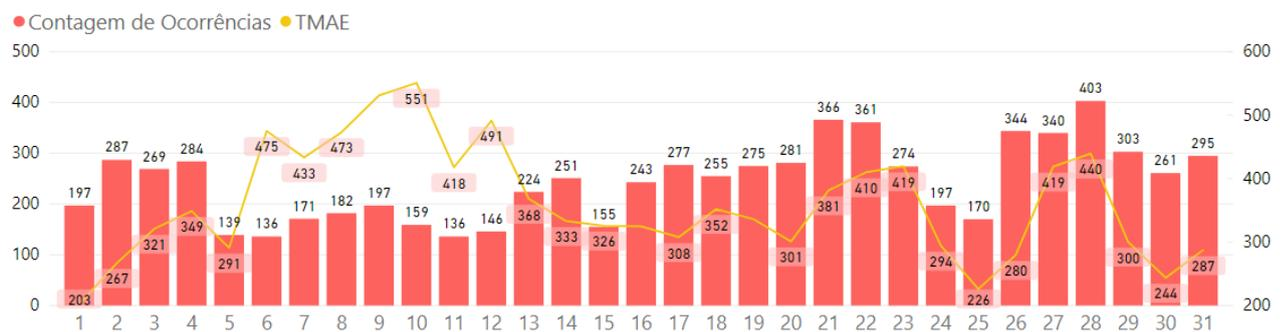

**Regional Rio Verde – GO**

TMAE e OE por Dia - Dezembro 2020

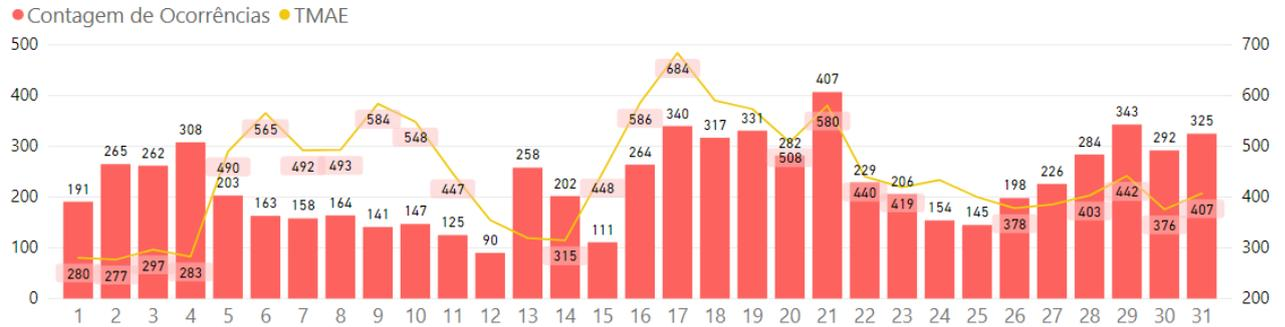

**Regional Uruaçu - GO**

TMAE e OE por Dia - Dezembro 2020

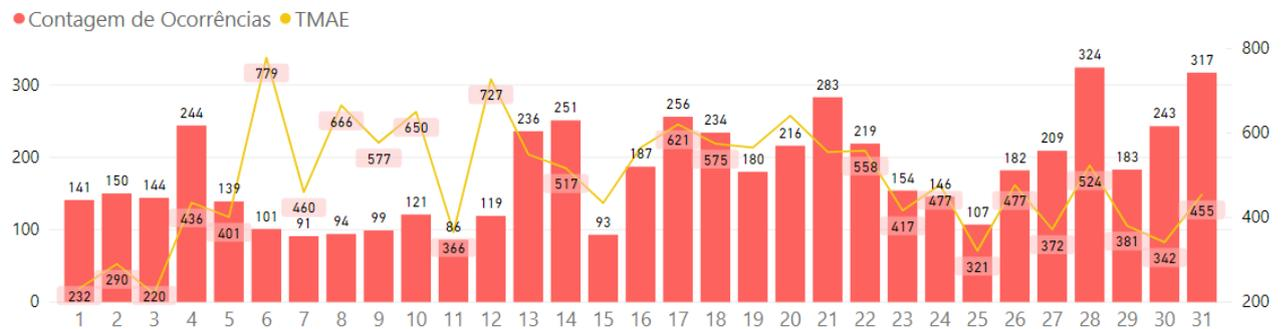

**8.2. Dados climatológicos pelo INMET**

**Instituto Nacional de Meteorologia – INMET**

Chuva Acumulada em 24h || Estação: ARAGARCAS (83368) – 12/2020

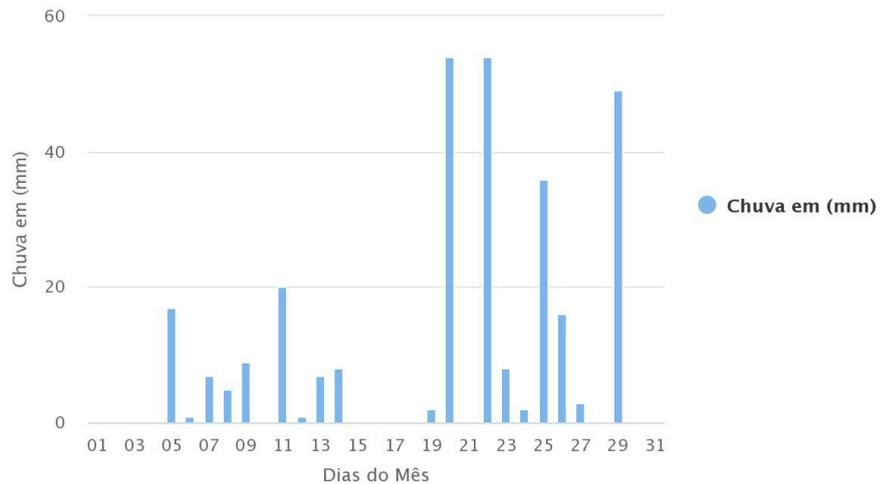

### Instituto Nacional de Meteorologia – INMET

Chuva Acumulada em 24h || Estação: CATALAO (83526) – 12/2020

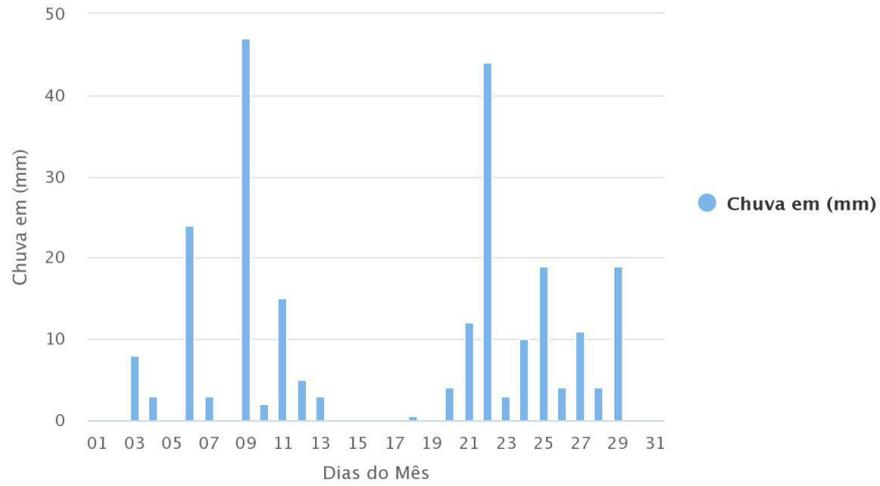

Highcharts.com

### Instituto Nacional de Meteorologia – INMET

Chuva Acumulada em 24h || Estação: FORMOSA (83379) – 12/2020

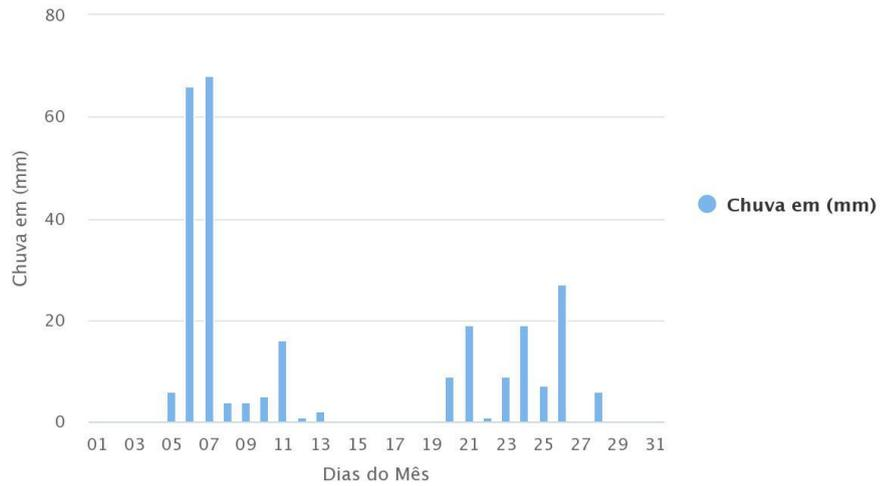

Highcharts.com

### Instituto Nacional de Meteorologia – INMET

Chuva Acumulada em 24h || Estação: GOIANIA (83423) – 12/2020

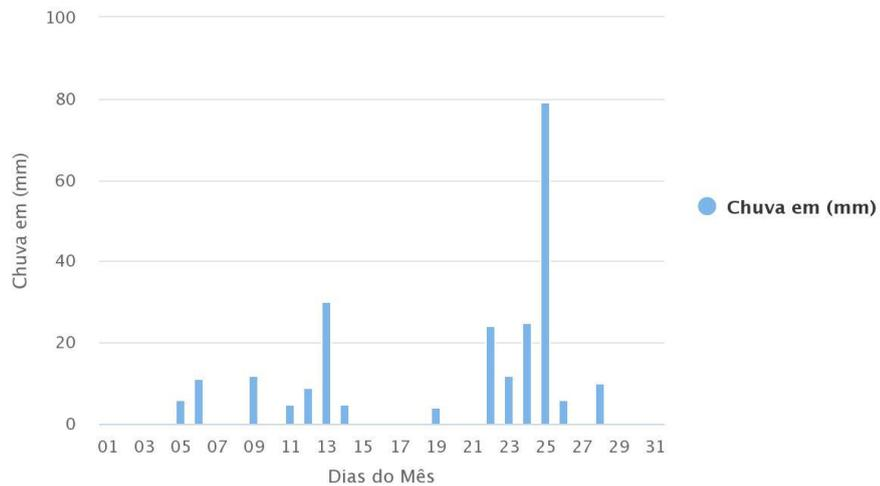

Highcharts.com

### Instituto Nacional de Meteorologia – INMET

Chuva Acumulada em 24h || Estação: IPAMERI (83522) – 12/2020

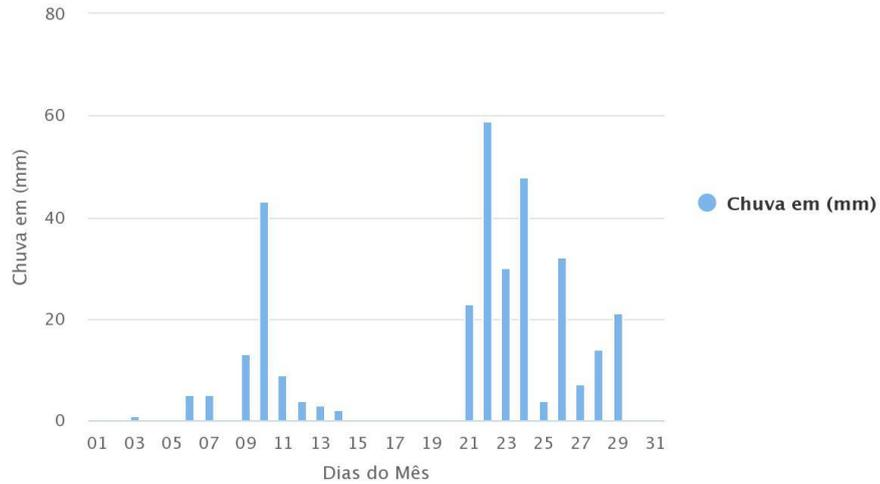

Highcharts.com

### Instituto Nacional de Meteorologia – INMET

Chuva Acumulada em 24h || Estação: JATAI (83464) – 12/2020

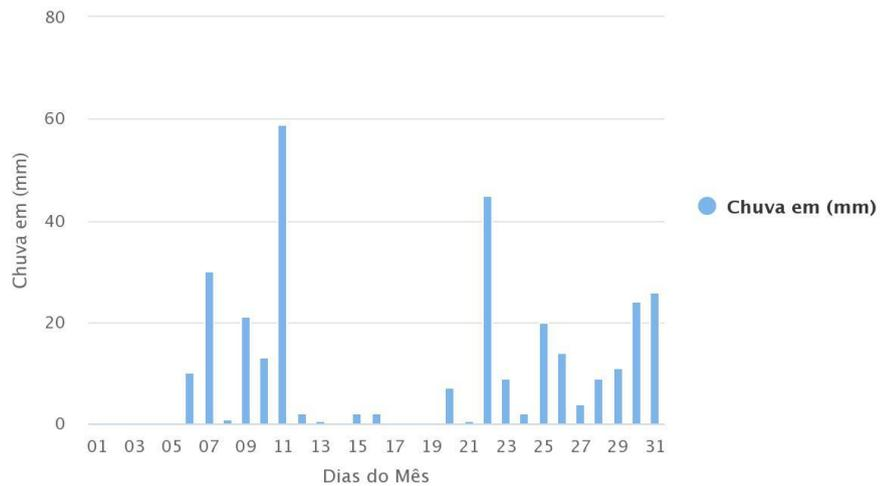

Highcharts.com

### Instituto Nacional de Meteorologia – INMET

Chuva Acumulada em 24h || Estação: PIRENOPOLIS (83376) – 12/2020

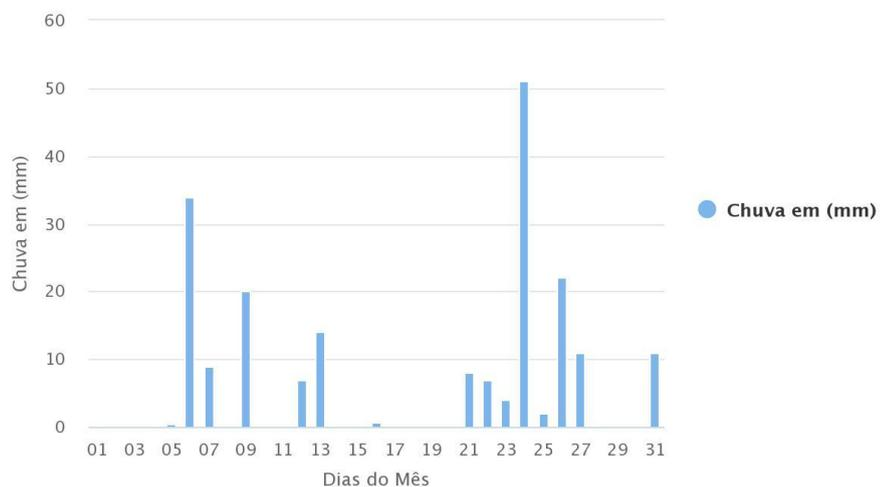

Highcharts.com



### Instituto Nacional de Meteorologia – INMET

Chuva Acumulada em 24h || Estação: POSSE (83332) – 12/2020

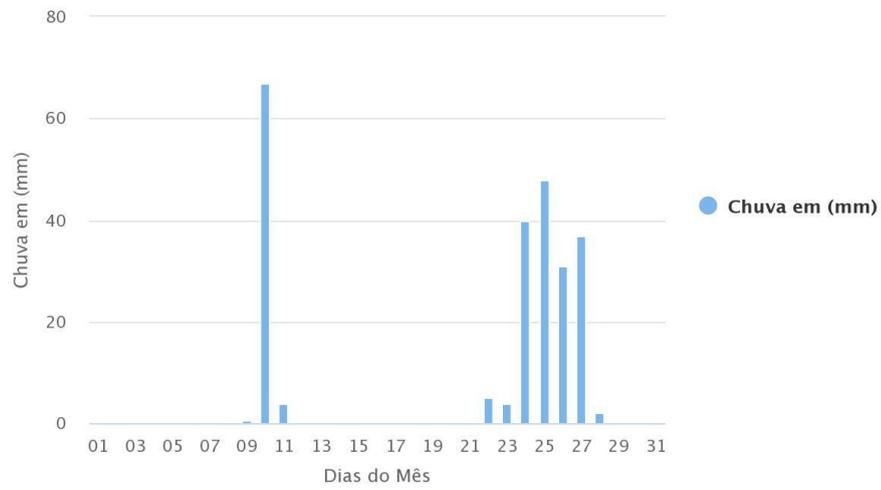

Highcharts.com

### Instituto Nacional de Meteorologia – INMET

Chuva Acumulada em 24h || Estação: RIO VERDE (83470) – 12/2020

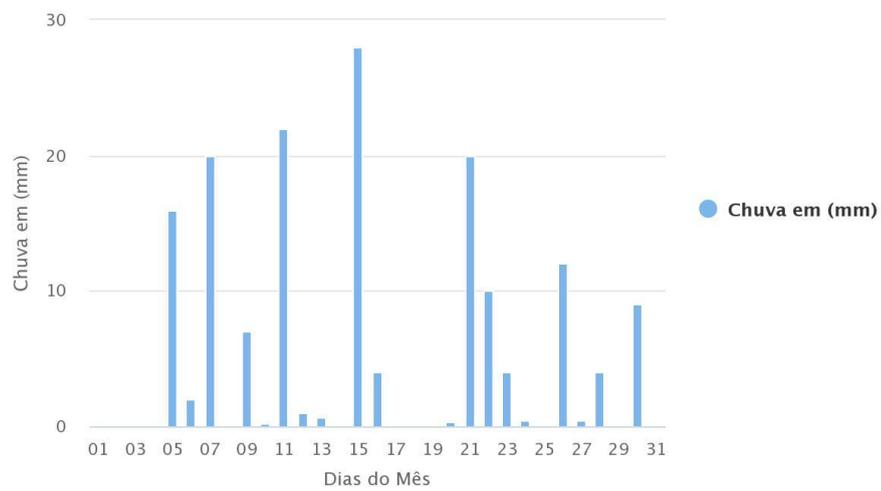

Highcharts.com

## 9. NOTÍCIAS RELACIONADAS

<https://www.instagram.com/p/CJHSI94FqGY/>



**maisgoias** • Seguindo  
Áudio original

**maisgoias** Tempo: situação nesse momento na GO-070, sentido Goianira/Goiânia.

10 sem

+

**esbeniscunha** Literalmente tem que deixar a água abaixar

10 sem Responder

**luizaudisa** Que bom que fica assim pelo menos 10 dias.

10 sem Responder

Curtido por **guivsilvaa** e outras 5.201 pessoas

22 DE DEZEMBRO DE 2020

Adicione um comentário... **Publicar**

[https://www.instagram.com/p/CJHZrqWlo\\_z/](https://www.instagram.com/p/CJHZrqWlo_z/)



**maisgoias** • Seguindo

**maisgoias** Tempo: veja a situação que ficou a cidade de Valparaíso de Goiás, na região do entorno do DF, com a chuva que caiu na tarde desta terça-feira.

10 sem

+

**higorsiqueiras** Não pode reclamar não gente, esses dias tinha gente reclamando que não chovia. Deixa chover, não vem zicar a chuva não!!!

10 sem Responder

Curtido por **eudiegoaugustoo** e outras 19.838 pessoas

22 DE DEZEMBRO DE 2020

Adicione um comentário... **Publicar**

[https://www.instagram.com/p/CJHZrqWlo\\_z/](https://www.instagram.com/p/CJHZrqWlo_z/)

maigoias • Seguindo

maigoias Tempo: veja a situação que ficou a cidade de Valparaíso de Goiás, na região do entorno do DF, com a chuva que caiu na tarde desta terça-feira.

10 sem

higorsiqueiras Não pode reclamar não gente, esses dias tinha gente reclamando que não chovia, Deixa chover, não vem zicar a chuva não!!!

10 sem Responder

Curtido por eudiegoaugustoo e outras 19.838 pessoas

22 DE DEZEMBRO DE 2020

Adicione um comentário... Publicar

[https://www.instagram.com/p/CJHZrqWlo\\_z/](https://www.instagram.com/p/CJHZrqWlo_z/)

maigoias • Seguindo

maigoias Tempo: veja a situação que ficou a cidade de Valparaíso de Goiás, na região do entorno do DF, com a chuva que caiu na tarde desta terça-feira.

10 sem

higorsiqueiras Não pode reclamar não gente, esses dias tinha gente reclamando que não chovia, Deixa chover, não vem zicar a chuva não!!!

10 sem Responder

Curtido por eudiegoaugustoo e outras 19.838 pessoas

22 DE DEZEMBRO DE 2020

Adicione um comentário... Publicar

[https://www.instagram.com/p/CJHZrqWlo\\_z/](https://www.instagram.com/p/CJHZrqWlo_z/)



**maisgoias** • Seguindo

**maisgoias** Tempo: veja a situação que ficou a cidade de Valparaíso de Goiás, na região do entorno do DF, com a chuva que caiu na tarde desta terça-feira.

10 sem

+

**higorsiqueiras** Não pode reclamar não gente, esses dias tinha gente reclamando que não chovia. Deixa chover, não vem zicar a chuva não!!!

10 sem Responder

♥️ 💬 📌

Curtido por eudiegoaugustoo e outras 19.838 pessoas

22 DE DEZEMBRO DE 2020

😊 Adicione um comentário... [Publicar](#)

<https://www.instagram.com/p/CJHwfWFIUzu/>



**maisgoias** • Seguindo

Áudio original

**maisgoias** Tempo: Veja como ficou a Avenida Leão XIII, na Vila Pai Eterno, em Trindade, após a forte chuva que caiu na cidade no final da tarde desta terça-feira. (Vídeo @danielladacostas)

10 sem

+

**nicolau23**  
@prefeituradetrindadeoficial  
@prefeituradetrindade

10 sem Responder

**nicolau23** Interessante as festa lá

♥️ 💬 📌

Curtido por robertbraz\_ e outras 22.007 pessoas

22 DE DEZEMBRO DE 2020

😊 Adicione um comentário... [Publicar](#)

[https://www.instagram.com/p/CJJ\\_BIGjM4Q/](https://www.instagram.com/p/CJJ_BIGjM4Q/)



maisgoiás • Seguindo

maisgoiás Uma represa transbordou, no final da tarde desta terça-feira (22), e alagou um trecho de uma das vias da GO-070, entre os municípios de Goiânia e Goianira. O problema surgiu em virtude das fortes chuvas que atingiram a região e causaram lentidão no trânsito.

Um vídeo divulgado nas redes sociais mostra o momento em que a via está alagada. Nele é possível ver que poucos carros se arriscaram a fazer a travessia.

De acordo com a Agência Goiana de Infraestrutura e Transportes (Goinfra), o problema acontece desde a

Curtido por guivsilvaa e outras 4.437 pessoas

23 DE DEZEMBRO DE 2020

Adicione um comentário... [Publicar](#)

<https://www.instagram.com/p/CJMjDWhFGLo/>



maisgoiás • Seguindo

maisgoiás Tempo: situação na BR-153, nas proximidades da Atlanta

10 sem

+

franciscovjr A BR-153 está para o Goiás assim como a Rota 66 está para os EUA. #route66

10 sem Responder

halinei 🤔

10 sem Responder

italoovaz @brendan\_nf olha como a fiação Brkld

75.408 visualizações

24 DE DEZEMBRO DE 2020

Adicione um comentário... [Publicar](#)

10. Laudo Técnico

CLIMATEMPO

**Laudo Meteorológico de Evento Climático -  
ENEL Goiás - 22 de dezembro de 2020**

São Paulo, SP, Brasil

Janeiro de 2021

# Sumário

<b>1</b>	<b>ANÁLISE DE EVENTO METEOROLÓGICO.....</b>	<b>2</b>
1.1	Descrição do Evento.....	2
1.2	Abrangência do Evento.....	6
<b>2</b>	<b>CLASSIFICAÇÃO COBRADE.....</b>	<b>14</b>
<b>3</b>	<b>RESUMO DO EVENTO.....</b>	<b>15</b>
<b>4</b>	<b>REFERÊNCIAS.....</b>	<b>18</b>
	<b>ANEXOS.....</b>	<b>19</b>

# 1. Análise de Evento Meteorológico

## 1.1. Descrição do Evento

Na figura a seguir é apresentada a área de concessão da ENEL DISTRIBUIÇÃO GOIÁS, dividida em regiões, a serem analisadas neste relatório.



Figura 1 – Regiões atendidas pela ENEL Goiás.

A atuação de uma Zona de Convergência do Atlântico Sul (ZCAS) favoreceu a organização de áreas de instabilidade sobre o estado de Goiás entre os dias 22 e 25 de dezembro de 2020.

Nas Figuras 2 e 3 são apresentadas as descargas atmosféricas nuvem-solo (raios) e nuvem-nuvem detectadas pelo sistema Earth Networks. Entre as 07h45 do dia 22 e 02h00 do dia 26 de dezembro de 2020 foram registrados 27087 raios nuvem-solo e 67022 descargas nuvem-nuvem sobre a área da ENEL DISTRIBUIÇÃO GOIÁS.

Estações do Instituto Nacional de Meteorologia (INMET), representativas da área de concessão da ENEL DISTRIBUIÇÃO GOIÁS, registraram chuva forte (segundo a American Meteorological Society - Sociedade Meteorológica Americana -, chuvas com taxa entre 2,5mm a 7,6 mm por hora são consideradas moderadas e aquelas com taxa superior a 7,6 mm por hora são consideradas chuva forte). Na tabela 2 são apresentados os registros de acumulados horários superiores a 7,6 mm.

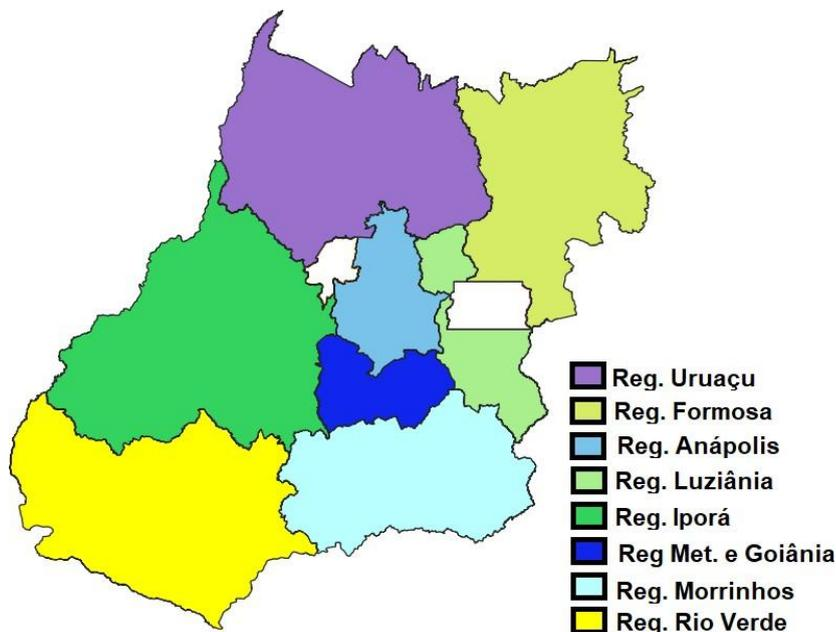



Figura 2 – Descargas atmosféricas nuvem-solo (em preto) detectadas pelo sistema Earth Networks entre 07h45 do dia 22 e 02h00 do dia 26 de dezembro de 2020 sobre a área de concessão da ENEL DISTRIBUIÇÃO GOIÁS.



Figura 3 – Descargas atmosféricas nuvem-nuvem (em vermelho) detectadas pelo sistema Earth Networks entre 07h45 do dia 22 e 02h00 do dia 26 de dezembro de 2020 sobre a área de concessão da ENEL DISTRIBUIÇÃO GOIÁS.

Tabela 1 – Acumulado horário de chuva registrada pelo INMET.

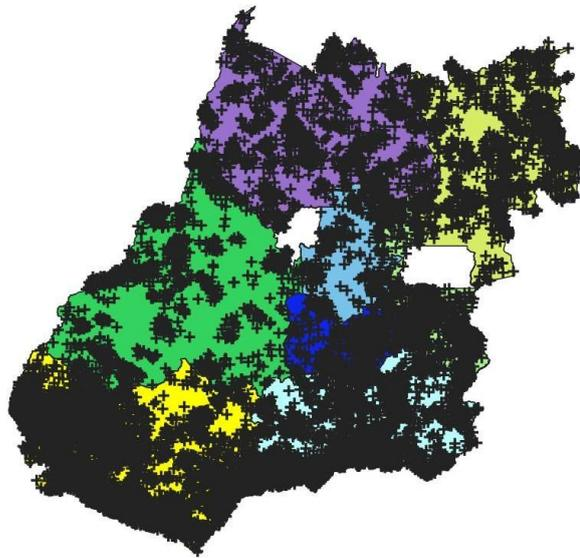
Estação	Horário	Precipitação (mm)
Iporá	Entre 7h e 8h do dia 22/12/2020	8.6
Iporá	Entre 8h e 9h do dia 22/12/2020	9.0
Iporá	Entre 9h e 10h do dia 22/12/2020	9.2
Jataí	Entre 14h e 15h do dia 22/12/2020	8.6
Alto Araguaia	Entre 17h e 18h do dia 22/12/2020	9.6
Goiânia	Entre 17h e 18h do dia 22/12/2020	14.2
Cristalina	Entre 20h e 21h do dia 22/12/2020	27.6
Pires do Rio	Entre 20h e 21h do dia 22/12/2020	10.0
Cristalina	Entre 21h e 22h do dia 22/12/2020	17.6
Pires do Rio	Entre 21h e 22h do dia 22/12/2020	13.8
Pires do Rio	Entre 22h e 23h do dia 22/12/2020	12.8
Itapaci	Entre 6h e 7h do dia 23/12/2020	16.8
Itapaci	Entre 7h e 8h do dia 23/12/2020	20.6
Itapaci	Entre 12h e 13h do dia 23/12/2020	13.0
Paraúna	Entre 12h e 13h do dia 23/12/2020	16.8
Posse	Entre 15h e 16h do dia 23/12/2020	42.8
Monte Alegre de Goiás	Entre 17h e 18h do dia 23/12/2020	10.0
Monte Alegre de Goiás	Entre 18h e 19h do dia 23/12/2020	30.0
Alto Araguaia	Entre 20h e 21h do dia 23/12/2020	8.0
Goiânia	Entre 22h e 23h do dia 23/12/2020	10.0
Pires do Rio	Entre 22h e 23h do dia 23/12/2020	10.8
Itapaci	Entre 12h e 13h do dia 24/12/2020	12.8
Posse	Entre 13h e 14h do dia 24/12/2020	18.4
Jataí	Entre 16h e 17h do dia 24/12/2020	18.8
Morrinhos	Entre 16h e 17h do dia 24/12/2020	36.6
Luziânia	Entre 20h e 21h do dia 24/12/2020	10.6
Posse	Entre 22h e 23h do dia 24/12/2020	34.0
Goiânia	Entre 0h e 1h do dia 25/12/2020	8.4
Morrinhos	Entre 1h e 2h do dia 25/12/2020	13.8
Morrinhos	Entre 2h e 3h do dia 25/12/2020	8.0
Paraúna	Entre 3h e 4h do dia 25/12/2020	16.6
Paraúna	Entre 4h e 5h do dia 25/12/2020	12.8
Itumbiara	Entre 13h e 14h do dia 25/12/2020	18.0
Morrinhos	Entre 15h e 16h do dia 25/12/2020	8.4
Goiás	Entre 16h e 17h do dia 25/12/2020	48.6
Luziânia	Entre 17h e 18h do dia 25/12/2020	17.4
Posse	Entre 17h e 18h do dia 25/12/2020	33.8

Nas tabelas a seguir são apresentados os acumulados em 24 horas registrados pelo INMET. O maior acumulado foi registrado em Goiânia entre a manhã do dia 24 e a manhã do dia 25 de dezembro, com total de 79,0 mm, que corresponde a aproximadamente 27% da média para o mês.

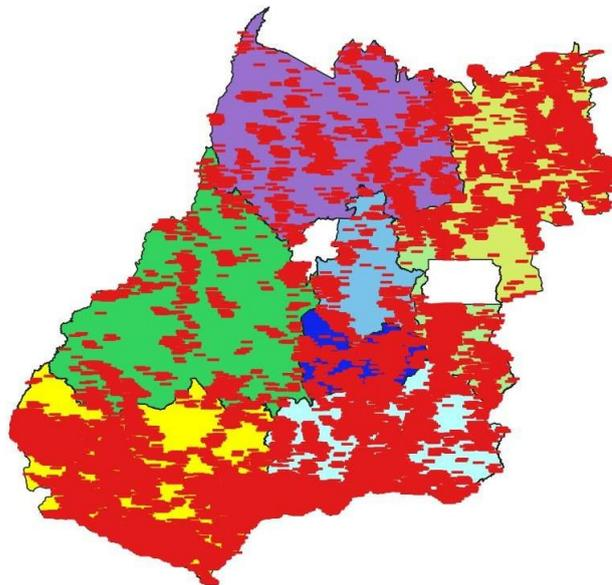
Tabela 2 – Precipitação acumulada entre 09h do dia 22 e 09h do dia 23 de dezembro de 2020. FONTE: INMET

Estação	Precipitação Acumulada(mm)
CRISTALINA	56.0
PIRES DO RIO	51.4
CAIAPÔNIA	43.4
ITAPACI	39.4
GOIANIA - AEROPORTO	30.0
IPAMERI	30.0

Tabela 3 – Precipitação acumulada entre 09h do dia 23 e 09h do dia 24 de dezembro de 2020. FONTE: INMET

Estação	Precipitação Acumulada(mm)
PIRENOPOLIS	51.0
IPAMERI	48.0
POSSE	47.6
MONTE ALEGRE DE GOIAS	42.8

Tabela 4 – Precipitação acumulada entre 09h do dia 24 e 09h do dia 25 de dezembro de 2020. FONTE: INMET

Estação	Precipitação Acumulada(mm)
GOIANIA	79.0
MORRINHOS	66.0
POSSE	58.4
PARAUNA	42.8
ARAGARCAS	36.0
GOIANIA - AEROPORTO	32.0

Tabela 5 – Precipitação acumulada entre 09h do dia 25 e 09h do dia 26 de dezembro de 2020. FONTE: INMET

Estação	Precipitação Acumulada(mm)
GOIÁS	64.4
LUZIANIA	40.2
POSSE	38.4
PIRES DO RIO	33.0
IPAMERI	32.0

## 1.2. Abrangência do Evento

A seguir são apresentadas as imagens realçadas do satélite GOES-16 entre as 09h00 do dia 22 e 03h00 do dia 26 de dezembro de 2020. Nestas imagens é possível observar o desenvolvimento das instabilidades associadas à circulação do VCAN.

### 09h00 - 22 de Dezembro de 2020 - BRT



Figura 4 – Imagens realçadas do satélite GOES-16 das 09h00 do dia 22 de Dezembro de 2020.  
FONTE: Cptec/INPE.

### 12h00 - 22 de Dezembro de 2020 - BRT

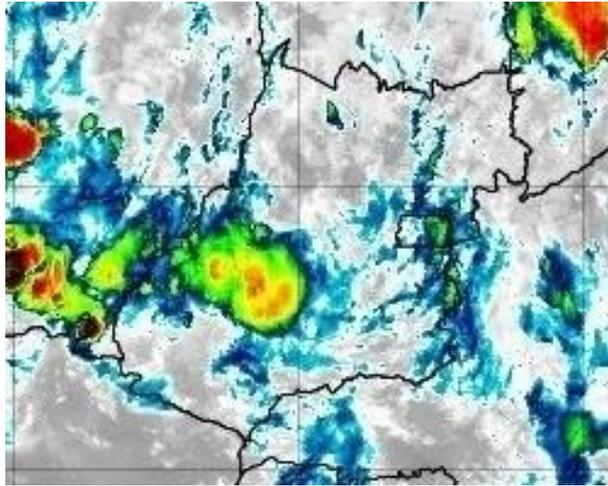

Figura 5 – Imagens realçadas do satélite GOES-16 das 12h00 do dia 22 de Dezembro de 2020.  
FONTE: Cptec/INPE.

**15h00 - 22 de Dezembro de 2020 - BRT**

Figura 6 – Imagens realçadas do satélite GOES-16 das 15h00 do dia 22 de Dezembro de2020.  
FONTE: Cptec/INPE.

**18h00 - 22 de Dezembro de 2020 - BRT**

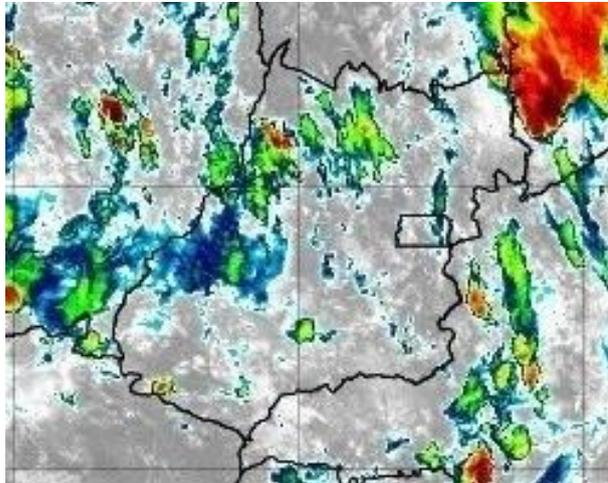
Figura 7 – Imagens realçadas do satélite GOES-16 das 18h00 do dia 22 de Dezembro de2020.  
FONTE: Cptec/INPE.

**21h00 - 22 de Dezembro de 2020 - BRT**

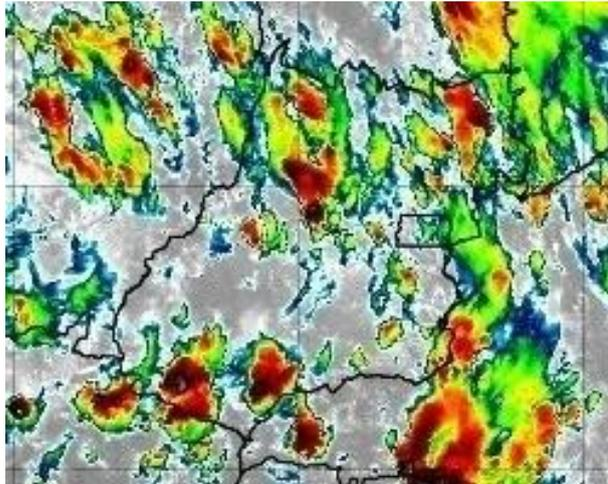
Figura 8 – Imagens realçadas do satélite GOES-16 das 21h00 do dia 22 de Dezembro de2020.  
FONTE: Cptec/INPE.

**0h00 - 23 de Dezembro de 2020 - BRT**

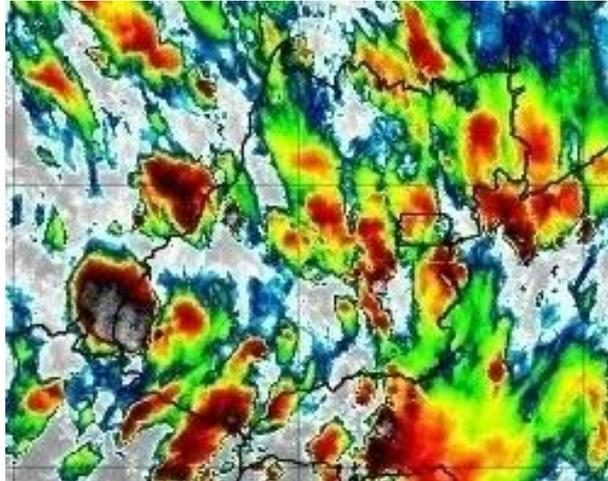
Figura 9 – Imagens realçadas do satélite GOES-16 das 0h00 do dia 23 de Dezembro de2020.  
FONTE: Cptec/INPE.

**3h00 - 23 de Dezembro de 2020 - BRT**

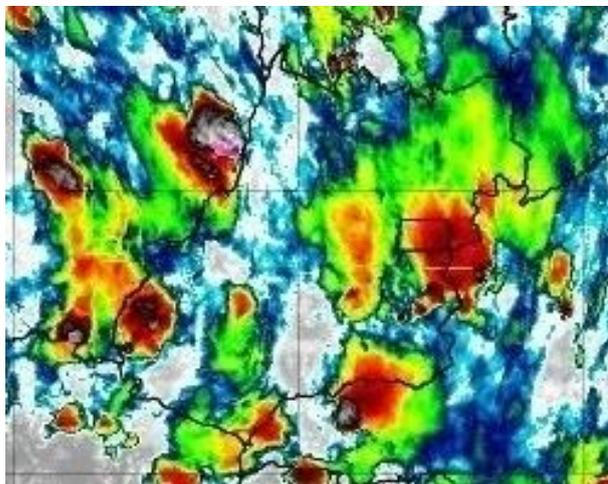
Figura 10 – Imagens realçadas do satélite GOES-16 das 3h00 do dia 23 de Dezembro de2020.  
FONTE: Cptec/INPE.

**6h00 - 23 de Dezembro de 2020 - BRT**

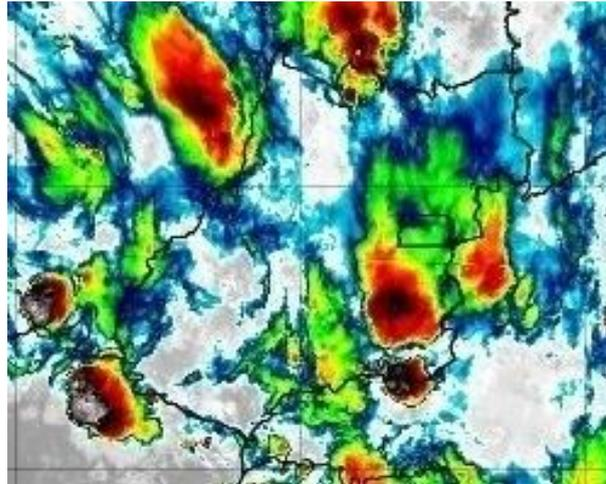
Figura 11 – Imagens realçadas do satélite GOES-16 das 6h00 do dia 23 de Dezembro de2020.  
FONTE: Cptec/INPE.

**9h00 - 23 de Dezembro de 2020 - BRT**

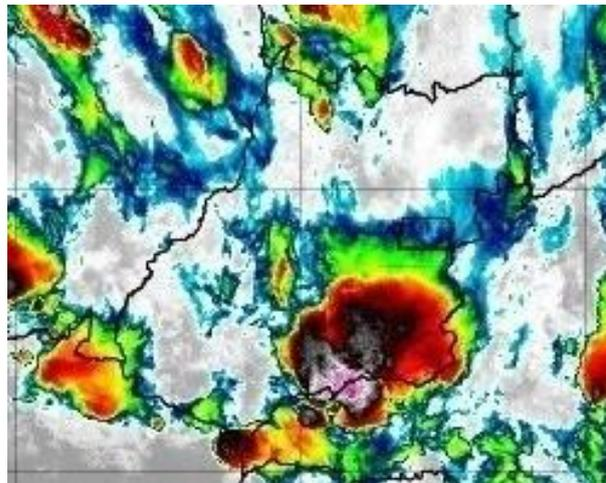
Figura 12 – Imagens realçadas do satélite GOES-16 das 9h00 do dia 23 de Dezembro de2020.  
FONTE: Cptec/INPE.

**12h00 - 23 de Dezembro de 2020 - BRT**

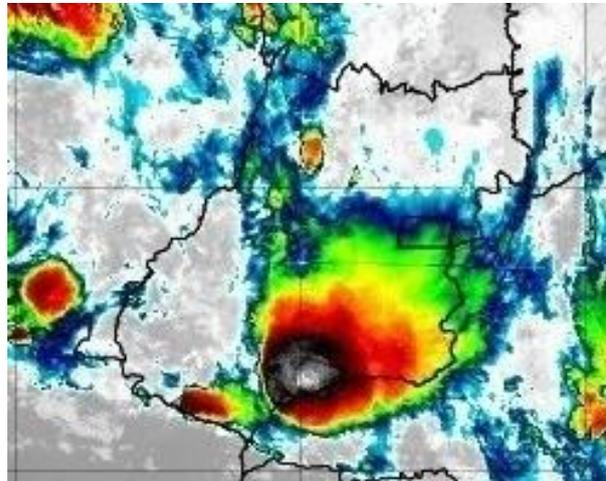
Figura 13 – Imagens realçadas do satélite GOES-16 das 12h00 do dia 23 de Dezembro de2020.  
FONTE: Cptec/INPE.

**15h00 - 23 de Dezembro de 2020 - BRT**

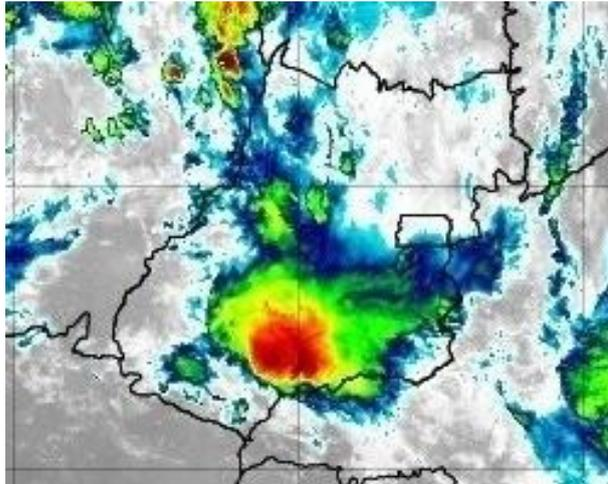
Figura 14 – Imagens realçadas do satélite GOES-16 das 15h00 do dia 23 de Dezembro de2020.  
FONTE: Cptec/INPE.

**18h00 - 23 de Dezembro de 2020 - BRT**

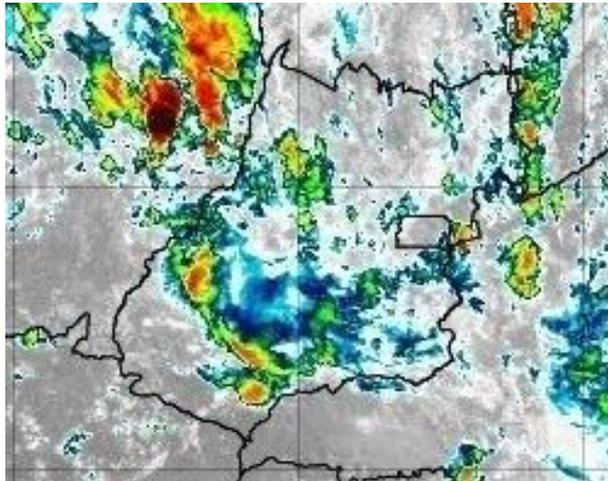
Figura 15 – Imagens realçadas do satélite GOES-16 das 18h00 do dia 23 de Dezembro de2020.  
FONTE: Cptec/INPE.

**21h00 - 23 de Dezembro de 2020 - BRT**

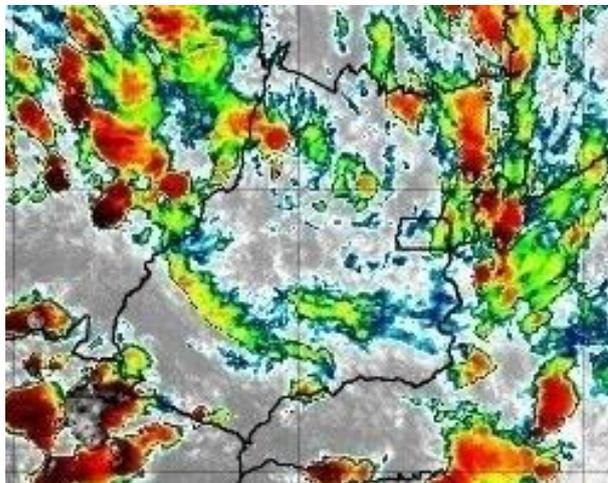
Figura 16 – Imagens realçadas do satélite GOES-16 das 21h00 do dia 23 de Dezembro de2020.  
FONTE: Cptec/INPE.

**0h00 - 24 de Dezembro de 2020 - BRT**

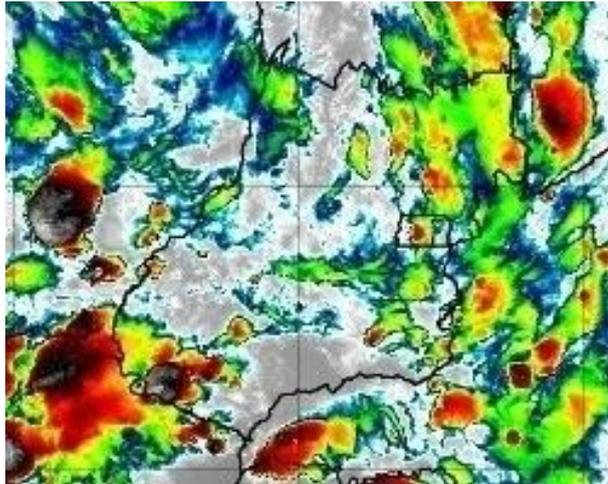
Figura 17 – Imagens realçadas do satélite GOES-16 das 0h00 do dia 24 de Dezembro de2020.  
FONTE: Cptec/INPE.

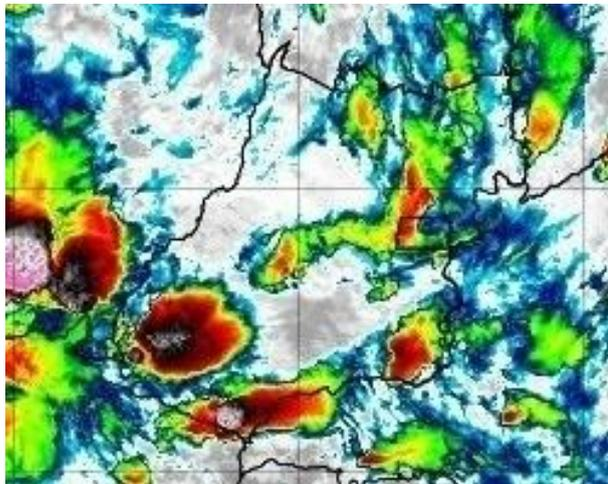

**3h00 - 24 de Dezembro de 2020 - BRT**

Figura 18 – Imagens realçadas do satélite GOES-16 das 3h00 do dia 24 de Dezembro de2020.  
FONTE: Cptec/INPE.

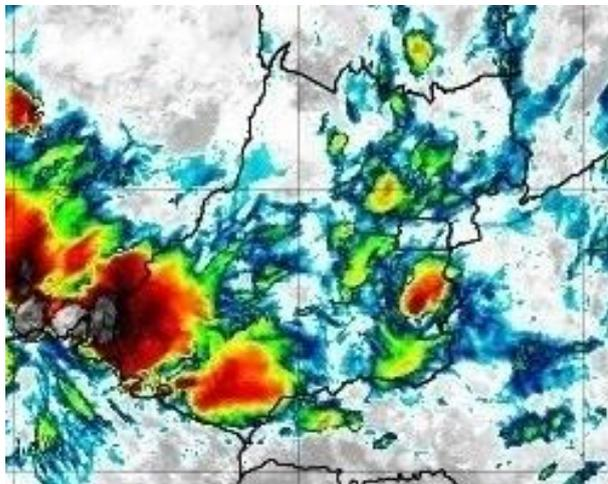
**6h00 - 24 de Dezembro de 2020 - BRT**

Figura 19 – Imagens realçadas do satélite GOES-16 das 6h00 do dia 24 de Dezembro de2020.  
FONTE: Cptec/INPE.

**9h00 - 24 de Dezembro de 2020 - BRT**

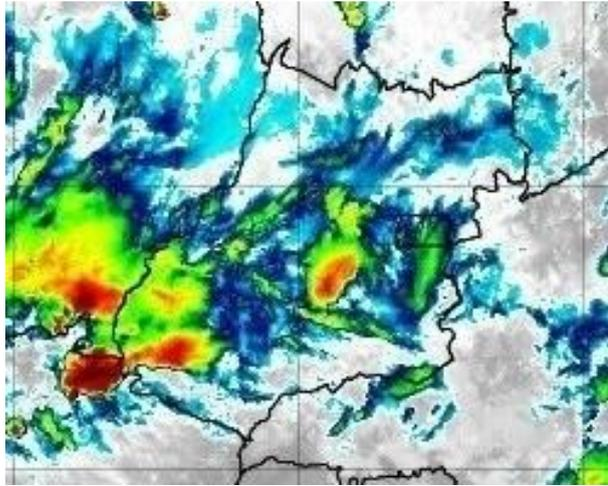
Figura 20 – Imagens realçadas do satélite GOES-16 das 9h00 do dia 24 de Dezembro de2020.  
FONTE: Cptec/INPE.

**12h00 - 24 de Dezembro de 2020 - BRT**

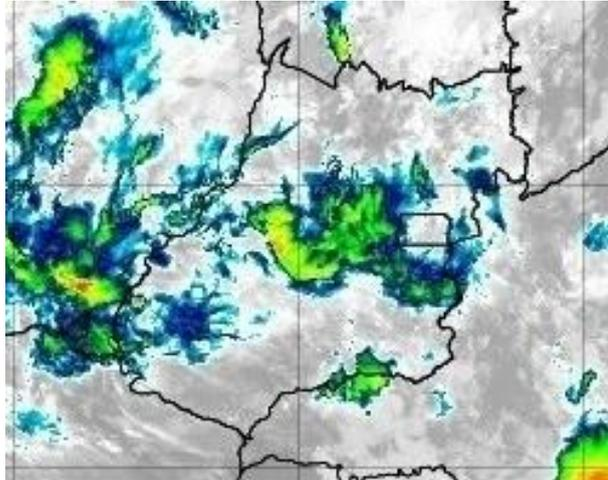
Figura 21 – Imagens realçadas do satélite GOES-16 das 12h00 do dia 24 de Dezembro de2020.  
FONTE: Cptec/INPE.

**15h00 - 24 de Dezembro de 2020 - BRT**

Figura 22 – Imagens realçadas do satélite GOES-16 das 15h00 do dia 24 de Dezembro de2020.  
FONTE: Cptec/INPE.

**18h00 - 24 de Dezembro de 2020 - BRT**

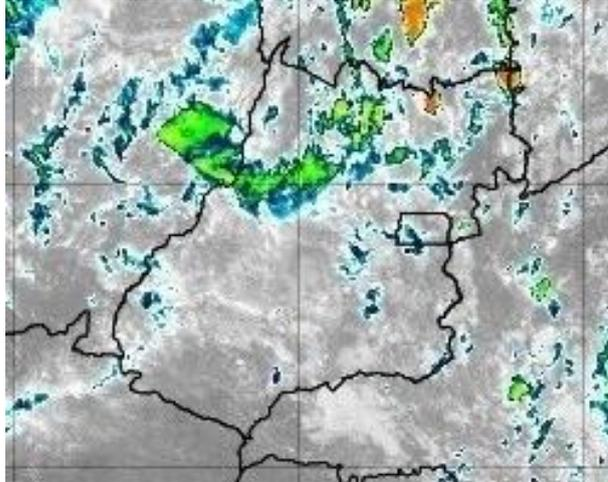
Figura 23 – Imagens realçadas do satélite GOES-16 das 18h00 do dia 24 de Dezembro de2020.  
FONTE: Cptec/INPE.

**21h00 - 24 de Dezembro de 2020 - BRT**

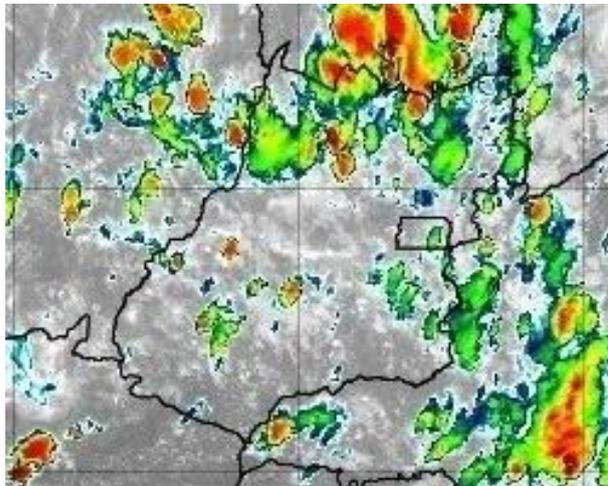
Figura 24 – Imagens realçadas do satélite GOES-16 das 21h00 do dia 24 de Dezembro de2020.  
FONTE: Cptec/INPE.

**0h00 - 25 de Dezembro de 2020 - BRT**

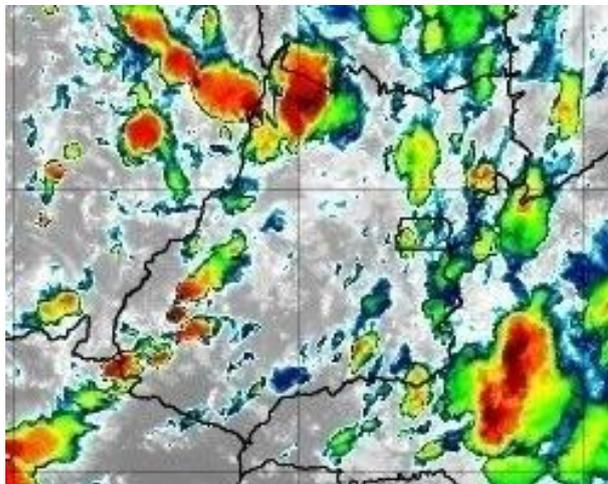
Figura 25 – Imagens realçadas do satélite GOES-16 das 0h00 do dia 25 de Dezembro de2020.  
FONTE: Cptec/INPE.

**3h00 - 25 de Dezembro de 2020 - BRT**

Figura 26 – Imagens realçadas do satélite GOES-16 das 3h00 do dia 25 de Dezembro de2020.  
FONTE: Cptec/INPE.

---

## 2. Classificação COBRADE

O COBRADE (Classificação e Codificação Brasileira de Desastres) foi criado como intuito de adequar a classificação brasileira à classificação utilizada pela ONU na classificação de desastres e nivelar o país aos demais organismos de gestão de desastres do mundo.

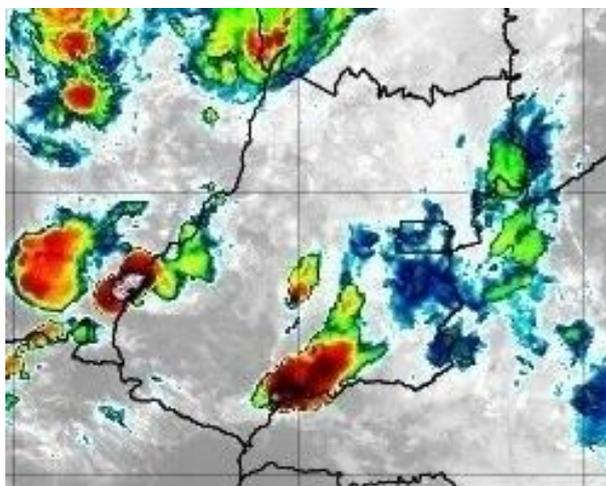
Baseados nos dados analisados nos itens anteriores, podemos classificar o evento ocorrido sobre a área de concessão da ENEL DISTRIBUIÇÃO GOIÁS como Zona de Convergência (Código 1.3.1.2.0).

### 3. Resumo do Evento

Nuvens de tempestade associadas a formação e manutenção de uma Zona de Convergência do Atlântico Sul atuaram sobre o estado de Goiás entre a manhã do dia 22 e amadruçada do dia 26 de dezembro de 2020.

O sistema de detecção da Earth Networks registrou 94109 descargas atmosféricas sobre a área de concessão da ENEL em Goiás entre as 07h45 do dia 22 e 02h00 do dia 26 de dezembro de 2020.

Várias estações do INMET registraram chuva forte durante a influência da Zona de Convergência do Atlântico Sul. Em Goiânia foram acumulados o equivalente a 27% da média para todo o mês entre a manhã do dia 24 e a manhã do dia 25 de dezembro.

Tabela 6 – Resumo do evento Regional Rio Verde

Número/Código do Evento	
Número/Código do Relatório	
Descrição	Região ligada à tempestade causada por uma zona de baixa pressão atmosférica, provocando forte deslocamento de massas de ar, vendavais, chuvas intensas e possível queda de granizo.
Código COBRADE	1.3.1.2.0 – Zona de Convergência
Hora início do evento	07h40 do dia 22 de dezembro de 2020
Hora fim do evento	02h00 do dia 26 de dezembro de 2020
Abrangência	Regional Rio Verde

Tabela 7 – Resumo do evento Regional Morrinhos

Número/Código do Evento	
Número/Código do Relatório	
Descrição	Região ligada à tempestade causada por uma zona de baixa pressão atmosférica, provocando forte deslocamento de massas de ar, vendavais, chuvas intensas e possível queda de granizo.
Código COBRADE	1.3.1.2.0 – Zona de Convergência
Hora início do evento	11h00 do dia 22 de dezembro de 2020
Hora de fim do evento	21h15 do dia 25 de dezembro de 2020
Abrangência	Regional Morrinhos

Tabela 8 – Resumo do evento Regional Metropolitana e Goiânia

Número/Código do Evento	
Número/Código do Relatório	
Descrição	Região ligada à tempestade causada por uma zona de baixa pressão atmosférica, provocando forte deslocamento de massas de ar, vendavais, chuvas intensas e possível queda de granizo.
Código COBRADE	1.3.1.2.0 – Zona de Convergência
Hora início do evento	12h00 do dia 22 de dezembro de 2020
Hora de fim do evento	22h00 do dia 25 de dezembro de 2020
Abrangência	Regional Metropolitana e Goiânia

Tabela 9 – Resumo do evento Regional Iporá

Número/Código do Evento	
Número/Código do Relatório	
Descrição	Região ligada à tempestade causada por uma zona de baixa pressão atmosférica, provocando forte deslocamento de massas de ar, vendavais, chuvas intensas e possível queda de granizo.
Código COBRADE	1.3.1.2.0 – Zona de Convergência
Hora início do evento	07h30 do dia 22 de dezembro de 2020
Hora de fim do evento	22h00 do dia 25 de dezembro de 2020
Abrangência	Regional Iporá

Tabela 10 – Resumo do evento Regional Luziânia

Número/Código do Evento	
Número/Código do Relatório	
Descrição	Região ligada à tempestade causada por uma zona de baixa pressão atmosférica, provocando forte deslocamento de massas de ar, vendavais, chuvas intensas e possível queda de granizo.
Código COBRADE	1.3.1.2.0 – Zona de Convergência
Hora início do evento	12h30 do dia 22 de dezembro de 2020
Hora de fim do evento	00h30 do dia 26 de dezembro de 2020
Abrangência	Regional Luziânia

Tabela 11 – Resumo do evento Regional Anápolis

Número/Código do Evento	
Número/Código do Relatório	
Descrição	Região ligada à tempestade causada por uma zona de baixa pressão atmosférica, provocando forte deslocamento de massas de ar, vendavais, chuvas intensas e possível queda de granizo.
Código COBRADE	1.3.1.2.0 – Zona de Convergência
Hora início do evento	11h30 do dia 22 de dezembro de 2020
Hora de fim do evento	00h30 do dia 26 de dezembro de 2020
Abrangência	Regional Anápolis

Tabela 12 – Resumo do evento Regional Uruaçu

Número/Código do Evento	
Número/Código do Relatório	
Descrição	Região ligada à tempestade causada por uma zona de baixa pressão atmosférica, provocando forte deslocamento de massas de ar, vendavais, chuvas intensas e possível queda de granizo.
Código COBRADE	1.3.1.2.0 – Zona de Convergência
Hora início do evento	09h00 do dia 22 de dezembro de 2020
Hora de fim do evento	00h30 do dia 26 de dezembro de 2020
Abrangência	Regional Uruaçu

Tabela 13 – Resumo do evento Regional Formosa

Número/Código do Evento	
Número/Código do Relatório	
Descrição	Região ligada à tempestade causada por uma zona de baixa pressão atmosférica, provocando forte deslocamento de massas de ar, vendavais, chuvas intensas e possível queda de granizo.
Código COBRADE	1.3.1.2.0 – Zona de Convergência
Hora início do evento	11h00 do dia 22 de dezembro de 2020
Hora de fim do evento	22h30 do dia 25 de dezembro de 2020
Abrangência	Regional Formosa

## 4. Referências

- RMets Royal Meteorological Society – Beaufort Scale -  
<https://www.rmets.org/weather-and-climate/observing/beaufort-scale>
- Instituto Nacional de Meteorologia (INMET) - <http://www.inmet.gov.br>
- Cptec/INPE  
<https://www.cptec.inpe.br/>
- Centro de Hidrografia da Marinha do Brasil -  
<https://www.marinha.mil.br/chm/>
- Meteorology Glossary - American Meteorological Society -  
<http://glossary.ametsoc.org/>



# Anexos

## A.1. Carta Sinótica



Figura A1 - Carta sinótica da Marinha do Brasil para as 1200Z do dia 22 de dezembro de 2020 (09h00 do dia 22 de dezembro de 2020, hora local).



LEGENDA			
	Frente Fria	<b>A</b>	Alta Pressão
	Frente Quente	<b>B</b>	Baixa Pressão
	Instabilidade		Zona de Convergência

Figura A2 - sinótica da Brasil para dia 23 de dezembro de 2020 (09h00 do dia 23 de dezembro de 2020, hora local).

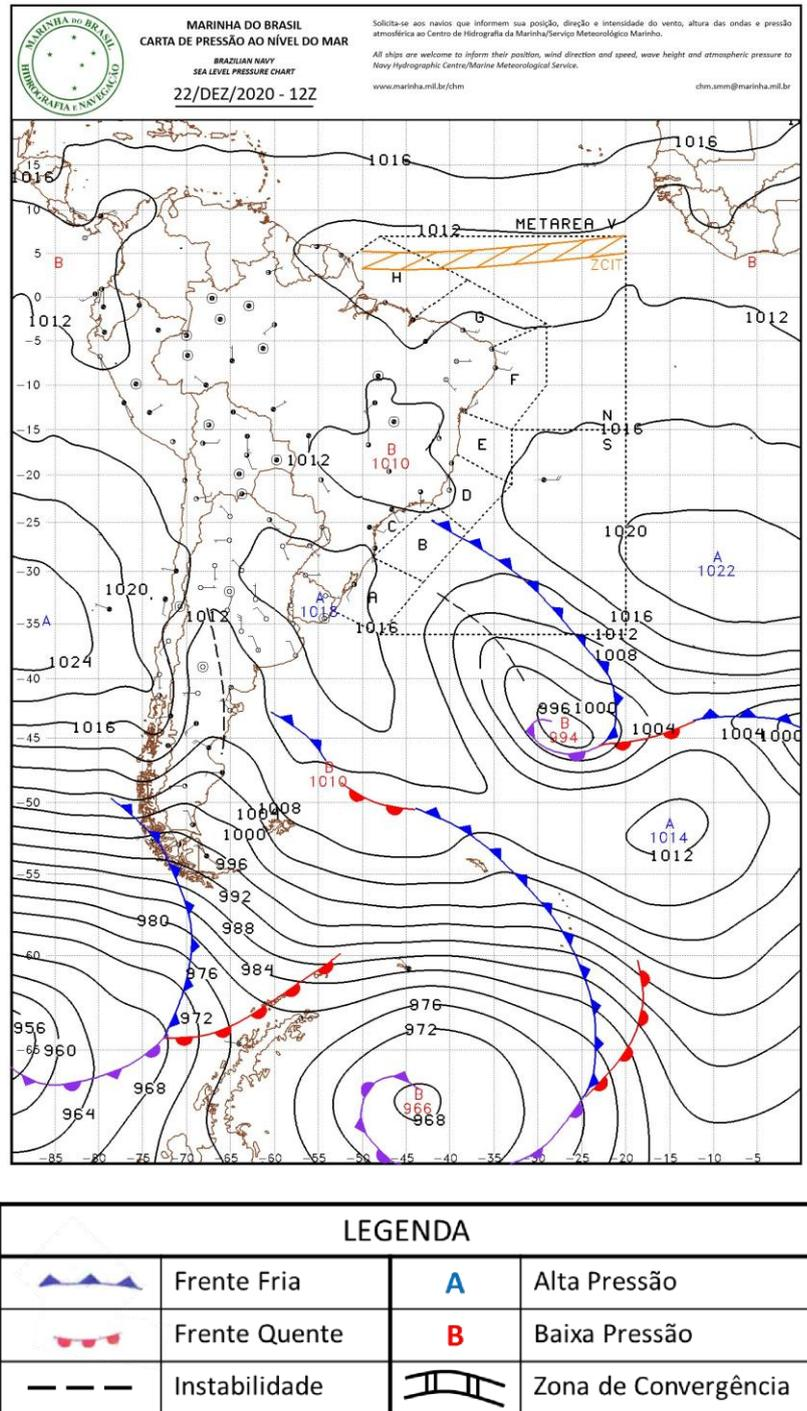
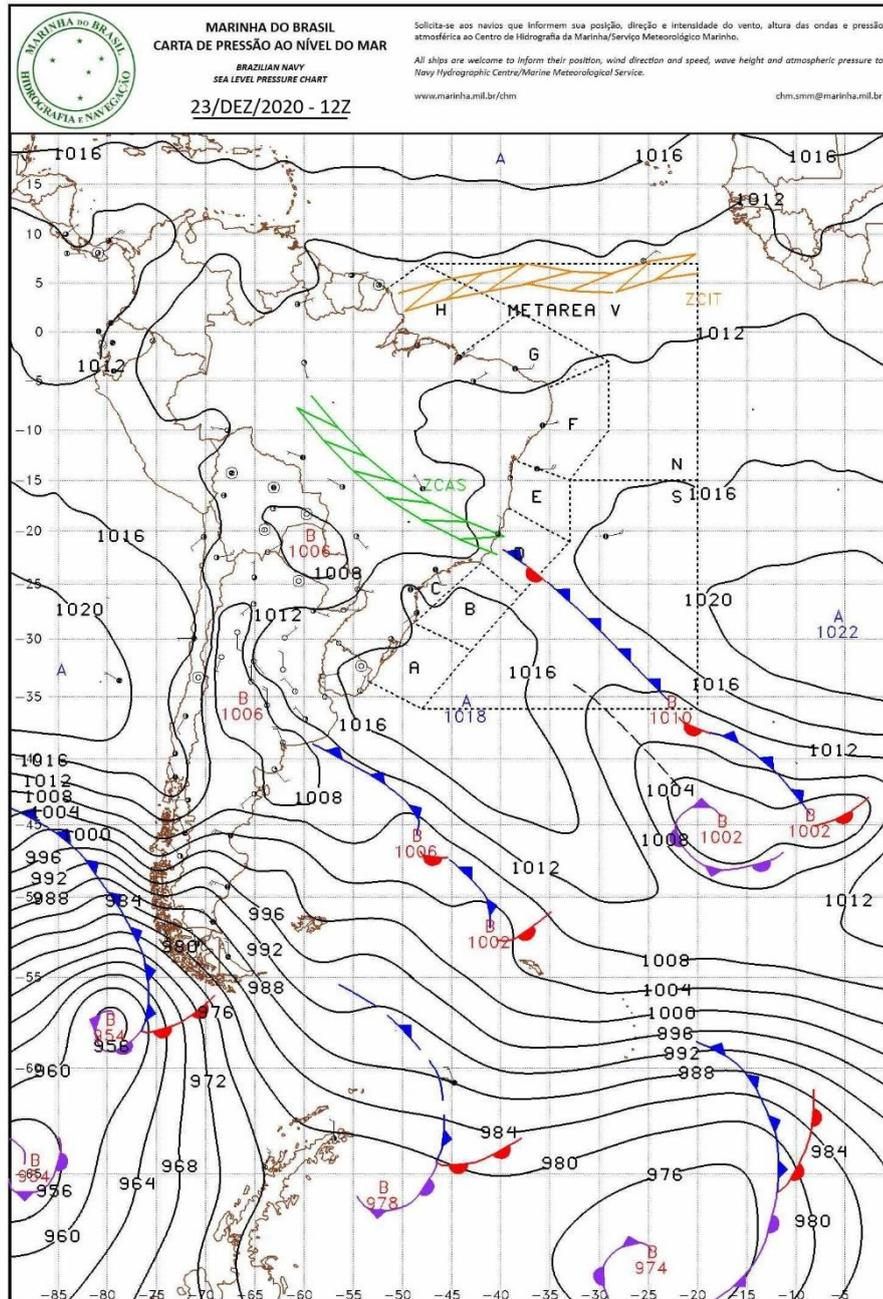
Carta Marinha do as 1200Z do

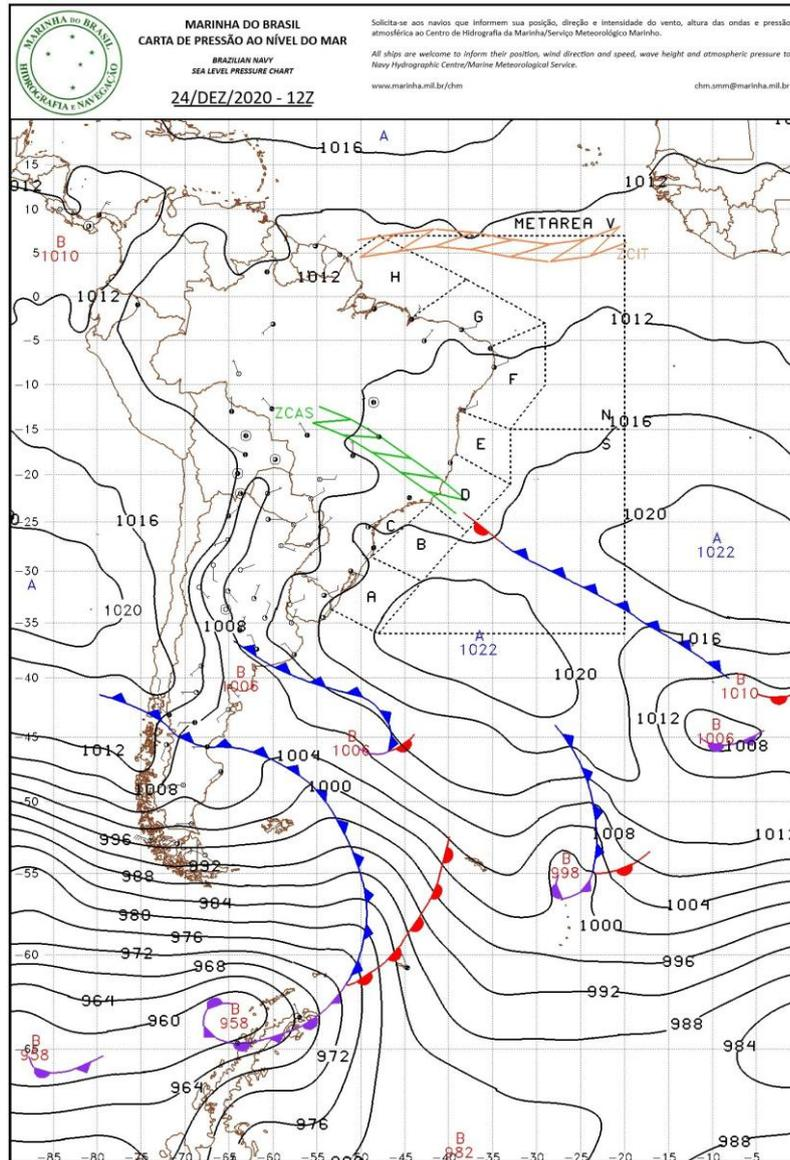

LEGENDA			
	Frente Fria	<b>A</b>	Alta Pressão
	Frente Quente	<b>B</b>	Baixa Pressão
	Instabilidade		Zona de Convergência

Figura A3 - Carta sinótica da Marinha do Brasil para as 1200Z do dia 24 de dezembro de 2020 (09h00 do dia 24 de dezembro de 2020, hora local).

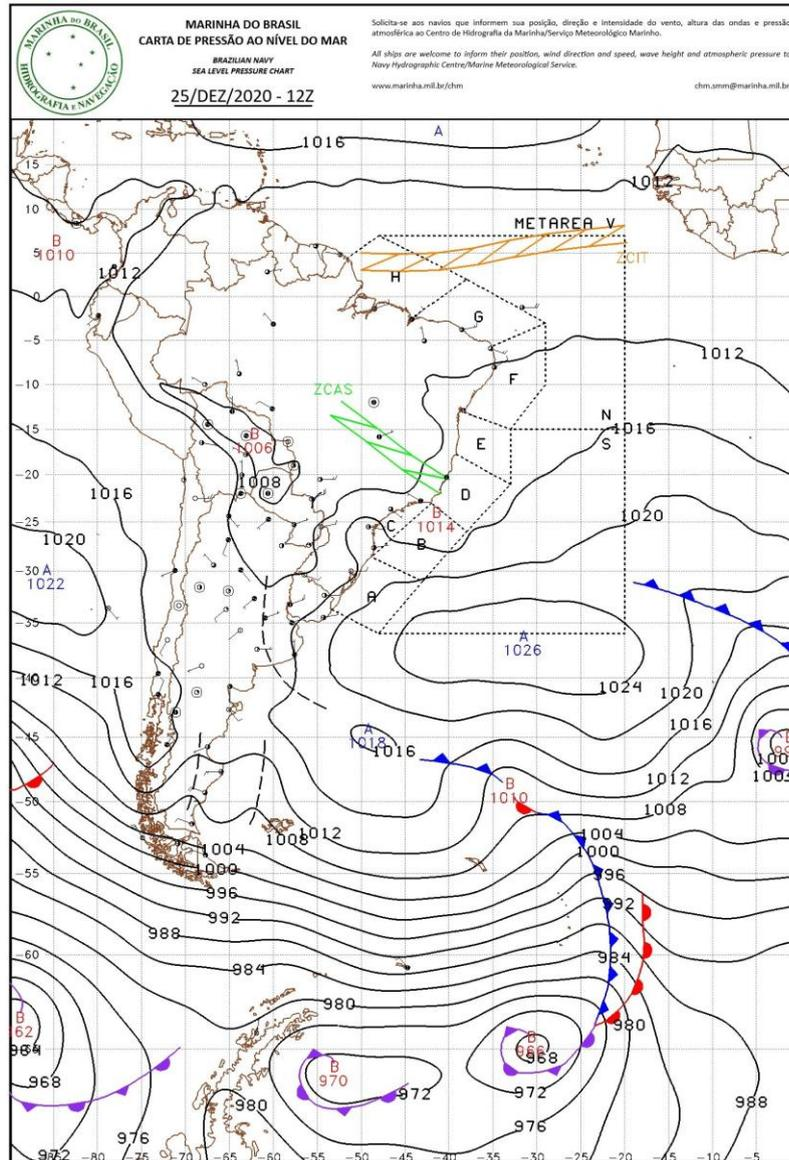

LEGENDA			
	Frente Fria	<b>A</b>	Alta Pressão
	Frente Quente	<b>B</b>	Baixa Pressão
	Instabilidade		Zona de Convergência

Figura A4 - Carta sinótica da Marinha do Brasil para as 1200Z do dia 25 de dezembro de 2020 (09h00 do dia 25 de dezembro de 2020, hora local).

## A.2. Notícias associadas

- Chuva alaga ruas de Valparaíso de Goiás <https://globoplay.globo.com/v/9123897/>

Bianca Lobo Silva  
Meteorologista  
CREA 5063840461